

JUN 25 1963



# Technical Note

186

---

## TABULATION OF PUBLISHED DATA ON SOVIET ELECTRON DEVICES

CHARLES P. MARSDEN



---

U. S. DEPARTMENT OF COMMERCE  
NATIONAL BUREAU OF STANDARDS

## THE NATIONAL BUREAU OF STANDARDS

### Functions and Activities

The functions of the National Bureau of Standards are set forth in the Act of Congress, March 3, 1901, as amended by Congress in Public Law 619, 1950. These include the development and maintenance of the national standards of measurement and the provision of means and methods for making measurements consistent with these standards; the determination of physical constants and properties of materials; the development of methods and instruments for testing materials, devices, and structures; advisory services to government agencies on scientific and technical problems; invention and development of devices to serve special needs of the Government; and the development of standard practices, codes, and specifications. The work includes basic and applied research, development, engineering, instrumentation, testing, evaluation, calibration services, and various consultation and information services. Research projects are also performed for other government agencies when the work relates to and supplements the basic program of the Bureau or when the Bureau's unique competence is required. The scope of activities is suggested by the listing of divisions and sections on the inside of the back cover.

### Publications

The results of the Bureau's research are published either in the Bureau's own series of publications or in the journals of professional and scientific societies. The Bureau publishes three periodicals available from the Government Printing Office: The Journal of Research, published in four separate sections, presents complete scientific and technical papers; the Technical News Bulletin presents summary and preliminary reports on work in progress; and the Central Radio Propagation Laboratory Ionospheric Predictions provides data for determining the best frequencies to use for radio communications throughout the world. There are also five series of nonperiodical publications: Monographs, Applied Mathematics Series, Handbooks, Miscellaneous Publications, and Technical Notes.

A complete listing of the Bureau's publications can be found in National Bureau of Standards Circular 460, Publications of the National Bureau of Standards, 1901 to June 1947 (\$1.25), and the Supplement to National Bureau of Standards Circular 460, July 1947 to June 1957 (\$1.50), and Miscellaneous Publication 240, July 1957 to June 1960 (includes Titles of Papers Published in Outside Journals 1950 to 1959) (\$2.25); available from the Superintendent of Documents, Government Printing Office, Washington 25, D.C.

# NATIONAL BUREAU OF STANDARDS

*Technical Note 186*

ISSUED JUNE 3, 1963

## TABULATION OF PUBLISHED DATA ON SOVIET ELECTRON DEVICES

Charles P. Marsden

NBS Technical Notes are designed to supplement the Bureau's regular publications program. They provide a means for making available scientific data that are of transient or limited interest. Technical Notes may be listed or referred to in the open literature.

## Foreword

This tabulation of published data on Soviet electron devices has been prepared as part of the National Bureau of Standards Electron Devices Data Service. Established in 1948 to provide technical data on radio tubes to members of the Bureau staff, the service has since been extended to other scientists and engineers in government and industry. In the course of the program, a large volume of information on tubes, transistors, diodes, and other electron devices has been accumulated on punched cards. To make this information more readily available, a system has been worked out for automatically tabulating the data in handbook form. Previous tabulations include Tabulation of Data on Receiving Tubes, NBS Handbook 68 (1959); Tabulation of Data on Microwave Tubes, NBS Handbook 70 (1961); and Diode Source Book (published by Semiconductor Products magazine, (1961)).

The present tabulation is the result of compilation efforts extending over the past four years. All the included information was taken from published specifications, and every effort has been made to ensure accuracy and completeness. However, the Bureau cannot assume responsibility for omissions nor for results obtained with these data.

A. V. Astin, Director.

## Contents

	Page
1. Introduction, . . . . .	1
2. Description of the Tabulation . . . . .	1
3. Figure 1 Organization of the Tabulation . . . . .	2
4. Terminology Used in the Tabulation, . . . . .	3
4.1 Column Headings, . . . . .	3
4.2 Bulb Size, . . . . .	3
4.3 Code . . . . .	4
Numerical Listing, . . . . .	8
Receiving Tubes, . . . . .	20
Power Tubes, . . . . .	30
Rectifier Tubes, . . . . .	35
Voltage Regulator Tubes, . . . . .	36
Current Regulator Tubes, . . . . .	36
Thyratrons . . . . .	37
Cathode Ray Tubes, . . . . .	39
Microwave Tubes, . . . . .	42
Transistors, . . . . .	43
Diodes - Rectifier . . . . .	50
Diodes - Power Rectifier . . . . .	53
Diodes - Regulators, . . . . .	53
Diodes - Mixer and Detector, . . . . .	54
Diodes - Photoconductive . . . . .	55
Phototubes and Photo multipliers . . . . .	58
Flash Tubes, . . . . .	60
Thermocouple Tubes . . . . .	60
Thermistors, . . . . .	61
Strobotrons, . . . . .	62
Counter Tubes, . . . . .	63
Discharge Tubes, . . . . .	64
Decatrons, . . . . .	64
Light Amplifiers . . . . .	64
Basing Connections . . . . .	65



# FIG. 1

GROUP I, NUMERICAL																										
TYPE NUMBER	KIND	TYPE	TABLE NO.	SIMILAR TYPES		COST SPEC. NO.																				
GROUP II, RECEIVING																										
TYPE NUMBER	KIND	TYPE	BULB	USE	CATHODE	E <sub>f</sub> v	I <sub>f</sub> ma	MAXIMUM			TYPICAL					CAPACITY		f <sub>max</sub> mc	BASE							
								E <sub>b</sub> v	I <sub>b</sub> ma	P <sub>d</sub> w	E <sub>b</sub> v	E <sub>g2</sub> v	E <sub>g1</sub> v	I <sub>b</sub> ma	I <sub>g2</sub> ma	S <sub>m</sub> μmha/100	μ			R <sub>p</sub> Ω	IN pf	OUT pf				
GROUP III, POWER																										
TYPE NUMBER	KIND	TYPE	BULB	USE	CATHODE	E <sub>f</sub> v	I <sub>f</sub> ma	MAXIMUM			TYPICAL					CAPACITY		f <sub>max</sub> mc	BASE							
								E <sub>b</sub> v	I <sub>b</sub> ma	P <sub>d</sub> w	E <sub>b</sub> v	E <sub>g2</sub> v	E <sub>g1</sub> v	I <sub>b</sub> ma	I <sub>g2</sub> ma	S <sub>m</sub> μmha/100	μ			R <sub>p</sub> Ω	IN pf	OUT pf				
GROUP IV, RECTIFIER TUBES																										
TYPE NUMBER	KIND	TYPE	BULB	GAS	CATHODE	E <sub>f</sub> v	I <sub>f</sub> ma	MAXIMUM		TYPICAL																
								E <sub>b</sub> v	I <sub>b</sub> ma	E <sub>b</sub> v	I <sub>b</sub> ma															
GROUP V, VOLTAGE REGULATOR TUBES																										
TYPE NUMBER	KIND	GAS		CATH	VOLT. RANGE		CUR. RANGE		DIMEN		BASE															
		KIND	PRES	MAT'L	MAX	MIN	MAX	MIN	DIA.	LTH																
GROUP VI, CURRENT REGULATOR TUBES																										
TYPE NUMBER	KIND	TYPE	BULB	VOLT. RANGE		CUR. RANGE		BASE																		
				MAX	MIN	MAX	MIN																			
GROUP VII, THYRATRONS																										
TYPE NUMBER	KIND	BULB			CATHODE			MAXIMUM ANODE			AVG	MAXIMUM GRID					BASE									
		SHAPE	LTH	DIAM	GAS	KIND	E <sub>f</sub> v	I <sub>f</sub> ma	WARM-UP MIN. >SEC	PIV v		E <sub>f</sub> v	FIRING v	TUBE DROP v	PULSE I <sub>b</sub> ma	I <sub>b</sub> ma		BIAS v	INPUT RES KΩ	PULSE			LTH ms			
GROUP VIII, CATHODE RAY																										
TYPE NUMBER	METH. OF		DIMENSIONS		USE	CATHODE	TYPICAL						MAXIMUM		SCREEN		DEFL ANGLE degree	BASE								
	FOCUS	DEFL	DIAM	LENGTH			HEATER	E <sub>foc</sub> v	E <sub>A1</sub> Kv	E <sub>A2</sub> Kv	E <sub>A3</sub> Kv	E <sub>A4</sub> Kv	E <sub>C1</sub> v	I <sub>k</sub> μa	DEFL SENS mm/v	COL			PERS							
GROUP IX, MICROWAVE TUBES																										
TYPE NUMBER	KIND	FREQ		DUTY	CATHODE	MAXIMUM										COUPLING	DIMEN									
		MIN	MAX	CYL		E <sub>f</sub> v	I <sub>f</sub> ma	E <sub>b</sub> v	I <sub>b</sub> ma	P <sub>o</sub> mw	COL	E <sub>g</sub> v	HELIX v	GAIN db	NF db		VSWR	BAND WIDTH	MAG. FIELD GAUSS	LTH	DIAM	WT. g				
GROUP X, TRANSISTORS																										
TYPE NUMBER	KIND	MAXIMUM						TYPICAL			MAXIMUM			MINIMUM		TYP	MIN	MAXIMUM		FIG						
		V <sub>CB0</sub> v	V <sub>EB0</sub> v	V <sub>CE0</sub> v	I <sub>C</sub> ma	I <sub>E</sub> ma	I <sub>CB0</sub> μa	P <sub>C</sub> mw	K <sub>θ</sub> mw/°C	T <sub>i</sub> °C	COMMON	V <sub>C</sub> v	I ma	h <sub>11</sub> Ω	h <sub>12</sub> -5 10			h <sub>22</sub> μmho	h <sub>21</sub>		*f <sub>MAX</sub> mc	NF db	K <sub>M</sub> db	C <sub>ob</sub> pf	r <sub>b</sub> r <sub>c</sub> C	
GROUP XI, DIODES—RECTIFIERS																										
TYPE NUMBER	KIND	TYPE	MAXIMUM		MAXIMUM @ 25 °C			MAXIMUM			f <sub>max</sub> mc	FIG														
			I <sub>F</sub> ma	T <sub>opr</sub> °C	I <sub>S</sub> μa	PIV v	*MIN E <sub>F</sub> v	I <sub>F</sub> ma	I <sub>R</sub> μa	E <sub>r</sub> v			°T <sub>C</sub> °C													
GROUP XII, DIODES—POWER RECTIFIERS																										
TYPE NUMBER	KIND	TYPE	MAXIMUM			MAXIMUM E <sub>R</sub> IN VOLTS								COOLING												
			OPR TEMP °C	I <sub>f</sub> amp	E <sub>f</sub> v	I <sub>r</sub> ma	AVAILABLE FOR FOLLOWING SUBCLASSES								KIND	RATE	RADIATOR									
										15	30	45	50	55	70	80	100	110	150	2H	3H	4H	5H	6H	7H	8H

FIG. 1 CONT'D

GROUP XIII, DIODES - REGULATORS												
TYPE NUMBER	KIND	TYPE	MAXIMUM			TYPICAL			MAX Z Ω	TC %/°C	K <sub>θ</sub> mW/°C	FIG
			I <sub>Z</sub> mA	T <sub>Op</sub> °C	P <sub>Z</sub> mW	E <sub>Z</sub> V	ΔE <sub>Z</sub> %	I <sub>Z</sub> mA				

GROUP XIV, DIODES - MIXER & DETECTOR														
TYPE NUMBER	KIND	TYPE	MAXIMUM			FREQUENCY		MIN.	MAXIMUM				P <sub>BO</sub> ergs mW	FIG
			Z <sub>V</sub> kΩ	T <sub>Op</sub> °C	Z <sub>IF</sub> Ω	MIN G <sub>C</sub>	MAX G <sub>C</sub>	FM	NR	VSWR	NF dB	LC dB		

GROUP XV, DIODES - PHOTOCONDUCTIVE										
TYPE NUMBER	KIND	CATH AREA mm <sup>2</sup>	MIN. DARK RES. meg Ω	MAX. WORKING V	SENS. μA/lm	T. C. CURRENT %	SPEC. SENS.		TEMP.	
							MAX	CUTOFF μ	MIN	MAX

GROUP XVI, PHOTOTUBES & MULTIPLIERS																	
TYPE NUMBER	KIND	BULB	DIMEN.		CATHODE		MAXIMUM		Iamp/Lm		IOamp/Lm		IOar+IKamp/Lm		DYNODES		
			DIAM mm	LTH. mm	AREA cm <sup>2</sup>	SURF.	SENS. μA/l	E <sub>b</sub> V	I <sub>k</sub> μA	E <sub>b</sub> V	DARK I <sub>k</sub> AMP. EXP.	E <sub>b</sub> V	DARK I <sub>k</sub> AMP. EXP.	E <sub>b</sub> V	DARK I <sub>k</sub> AMP. EXP.	DESIGN	MAT'L

GROUP XVII, FLASH TUBES					
TYPE NUMBER	KIND	BULB SHAPE AND SIZE	MAXIMUM		TYP. TUBE DROP V
			VOLT. V	POWER W	

GROUP XVIII, THERMOCOUPLE							
TYPE NUMBER	KIND	DIMENSIONS		TYPICAL		RESPONSE sec	f <sub>max</sub> mc
		DIAM mm	LENGTH mm	I <sub>H</sub> mA	THERMO ELEC mV		

GROUP XIX, THERMISTORS											
TYPE NUMBER	KIND	USE	DIMEN		RESISTANCE		TEMP.		POWER		SENS Ω/W
			DIAM mm	LTH mm	SHAPE	MIN Ω	MAX Ω	T. C. %	MIN (-)°C	MAX (+)°C	

GROUP XX STROBOTRONS																		
TYPE NUMBER	DIMENSIONS			VOLTAGE			POWER		INTER RES Ω	FLASH CONDITIONS				LIGHT OUTPUT			LIFE	
	SHAPE	DIAM mm	LTH mm	MIN DROP V	OPER V	FIRING V	AVG W	PEAK kW		DISCHG CAP μf	TIME μs	FLASH FREQ cps	ENERGY J	FLASH c/sec	AVG c	PEAK c	NO OF FLSH	HRS

GROUP XXI, COUNTERS														
TYPE NUMBER	KIND	RADIATION	QUENCHING	CATHODE	DIMENSIONS		PLATEAU		MAXIMUM		TEMP		MIN R <sub>i</sub> meg Ω	FIG
					DIAM mm	LENGTH mm	MIN V	MAX V	RATE 10 <sup>3</sup> /min	PLATEAU WIDTH V	SCOPE % V	MIN -°C		

GROUP XXII DISCHARGE DIODES														
TYPE NUMBER	DIMEN		GAS	CATH		FIRING		PULSE			MIN RES meg Ω	MAX CAP pf	AMB. TEMP	
	LTH mm	DIAM mm		TYPE	KIND	MIN V	MAX V	I-amp μjoule	TIME sec	OPERATING FREQUENCY cps			MIN °C	MAX °C

GROUP XXIII DECATRONS												
TYPE NUMBER	KIND	VOLTAGES					TYP I <sub>b</sub> mA	PULSE		DIMEN		
		E <sub>b</sub> V	FIRING V	BIAS V	ORP V	OPER V		K <sub>1</sub> K <sub>2</sub> mA	TIME μs	RATE kc/s	LTH mm	OIA mm

GROUP XXIV LIGHT AMPLIFIERS									
TYPE NUMBER	KIND	K	SCRN COLOR	MAX. DIMEN		AMP μ	TYP E <sub>b</sub> V	RESOL	
				K	SCREEN			LINE PER mm	LINE PER mm

GROUP XXV, BASES																												
BASE NO	SECTION 1					SECTION 2					SEC. 4		DEFLECTION 1		DEFLECTION 2													
	H	H	K	g <sub>1</sub>	g <sub>2</sub>	g <sub>3</sub>	g <sub>4</sub>	g <sub>5</sub>	A	Sh	H	H	K	g <sub>1</sub>	g <sub>2</sub>	g <sub>3</sub>	A	A <sub>3</sub>	K	A	A <sub>5</sub>	D <sub>1</sub>	D <sub>2</sub>	D <sub>3</sub>	D <sub>4</sub>	D <sub>1</sub>	D <sub>2</sub>	D <sub>3</sub>

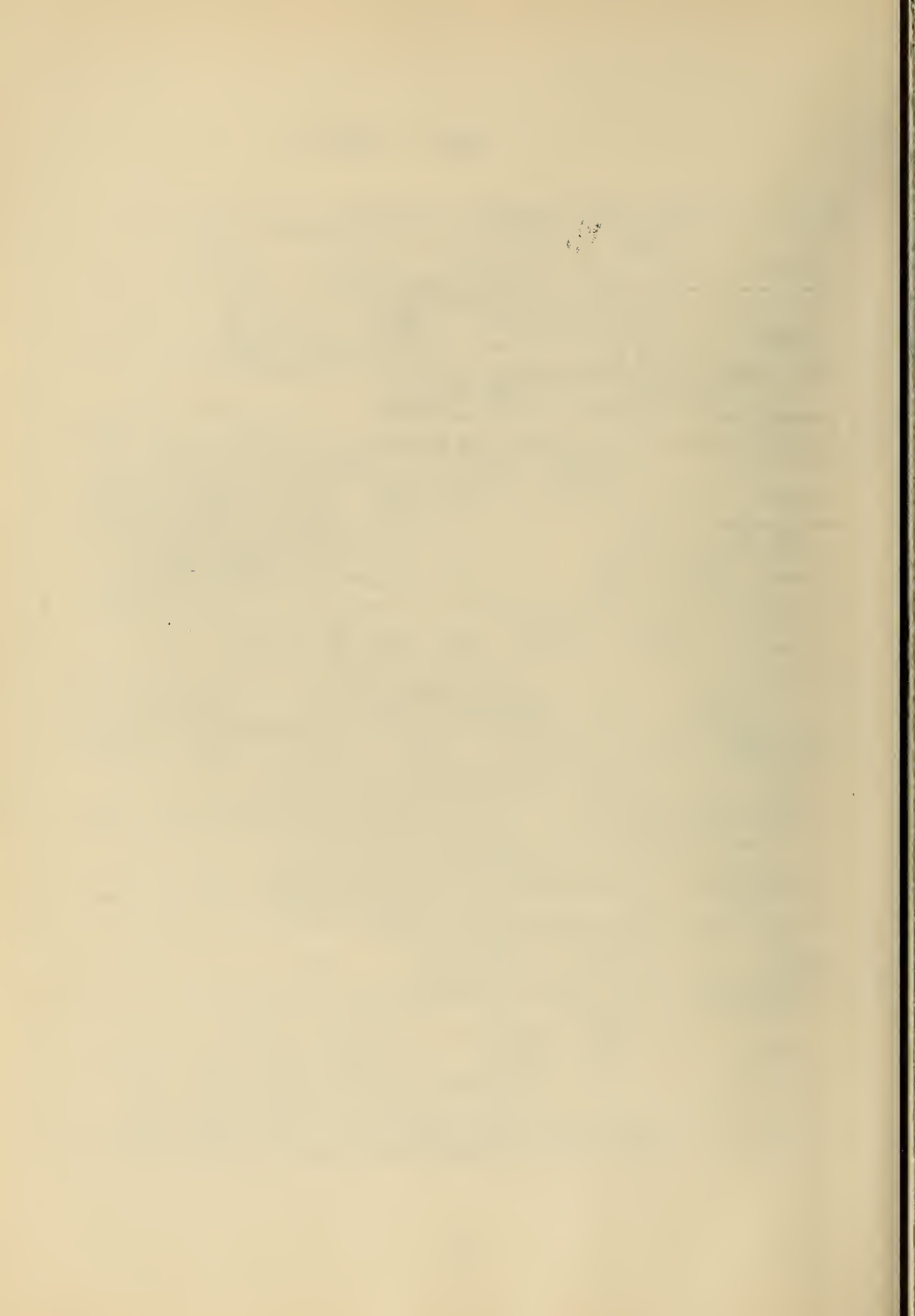



# Tabulation of Published Data on Soviet Electron Devices

Charles P. Marsden

This tabulation includes published data on Soviet electron devices as collected from various publications, mostly handbooks published by the various ministries and institutes of the USSR. Information is given on all active devices ranging from receiving to micro-wave devices, semiconductor devices, and various miscellaneous devices such as, for example, photographic flash tubes and thermistors.

## 1. Introduction

The increased circulation of published literature from the USSR and the importation of Soviet equipment has created a need for factual information on Soviet electron devices. To satisfy this need, the National Bureau of Standards Electron Devices Data Service has prepared the present tabulation in a format that could be reproduced directly from punched cards. The advantages of the use of these cards include the elimination of errors possible with other methods of reproduction, flexibility in adding or deleting information, and uniform columnar presentation.

The sources of the data are the various publications produced in the USSR and include books published by the various ministries, and technical magazines. This information has been intercompared and correlated to eliminate errors and thus assure that this tabulation is as accurate as possible. Because of this intercomparison, references for the data are not given, as data for any one type of device may have been derived from several sources.

## 2. Description of the Tabulation

In each group the type numbers are arranged in alpha-numerical order in which the first numerical part of the type number is the prime sorting means. Alphabetical prefixes are the secondary sorting means and alphabetical postfixes are the tertiary means. For example in the numerical list, these type numbers will be found in the following order:

V1-0.1/40	SG2S
VT1	TO-2
1A2P	2A1

Alphabetical sorting is performed according to the English alphabet rather than the Russian which was transliterated according to the recommended practice of the Library of Congress as shown below:

A	A	К	K	Т	T
Б	B	Л	L	У	U
В	V	М	M	Ф	F
Г	G	Н	N	Х	Kh
Д	D	О	O	Ц	Ts
Е	Ye	П	P	Ш	Sh
Ж	Zh	Р	R	Э	E
И	I	С	S		

This transliteration was necessary to put the information on punched cards and it is believed that it will cause little difficulty in use.

### 3. Organization of the Tabulation

The tabulation is divided into 24 groups, each with a different format and different columnar headings so that the maximum pertinent data may be included. These groups and their column headings are shown in Figure 1.

Group I is a numerical listing of all type numbers in the complete tabulation and also includes discontinued and obsolete types. All these types are defined by the same three-letter code to indicate the kind and type of tube. Furthermore, under the heading "Group No.", Roman numerals are used to show the group number under which the data for a type will be found. In the last column, the GOST (State National Standard) Specification Number (followed by the year of publication of the specification) is shown for the type number. These specifications include the information in and follow the format of the domestic military specifications.

This group is also an interchangeability list and known similar types are shown. Further, by means of the following symbol code, the manufacturing area and the obsolescence of the type are indicated.

- \* Domestic manufacture
- # European "
- И Russian "
- @ Obsolete or inactive

The above definitions of these symbols are pertinent only to their use in Group I. Due to the limitation of available symbols on listing equipment, these same symbols are used in the other groups but are then defined as shown at the end of the definitions under the paragraph entitled "Code" (p. 4).

The other groups have titles describing the particular class of

devices listed therein. As mentioned previously, the individual type numbers are arranged in the same alpha-numerical order.

Under each heading of the group format, the unit of measurement most common for the characteristic is shown. For example under the heading of Maximum Plate Current ( $I_p$ ), the unit in the heading is ma (milliamperes). However, where the  $I_p$  data are in amperes, the value will be tabulated with the number followed by the letter "A", e.g., 15A. All these changes of units are included in the list of alphabetical symbols under code on pages 3 to 5.

A blank in any column indicates that no value was given in the available data.

Group XXIV, "Bases", lists the basing connections for the particular "Base No." of the previous groups by a system compatible with punched cards.

Instead of the usual base diagram or line drawing, the number of each base pin is given in the column under the symbol of the electrode. This system was developed because many of the Soviet types have base connections which do not conform to the standard base designations of the Electronic Industries Association. In those instances where an electrode is connected to more than one base pin, only the lowest numbered pin is shown in the tabulation.

Outline drawings are shown for the semiconductor diodes and transistors. Similarly photographic outlines are included for counter tubes.

#### 4. Terminology used in the Tabulation

##### 4.1 Column Headings

The headings used in the various formats are the standard symbols as defined by the Institute of Radio Engineers or descriptive words for the characteristics. They are not further defined due either to the difficulties of translation or lack of definite information.

##### 4.2 Bulb Size

This column heading, which is used in the Receiving, Power, Rectifier, etc. Groups, uses a special code to describe the bulb shape and size. The numerical part of the code indicates the diameter of the glass bulb or metal anode (power tubes) in eighths of an inch according to the American standard. The alphabetical part of the code is explained on the following page.



PREFIX

- A - Air-cooled anode
- C - Ceramic construction
- G - Globe-shaped bulb
- F - Flat top of Soviet design
- H - Helix-shaped flash tube
- M - Metal tube
- P - Spiral
- R - Ring-shaped
- S - ST design, i.e., the domed conical shaped glass bulb
- T - Cylindrical shape
- U - U-shape flash tube
- W - Water-cooled anode

POSTFIX

- B - Button glass stem
- F - Flat press glass stem

For example, a "T3F" would be a cylindrical bulb with a flat press and having a diameter of 3/8 inch.

4.3 Code

Due to the limitations of available columns in the punched card, one- to three-letter codes have been liberally developed and used in the tabulation. These have been chosen to be readily understood. The following table lists the definitions of this code for all groups in alphabetical order.

Code

A	Change of unit to amperes	AR	Argon gas-filled
ACO	Acorn tube	ARC	Arc rectifier - Mercury pool
AF	{ Audio frequency Forced air cooling	BA	Barium (metal) cathode
AHE	Argon-helium gas-filled	BAG	Beta and gamma radiation
AHN	Argon-helium-neon gas-filled	BAL	Ballast or current regulator
AKN	Argon-krypton gas-filled	BAO	Barium oxide cathode
AMK	Aluminum-Magnesium alloy with potassium surface	BEA	{ Beam pentode With beam pentode, e.g., triode beam pentode
AN	Natural air cooling	BET	Beta radiation
AO	Argon-oxygen gas-filled	BL	Blue luminescence

CODE

C	{	Circular dynode arrangement	EIM	Electromagnetic focus or deflection
		Common collector operation		
		Cold cathode		
		Continuous wave operation	ELS	Electrostatic focus or deflection
CAM		Copper-aluminum-magnesium	F	Filamentary cathode
CN		Converter	FE	Iron cathode - counter tube
COM	{	Comutator tubes	FLS	Flash tube (photographic)
		Compensation of temperature thermistors		
CON		Temperature control	G	Giga ( $10^9$ )
COU		Counter tube	GAM	Gamma radiation
CP		Cap, external in tabulation of bases	GAN	Germanium alloy, n-type
			GAP	Germanium alloy, p-type
CS		Cesium photo surface	GDP	Germanium diffused junction, p-type
CSB		Cesium antimony photo surface	GE	Germanium
CU		Copper cathode - counter tube	GEA	Germanium alloy junction
CYL		Cylindrical shape (Thermistors)	GEP	Germanium point-contact
DBA		Double anode beam pentode	GPP	Germanium point-contact, p-type
DEC		Decatron	GR	{
DET		Detector operation		
DIO	{	Diode	Graphite cathode-counter tube	
		With diode, e.g., triode diode	GS	Gas-filled
DSC		Disc shape	GSP	Germanium surface-barrier, p-type
DUO		Double, e.g., double diode with separate cathodes	GTB	Gated beam pentode
DWD	{	Duo diode (single cathode)	H	{
		With duodiode, e.g., triode duodiode		
E		Common emitter operation	HE	Helium gas-filled
EL		Electrometer tube	HG	Mercury vapor-filled



CODE

HH	Mercury-argon-hydrogen gas-filled	MOD	Modulator
HK	Hydrogen-krypton gas-filled	N	Nano ( $10^{-9}$ )
HY	Hydrogen gas-filled	NA	Neon-argon gas-filled
IC	Iconoscope	NE	Neon gas-filled
ID	Indicator tube	NEH	Neon-helium gas-filled
IF	Intermediate frequency	NI	Nickel cathode
IGN	Ignitron tube	NK	Neon-krypton gas-filled
IM	Image orthicon	NSP	Nuclear Spectrometry
J	Joules	OD	Double beam oscilloscope
K	{ Kilo ( $10^3$ ) Potassium	OS	Oscilloscope
		P	Pulse operation
KLY	Klystron	PA	Power amplifier
KX	Krypton-xenon gas-filled	PB	Purple-blue luminescence
L	Linear dynode arrangement	PEN	Pencil tube
LAM	Light	PHC	Photoconductive diode
LIT	Lighthouse	PHM	Photomultiplier
LO	Long persistence screen	PHO	Phototube
M	{ Mega ( $10^6$ ) Milli ( $10^{-3}$ )	POW	{ Pentode With pentode e.g., triode- pentode
			PTG
MAG	Magnetron	REC	Rectifier
MD	Medium persistence screen	REG	Regulator (voltage)
MEA	Temperature measurement	RD	Red luminescence
MG	Magnesium cathode	RF	Radio frequency
MX MIX	} Mixer	ROC	Rocket tube

CODE

S1-S7	Spectral sensitivity of photo surface	TV	Television tube
S	Max. dimension of cathode ray tube face	TWN	Twin with separate cathodes, e.g., twin triode
SM	Secondary emission pentode	TWT	Traveling-wave tube
SAN	Silicon alloy, n-type	U	{ Micro ( $10^{-6}$ ) U-shaped
SAP	Silicon alloy, p-type	UF	Ultra high frequency
SCC	Scintillation Counters	V	Venetian-blind dynode arrangement
SDN	Silicon diffused junction, n-type	VC	Vacuum
SH	Short persistence screen	VB	Violet-blue luminescence
SI	Silicon	VI	Vidicon
SIA	Silicon alloy junction	VID	Video detector
SIN	Single e.g., single triode	W	{ Change of units to watts Tungsten cathode Water-cooled
SIP	Silicon, point contact	WG	Wave guide coupling
SM	Secondary emission pentode	WH	White luminescence
SN	Tin cathode-counter tube	X	Smallest dimension-rectangular photocathode
SQ	Self-quenching type of counter tube	XE	Xenon gas-filled
T	Thoriated tungsten cathode	YO	Yellow-orange luminescence
TET	Tetrode	3C	Three color screen for television
THM	Thermocouple tube	*}	The meaning of these symbols indicated in the column heading
THY	Thyratron	#}	
TMS	Thermistor	□	Less than (before digits)
TRD	With triple diode	@	Obsolete type
TRI	{ Triode With triode e.g., pentode-triode		

GROUP I, NUMERICAL					COST SPEC. NO.
TYPE NUMBER	KIND	TYPE	TABLE NO.	SIMILAR TYPES	
.24B12-1B	BAL	SIN	VI		
.3B17-35	BAL	SIN	VI		
.3B65-135	BAL	SIN	VI		
.425B95-12	BAL	SIN	VI		
.62H6B	PND	SIN	II		
.6P2B	PND	SIN	II	CK505AX	
.85B55-12	BAL	SIN	VI		
FS-AG	PHC	XV			
FS-AO	PHC	XV			
FS-AV	PHC	XV			
FS-D0	PHC	XV			
FS-KG	PHC	XV			
FS-K0	PHC	XV			
FS-KV	PHC	XV			
GR-0.8/1.6	DWO	SIN		GR1-0.25/1.5□	
TG-0.3/0.3	TRI	THY		TG1-0.1/0.3□, BB4*	
TG-0.5/1.3	TET	THY		TG1-0.1/1.3□, 2050*	
TGI-0.1/0.3	TRI	THY	VII		
VG0251500	OID	SIN		GR1-0.25/1.0□	
01A	REC	XI			
D1B	REC	XI			
D1D	REC	XI			
D1G	REC	XI			
D1V	REC	XI			
D1YE	REC	XI			
D1ZH	REC	XI			
DG-S1	MIX	XIII			
DG-TS1	REC	XI		02G□	
DK-11	MIX	XIII			
OK-S1	MIX	XIII			
DK-V1	DET	XIII			
DL-S1	MIX	XIII			
FEU-1	PHM	XV			
FEU-1B	PHM	XVI			
FEU-1B1V	PHM	XVI			
FEU-1B2V	PHM	XVI			
FEU-1V	PHM	XVI			
FEU-1S	PHM	XVI			
FS-A1	PHC	XV			
FS-D1	PHC	XV			
FS-K1	PHC	XV			
GE-1	TET	SIN	III	GKE-100*	
GG-1 0.3/8	DID	SIN	IV		
GG1-0.5/5	DID	SIN	IV	VG1.5/5000□	
GG-1-0.5/20	DID	SIN	IV		
GG-1-1/22	DIO	SIN	IV		
GG-1-2/5	DIO	SIN	IV		
GG-1-2/16	DID	SIN	IV		
GG-1.5/15	DID	SIN		GG1-0.5/5□	
GK1A	TRI	SIN	III		
GM1A	TRI	SIN	III		
GMI-1B	TRI	SIN	III		
GR1-02/15	DID	SIN	IV		
GR-1-0.3/8.5	DIO	SIN	IV		
GR-1-25/15	DWO	SIN	IV		
GS-1B	TRI	SIN	III		
GUZH-1	PND	SIN		G411□	
I-1-70/0.8	TRI	THY	VII		
I-1-100/1.5	TRI	THY	VII		
I-1-140/0.8	TRI	THY	VII		
KF-1	TET	TWN		GU-29□, 829B*	
KMT-1	TMS	XIX			
KZH1	PHC	SIN		G411□	
LD1	PHC	SIN		12S35□	
LG-1	DWO	SIN		12KH35□	
LI-1	IC	VIII			
MMT-1	TMS	XIX			
M51	TRI	SIN		GM-60□	
DG-1	OEC	XXIII			
P1A		X			
P1B		X			
P1D		X			

GROUP I, NUMERICAL					COST SPEC. NO.
TYPE NUMBER	KIND	TYPE	TABLE NO.	SIMILAR TYPES	
P1G			X		
P1I			X		
P1V			X		
P1YE			X		
P1ZH			X		
RB-1			XXII		
S1A			X		
S1B			X		
S1D			X		
S1G			X		
S1V			X		
S1YE			X		
S61B	OIO	SIN		DA2*	
S61P	DID	SIN	V	OA2*	
S61P-V	REG		V		
S61P-YE	REG		V		
SI-1B6	CDU		XXI		
SI-1G	CDU		XXI		
T-1B	TRI	THY		TG-1B□	
T61B	TRI	THY	VII		
T61B-V	TRI	THY	VII		
TG1-00/05	TET	THY	VII		
TG1-01/03	TRI	THY	VII	884*	
TG1-01/13	TET	THY	VII	2050*	7B43-55
TG1-05/12	TRI	THY	VII		
TG1-1.0/0	TET	THY	VII		
TG1-1.5/2	TRI	THY	VII		
TG1-1.6/1	TRI	THY	VII		
TG1-2.5/3	TRI	THY	VII	TG1-2.5/4□	
TG1-2.5/4	TRI	THY	VII	TG8/3, TG1-2.5/3□	7952-56
TG1-2.5/10	TRI	THY	VII		
TG1-3.2/1	TRI	THY	VII		
TG1-6.4/1	TRI	THY	VII		
TG1-5/3	TRI	THY	VII		
TG1-12.5/1.3	TRI	THY	VII		
TG1-25/10	TRI	THY	VII		
TG1-125/1	TRI	THY	VII		
TGI-0.1/0.3	TRI	THY	VII		
TGI-1B	TRI	THY	VII		
TGI-1-3/1	TET	THY	VII		
TGI-1-10/1		THY	VII		
TGI-1-35/3	TRI	THY	VII		
TGI-1-50/5	TRI	THY	VII		
TGI-1-90/8	TRI	THY	VII	MTI-4□	
TGI-1-130/8	TRI	THY	VII		
TGI-1-130/10	TRI	THY	VII		
TGI-1-325/16	TRI	THY	VII	MTI-5□, TGI-325/16□	
TGI-1-400/3	TRI	THY	VII		
TGI-1-400/16	TRI	THY	VII		
TGI-1-700/25	TRI	THY	VII		
TKH1	TRI	THY	VII		
TM-1	TRI	SIN		6S50□, 2C40*	
TD-1	PNO	SIN		10ZH12S□	
TR1-5/2	TRI	THY	VII	VT-3	7954-56
TR1-6/15	TRI	THY	VII		7955-56
TR1-15/15	TRI	THY	VII		
TR1-40/15	TRI	THY	VII		
TR1-85/15	TRI	THY	VII		7956-56
TR1-130/15	TRI	THY	VII		
TSG-1	PHD	XV			
TSV-1	PHD	XV			
TVB-1	THM	XXVIII			
V1-00313	DID	SIN	IV	V13/30□	
V1-02/20	DIO	SIN	IV		
V1-03/13	DID	SIN	IV		
V1-05/70	DID	SIN	IV		
V1-06/30	DID	SIN	IV		
V1-1/2.5	DID	SIN	IV		
V1-1/30	DIO	SIN	IV		
V1-1/40	OID	SIN	IV		
V1-2/40	DID	SIN	IV		
V1-3/16	DID	SIN	IV		

GROUP I, NUMERICAL

TYPE NUMBER	KIND	TYPE	TABLE NO.	SIMILAR TYPES	COST SPEC. NO.
VI-3/70	DID	SIN	IV		
VI-4/40	DID	SIN	IV		
VI-15/55	DIO	SIN	IV		
VD1	DID	SIN		VI-1/40□	
VD1-1D	DIO	SIN		VI-1-10D/50□	
VG1/B500	OID	SIN	IV		
VG1.5/500D	DID	SIN	IV	GG2-D.5/5□	
VI-1-5/20	DID	SIN	IV		
VI-1-5/30	DID	SIN	IV		
VI-1-18/32	DIO	SIN	IV		
VI-1-27/35	DID	SIN	IV		
VI-1-3D/25	DID	SIN	IV		
VI-1-70/32	DID	SIN	IV		
VI-1-100/50	OID	SIN	IV		
VO-1	OID	SIN	IV		
VSTS-1 F-3	PHD		XV		
VT-1	TRI	THY		TG-2.5/5□	
1A1P	PTG	SIN	II	1R5*, DK91#	
1A2P	PTG	SIN	II	DK96#, 1R5*	
1B1P	PND	DID	II	1S5*, DAF91#	8006-56
1B2P	PNO	DID	II	DAF96#, 1S5*	
1B5-9	BAL	SIN	VI		
1B1D-17	BAL	SIN	VI		
1E1P	TET	SIN	II		
1E3P	*TRI	SIN	II	EM-4□	
1I2P	PND	TRI	II		
1K1P	PND	SIN	II	1T4*, DF91#	7707-55
1K2P	PND	SIN	II	DF96#, 1T4*	
1N1	*TRI	TWN		1N35#	
1N3S	TRI	TWN	II	1N1□, 1G6-GT*	
1P2B	PND	SIN	II	CK5D7AX	
1P3B	PND	SIN	II		
1P4B	PND	SIN	II		
1P24B	PND	SIN	II		
1S12P	TRI	SIN	II	DC96#	
1T51	*OID	SIN		1T51□, 1VD1□	
1T51S	DID	SIN	II	1T51□, 1V01□	
1T57S	DID	SIN	II	DY3D#, 1B3/8D16*	8359-57
1T511P	DIO	SIN	II		
1V3/8D16	*DIO	SIN		1T57S□, 1B3/8D16*	
1VD1	*OID	SIN		1T51, 1T51S□	
1VD2	*DID	SIN		1T57S□, 1B3/8D16*	
1ZM2	*PND	SIN		1ZM2□	
1ZM2M	PND	SIN	II	1ZM2*	
1ZM17B	PND	SIN	II		
1ZM18B	PND	SIN	II		
1ZM24B	PND	SIN	II		
1ZM29B	PND	SIN	II		
D2A	*REC	XI		DG-TS9□	
D2B	*REC	XI		DG-TS10□	
O2D	*REC	XI		OG-TS2□	
D2G	*REC	XI		DG-TS1□	
D2I	REC	XI			
D2K	REC	XI		DG-TS6□	
D2M	REC	XI		DG-TS7□	
D2N	REC	XI		DG-TS15□	
D2P	REC	XI		DG-TS16□	
D2R	REC	XI			
D2V	*REC	XI		DG-TS8□	
O2YE	*REC	XI		DG-TS4□	
D2ZH	*REC	XI		DG-TS5□	
DG-S2	MIX	XIII			
DG-TS2	REC	XI		D2D□	
DI-2-1D	*DID	SIN		2D1S□	
DK-12	MIX	XIII			
OK-S2	MIX	XIII			
DK-V2	DET	XIII			
OL-S2	MIX	XIII			
DSh2-1D	*DIO	SIN		2D2S□	
FEU-2	PHM	XV			
FEU-2B	PHM	XVI			
FEU-2B1V	PHM	XVI			

GROUP I, NUMERICAL

TYPE NUMBER	KIND	TYPE	TABLE NO.	SIMILAR TYPES	COST SPEC. NO.
FEU-2M	PHM		XVI		
FEU-2V	PHM		XVI		
FS-B2	PHC		XV		
FS-K2	PHC		XV		
FS-2A	PHC		XV		
GE-2	TET	SIN	III	GKE-150#	
GMI-2B	TET	SIN	III		
GS-2B	TRI	SIN	III		
GUZH-2	BEA	SIN		G8D7□, 8D7*	
GZH2	*PND	SIN		G41□	
I-2-5D/1.5	TRI	THY	VII		
KF-2	BEA	TWN		GU-32□, 832-A*	
KS-2	TRI	SIN		GU-4□	
KZH-2	BEA	SIN		G-8D7□, 8D7*	
MTI-2	TRI	THY	VII	TGI-20D□	
DG-2	OEC		XXIII		
P2A			X		
P2B			X		
PT-2	TRI	THY		TG-213*	
R-2			XXII		
RB-2			XXII		
S2A			X		
S2B			X		
S2G			X		
S2V			X		
SG2P	DIO	SIN	V	DB2*	
SG2S	DID	SIN	V	OA3*	
S1-2B	COU		XXI		
S1-2BG	COU		XXI		
ST2S	BAL	TWN	VI		
STS-2	COU		XXI		
STSV-2A F-2	PHD		XV		
TG2-D1/01	TRI	THY	VII		
TG2-0.5/12	TRI	THY	VII		
TG-2.5/5	TRI	THY	VII	VT-1	
TGI-2-26D/12	TRI	THY	VII		
TGI-2-32S16	TRI	THY	VII		
TGI-2-4DD35	TRI	THY	VII		
TKH-2	TRI	THY	VII		
TD-2	PND	SIN		10P12S□	
TV-2	THM		XVIII		
TVB-2	THM		XVIII		
VD2	DID	SIN		V1-2/40□	
VI-2-27/35	DID	SIN	IV		
VI-2-7D/32	DIO	SIN	IV		
VI-2-100/50	DID	SIN	IV		
2A1	PTG	SIN	II	SD242□, 2A1M	
2A1M	*PTG	SIN		2A1□	
2A3	TRI	SIN		2S4S□, 2A3*	
2D1L	DWD	SIN	II		
2D1S	DID	SIN	II	01-2-10□	
2D2S	DID	SIN	II	D5H2-10□	
2D3B	DIO	SIN	II		
2D3S	DID	SIN	II		
2D7S	DID	SIN	II		
2D9S	DID	SIN	II		
2D21	TET	THY		TG3-0.1/1.3□, 2D21*	
2E1	*TET	SIN	II		
2E2	*TET	SIN	II	U8155□	
2E2P	TET	TWN	II		
2J55	MAG		IX		
2K1	*PND		II	2K1M□	
2K1M	*PND	SIN	II	2K1□, 5B241□, SD241□	
2K2	PND	SIN		2K2M□	
2K2M	*PND	SIN	II	2K2*	
2KH1	*DWO	SIN		2KH1□	
2KH1L	DWO	SIN	II	2KH1*	
2KH2	*DIO	SIN		2VDB□, 2TS2S□, 2X2*	
2N1	TRI	DUO	II	SB243, S0243, 2N1M□	
2N1M	*TRI	DUD		2N1□, SB243□, S0243□	
2P1	BEA	SIN	II	SB244□, SD244□	
2P1M	*BEA	SIN		2P1P□	



GROUP I, NUMERICAL					
TYPE NUMBER	KIND	TYPE	TABLE NO.	SIMILAR TYPES	COST SPEC. NO.
2P1P	BEA	SIN	II	DL94#, 2P1M	8005 56
2P9M	@BEA	SIN	II	2P9a, 2P9S	
2P2	@BEA	SIN	II		
2P2P	8EA	SIN	II	DL96#, 3S4*	
2P3	BEA	SIN	II	S8258a, S0258a, 2P2Ma	
2P9	@BEA	SIN		2P9Ma, 2P9S	
2P9S	BEA	SIN		2P9Ma, 2P9	
2P19B	PND	SIN	II		
2P21S	BEA	SIN	II		
2P29	@PND	SIN		2P29La	
2P29L	PND	SIN	II	2P29La	
2P29P	PND	SIN	II		
2S1	TRI	SIN	II		
2S2	TRI	SIN	II	UB240a	
2S3	@TRI	SIN		2S45a, 2A3*	
2S3M	@TRI	SIN		2S2a	8527-57
2S4S	TRI	SIN	II	2A3*	
2S14B	TRI	SIN	II		
2S22	TRI	SIN		6S85a, 2C22*	
2TM-20	TRI	SIN	III		
2TM-100	TRI	TWN	III		
2TS2S	DID	SIN	II	2X2*	
2V6	DID	ARC	IV		
2V12	DID	ARC	IV		
2V20	DIO	ARC	IV		
2VD8	DID	SIN	II		
2VN12	DID	ARC	IV		
2VN20	DIO	ARC	IV		
22H1M	@PND	SIN	II	SB245a	
22H2M	PND	SIN	II		
22H4	@PND	SIN	II	S0257a	
22H14B	PND	SIN	II		
22H15B	PND	SIN	II		
22H27	@PND	SIN		22H27La	
22H27L	PND	SIN	II	22H27a	
22H27P	PND	SIN	II		
22H28L	PND	SIN	II		
D3A	DET		XIII		
D38	DET		XIII		
DG-53	MIX		XIII		
DG-T53	REC		XI		
DK-53	MIX		XIII		
DK-V3	DET		XIII		
DL-53	MIX		XIII		
FEU-3B	PHM		XVI		
FEU-3M	PHM		XVI		
FEU-R3	PHM		XVI		
FS-3A	PHC		XV		
FS-K3	PHC		XV		
GI-3	TRI	SIN	III	2C26A*	
GI-3/100	TRI	SIN		GI-3a	
GK3A	TRI	SIN	III		
GMI-3	TET	SIN	III		
GS-3B	TET	SIN	III		
GUZH-3	BEA	SIN		G1625a, 1625*	
KF-3	BEA	SIN		GU-13a, 813*	
K2H-3	BEA	SIN		G-1625a, 1625*	
LI-3	IC		VIII		
LIM-3	LAM		XXIII		
MS3	@TRI	SIN		GM5/a, UB180#, M45/a	
DG-3	DEC		XXIII		
P3A			X		
P3B			X		
P3V			X		
PIM-3	IC		VIII		
PT-3	TRI	THY	VII	TG-235a	
R-3			XXII		
RB-3			XXII		
S3A			X		
S3B			X		
S3D			X		
S3G			X		

GROUP I, NUMERICAL					
TYPE NUMBER	KIND	TYPE	TABLE NO.	SIMILAR TYPES	COST SPEC. NO.
S3V			X		OC3*
S3YE			X		
SG3P	REG		V		
SG3S	DID	SIN	V		
SI-3B	COU		XXI		
ST3P	DID	SIN	VI		2D21*
STS-3	CDU		XXI		
STSV-3	PHD		XV		
TG3-01/13	TET	THY	VII		
TG3-2*5/10	TRI	THY	VII		
TKH3B	TET	THY	VII		
TD-3	PND	SIN		72H125a	
TSG-3	PHD		XV		
TSV-3	PHO		XV		
TV8-3	THM		XVIII		
VDI-3D	DID	SIN		VI-1-30/25a	VI-1-30/25a TR1-5/2a
VT-3	TRI	THY		TR1-5/2a	
3A4S	PND	SIN	II		
3B4S	8EA	SIN	II		
3E29	@BEA	TWN		GI-30a, 3E29*	
3J21	MAG		IX		
3LD1-I			VIII		
3S1	TRI	SIN	II	TD-141a	
3S2	TRI	SIN	II	TD-142a	
3S9	@TRI	SIN	II		
3TS16S	DIO		II		8LD29a, 3BP1A*
3TS18P	@DID	SIN			
3V30	DIO	ARC	IV		
3VN30	DID	ARC	IV		
3VN60	DID	ARC	IV		
3VN100	DID	ARC	IV		
3VP1	@OS				
DG-54	MIX		XIII		
DG-T54	REC		XI	D2YEa	
DK-54	MIX		XIII		
DK-V4	DET		XIII		1E3Pa
DL-54	MIX		XIII		
EM-4	TRI	SIN			
FS-A4	PHC		XV		
FS-K4	PHC		XV		
GI-4A	TRI	SIN	III		
GKV-4	TRI	SIN		GU-4a	
GMI-48	TET	SIN	III		
GS-4	TRI	SIN	III		
GS-4	CDU		XXI		
GS-4B	TRI	SIN		G431Aa	6U-150a
GS4D	TRI	SIN	III		
GU4	TRI	SIN	III		
GU4A	TRI	SIN	III		
KMT-4	TMS		XIX		
KS-4	TRI	SIN		GU-150a	
LIM-4	LAM		XXIII		
LP-4	COM	ACD	VII		
MMT-4	TMS		XIX		
MS-4	COU		XXI		
MSTR-4	CDU		XXI		TG1-1-90/8a
MTI-4	TRI	THY	VII		
DG-5	DEC		XXIII		
P4			X	2N68*	
P4A			X		
P4B			X		
P4D			X		
P4G			X		
P4L			X		
P4V			X		
PIM-4	IC		VIII		DD3*
R-4			XXII		
S4A			X		
S4B			X		
S4G			X		
S4V			X		
SG4S	DIO	SIN	V	DD3*	



GROUP I, NUMERICAL

TYPE NUMBER	KIND	TYPE	TABLE NO.	SIMILAR TYPES	COST SPEC. NO.
SI-4G	CDU		XXI		
STSV-4	PHD		XV		
TGI-4	TRI THY			TGI-1-130/10a	
TKH-4B	TET THY	VII			
TO-4	PND SIN			7P125a	
TSG-4	PHD		XV		
TSV-4	PHD		XV		
TV-4	THM		XVIII		
TVB-4	THM		XVIII		
VDI-4D	DID SIN			VI-1-70/32a	
VS-4	CDU		XXI		
4D2	*DID SIN			4TS65a	
4D9S	*DIO SIN II				
4E1	*TET SIN II				
4E2	*TET SIN II				
4E3	*TET SIN II				
4F6S	BEA SIN II				
4J26-30	MAG	IX			
4J45	MAG	IX			
4J90	MAG	IX			
4N1	TRI DUD II			5B259a, 5D259a	
4P1	*PND SIN II				
4P1L	PND SIN II				
4P10S	PND SIN II				
4S1	TRI SIN II			UB107a	
4S2	TRI SIN II			UB110a	
4S3	*TRI SIN II				
4S3S	TRI SIN II				
4S4	*TRI SIN II				
4S5	TRI SIN II			5D-185a	
4TS1M	*DID SIN			4TS65a	
4TS6S	DID SIN II				
4TS14S	DIO SIN II				
4VD1	DID SIN II				
4VKH1	*DIO TWN II			V0-188a	
4VKH2	*DIO SIN II			V0-188a	
4ZH1L	PND SIN II				
4ZH1P	PND SIN II				
4ZH5	*TET SIN II			4ZH55a	
4ZH5S	PND SIN II				
DG-TS5	REC	XI		D22H#a	
DK-V5	DET	XIII			
FEU-R5	PHM	XVI			
FS-K5	PHC	XV			
G-5	TRI SIN			M39a	
G-5A	TRI SIN			GU5Aa	
G-5RA	TRI SIN			GU-58a	
GI-5B	TRI SIN III				
GK5A	TRI SIN III				
GMI-5	TET SIN III				
GS-5B	TRI SIN			G433a	
GU5A	TRI SIN III				
GU5B	TRI SIN III				
GUD-5	TRI SIN			G120a	
LP-5	CDM ACO VII				
MTI-5	*TRI THY			TGI-1-32516a	
DG-5	DEC	XXIII			
P5A	X				
P5B	X			2N107*	
P5D	X			CK727*	
P5G	X			2N65*	
P5V	X				
P5YE	X				
R-5	XXII				
RB-5	XXII				
RB-5A	XXII				
SG5B	DID SIN V				
SG5B-V	REG V				
STS-5	CDU	XXI			
TKH-5A	TRI THY VII				
TV-5	THM	XVIII			
TVB-5	THM	XVIII			

GROUP I, NUMERICAL

TYPE NUMBER	KIND	TYPE	TABLE NO.	SIMILAR TYPES	COST SPEC. NO.
UV-5	TWT		IX		
VG-5	PDW		XII		
5LD1B	*DS			5LD38a, 2AP1*	
5LD38I	DS		VIII	2AP1*	
5SR1	*DS			5CP1A*	
5SR7	*DS			5CP7A*	
5TS3S	DWD SIN II			5U4G*	8360-57
5TS4	DID DUD			5TS45a, 5Z4G*	
5TS4M	DID DUD II				
5TS4S	DID DUD II			5Z4*	8079-56
5TS8S	DWD SIN II				8361-57
5TS9SE	DWD SIN II				
5TS9S	DWD SIN II			1502a	8362-57
5TS12P	DID SIN II				
5VKH1	*DWD SIN			5Z4G*	
5VKH2	*DWD SIN II			5U4G*	
5VKH3	*DWD SIN II			5Y3G*	
D6	REG	XII			
DG-TS6	REC	XI		D2Ka	
DK-V6	DET	XIII			
FS-A6	PHC	XV			
FS-D6	PHC	XV			
FS-K6	PHC	XV			
GI-6B	TRI SIN III				
GK6A	TRI SIN III				
GMI-6	BEA TWN III				
GS6	TRI SIN III				
GS-6	CDU	XXI			
LD-6	TRI SIN			GI-68a	
LI-6	IC	VIII			
MMT-6	TMS	XIX			
MS-6	CDU	XXI			
P6A	X				
P6B	X				
P6D	X				
P6G	X				
P6V	X				
R6	XXII				
STS-6	CDU	XXI			
STSV-6	F-4 PHD	XV			
TSV-6	F-5 PHD	XV			
TVB-6	THM	XVIII			
UV-6	TWT	IX			
VS-6	CDU	XXI			
6A2P	PTG SIN II			68E6*, 6K90#	8354 5/1
6A3P	*GTB SIN II			68M6*	
6A5B	*PTG SIN			6L7*	
6A6A	*DID				
6A7	PTG SIN II			65A7*	8086-56
6A8	PTG SIN II			6A8B, 6A8*	8367-57
6A8B	*PTG SIN			6A8*	
6A8M	*PTG SIN			6A8S#a	
6A10S	PTG SIN II			65A7*	8087-56
6A15B	*PTG SIN			65A7*	
6AG7	*BEA SIN			6P9a, 6AG7*	
6AZH5	*PND SIN			6AG5*, EF 96#	
6B1P	PND DID II				
6B2P	PND DID II			L100#a	
6B4	*TRI SIN			6A3*	
6B8	*PND DWD			6B8*, 6B8G*, 6B8M#	
6B8M	*PND DWD			6B8S, 6B8G*	
6B8S	PND DWD II			6B8G*, 6B8M#	8369-57
6BKH1	*DID DUD			6KH55a	
6D1A	*DID SIN			6D6A*, 5704*	
6D12H	*DID SIN			6D42H, 9004*	
6D3D	DID SIN II			559*	
6D42H	DID SIN II			9004*	
6D6A	DID SIN II			5704*, *6D1Aa	
6D8D	DID SIN II				
6D10D	DID	II			
6D14P	DID SIN II				
6E5P	TET SIN II				

GROUP I, NUMERICAL					
TYPE NUMBER	KIND	TYPE	TABLE NO.	SIMILAR TYPES	COST SPEC. NO.
6F1P	PNO	TRI	II	EF80#, 6U8*	
6F5	TRI	SIN		6S4B□, 6F5*	
6F5B	TRI	SIN		6S4B□, 6F5*	
6F5M	TRI	II		6F5GT*, 6S4□	8372-57
6F6	PNO	SIN		6P6B□, 6F6*	
6F6S	PNO	SIN	II	6F6-GT*	8082-56
6F7	PND	TRI	II		
6G1	TRI	OWD	II	6SR7*	
6G2	TRI	DWD	II	6S07*	8370-57
6G2P-K	TRI	DWO	II		
6G2S	TRI	DWO	II	6S07G*	
6G3P	TRI	TRO	II	6TB*	
6G3S	TRI	DWO	II		
6G7	TRI	DWD	II	6Q7#	8371-57
6I1P	PTG	TRI	II	ECH81#, 6AJ8*	
6K1B	PND	SIN	II	5702*	
6K1L	PND	SIN	II		
6K1P	PND	SIN	II	9DD3*	
6K1ZH	PNO	SIN	II	956*	
6K2P	PND	SIN	II	6K4P□	
6K3	PND	SIN	II	6SK7*	8084-56
6K4	PND	SIN	II	6SG7*	8083-56
6K4P	PNO	SIN	II	EF93#, 6BA6*	8352-57
6K7	PND	SIN	II	6K7S□, 6K7G*, 6K9S□	8363-57
6K7S	PND	SIN	II	6K9S□, 6K7G*, 6K7	
6K9S	PND	SIN	II	6K7G*, 6SK7*	
6K19P	PNO	SIN	II	6K1P□, 9D03*	
6KH1ZH	OIO	SIN		6D4ZH□, 9004*	
6KH2P	DID	TWN	II	EAA91#, 6AL5*	8348-57
6KH4P	DWO	SIN		6TS4P□	
6KH5	DWD	SIN		6VKH1□, 6X5GT*	
6KH5S	DWO	SIN		6VKH1□, 6X5GT*	
6KH6	DID	TWN		6KH6B□, 6H6*	
6KH6B	DIO	TWN	II	6H6-G*	
6KH6M	DID	TWN		6KH6S□, 6H6G*	
6KH6S	OIO	TWN	II	6H6-G*	8080-56
6KH7B	DIO	TWN	II		
6L7	PTG	SIN	II	6L7*	
6LK1B	TV	VIII			
6N1P	TRI	TWN	II	6BK7*	8355-57
6N2P	TRI	TWN	II	ECC83#, 6AX7*	8356-57
6N3P	TRI	TWN	II	ECH42#, 2C51*	8357-57
6N4P	TRI	TWN	II	12AY7*	
6N5P	TRI	TWN	II		
6N5S	TRI	TWN	II	6AS7G*	
6N6	DIO	TWN		6KH6B□, 6H6*	
6N6P	TRI	TWN	II		
6N7	TRI	TWN	II	6N7*, 6N7S□	
6N7S	TRI	TWN	II	6N7-GT*	8374-57
6N8	TRI	TWN		6N8S□, 6SN7GT*	
6N8M	TRI	TWN		6N8S□, 6SN7GT*	
6N8S	TRI	TWN	II	6SN7-GT*	
6N9	TRI	TWN		6N9S□, 6SL7GT*	
6N9M	TRI	TWN		6N9S□, 6SL7GT*	
6N9S	TRI	TWN	II	6SL7GT*	
6N10	TRI	TWN		6N10S□, 6SC7GT*	
6N10M	TRI	TWN		6N10S□, 6SC7GT*	
6N10S	TRI	TWN	II	6SC7GT*	
6N11	TRI	TWN		6N5S□, 6AS7G*	
6N12S	TRI	TWN	II	6DN7*	
6N13S	TRI	TWN	II	6080*	8378-57
6N14P	TRI	TWN	II	ECC84#, 6BX8*	
6N15	TRI	TWN	II	6J6*, 6N15P□	
6N15P	TRI	TWN	II	6J6*, ECC91#	
6N16B	TRI	TWN	II		
6N17B	TRI	TWN	II		
6N23P	TRI	TWN	II		
6P1P	BEA	SIN	II	EL90#, 6A05*	8358-57
6P2	BEA	SIN		6P6S□, 6V6GT*	
6P2P	PNO	SIN	II		
6P3	BEA	SIN		6P3S□, 6L6G*	
6P3B	BEA	SIN		6P3S□, 6L6G*	

GROUP I, NUMERICAL					
TYPE NUMBER	KIND	TYPE	TABLE NO.	SIMILAR TYPES	COST SPEC. NO.
6P3S	BEA	SIN	II	6L6G*	8376-57
6P4	PNO	SIN	II	6G6G*	
6P6	BEA	SIN		6P6S□, 6V6GT*	
6P6B	PND	SIN	II	6F6*	
6P6P	PBEA	SIN	II		
6P6S	BEA	SIN	II	6V6-GT*	8375-57
6P7	PBEA	SIN		6P7S□, 6BG6GA*	
6P7S	BEA	SIN	II	6P7□, 6BG6GA*	
6P8P	TRI	SIN		6S1P□, 9002*	
6P8S	PND	SIN	II	6G6G*	
6P9	BEA	SIN	II	6AG7*	8371-57
6P9E	BEA	SIN	II		
6P13S	BEA	SIN	II		
6P14P	BEA	SIN	II	EL84#, 6B05*	
6P15P	BEA	SIN	II		
6P17S	BEA	SIN	II		
6P18P	BEA	SIN	II	EL82#	
6P20S	PBEA	SIN	II		
6P21S	PBEA	SIN	II		
6P31S	BEA	SIN	II		
6R1B	TRI	DWD		6G1□, 6SR7*	
6R7	TRI	OWD		6G7□, 607*	
6R7B	TRI	DWD		6G7□, 607*	
6R17B	TRI	DWD		6G2□, 6S07*	
6S1B	TRI	SIN		6S6B□, 5703*	
6S1P	TRI	SIN	II	9D02*	
6S1ZH	TRI	SIN	II	4671*, 955*	
6S2	TRI	SIN		6J5-GT*	
6S2B	TRI	SIN	II	6S7B□, 5744*	
6S2P	TRI	SIN	II	6J4*	8353-57
6S2S	TRI	SIN	II	6J5-GT*	8081-56
6S3B	TRI	SIN	II	6K4A*	
6S3P	TRI	SIN	II		
6S4	TRI	SIN		6F5	
6S4B	TRI	SIN	II	6F5*	
6S4P	TRI	SIN	II		
6S4S	TRI	SIN	II	6B4-G*	8373-57
6S5	TRI	SIN	II	6S5S□, 6C5GT*	
6S5B	TRI	SIN		6C5-GT*	
6S50	TRI	SIN	II	TM1□, 2C4D*	
6S5S	TRI	SIN	II	6C5-GT*	8368-57
6S6B	TRI	SIN	II	57D3*	
6S7B	TRI	SIN	II	5744*	
6S8P	TRI	SIN		6S1P□, 9002*	
6S8S	TRI	SIN	II	2C22*	
6S9D	TRI	SIN	II		
6S10D	TRI	SIN	II		
6S110	TRI	SIN	II		
6S13D	TRI	SIN	II		
6S15P	TRI	SIN	II		
6S160	TRI	SIN	II		
6S17K	TRI	SIN	II		
6S18S	TRI	SIN	II		
6S19P	TRI	SIN	II		
6S20S	TRI	SIN	II		
6S210	TRI	SIN	II		
6SK7	PNO	TRI	II		
6TS4P	DWO	SIN	II	6X4*	
6TS4S	DIO	SIN	II		8347-57
6TS5S	DWO	SIN	II	6X5GT*	8528-57
6TS10P	DID	SIN	II	6B3*	
6TS13P	DID	SIN	II		
6TS15S	DID	TWN	II		
6TS17S	DIO	SIN	II		
6VIP	PNO	SIN	II		
6VKH1	OWO	SIN	II		
6YE1P	TRI	SIN	II	FM80#, 6BR5*	
6YE5	TRI	SIN	II	6YE5□	
6YE5S	TRI	SIN	II	6YE5□	8379-57
6ZH1B	PND	SIN	II	5702*	
6ZH1L	PND	SIN	II		
6ZH1P	PNO	SIN	II	6AK5*, EF94#	8349-57

GROUP I, NUMERICAL

TYPE NUMBER	KIND	TYPE	TABLE NO.	SIMILAR TYPES	COST SPEC. NO.
62H12H	PND	SIN	17	95A*	
62H2B	PND	SIN	II	978A*, 5630*	
62H2M	PND	SIN	II	1851*	
62H2P	PND	SIN	II	6A96*	
62H3	PND	SIN	II	65H7*	8085-56
62H3M	PND	SIN	II	6AB7/1853*	
62H3P	PND	SIN	II	6AG5*, EF96#	8350-57
62H4	PND	SIN	II	6AC7*	8364-57
62H4B	PND	SIN	II	6AG7*	
62H4E	PND	SIN	II		
62H4P	PND	SIN	II	6AU6*, EF94#	
62H5	PND	SIN	II	6J5*	
62H5A	PND	SIN	II		
62H5B	PND	SIN	II		
62H5P	BEA	SIN	II	6AH6*	8351-57
62H6M	PND	SIN	II	6J7*	
62H6S	PND	SIN	II	262#	
62H7	PND	SIN	II	6J7	8365-57
62H7B	PND	SIN	II	6W7G*	
62H8	PND	SIN	II	6SJ7*	8366-57
62H8S	PND	SIN	II		
62H9B	PND	SIN	II		
62H9P	PND	SIN	II		
62H10B	PND	SIN	II		
62H10P	PND	SIN	II		
62H11B	PND	SIN	II	6SH7*	
62H11P	PND	SIN	II	6805*	
62H12B	PND	SIN	II	65G7*	
62H13	PND	SIN	II	6ZH13L□	
62H13L	PND	SIN	II	6ZH13	
62H2DP	BEA	DIO	II		
62H21P	BEA	DIO	II		
62H22P	DIO	BEA	II		
62H23P	PND	DBA	II		
62H32P	PND	SIN	II		
D7	REG		XII		
D7A	REC		XI	DG-TS21□	
D7B	REC		XI	DG-TS22□	
D7D	REC		XI	DG-TS25□	
D7G	REC		XI	OG-TS24□	
D7V	REC		XI	DG-TS23□	
D7YE	REC		XI		
D7ZH	REC		XI	OG-TS27□	
DG-TS7	REC		XI	D2M□	
DK-S7	MIX		XIII		
DK-V7	DET		XIII		
FS-K7	PHC		XV		
GI-7B	TRI	SIN	III		
GMI-7	TET	SIN	III		
GS-7	COU		XXI		
GS-7	TRI	SIN		GK-300D□	
GS-7A	TRI	SIN	III		
GS-7B	TRI	SIN	III		
KS-7	TRI	SIN		G-811□, 811-A*	
LD-7	TRI	SIN		GI-7B□	
LI-7	IC		VIII		
MS-7	COU		XXI		
P7			X		
R-7			XXII		
SG7S	DIO	SIN	V		
TVB-7	THM		XVIII		
UV-7	TWT		IX		
7L01M	OS		VIII		
7L0551	OS		VIII	3MP1*	
7P125	PND	SIN	II		
7ZH12S	PND	SIN	II	328A*	
OB	REG		XII		
DG-TS8	REC		XI	D2V□	
FS-K8	PHC		XV		
GI-8	PND	SIN	III	PI-3D00*	
GS-8	COU		XXI		
GUB	TRI	SIN	III		7711-55

GROUP I, NUMERICAL

TYPE NUMBER	KIND	TYPE	TABLE NO.	SIMILAR TYPES	COST SPEC. NO.
KMT-8	TMS		XIX		
MMT-8	TMS		XIX		
MS-8	COU		XXI		
P8			X		
P8A			X		
R-8			XXII		
SG8S	DIO	SIN	V		
STS-8	COU		XXI		
T8D	TMS		XIX		
T8E	TMS		XIX		
T8M	TMS		XIX		
T8R	TMS		XIX		
T8S1	TMS		XIX		
T8S1M	TMS		XIX		
T8S2	TMS		XIX		
T8S2M	TMS		XIX		
T8S3	TMS		XIX		
T8S3M	TMS		XIX		
TVB-8	THM		XVIII		
VS-8	COU		XXI		
8LM3V	OS		VIII		
8L02B	OS			8L029□, 3BP1A*	
8L0291	OS		VIII	3BP1*	
8L029M	OS		VIII		
8L0301	OS		VIII	3DP1*	
8L030M	OS		VIII		
8L039V	OS		VIII	3JP7*	
O9A	REC		XI		
O9B	REC		XI		
O9D	REC		XI		
O9G	REC		XI		
O9I	REC		XI		
O9K	REC		XI		
O9L	REC		XI		
O9V	REC		XI		
O9YE	REC		XI		
O9ZH	REC		XI		
DG-TS9	REC		XI	D2A□	
G-9	TRI	SIN		GIJ65□	
GS-9	COU		XXI		
GS9B	TRI	SIN	III		
LD-9	TRI	SIN		GS-9B□	
MMT-9	TMS		XIX		
MS-9	COU		XXI		
P9			X	2N35*	
P9A			X		
R-9			XXII		
SG9S	DIO	SIN	V		
STSV-9	F-1	PHO	XV		
T9	TMS		XIX		
TVB-9	THM		XVIII		
VS-9	COU		XXI		
D10	REC		XI		
D10A	REC		XI		
D10B	REC		XI		
DGTS10	REC		XI	D2B□	
G10	TRI	SIN	III		
G-10A	TRI	SIN		GU-10A□	
G-10RA	TRI	SIN		GU-10B□	
GK0-1D	TRI	SIN		GK-200D□	
GS-1D	COU		XXI		
GT-10	TRI	SIN		G46□	
GU10A	TRI	SIN	III		
GU10B	TRI	SIN	III		
ISK1D			XX		
ISP1D			XX		
IST10			XX		
KMT-10	TMS		XIX		
MO-1D	TRI	SIN	III		
P10			X	2N35*	
R-1D			XXII		

GROUP I, NUMERICAL

TYPE NUMBER	KIND	TYPE	TABLE NO.	SIMILAR TYPES	COST SPEC. NO.
SG1DS	REG		V		
TO-10	PND	SIN		10P12S	
VG-10	POW		XII		
VG-10-30	POW		XII		
VG-10-45	POW		XII		
VG-10-55	POW		XII		
VG-10-80	POW		XII		
VG-10-110	POW		XII		
VG-10-150	POW		XII		
VK-10	POW		XII		
10LK2B	PR		V111		
10L043I	OD		V111		
10P12S	PND	SIN	II		
10ZH1L	PND	SIN	II	10ZH3L□	
10ZH3L	PND	SIN	II	10ZH1L□	
10ZH12S	PND	SIN	II	310A*	
D11	REC		XI		
FEU-11	PHM		XVI		
GI-11B	TRI	SIN	III		
GS-11	COU		XX1		
GU11A	TRI	SIN	III		
GU11B	TRI	SIN	III		
KMT-11	TMS		XIX		
LD11	TRI	SIN		GI-11B□	
MS-11	COU		XX1		
P11			X		
R-11			XX11		
VS-11	COU		XX1		
D12	REC		XI		
D12A	REC		X1		
OGTS12	REC		XI		
FEU-12	PHM		XVI		
GI-12B	TRI	SIN	III		
GS-12	COU		XX1		
GU12A	TRI	SIN	III	880*	
KMT-12	TMS		XIX		
L012	TRI	SIN		GI-12B□	
MMT-12	TMS		XIX		
MS-12	COU		XX1		
OS12/50D	•PND	SIN		G837#	
P12			X		
R-12			XX11		
12B1M	PND	DWD	II		
12B2M	PND	DWD	II		
12G1	TRI	DWD	II	12SR7*	
12G2	TRI	DWD	II	12SQ7*	
12K1M	PND	SIN	II		
12K3	PNO	SIN	II	12SK7*	
12K4	PND	SIN	II	12SG7*	
12K12B	PND	SIN		12K4□, 12SG7*	
12K17B	PND	SIN		12K3□, 12SK7*	
12KH3S	DWD	SIN	II	LG1	
12M1M	PND	TRI	II		
12N1	TRI	TWN		12N11S□, 12AH7GT*	
12N4P	TRI	TWN	II	12AY7*	
12N10	TRI	TWN		12N10S□, 12SC7GT*	
12N10M	TRI	TWN		12N10S□, 12SC7GT*	
12N10S	TRI	DUO	II	12SC7*	
12N11S	TRI	TWN	II	12AH7GT*	
12P4S	PND	SIN	II		
12P14S	BEA	SIN	II		
12P17L	PND	SIN	II		
12R1B	TRI	DWO		12G1□, 12SR7*	
12R17B	TRI	DWO		12G2□, 12SQ7*	
12S2	•TRI	SIN	II		
12S3S	•TRI	SIN	II	LD1□	
12ZH1	•PND	SIN		12ZH1L□	
12ZH1L	PND	SIN	II	12ZH1	
12ZH1M	PND	SIN	II		
12ZH3L	PNO	SIN	II		
12ZH8	PNO	SIN	II	12SJ7*	
12ZH17B	PND	SIN		12ZH8□, 12SJ7*	

GROUP I, NUMERICAL

TYPE NUMBER	KIND	TYPE	TABLE NO.	SIMILAR TYPES	COST SPEC. NO.
D13	REC		XI		
DGTS13	REC		XI		
FEU-13	PHM		XVI		
G-13	TRI	SIN	III		
GI-13	TRI	SIN	III		
GI-13B	TRI	SIN	III		
GM13	TET	SIN	III		
GU13	BEA	SIN	III	813*	
LI-13	IM		VIII		
MS-13	COU		XXI		
P13			X	2N43*	
P13A			X	2N34*	
P13B			X		
SG13P		DIO	SIN	V	
V13/3D	•DIO	SIN	IV	V1-003/13□	
VS-13	COU		XXI		
13LK1B	TV		VIII	5FP4*	
13LK2B	TV		VIII		
13LM4V	OS		VIII		
13LM31M	OS		VIII	5FP7*	
13LM31V	OS		VIII		
13LM56I	OS		VIII	5FP1*	
13LM57	OS		VIII	5FP7*	
13LM57D	OS		VIII		
13LK58K	OS		VIII		
13L01B	•		VIII		
13L02B	•		VIII	5CP1-A*	
13L03I	OS		VIII		
13L04I	OS		VIII		
13L05P	•		VIII	5CP7-A*	
13L06P	•		VIII	5FP7-A*	
13L036	OS		VIII	5FP7*	
13L036V	OS		VIII		
13L037A	OS		VIII		
13L037I	OS		VIII	5CP1*	
13L037M	OS		VIII		
13L048A	OD		VIII		
13L048I	OD		VIII	5SP1*	
13L048M	OD		VIII		
13L054A	OS		VIII		
13L054M	OS		VIII		
13L054V	OS		VIII		
13L0101M			VIII		
13L0102M			VIII		
13L0104A	TV		VIII		
13P1	•BEA	SIN		13P1M□, 13P1S□	
13P1M	BEA	SIN		13P1□, 13P1S□	
13P1S	BEA	SIN	II	13P1□, 13P1M□	
014	REC		XI		
D14A	REC		XI		
OGTS14	REC		XI		
FEU-14	PHM		XVI		
GI-14B	TRI	SIN	III		
LI-14	IM		VIII		
MS-14	COU		XXI		
P14			X	2N65*	
TV-14	THM		XVIII		
VS-14	COU		XXI		
DGTS15	REC		XI	D2N□	
FEU-15	PHM		XVI		
G-15A	TRI	SIN		GU-11A□	
G-15RA	TRI	SIN		GU-16B□	
G00-15	TRI	SIN		G-61□	
GU15	BEA	SIN	III		
IFK15-1			XX		
ISSH15			XX		
LI-15	IM		VIII		
P15			X	2N43*, OC6D4#	
SG15P		DIO	SIN	V	
TG-15/3	TRI	THY		TG1-5/3□	
TR-15/2	TRI	THY		TR-1-5/2□	
TV-15	THM		XVIII		



GROUP I, NUMERICAL

TYPE NUMBER	KIND	TYPE	TABLE NO.	SIMILAR TYPES	GOST SPEC. NO.
VG15/50DD	DIO	SIN		GG1-0.5/5□	
15A6S	PND	SIN	II		
15L1I	IC			LI-1□	
OGTS16	REC	XI		02P□	
FEU-16	PHM	XVI			
GI-16B	TET	SIN	III		
GU16B	TRI	SIN	III		
LG-16	DIO	SIN		2D2S□	
MS-16	COU	XXI			
P16		X		2N55*, 0C604#	
P16A		X			
P16B		X			
SG16P	DIO	SIN	V		
TV-16	TMM		XVIII		
VS-16	COU	XXI			
DGTS17	REC	XI			
FEU-17	PHM	XV			
FEU-17A	PHM	XVI			
G-17B	TRI	SIN	III		
GI-17	TRI	SIN	III	G&B□	
GU-17	BEA	TWN	III		
LI-17	IM		VIII		
MST-17	COU	XXI			
P17		X			
P17A		X			
P17B		X			
SG17S	DIO	SIN	V		
FEU-18	PHM	XV			
FEU-18A	PHM	XVI			
GI-18B	TRI	SIN	III		
GU-18	BEA	TWN	III		
GS-18	TRI	SIN		GK-2000□	
LI-18	VI		VIII		
P18		X			
P18A		X			
P18B		X			
SG18S	DIO	SIN	V		
18LK2B	TV		VIII	70P4*	
18LK3V			VIII		
18LK4B	TV		VIII		
18LK5B	TV		VIII		
18LK7B	TV		VIII		
18LK15	TV		VIII		
18LM3S	OS		VIII	7BP7A*	
18LM35V	OS		VIII		
18L01P			VIII	7BP7A*	
18L040B	TV		VIII	7JP4*	
18L047A	OD		VIII		
18L047V	OD		VIII		
FEU-19M	PHM	XV			
GI-19B	TRI	SIN	III		
GU-19	BEA	TWN	III		
P19		X			
SG19S	DIO	SIN	V		
19LK4B	TV		VIII		
FEU-20	PHM	XV			
GK20	TRI	SIN	III		
I-20/1.5	TRI	THY	VII		
IFK20		XX			
M-20/35	TRI	SIN		GM-1A□	
M020	TRI	SIN	III		
P20		X			
QV20-P18	*TET	SIN		GM1-B3#	
TR-20/15	TRI	THY		T2-1-6/15□	
V20/20	*DIO	SIN		V1-D.02/20□	
20LM1YE		VIII			
D21	*REC	XI			
DGTS21	REC	XI		07A□	
GI-21B	TRI	SIN	III		
GU21B	TRI	SIN	III		
P21		X			
P21A		X			

GROUP I, NUMERICAL

TYPE NUMBER	KIND	TYPE	TABLE NO.	SIMILAR TYPES	GOST SPEC. NO.
DGTS22	REC	XI		D7B□	
FEU-22	PHM	XV			
GI-22	TRI	SIN	III		
GU22A	TRI	SIN	III		
OGTS23	REC	XI		D7V□	
FEU-23	PHM	XVI			
GU23A	TRI	SIN	III		
GU-23B	TRI	SIN	III		
23LK1B	TV		VIII	9CP4*	
23LK2B	TV		VIII		
23LK7B	TV		VIII		
23LK8B	TV		VIII		
23LM3A	OS		VIII	9GP7*	
23LM34V	OS		VIII		
23L01P	OS		VIII	9GP7*	
23L051A	OS		VIII		
DGTS24	REC	XI		07G□	
FEU-24	PHM	XV			
GI-24A	TRI	SIN	III		
GU24A		III			
DGTS25	REC	XI		D70□	
FEU-25	PHM	XV			
GI-25	TRI	SIN	III		
GU25B	TRI	SIN	III		
ISK25		XX			
P25		X			
P25A		X			
P25B		X			
VK-25	POW	XII			
25P1	BEA	SIN	II	25L6*	
25P1S	BEA	SIN	II	25L6*	
OGTS26	REC	XI		07E□	
FEU-26L	PHM	XVI			
GU26A	TRI	SIN	III		
GU26B	TRI	SIN	III		
P26		X			
P26A		X			
P26B		X			
OGTS27	REC	XI		D7Z□	
FEU-27	PHM	XVI			
GU27A	TET	SIN	III		
GU27B	TET	SIN	III	B27-R*	
P27		X			
P27A		X			
GU28A	TET	SIN	III		
GU28B	TET	SIN	III		
M28	TRI	SIN	III		
P28		X			
FEU-29	PHM	XV			
G29	TRI	SIN	III		
GU29	TET	TWN	III	B29-B*	
P29		X			
P29A		X			
G00-30	TRI	SIN		GS-3B□	
GI-30	BEA	TWN	III	3E29*	
GMI-30	TRI	SIN	III		
GS-30	COU	XXI			
GU30A	TRI	SIN	III		
M-30/450	TRI	SIN		GMI-30□	
P30		X			
VG-30	POW	XII			
30LK1B	TV		VIII	31LK1B□	
30P1	BEA	SIN		30P1S□	
30P1M	*BEA	SIN		30P1S□	
30P1S	BEA	SIN	II	30P1M	
30TS1M	OIO	SIN	II	30VKH1□, 30TS6S□	
30TS6S	DIO	TWN	II	30VKH1□, 30TS14□	
30VD1	DIO	SIN	II	30TS1M□	
30VKH1	DIO	SIN	II	30TS6S□	
FEU-31	PHM	XVI			
GU31	TET	SIN	III		
31LK1B	TV		VIII		

BD7B-56



GROUP I, NUMERICAL					
TYPE NUMBER	KIND	TYPE	TABLE NO.	SIMILAR TYPES	COST SPEC. NO.
31LK2B	TV		VIII	12LP4*	
31LM32	OS		VIII	12DP7A*	
31LM32V	OS		VIII		
31LO1P			VIII	12DP7*	
31LO33	OS		VIII	12GP7*	
31LO33V	OS		VIII		
FEU-32	PHM		XVI		
G32	TRI SIN	III			
GU32	BEA TWN	III		832*	
FEU-33	PHM		XV		
GU33B	TET SIN	III			
GU34B	TET SIN	III			
FEU-35	PHM		XVI		
GU-35B	TET SIN	III			
35LK2B	TV		VIII		8815-58
G36	TRI SIN	III			
GK36	TRI SIN			GK-20□	
GU-36B	TET SIN	III			
GU-37B	TRI SIN	III			
GU-39A	TET SIN	III			
GU-39B	TET SIN	III			
M39	TRI SIN	III			
FEU-40	NSP		XVI		
GU-40B	TET SIN	III			
V4D/1DD	DIO SIN			V1-D.1/4D□	
4DLK1B	TV		VIII	16AP4*	
FEU-42	NSP		XVI		
K42	KLY		IX		
42LM2YE			VIII		
FEU-43	NSP		XVI		8814-58
43LK2B	TV		VIII		
43LK3B	TV		VIII		
43LK6B	TV		VIII		
43LK7B	TV		VIII		
43LK8B	TV		VIII		
FEU-44	NSP		XVI		
FEU-45	NSP		XVI		
45LM1B			VIII		
FEU-46	NSP		XVI		
G46	TRI SIN	III			
FEU-47	NSP		XVI		
G47	TRI SIN	III			
SB-47	PND SIN	II			
FEU-48	NSP		XVI		
K48	KLY		IX		
FEU-49	PHM		XVI		
G-49	TRI SIN			GS-4□	
GD-50	TRI SIN			G-46□	
GU50	PND SIN	III		L550#	
I-50/1.5	TRI THY	VII			
IFK50			XX		
L50	*PND SIN			GU50#	
M50	TRI SIN	III			
VG-50	POW		XII		
VK-50	POW		XII		
GM51A	TRI SIN	III			
SB-51	PND SIN	II			
STSV51	PHO		XV		
FEU-52	PHM		XVI		
FEU-53	PHM		XVI		
M53	TRI SIN	III			
53LK2B	TV		VIII		
53LK3B	TV		VIII		
53LK4TS			VIII		
53LK5B	TV		VIII		
G-54	TRI SIN			GS-6□	
R-54			XXII		
G-56	TRI SIN			G29□	
GM57	TRI SIN	III		M55D□, M457□, UB18D#	
M57	TRI SIN	III			
SO-57	PND SIN	II			
G-58	TRI SIN			GK-3000□	

GROUP I, NUMERICAL					
TYPE NUMBER	KIND	TYPE	TABLE NO.	SIMILAR TYPES	COST SPEC. NO.
GM60	TRI SIN	III		M6DD□□	
3S-6D	COU		XXI		
G61	TRI SIN	III			
G62	TRI SIN	III			
G-64	TRI SIN			G5-3B□	
G65	TRI SIN	III			
G68	TRI SIN	III			
GI-70B	TRI SIN	III			
GM-70	TRI SIN	III			
GM70B	TRI SIN	III			
ISP7D			XX		
LD70	TRI SIN			GI-70B□	
V7D/10DD	DIO SIN			V1-D.3/7D□	
GK71	PND SIN	III		G471□	
GU72	PND SIN	III			
M74	TRI SIN	III			
75S5-3D	*DIO SIN			SG2S□, OA3*	
GI-76B	TRI SIN	III			
GU80	PND SIN	III		OS450#, P8D0□□	
M80	TRI SIN	III			
GU81	PND SIN	III			
GM1-83	TET SIN	III		QV20-P18#	
G88	TRI SIN	III			
V0-88	DIO TWN			4VKH1□	
GM1-89	TET SIN	III		G-489□□	
GU89A	TRI SIN	III		889A*	
GU89B	TRI SIN	III		889R-A*	
M89	TRI SIN	III			
GM1-90	TET SIN	III		G-490□□	
GS90B	TRI SIN	III			
LD-90	TRI SIN			G5-90B□	
MTKH9D	TRI THY	VII			
R8-90			XXII		
TGI-90/8	TRI THY			TGI-1-90/8□	
G91	TRI SIN	III			
G-92	TRI SIN			GK-2D00□	
L-99	PTG SIN			6A2P□, 6BE6*	
G-100	TRI SIN			G-29□	
G-100A	TRI SIN			GK-3A□	
GD-100	TRI SIN			G-47□	
GKE10D	*TET SIN	III		GE-1#	
GM10D	TRI SIN	III			
I-100/1.0	TRI THY	VII			
I-100/5.0	TRI THY	VII			
ISSH10D-1			XX		
ISSH10D-3			XX		
L100	*PND DIO			6B2P#	
VG-100	POW		XII		
VK-100	POW		XII		
D101	REC		XI		
D101A	REC		XI		
LI-101	IC		VIII		
P101			X		
P101A			X		
D102	REC		XI		
D102A	REC		XI		
P102			X		
D103	REC		XI		
D103A	REC		XI		
P103			X		
S-103	TET SIN			GKE-1000□	
D104	REC		XI		
D104A	REC		XI		
L-104	PND SIN			6K4P□, 6BA6*	
P104			X		
D105	REC		XI		
D105A	REC		XI		
P105			X		
105S5-30	DIO SIN			SG3S□, OC3*	
D106	REC		XI		
D106A	REC		XI		
P106			X		

GROUP I, NUMERICAL

TYPE NUMBER	KIND	TYPE	TABLE NO.	SIMILAR TYPES	COST SPEC. NO.
S-106	TET	SIN		GKE-150□	
PI07			X		
UB107	*TRI	SIN		4S1□	
S-109	TET	SIN		GKE-300□	
UB110	*TRI	SIN		4S2□	
VU-1110	OIO	SIN	IV		
SB-112	PNO	SIN	II	4E1□	
SO-118	TRI	SIN		4S5□	
G120	TRI	SIN	III		
IFK120			XX		
TR-120/15	TRI	THY		TR-1-40/15□	
SO-122	PND	SIN		4P1□	
SO-124	PNO	SIN	II	4ZH5□	
VO-125	OIO	SIN	IV		
SK-127			XXII		
VG-129	OIO	SIN	IV		
UB-132	*TRI	SIN	II	4S3□	
P135			X		
TO-141	*TRI	SIN	II	3S1□	
TO-142	*TRI	SIN	II	3S2□, 3S9□	
SB-147	TET	SIN		4E2□	
SO-148	PND	SIN	II	4E3□	
GKE150	*TET	SIN	III	GE-2#	
GI-150	TRI	SIN	III		
GU150	TRI	SIN	III		7712-55
I-150/1.0	TRI	THY	VII		
M150	TRI	SIN	III		
150S5-30	*OIO	SIN		SG4S□, 003*	
SB-152	TRI	SIN	II		
UB-152	TRI	SIN	II	2S1□	
UB-153	TRI	SIN	II		
SB-154	PNO	SIN	II	2E1□	
SB-155	BEA	SIN		2P2□	
UB-155	*BEA	SIN	II	2E2□	
VG-161	OIO	SIN	IV		
VG-163	OIO	SIN	IV		
VG-176	DIO	SIN	IV		
UB-178	TRI	SIN	II		
SO-182	PNO	SIN	II		
UB-182	*TRI	SIN	II		
SO-185	TRI	SIN		4S5□	
U0186	*TRI	SIN	II	4S4□	
US-186	TRI	SIN		4S4□	
VO-188	OWD	SIN	IV	4VKH1#	
SB-190	PNO	SIN	II		
191P	TET	SIN	II		
VO-196	OIO	SIN	IV		
VO-197	DWO	SIN	IV		
GD-200	TRI	SIN		GS-4□	
I-200/1.5	TRI	THY	VII		
IFP200			XX		
IVS200/2	IGN	IV			
TGI-200	TRI	THY	VII	*TI-2□	
VG200	POW	XII			
VK-200	POW	XII			
VKV200	POW	XII			
0201A	REC	XI			
0201B	REC	XI			
02010	REC	XI			
0201G	REC	XI			
0201TS	REC	XI			
0201V	REC	XI			
0201YE	REC	XI			
0201ZH	REC	XI			
LI-201	IM	VIII			
P201		X			
P201A		X			
SG201S	OIO	SIN	V		
D202	REC	XI			
P202		X		2N6B*	
SG202B	OIO	SIN	V		
VO-202	OWD	SIN	IV		

GROUP I, NUMERICAL

TYPE NUMBER	KIND	TYPE	TABLE NO.	SIMILAR TYPES	COST SPEC. NO.
0203	REC	XI			
LI-203		VIII			
P203		X		2N6B*	
D204	REC	XI			
0205	REC	XI			
D206	REC	XI			
D207	REC	XI			
P207		X			
P207A		X			
0208	REC	XI			
P208		X			
P208A		X			
0209	REC	XI			
P209		X			
P209A		X			
0210	REC	XI			
P210		X			
P210A		X			
0211	REC	XI			
TG212M	TRI	THY	VII		
TG-213	TRI	THY	VII	PT-2#□	
SK-220		XXII			
SG226	OIO	SIN	V		
SG227	OIO	SIN	V		
VO-230	OIO	SIN	IV		
TG-235	TRI	THY	VII	PT-3*□	
VG-236	DIO	SIN	IV		
VG-237	OIO	SIN	IV		
VO-239	OIO	SIN	IV		
UB-240	TRI	SIN	II	2S2□	
SB241	*PND	SIN		2K1#, 2K1M□, S0241#	
S0241	*PNO	SIN		2K1#, 2K1M□, S0241#	
SB-242	PTG	SIN		2A1#	
SO-242	PTG	SIN	II	SB242, 2A1, 2A1M	
SB243	*TRI	OUO		2N1#, 2N1M#, S0243#	
SO-243	*TRI	TWN	II	2N1#	
SB244	*BEA	SIN		2P1#, S0244#	
SO-244	PNO	SIN	II	2P1#	
SB245	*PND	SIN		2ZH1M#	
LO-247	TWT	IX			
GK0-250	TRI	SIN		GK-1A#	
VG-252	OIO	SIN	IV		
G256	TRI	SIN	III		
S0257	*PND	SIN	II	2ZH4#	
SB258	*BEA	SIN		2P3#, 2P2M#, S0258#	
SO-258	*PNO	SIN	II	2P3#	
SB259	*TRI	OUO		4N1#	
S0259	*TRI	OUO		4N1#	
RB-280		XXII			
G-300	TRI	SIN		G68	
GI-300	TRI	SIN		GI-18B#	
GK-300	TRI	SIN		GU-8#	
GKE300	TET	SIN	III		
IFB300		XX			
SG301S	OIO	SIN	V		9103-59
0302	REC	XI			
P302		X			
SG302S	OIO	SIN	V		9103-59
0303	REC	XI			
P303		X			
P303A		X			
SG303S	OIO	SIN	V		9103-59
0304	REC	XI			
P304		X			
SG304S	DIO	SIN	V		
0305	REC	XI			
SG305K	REG	V			
SG306K	REG	V			
P314A		X			
P314B		X			
P314C		X			
P322		X			

GROUP I, NUMERICAL					COST SPEC. NO.
TYPE NUMBER	KIND	TYPE	TABLE NO.	SIMILAR TYPES	
TGI-325/16	TRI	THY		MTI-5□, TGI-1-325/16□	
I-1-350/0.8	TRI	THY	VII		
R-350			XXII		
R8-350			XXII		
VO-360	OIO	SIN	IV		
GO-400	TRI	SIN		G5-6□	
M400	TRI	SIN	III		
TG-400/15	TRI	THY		TRI-130/15□	
TG1400/3.5	TRI	THY		TGI-2-400/3.5□	
0401	MOO		XIII		
LI-401			VIII		
M401	TRI	SIN	III		
P401			X	2N112*	
P402			X	SB-100*	
0403A	MIX		XIII		
0403B	MIX				
0403V	MIX		XIII		
P403			X	OC614#	
P403A			X	OC614#	
P404			X		
P404A			X		
0405	OET		XIII		
0405A	OET		XIII		
0405AP	OET		XIII		
0405B	OET		XIII		
0405BP	DET		XIII		
P405			X		
P405A			X		
P406			X	GT-60#	
P407			X		
P408			X		
P409			X		
T-409	OIO	IGM	IV		
G410	TRI	SIN	III		
P410			X		
P410A			X		
T-410	OIO	IGM	IV		
410R	KLY		IX		
G411	PNO	SIN	III	KZH1□	
P411			X	AF114#	
P411A			X	AF114#	
T-411	OIO	IGM	IV		
G412	PNO	SIN	III		
G413	PNO	SIN	III	GZH2□	
G414	PNO	SIN	III		
P414			X		
P414A			X		
P414B			X		
P415			X		
P415A			X		
P415B			X		
P416			X		
P416A			X		
P416B			X		
P416V			X		
G417	TRI	SIN	III		
G418	PNO	SIN	III		
G422	PND	SIN	III		
G424	PND	SIN	III		
G425	PNO	SIN	III		
G430	TRI	SIN	III		
R8-430			XXII		
G431	TRI	SIN	III	G431A□	
G431A	TRI	SIN	III	G431	
G-431R	TRI	SIN		G5-40□	
G433	TRI	SIN	III	G433A□	
G433A	TRI	SIN	III	G433	
M435	TRI	SIN	III		
G441	TRI	SIN	III		
G-450	TRI	SIN		GK-200□	
OS450	PNNO	SIN		GJ80□, P800□	
R-450			XXII		

GROUP I, NUMERICAL					COST SPEC. NO.
TYPE NUMBER	KIND	TYPE	TABLE NO.	SIMILAR TYPES	
G-450	TRI	SIN	III		
M-451	TRI	SIN		GM-51A□	
G-452	TRI	SIN	III	G-431A□	
G-454	TRI	SIN	III	G5-3B□	
M457	TRI	SIN	II	M53□, UB180#, GM57□	
M-470	TRI	SIN		GM-70□	
G471	PNNO	SIN		GK71□	
G472	TRI	SIN	III		
G480	TRI	SIN		GI-17□	
G-483	TET	SIN		GMI-83□	
G484	TRI	SIN	III		
G-489	TET	SIN		GMI-89□	
G-490	TET	SIN		GMI-90□	
IFK500			XX		
IFP500			XX		
ISSH500			XX		
VGVS500	POW		XII		
P501			X		
P501A			X		
P502			X		
P502A			X		
P502B			X		
P502V			X		
P503			X		
P503A			X		
M600	TRI	SIN		GM60□	
P601			X		
P601A			X		
P601B			X		
0602A	VIO		XIII		
0602B	VIO		XIII		
0602V	OET		XIII		
P602			X		
P602A			X		
0603	VIO		XIII		
P604			X		
P604A			X		
P604B			X		
700AA	MAG		IX		
706AU	MAG		IX		
707A/B	KLY		IX		
714AU	MAG		IX		
LK-715	TV			18LK15□	
720AYE	MAG		IX		
723A/B	KLY		IX		
725A	MAG		IX		
LK-726	TV			18LK38□	
726	KLY		IX		
LO-729	OS			8L029□, 3BP1A*	
LO-730	OS			8L030□	
LO-731	OS			13LM31□	
LO-732	OS			31LM32□	
LO-733	OS			31L033□	
LO-734	OS			23LM34□	
LO-735	OS			18LM35□	
LO-736	OS			13L036□	
LO-737	OS			13L037□	
LO-738	OS			5L038□, 2AP1*	
LO-739	OS			8L039□	
LK740	TV			18L040□, 1JP4*	
LO-743	OS			10L043□	
L0747	OS			18L047□	
LO-748	OS			18L048□	
L0749	OS			13L049□	
GK750	TRI	SIN	III		1709255
L0751	OS			23L051□	
L0754	OS			13L054□	
M800	TRI	SIN	III		
P800	PNNO	SIN		GJ80□, US450#	
G807	BEA	SIN	III	807*	8380-57
0808	REG		XII		
0809	REG		XII		

GROUP I, NUMERICAL

TYPE NUMBER	KIND	TYPE	TABLE NO.	SIMILAR TYPES	GOST SPEC. NO
0810	REG		XII		
0811	REG		XII	811-A*	
0811	TRI	SIN	III		
0813	REG		XII		
G-813	BEA	SIN		GU-13□, 813*	
G-827	TET	SIN		GU-27H□, 827R*	
G-829	TET	TWN		GU-29□, 829-8*	
G-832	BEA	TWN		GU-32□, 832A*	
G837	PNNO	SIN	III	0512/500#, 837*	
G-880	TRI	TWN		GU-12A□, 880*	
G889	TRI	SIN	III	889-A*	
TG-884	TRI	THY		TG1-0.1/0.3□, 884*	
G891	TRI	SIN	III	891*	
G01000	TRI	SIN		G-29□	
GKE1000	TET	SIN	III		
M-1000	TRI	SIN		GM-10□□	
VGVI000	POW		XII		
VKVI000	POW		XII		
01001	REC		XI		
D1001A	REC		XI		
01002	REC		XI		
01002A	REC		XI		
01003A	REC		XI		
TG1050	TRI	THY		TG2-0.1/0.1□	
IFP1500			XX		
1502	OIO	SIN	IV	5TS9S	
1504	TRI	SIN	II		
1506	BEA	TWN	II		
1509	BEA	TWN	II		
1511	PNO	SIN	II		
1512	PNO	SIN	II		
1514	PNO	SIN	II		
G1625	BEA	SIN	III	1625*	
GK2000	TRI	SIN	III		
IFK2000			XX		
TG2050	TET	THY		TG1-0.1/1.3□, 2050*	
GK3000	TRI	SIN	III		7710-55
M-3000	TRI	SIN		GMI-1B□	
PI-3000	PNNO	SIN		GI-8□□	
GI-3100	TRI	SIN	III		
IFP4000			XX		
4671	TRI	SIN		6S1ZH□	
G-5000	TRI	TWN		G5-3B□	
IFP15000			XX		
IFK20000			XX		
G40011	TRI	SIN	III		
IFK80000			XX		



GROUP II, RECEIVING

TYPE NUMBER	KIND	TYPE	BULB	USE	CATHODE	E <sub>f</sub> v	I <sub>f</sub> ma	MAXIMUM				TYPICAL						CAPACITY			BASE
								E <sub>b</sub> v	I <sub>b</sub> ma	P <sub>p</sub> w	E <sub>b</sub> v	E <sub>92</sub> v	E <sub>91</sub> v	I <sub>b</sub> ma	I <sub>92</sub> ma	S <sub>m</sub> μmho/100	R <sub>p</sub> Ω	IN pf	OUT pf	f <sub>max</sub> mc	
06P2B	PND	SIN	T3F	AF	F	0.6	30	35	350U	0.1	30	30	90U	0.1	1	IM				5CL	
06ZH6B	PND	SIN	T3F	AF	F	0.6	20	35	350U	8M	30	30	150U	0.1	1	900K	5.0	3.0		5CL	
1A1P	PTG	SIN	T6		F	1.2	60	100		0.3	90	45	□1	3	500K	7.0	7.0		7AT		
1A2P	PTG	SIN	T6		F	1.2	30	90		0.3	90	45	□1	2		5.1	6.3		7AT		
1B1P	PND	DIO	T6		F	1.2	60	100	4	0.2	67	67	2	0.3	6	IM	2.2	2.4		6AU	
1B2P	PND	DIO	T6		F	1.2	30	90	2	0.1	60	45	900U	0.2	5	IM	1.8	2.1		6AU	
1E1P	TET	SIN	T5	EL	F	1.0	46				6	4	3	100U	0.4	1		3.5		TE2	
1E3P	TRI	SIN			F	1.3	24				8		3	300U		2		3.5			
1I2P	TRI	PND			F	1.2	60	90	2	0.2	60	45	1		25K	0.7	3.0			PT1	
1I2P	PND	TRI			F	1.2	60	90	2	0.2	60	45	1	0.3	2	650K	3.5	4.7		PT1	
1K1P	PND	SIN	T6		F	1.2	60	100		0.6	90	67	3	1.2	9	IM	3.5	7.5		6AR	
1K2P	PND	SIN	T6		F	1.2	30	90	3	0.3	60	45	1	0.3	7	IM	3.0	4.9		6AR	
1N3S	TRI	TWN	T10		F	1.2	120	150		1.0	120		5	□3	8	14K				7AB	
1P2B	PND	SIN	T3F	AF	F	1.3	50	50	8M		45	45	2	1	0.5	4	50K	3.0	6.0		5CL
1P3B	PND	SIN	T3F	AF	F	1.3	28	50	5M		45	45	2	1	0.3	3	50K	3.0	6.0		5CL
1P4B	PND	SIN	T3F	AF	F	1.3	20	50	0.2	4M	45	45	2	1	0.3	3	200K	3.0	6.0		5CL
1P24B	PND	SIN	T3B		F	1.2	12				150	125	14	1.2	27		7.3	4.0			
1S12P	TRI	SIN			F	1.2	30	90	0.3	0.2	60		1								
1TS1S	DIO	SIN	T10		F	0.7	185	15K	5		60		□1		9	16	19K	0.8	0.7	300	TS1
1TS7S	DIO	SIN	T10		F	1.3	200	30K	17				2				2.0				8HC
1TS11P	DIO	SIN	T6		F	1.2	200	20K	2				300U				1.5				8HC
1ZH2M	PND	SIN			F	1.2	30				70	70	1	0.6	0.5						DS3
1ZH17B	PND	SIN	T3B		F	1.2	60	90	5	0.5	60	45	2	0.1	14		3.7	2.7			
1ZH18B	PND	SIN	T3B		F	1.2	21	90	3	0.3	60	45	1	0.2	8	25K	3.7	2.7			
1ZH24B	PND	SIN	T3B		F	1.2	12				60	45	1	0.2	8	40K	3.6	2.4			
1ZH29B	PND	SIN	T3B		F	1.2	60				60	45	5	0.2	20	35K	4.9	3.3			
2A1	PTG	SIN		CN	H	2.0	160	160		0.7	120	70	4			150K	9.6	11.4			8A
2D1L	DWD	SIN	F10		H	2.2	130				50		2								DW3
2D1S	DIO	SIN	LIT		H	2.3	400	100	0.1				100U								3G
2D2S	DIO	SIN	F10		F	1.5	1500	200	40	5.0			40								3G
2D3B	DIO	SIN	T3F		F	2.2	110				150		5				2.4				
2D3S	DIO	SIN																			
2D7S	DIO	SIN	T6		W	1.4	2				300		3								
2D9S	DIO	SIN	T10		F	3.7	550	500	1												
2E1	TET	SIN			F	2.0	110	160		1.0	100	40	1	0.5	9	IM	9.0	9.0			TE5



GROUP II, RECEIVING

TYPE NUMBER	KIND	TYPE	BULB	USE	CATHODE	E <sub>f</sub> v	I <sub>f</sub> ma	MAXIMUM				TYPICAL						CAPACITY			BASE	
								E <sub>b</sub> v	I <sub>b</sub> ma	P <sub>b</sub> w	E <sub>b</sub> v	E <sub>q2</sub> v	E <sub>q1</sub> v	I <sub>b</sub> ma	I <sub>q2</sub> ma	S <sub>m</sub> μmho/100	μ	R <sub>p</sub> Ω	I <sub>H</sub> pf	OUT pf		f <sub>max</sub> mc
2E2	@	TET SIN			F	1.8	320			1.5	160	80	2	7	4.0	18		300K	8.3	9.0		TE6
2E2P		TET TWN	T8	EL	F	2.0	55				6	4	3	4.5U	0.7	0.1	1		4.0			TE3
2K1		PND			F	2.0	120	120		120	70	1	1	0.4	1.2	16		750K				
2K1M	@	PND SIN			F	2.0	120			150	70	1	1	3	1.1	14		1M				5Y
2K2M		PND SIN	T9		F	2.0	60	160		0.5	120	70	0.1	2	0.5	9		1M	5.4	8.1		5Y
2KH1L		DWD SIN			H	2.2	130				50			2					2.2			
2N1		TRI DUO			F	2.0	240	160		1.5	120	120	2	3	0.7	21	32		2.8	5.7		7AB
2P1		BEA SIN			F	2.0	185			0.2	120	120	2	4	0.7	18		150K				6X
2P1P		BEA SIN	T5		F	1.2	120	90		0.8	90	90	4	10	2.2	20		100K	5.5	4.0		7AV
2P2	@	BEA SIN			F	2.0	220			0.3	120	100	4	10	1.8	22		90K				
2P2P		BEA SIN	T5		F	1.2	60	90		0.4	90	60	4	3	0.8	11		170K	3.7	3.8		7BA
2P3		BEA SIN			F	2.0	230			0.5	160	120	6	10	1.7	20		80K				6X
2P9M		BEA SIN	T10		F	2.0	1000	300		8.0	250	150	5	35	1.5	25		40K	8.5	8.5		6X
2P19B		PND SIN	T3B		F	2.2	70	200		1.0	120	90	5	8	3.5	17		50K	4.5	7.0		PS6
2P29L		PND SIN	T9		F	2.2	120	200		2.0	160	120	6	10	2.0	19		50K	4.3	5.5		PS2
2P29P		PND SIN	T5		F	2.2	110	200		1.0	120	45		0.2	0.4	12		100K	4.9	2.0	120	PS8
2S1		TRI SIN			F	2.0	110	120		2.0	80			0.6		15	14		9K	3.6	3.0	
2S2		TRI SIN	T8		F	2.0	120	160		0.6	120			1		13	22		17K	2.8	2.7	
2S4S		TRI SIN		PA	F	2.5	2500	360		15.0	250	45		62		52	4	800K	7.5	5.5		5S
2S14B		TRI SIN	T3F		F	2.2	60	250		5	0.7	90	3	0.4		18	15	8400	2.8	2.1	300	TS2
2TS2S		DIO SIN	S12		H	2.5	1750	12K	100		4K			7								4AC
2VD8		DIO SIN			F	2.5	1750	12K	100													
2ZH1M	@	PND SIN	T9		F	2.0	320			0.5	160	80	2	7	1.5	18						PS8
2ZH2M		PND SIN			F	2.0	60	160		0.5	120	70	0.1	2	0.5	9		1M	5.4	8.1		5Y
2ZH4	@	PND SIN			F	2.0	275			1.2	200	100	7	14	2.4	18		110K				PS8
2ZH14B		PND SIN	T3B		F	2.2	30	90		5	0.5	90	45	2	0.8	12			4.5	6.0		PS6
2ZH15B		PND SIN	T3B		F	2.2	14	90		0.2	60	45		1	0.1	70			4.0	5.0		P4S
2ZH27L		PND SIN	F10		F	2.2	57	200		1.0	120	45		2	0.5	12		700K	5.3	4.9		PS3
2ZH27P		PND SIN	T5		F	2.2	57	120		1.0	120	45		1	0.5	10		0.2M	4.5	2.0		PS4
2ZH28L		PND SIN			F	2.2	28			1.0	120	45		2	0.5	12		0.2M	5.4	4.8		PS3
3A4S		PND SIN			F	3.2	100			150	90			13	2.2	19						P7S
3B4S		BEA SIN	T5		F	3.2	150			180	150	20		30	2.5	24						P8S
3S1		TRI SIN			F	2.5	1A			220		4		8		22	22	10K				
3S2		TRI SIN			F	2.5	1A			220		10		15		24	11	4K				
3S9		TRI SIN			F	2.5	1000			220	220	10		17		24	11		5.0	2.5		4F

GROUP II, RECEIVING

TYPE NUMBER	KIND	TYPE	BULB	USE	CATHODE	E <sub>f</sub> v	I <sub>f</sub> ma	MAXIMUM			TYPICAL						CAPACITY			BASE				
								E <sub>b</sub> v	I <sub>b</sub> ma	P <sub>p</sub> w	E <sub>b</sub> v	E <sub>g2</sub> v	E <sub>g1</sub> v	I <sub>b</sub> ma	I <sub>g2</sub> ma	S <sub>m</sub> μmho/100	μ	R <sub>p</sub> Ω	IN pf		OUT pf	f <sub>max</sub> mc		
3TS16S	DIO	SIN			H	3.2	220	25K	80				1							4AC				
4D5S	DIO	SIN	T4		H	4.0	240			10		5												
4E1	TET	SIN			F	4.0	75	200		2.0	160	80	3	8	350				8.0	6.3	TE5			
4E2	TET	SIN			F	4.0	150	200		2.0	160	80	3	18	400				10.5	8.0	TE5			
4E3	TET	SIN			H	4.0	1000	250		160	60	1	8	1.5	30				200K	6.5	4.5			
4F6S	BEA	SIN		PA	H	4.0	1100			10.0	250	16	34	6.0	25	200			80K					
4N1	TRI	DUO			F	4.0	2A			6.0	120		30	3.2										
4P1	PND	SIN			F	4.0	1A			240	140	11	22	6.0	21									
4P1L	PND	SIN	T10		F	4.2	325	250	50	7.5	200	150	20	10.0	60				30K	8.5	9.4	100		
4P10S	PND	SIN			F	4.0	1750			315	210	7	63	1.4	85									
4S1	TRI	SIN			F	4.0	70			120			8						11	8K				
4S2	TRI	SIN			F	4.0	70			160			4						13	25	18K			
4S3	TRI	SIN			F	4.0	155	200		3.0	160	6	15						21	9				
4S3S	TRI	SIN			H	4.4	330			5.0	100	4	18						30	12	4200	1.5	0.6	1K
4S4	TRI	SIN			F	4.0	1A			15.0	250	37	57						32	4	1K			
4S5	TRI	SIN			H	4.0	1A			240		3	6						17	32	20K			
4TS6S	DIO	SIN	T10		F	4.0	1750			1.0	50		7											
4TS14S	DIO	SIN	T11		F	4.0	1750	60	20	1.2	50		7											
4VD1	DIO	SIN			F	4.0	700			350			50											
4VKH1	DIO	TWN			F	4.0	2300	1K	560															
4VKH2	DIO	SIN			H	4.0	2000	2K	1200															
4ZH1L	PND	SIN	F10		H	4.2	225	250	11	2.0	150	75	2	0.5	16					1M	4.0	4.2	200	PS1
4ZH1P	PND	SIN	F10		H	4.2	225	250	11	2.0	150	75	7											
4ZH5	TET	SIN			H	4.0	1000	250		120	40	1	3	1.7	13					770K	14.0	4.5		
4ZH5S	PND	SIN		RF	H	4.0	1000			160	60		5	3.5	20						11.0	4.5		
5TS3S	DWD	SIN	S16		F	5.0	3000	2K	750				230											
5TS4M	DIO	DUO	T11		H	5.0	2000	2K	415	400			70											DW1
5TS4S	DIO	DUO	T14		H	5.0	2000	1K	375	500			62											DW4
5TS8S	DWD	SIN	T17		H	5.0	5000	2K	1200	30.0	500		400											DW2
5TS9S	DWD	SIN	F13		H	5.0	3000	2K	600	12.0	500		190											DW2
5TS9SE	DWD	SIN	F13		H	5.0	3000	2K	600	12.0	500		190											DW2
5TS12P	DIO	SIN	T7		H	5.0	770	5K	350	5.0	2K		50											DS1
5VKH2	DWD	SIN			H	5.0	2000	14H	375															
5VKH3	DWD	SIN			H	5.0	3000	15H	675															
6A2P	PTG	SIN	T5	CN	H	6.3	300	330	14	1.1	250	100	3	1.0	5					100K	7.0	8.6		7CH

GROUP II, RECEIVING

TYPE NUMBER	KIND	TYPE	BULB	USE	CATHODE	E <sub>f</sub> v	I <sub>f</sub> ma	MAXIMUM			TYPICAL						CAPACITY			f <sub>max</sub> mc	BASE
								E <sub>b</sub> v	I <sub>b</sub> ma	P <sub>p</sub> w	E <sub>b</sub> v	E <sub>g<sub>2</sub></sub> v	E <sub>g<sub>1</sub></sub> v	I <sub>b</sub> ma	I <sub>g<sub>2</sub></sub> ma	S <sub>m</sub> μmho/100	R <sub>p</sub> Ω	IN pf	OUT pf		
6A3P	GTB	SIN	M8	CN	H	6.3	300	150	1.2	75	75	4	0.5	7.0	12		500K	4.7	4.0	7DF	
6A7	PTG	SIN	M8	CN	H	6.3	300	300	1.1	250	100	4	8.5	4		360K	9.5	12.0	8R		
6A8	PTG	SIN	S11	CN	H	6.3	300	330	1.0	250	100	4	2.7	5		1M	12.5	12.5	8A		
6A10S	PTG	SIN	S11	CN	H	6.3	300	330	1.1	250	100	4	9.0	4			9.0	10.0	8R		
6B1P	DIO	PND			H	6.3	400			150		15						9.0	4.0		
6B1P	PND	DIO			H	6.3	400			250	250	2	2.7	290			700K	9.0	4.0	PD4	
6B2P	PND	DIO	T5	RF	H	6.3	300	300	2.1	250	100	1	6	1.6	27		600K	4.2	4.1	8E	
6B8S	PND	DWD	S12	RF	H	6.3	300	275	2.5	250	125	3	10	2.4	13			4.0	9.0		
6D3D	DIO	SIN	LIT		H	6.3	770	200		150		27								3G	
6D4ZH	DIO	SIN	ACO		H	6.3	150	365		30	165	5						0.9		4G	
6D6A	DIO	SIN	T2F		H	6.3	150	450	0.2	165		8						3.0			
6D8D	DIO	SIN	PEN		H	6.3	450	450	180U	0.1										5G	
6D10D	DIO				H	6.3	750			30	100	10						3.5			
6D14P	DIO	SIN	T7		H	6.3	1100	750		600	20	175								9CB	
6E5P	TET	SIN	T6		H	6.3	600	150	8.3	150	150	2	45	14.0	270		8K	16.0	2.3	TE1	
5F1P	TRI	PND	T7		H	6.3	430	250	1.5	100		2	13				4K	3.0	5.0	9AE	
6F1P	PND	TRI	T7		H	6.3	430	250	1.7	170	170	2	10	4.0	60		400K	0.5	3.4	9AE	
6F5M	TRI	SIN	T10		H	6.3	300	350		250		2	1	20	100					5M	
6F6S	PND	SIN		PA	H	6.3	700	375	11.0	250	250	16	34	6.5	25			7.5	11.0	7S	
6F7	TRI	PND	M11		H	6.3	300	110	0.5	100		3	3							PT2	
6F7	PND	TRI	M11		H	6.3	300	275	2.2	250	100	3	7	1.6	11					PT2	
6G1	TRI	DWD	M10		H	6.3	300	275	2.7	250		9	9				16	8500	3.6	2.8	8Q
6G2	TRI	DWD	M10		H	6.3	300	330	0.9	250		2	1	11	100		91K	3.2	3.0	8Q	
6G2P-K	TRI	DWD	T6		H	6.3	300			250		2	1	18	100						
6G3P	TRI	TRD			H	6.3	450	300	1.0	250		3	1	13	63		48K	2.0	1.2	TT1	
6G7	TRI	DWD			H	6.3	300	330	1.0	250		3	1	13	70		54K	5.0	3.8	TD3	
6I1P	TRI	PTG	T6		H	6.3	300	250	0.8	100		12	11				6K	2.6	2.0	9CA	
6I1P	PTG	TRI	T6		H	6.3	300	300	1.7	250	100	2	7	3.5	8		1M	5.1	7.4	9CA	
6K1B	PND	SIN	T3F		H	6.3	200	150	1.2	120	120	2	11	4.0	48		200K	4.8	3.8		
6K1L	PND	SIN	T9		H	6.3	150		1.0	150	75	2	3	0.9	13		700K	3.8	4.2	PS1	
6K1P	PND	SIN	T5		H	6.3	150	275	1.8	250	100	3	6	2.7	18		400K	3.4	3.0	7CM	
6K1ZH	PND	SIN	ACO		H	6.3	150	275	1.8	250	100	3	7	2.7	18		400K	3.0	3.0		
6K3	PND	SIN	M8		H	6.3	300	330	4.4	250	100	3	9	2.5	20		800K	6.0	7.0	8N	
6K4	PND	SIN	M8		H	6.3	300	330	3.3	250	125	1	12	4.4	47		900K	8.5	7.0	8BK	
6K4P	PND	SIN	T6		H	6.3	300	300	3.0	250	100	1	11	4.4	44		800K	6.5	5.5	7BD	

GROUP II, RECEIVING

TYPE NUMBER	KIND	TYPE	BULB	USE	CATHODE	E <sub>f</sub> v	I <sub>f</sub> ma	MAXIMUM				TYPICAL						CAPACITY			f <sub>max</sub> mc	BASE
								E <sub>b</sub> v	I <sub>b</sub> ma	P <sub>p</sub> w	E <sub>b</sub> v	E <sub>q2</sub> v	E <sub>q1</sub> v	I <sub>b</sub> ma	I <sub>q2</sub> ma	S <sub>m</sub> μmho	μ	R <sub>p</sub> Ω	IN pf	OUT pf		
6K7	PND	SIN	M10		H	6.3	300	330	3.0	250	100	3	7	1.7	16	830K	7.0	12.0	7R			
6K9S	PND	SIN	M10		H	6.3	300	330	4.4	250	100	3	9	2.5	20	800K	4.8	11.0	7R			
6KH2P	DIO	TWN	T9		H	6.3	300	450	0.5	150			10				3.8		6BT			
6KH6B	DIO	TWN			H	6.3	300	100											DW9			
6KH6S	DIO	TWN			H	6.3	300	465		165			9				4.0		8AN			
6KH7B	DIO	TWN	T3B		H	6.3	300	450	0.2	165			8				5.8		DW5			
6L7	PTG	SIN	M11	MX	H	6.3	300	330	1.5	250	100	3	5	6.6	11	1M	7.5	11.0	7T			
6N1P	TRI	TWN	T6		H	6.3	600	300	2.2	250			8			35	11K	3.1	1.8	9AJ		
6N2P	TRI	TWN	T6		H	6.3	340	300	1.0	250			1	2	21	98	47K	2.4	3.0	9AJ		
6N3P	TRI	TWN	T6		H	6.3	350	300	1.5	150			2	8	49	37	6K	2.7	1.4	8CJ		
6N4P	TRI	TWN	T6		H	6.3	300	300	1.5	250			4	3	17	41	23K	1.5	1.6	9AJ		
6N5P	TRI	TWN	T6		H	6.3	600	200	2.2	200			5	8	42	27	6500	3.0	1.7	9AJ		
6N5S	TRI	TWN	S16	PA	H	6.3	2500	250	13.0	90			30	60	45	3	460	9.5	5.0	8BD		
6N6P	TRI	TWN	T7		H	6.3	600	300	4.8	120			2	30	105	20	1800	4.4	1.9	9AJ		
6N7	TRI	TWN	M9		H	6.3	800	300	1.0	250			7	23	20	32	16K			9AJ		
6N7S	TRI	TWN	T9		H	6.3	810	300	6.0	300			6	4	16	35	2200	1.6	3.2	8B		
6N8S	TRI	TWN	T8		H	6.3	600	330	2.7	250			8	9	26	20	8K	2.8	3.8	8BD		
6N9S	TRI	TWN	T8		H	6.3	300	275	1.1	250			2	2	16	70	44K	3.0	2.8	8BD		
6N10S	TRI	TWN	T11		H	6.3	300	275	11.0	250			2	2	13	70	54K	1.4	0.2	8S		
6N12S	TRI	TWN	T11		H	6.3	900	300	4.2	180			7	23	64	17	2700			8BD		
6N13S	TRI	TWN	S16		H	6.3	2500	250	13.0	90			30	80	50	2	460	7.0	9.0	8BD		
6N14P	TRI	TWN	T5		H	6.3	350	180	1.5	90			1	10	68	25	3200	4.9	2.9	9DD		
6N15	TRI	TWN			H	6.3	450			100			9	9	56	38						
6N15P	TRI	TWN	T5		H	6.3	450	300	1.6	100			1	9	56	38	6800	2.0	1.4	7BF		
6N16B	TRI	TWN	T3B		H	6.3	400	200	0.9	100			2	6	50	25	5K	2.5	1.6	TD1		
6N17B	TRI	TWN	T3B		H	6.3	400	250	0.9	200			1	3	38	75	20K	2.8	1.5	TD1		
6N23P	TRI	TWN	T7		H	6.3	300	300	1.8	120			15	15	127	32		3.6	2.1	9AJ		
6P1P	BEA	SIN	T7		H	6.3	500	250	12.0	250	250	12	44	7.0	49	50K	7.8	5.7	PS9			
6P2P	PND	SIN			H	6.3	450			120			5	35	12.0	80						
6P3S	BEA	SIN	T14		H	6.3	900	400	20.0	250	250	14	72	8.0	60	22K	11.0	8.2	6CC			
6P4	PND	SIN			H	6.3	300			180	180	9	15		23			5.5	7.0	7S		
6P6B	PND	SIN			H	6.3	700	375		250	250	16	34	6.5	15			6.0	12.0	7S		
6P6S	BEA	SIN	T9	PA	H	6.3	450	350	13.2	250	250	12	45	4.5	41	52K	9.5	9.5	7S			
6P7S	BEA	SIN	T16		H	6.3	900	6K	20.0	250	250	14	72	8.0	59	32K	11.5	6.0	5BT			
6P8S	PND	SIN	T11		H	6.3	300			180	180	9	15		24							



GROUP II, RECEIVING

TYPE NUMBER	KIND	TYPE	BULB USE	CATHODE	E <sub>r</sub> v	I <sub>r</sub> ma	MAXIMUM				TYPICAL					CAPACITY			BASE	
							E <sub>b</sub> v	I <sub>b</sub> ma	P <sub>p</sub> w	E <sub>b</sub> v	E <sub>q2</sub> v	E <sub>q1</sub> v	I <sub>b</sub> ma	I <sub>q2</sub> ma	$\frac{S_m}{\mu mho}$ 100	$\mu$	R <sub>p</sub> $\Omega$	IN pf		OUT pf
6P9	BEA	SIN	M10	PA	H	6.3	650	330	9.0	300	150	3	30	6.5	117	80K	13.0	7.5	8Y	
6P9E	BEA	SIN	M10	PA	H	6.3	560	330	9.0	300	150	3	25	5.8	112	100K			8Y	
6P13S	BEA	SIN	T10	H	6.3	1300	450	130	14.0	200	200	19	60	8.0	95	25K	14.0	18.0	5BT	
6P14P	BEA	SIN	T6	H	6.3	760	300	66	12.0	250	250	6	48	5.0	113	20K	11.0	7.0	9CV	
6P15P	BEA	SIN	T6	H	6.3	760	330	90	12.0	300	150	2	30	4.5	147	100K	14.0	7.0	P1S	
6P17S	BEA	SIN		H	6.3	900	500	20.0	250	250	14	72	8.0	59	32K	11.5	6.0	9CV		
6P18P	BEA	SIN	T6	H	6.3	760	250	75	12.0	170	170	6	53	8.0	110	23K	11.5	6.0	9CV	
6P20S	BEA	SIN	T16	H	6.3	2500	700	200	23.0	175	175	30	90	6.0	85	24.0	10.0	5BT		
6P21S	BEA	SIN		F	6.3	750	600	100	18.0	600	200	16	36	5.0	40	20K	8.2	6.5	P14	
6P31S	BEA	SIN	T11	H	6.3	1300	300	10.0	100	100	9	80	8.5	125		18.0	8.5	PS7		
6S1P	TRI	SIN	T5	RF	H	6.3	150	275	1.8	250		7	6		22	26	11K	1.4	1.1	7BS
6S1ZH	TRI	SIN	ACO	H	6.3	150	275	1.8	250		7	6			22	26	11K	1.0	0.6	600
6S2B	TRI	SIN	M9	H	6.3	300	300	2.5	250			9	9		26	20	7K	3.4	3.6	6Q
6S2P	TRI	SIN	T5	H	6.3	400	165	2.5	150		1	14			115	48	4200	5.3	4.2	7BQ
6S2S	TRI	SIN	T9	H	6.3	300	330	20	2.7	250		8	9		25	20	8000	3.0	4.5	6Q
6S3B	TRI	SIN	T3F	H	6.3	150	300	12	2.5	270		8			22	14	6400	2.5	3.9	
6S3P	TRI	SIN	T6	H	6.3	300	160	35	3.0	150		1	16		200	50	2600	6.5	1.5	TS4
6S4B	TRI	SIN	M9	H	6.3	300	300	0.4	250		1	1			15	100	66K	2.0	12.0	5M
6S4P	TRI	SIN	T6	H	6.3	300	160	35	3.0	150		1	16		200	50	2600	11.5	3.7	TS4
6S4S	TRI	SIN	S16	PA	F	6.3	1000	360	15.0	250		45	60		54	4	840			5S
6S5	TRI	SIN		H	6.3	300			1.2	250		8			22	20		3.0	11.0	6Q
6S5D	TRI	SIN	LIT	H	6.3	770	300	25	6.5	250		1	25		47	42	9K	2.3	0.5	3G
6S5S	TRI	SIN	M9	H	6.3	300	350	2.7	250		6	8			22	20	9K	3.8	12.0	6Q
6S6B	TRI	SIN	T3F	H	6.3	200	250	14	1.4	120		2	9		50	25	5K	3.3	3.5	500
6S7B	TRI	SIN	T3F	H	6.3	200	300	7	1.4	250		2	15		40	65	16K	3.3	3.4	
6S8S	TRI	SIN	T10	H	6.3	300	500	3.6	300		10	11			30	20	6700	2.2	0.6	TS5
6S9D	TRI	SIN	LIT	H	6.3	570	300	25	5.5	250		1	15		100	100	10K	2.9	10.1	900
6S10D	TRI	SIN	LIT	H	6.3	920	5K	8500	9.0											3G
6S11D	TRI	SIN	PEN	H	6.0	176	120	30	3.6	110		2	20		65	17	2500	2.5	0.1	18H
6S13D	TRI	SIN	ROC	H	6.3	770	350	9.0	300		4	21			52	32	6200	2.7	10.1	36H
6S15P	TRI	SIN	T6	H	6.3	440	160	7.5	150		4	12			45			10.5	1.5	T2S
6S16D	TRI	SIN	PEN	H	6.3	192	170	35	3.6	135		4	12		60	17	2800	2.5	0.1	18H
6S17K	TRI	SIN	ROC	H	6.3	400	200	2.0	175		1	10			120	125	10K	3.5	10.1	
6S18S	TRI	SIN	T20	H	6.3	6600	450	60.0	120		20	550			400	2	60			TS6
6S19P	TRI	SIN	T7	H	6.3	1000	350	110	11.0	100		20	95		75	4	500	6.5	6.0	TS7

GROUP II, RECEIVING

TYPE NUMBER	KIND	TYPE	BULB	USE	CATHODE	E <sub>f</sub> v	I <sub>f</sub> ma	MAXIMUM				TYPICAL						CAPACITY		f <sub>max</sub> mc	BASE
								E <sub>b</sub> v	I <sub>b</sub> ma	P <sub>p</sub> w	E <sub>b</sub> v	E <sub>q2</sub> v	E <sub>q1</sub> v	I <sub>b</sub> ma	I <sub>q2</sub> ma	S <sub>m</sub> μmho	μ	R <sub>p</sub> Ω	IN pf		
6S20S	TRI	SIN	T13	H	H	6.3	200	25K	□2	25.0	25K	8	1	2	2K	10M				TS8	
6S21D	TRI	SIN	PEN	H	H	6.3	176			3.6	110	2	20	65	16	2500	2.5	0.1			
6SK7	TRI	PND		H	H	6.3	300	100				3	3	5	8		2.5	3.0			
6SK7	PND	TRI		H	H	6.3	300	250	100			3	6	11			3.2	12.5			
6TS4P	DWD	SIN	T6	H	H	6.3	600	1K	300	3.0	350		37							DW6	
6TS4S	DIO	SIN		H	H	6.3	600	1K	300				75								
6TS5S	DWD	SIN	T10	H	H	6.3	600	1K	300	400		37								DW7	
6TS10P	DIO	SIN	T6	H	H	6.3	1050	4K	450	1K		120					5.0			98D	
6TS13P	DIO	SIN	T7	H	H	6.3	950	□2K	900	8.0	650	120								68Y	
6TS15S	DIO	TWN	T13	H	H	6.3	1430	1K	375	350		62								8AN	
6TS17S	DIO	SIN	T10	H	H	6.3	3000	4K	1200			2	26	2.7	290		9.0	4.6		PS5	
6VKH1	DWD	SIN	T6	SM	H	6.3	600	1K	200	4.5	250	250	70							DW7	
6YE1P	TRI	SIN	T5	ID	H	6.3	300	250		0.2	250	4	5	12	24					ID1	
6YE5S	TRI	SIN	T11	ID	H	6.3	300	250			250	4	5	12	24					8B	
6ZH1B	PND	SIN	T3F	H	H	6.3	200	150	14	1.2	120	120	□8	3.5	48	200K	4.8	3.8			
6ZH1L	PND	SIN	F10	H	H	6.3	150			2.0	150	75	2	0.2	15	1M	4.0	4.2	200	PS1	
6ZH1P	PND	SIN	T6	UF	H	6.3	170	200	20	1.8	120	120	2	7	3.0	300K	4.3	2.4	120	78D	
6ZH1ZH	PND	SIN	ACO	H	H	6.3	150	250		0.5	250	100	3	2	0.7	16	1M	3.5	3.0		
6ZH2B	PND	SIN	T3F	RF	H	6.3	200	150	14	0.9	120	120	2	□6	6.0	500K	4.9	4.1			
6ZH2M	PND	SIN	T6	RF	H	2.0	60			0.5	120	70	□1	2	0.5	9		5.4	8.1		
6ZH2P	PND	SIN	T6	RF	H	6.3	170	300	20	1.8	120	120	6	5.0	39	100K	4.5	2.4		7CM	
6ZH3	PND	SIN	M8	RF	H	6.3	300	300		3.3	250	150	1	11	4.0	900K	8.5	7.0		8BK	
6ZH3M	PND	SIN		H	H	6.3	450	300	3.0	300	200	□2	10	2.5	50	700K	11.0	5.0		8N	
6ZH3P	PND	SIN	T5	UF	H	6.3	300	330		2.5	250	150	7	2.0	50	800K	6.5	1.5		78D	
6ZH4	PND	SIN	M10	H	H	6.3	450	330		3.3	300	150	10	2.2	90	900K	11.0	5.0		8N	
6ZH4E	PND	SIN	M10	H	H	6.3	450	330		2.5	300	150	9	2.2	85					8N	
6ZH4P	PND	SIN	T5	H	H	6.3	300	300	20	3.5	250	150	1	11	4.3	900K	6.3	6.3		78K	
6ZH5A <sup>e</sup>	PND	SIN		H	H	6.3	450			250	100		10	2.5	90					78K	
6ZH5B	PND	SIN	T3F	H	H	6.3	250	150	28	2.6	120	120	2	15	6.0	100	100K	6.0	4.0		
6ZH5P	BEA	SIN	T6	H	H	6.3	450	300	20	3.6	300	150	2	10	2.0	90	350K	8.5	2.2		78K
6ZH6S	PND	SIN	M10	H	H	6.3	500			2.5	250	100	2	10	2.5	75	2M	9.5	6.2		7R
6ZH7	PND	SIN	M10	RF	H	6.3	300	330		0.8	250	100	3	2	0.6	12	1M	7.0	12.0		7R
6ZH8	PND	SIN	S11	RF	H	6.3	300	330		2.8	250	100	3	3	0.8	16	2M	6.0	7.0		8N
6ZH8S	PND	SIN		H	H	6.3	300			100	100	3	3	0.9	16						8Y

GROUP II, RECEIVING

TYPE NUMBER	KIND	TYPE	BULB	USE	CATHODE	$E_i$ v	$I_f$ ma	MAXIMUM			TYPICAL						CAPACITY			BASE	
								$E_b$ v	$I_b$ ma	$P_p$ w	$E_{g_2}$ v	$E_{g_1}$ v	$I_b$ ma	$I_{g_2}$ ma	$S_m$ $\mu$ mho	$\mu$	$R_p$ $\Omega$	IN	OUT		$f_{max}$ mc
6ZH9B	PND	SIN	T4F		H	6.3	310				120	120	15	170			7.5	3.3			
6ZH9P	PND	SIN	T6		H	6.3	300	250	35	3.0	150	150	1	15	5.0	175	100K	8.5	3.3	9EQ	
6ZH10B	PND	SIN	T3F		H	6.3	250	150	28	0.8	120	120	1	11	9.0	50	100K	6.5	4.5		
6ZH10P	PND	SIN	T6		H	6.3	300	250	35	3.0	200	100	1	6	5.5	95	100K	8.9	3.9	9EQ	
6ZH11P	PND	SIN	T6		H	6.3	440	150	40	4.9	150	150	2	25	5.0	28	30K	14.0	3.5	9EQ	
6ZH13L	PND	SIN	M12		H	6.3	300				250	250	17	10	1.4	77				P18	
6ZH20P	DIO	BEA	T6		H	6.3	450			6			31							PD1	
6ZH20P	BEA	DIO	T6		H	6.3	450			3.0	150	150	1	18	4.0	170	600K	8.5	2.5	245	
6ZH21P	DIO	BEA	T6		H	6.3	350			12			35							PD2	
6ZH21P	BEA	DIO	T6		H	6.3	350	200		3.0	150	150	1	17	4.0	170	60K	5.0	1.8	400	
6ZH22P	DIO	BEA	T6		H	6.3	480			12			65							PD2	
6ZH22P	BEA	DIO	T6		H	6.3	480	200		5.5	150	150	1	28	7.0	300	60K	8.5	2.4	440	
6ZH23P	PND	DBA			H	6.3	440	150	40	2.4	150	150	2	12	7.5	140	14.0	3.5		PD3	
6ZH32P	PND	SIN	T6		H	6.3	200	300	6	1.0	250	140	2	3	1.0	18	3M	4.0	5.5	P17	
7P12S	PND	SIN	S12		H	7.3	850	200	60	8.0	135	135	15	31	7.0	28		7.7	9.5	5F	
7ZH12S	PND	SIN	S12		H	7.3	425	250		1.9	250	135	3	5	1.1	18	500K	6.1	15.0	6F	
10P12S	PND	SIN	S12		H	10.0	640	200	60	8.0	180	135	15	31	7.0	21	20M	7.7	9.7	5F	
10ZH1L	PND	SIN	F10		H	10.0	93	250	11	2.0	150	75	2	7	0.5	16	1M	4.0	4.2	200	
10ZH3L	PND	SIN	F10		H	10.0	93	250	11	2.0	150	75	2	7	0.5	16	1300	4.0	4.2	200	
10ZH12S	PND	SIN	S12		H	10.0	320	250		1.9	250	135	3	6	1.0	18	500M	6.1	15.0	6F	
12B1M	PND	DWD			H	12.5	220			25	25	1	1	0.4	19	7500				PD5	
12B2M	PND	DWD			H	12.5	150			25	25	1	1	0.3	8	150K				PD6	
12G1	TRI	DWD			H	12.6	150	275		2.7	250		9	9		19	16	8500	3.6	2.8	8Q
12G2	TRI	DWD			H	12.6	150	330		0.9	250		2	1		11	100	90K	3.2	3.0	8Q
12K1M	PND	SIN			H	12.5	225			25	25	2	2	0.5	14	200K				7R	
12K3	PND	SIN			H	12.6	150	330		4.4	250	100	1	9	2.5	20	800K	6.0	7.0	8N	
12K4	PND	SIN			H	12.6	150	330		3.3	250	125	1	11	4.4	47	900K	3.3	8.5	8N	
12KH3S	DWD	SIN	F10		H	12.6	73	250	20	0.1			1				0.5			1G	
12M1M	PND	TRI			H	12.5	225			25	25	1	1	0.3	19	7500				DW8	
12N4P	TRI	TWN			H	12.6	150			1.5	250		4	3		18	40	22K	1.6	1.6	9AJ
12N10S	TRI	DUO	T11		H	12.6	150	275		1.1	250		2	2		13	70	54K	1.5	0.2	8S
12N11S	TRI	TWN			H	12.6	150			1.8	180		6	7		19	16	8500	3.2	2.6	8BE
12P4S	PND	SIN	T11		H	12.6	160			250	250	12	38			38					7S
12P14S	BEA	SIN			H	12.6	150			7.5	250	250	12	30		30					7S
12P17L	PND	SIN	F11		H	12.6	325	250	60	7.5	150	150	20	35	5.0	70	10.0	8.5	120		P3S



GROUP II, RECEIVING

TYPE NUMBER	KIND	TYPE	BULB	USE	CATHODE	$E_t$ v	$I_t$ ma	MAXIMUM			TYPICAL						CAPACITY			$f_{max}$ mc	BASE
								$E_b$ v	$I_b$ ma	$P_p$ w	$E_{g2}$ v	$E_b$ v	$E_{g2}$ v	$E_{g1}$ v	$I_{g2}$ ma	$I_b$ ma	$\mu$	$R_p$ $\Omega$	IN pf		
12S2	TRI	SIN			H	12.6	150	250	8	9	20	20	3.4	3.6	8T3						
12S3S	TRI	SIN			H	12.6	100	300	4	27	30	12	4.100	0.6	11H TS3						
12ZH1L	PND	SIN	F10		H	12.6	75	250	2	7	0.5	16	4.0	4.2	200						
12ZH1M	PND	SIN			H	12.5	225	25	25	2	0.5	14	200K	7R							
12ZH3L	PND	SIN	F10		H	12.6	75	250	2	7	0.5	16	1300	4.0	4.2	PS1					
12ZH8	PND	SIN	F10		H	12.6	150	330	3	3	0.8	16	2M	6.0	7.0	8N					
13P1S	BEA	SIN		PA	H	13.0	765	6.0	110	80	2	52	15.5	10.5							
15A6S	PND	SIN			H	15.0	300	180	135	48	25	30K									
25P1	BEA	SIN			H	25.0	300	10.0	110	110	80	85									
25P1S	BEA	SIN			H	25.0	300	10.0	110	110	80	85									
30P1S	BEA	SIN	T11	PA	H	30.0	300	7.0	110	110	7	70	12.0	11.0	7S						
30TS1M	DIO	TWN			H	30.0	300	300	300	500	90	2500			5AA						
30TS6S	DIO	TWN			H	30.0	300	300	300	500	60				8AN						
30VD1	DIO	SIN			H	25.0	300	25.0	300	500	500				48Q						
30VKH1	DIO	SIN			H	30.0	300	300	300	500	60				8AN						
SB-47	PND	SIN			H	4.0	150	160	120	1	5	0.7	16	250K							
SB-51	PND	SIN			H	4.0	80	240	80	1	3	0.6	10	600K							
SO-57	PND	SIN			H	4.0	1A	240	100	1	3	0.8	30	500K							
SB-112	PND	SIN			H	4.0	80	160	80	1	2	0.6	6	500K							
SO-124	PND	SIN			H	4.0	1A	160	60	2	5	3.5	20								
UB-132	TRI	SIN			F	4.0	150	3.0	160	6	15	21	9	4K	4F						
TO-141	TRI	SIN	S17		F	2.6	1000	220	220	3	14	26			4F						
TO-142	TRI	SIN	S17		F	2.6	1000	220	220	7	23	25									
SO-148	PND	SIN			H	4.0	1A	240	80	2	7	1.0	16	200K							
SB-152	TRI	SIN			F	2.0	120	240	80	2	7	1.0	14	10K							
UB-152	TRI	SIN			F	2.0	120	120	120	4	6	30	14	5K							
UB-153	TRI	SIN			F	2.0	200	100	100	6	8	25	10	4K							
SB-154	PND	SIN			F	2.0	90	160	60	1	3	0.4	12	290K							
UB-155	BEA	SIN			F	2.0	230	0.2	100	60	2	6	1.5	100K							
UB-178	TRI	SIN			F	2.0	120	100	100	2	2	11	33	30K							
SO-182	PND	SIN			H	4.0	1100	240	100	1	7	2.0	25	800K							
UB-182	TRI	SIN			F	4.0	150	3.0	240	6	12	24	9	4K	4F						
UO186	TRI	SIN	S16		F	4.0	1000	15.0	250	37	57	32	4	1K	5Y						
SB-190	PND	SIN			F	2.0	100	160	120	1	1	0.4	12	420K							
191P	TET	SIN	T6	EL	H	1.0	46	6	3	4	100	500			TE2						



GROUP II, RECEIVING

TYPE NUMBER	KIND	TYPE	BULB	USE	CATHODE	$E_t$ v	$I_t$ ma	MAXIMUM			TYPICAL							CAPACITY		$f_{max}$ mc	BASE
								$E_b$ v	$I_b$ ma	$P_p$ w	$E_b$ v	$E_{g2}$ v	$E_{g1}$ v	$I_{b2}$ ma	$I_{g2}$ ma	$S_m$ $\frac{\mu mho}{100}$	$R_p$ $\Omega$	IN pt	OUT pt		
UB-240	TRI SIN	S9	CN		F	2.0	120	0.6	120	3	15	22	14K	2.8	2.8	5S					
SO-242	PTG SIN				H	2.0	160	1.0	120	3	21	1	7.0	8.6	7Z						
SO-243	TRI TWN				F	2.0	240	1.5	120	3	32	16K	2.8	3.4	7AB						
SO-244	PND SIN				F	2.0	185	1.5	120	4	18	270	150K	7.0	6X						
SO-257	PND SIN	S10			F	2.0	300	200	100	7	13				P19						
SO-258	PND SIN				F	1.8	320	2.0	160	10	20	160	80K	5.4	7.5	6X					
M-457	TRI SIN				F	4.0	2100	50.0	1K	70	70	8	1K								
1504	TRI SIN	LIT			H	6.3	770	6.5	250	25	47	42	9K	2.3	0.5	36					
1506	BEA TWN	T19			H	12.6	1120	15.0	400	110					78P						
1509	BEA TWN	T19			H	12.6	800	15.0	500	72					78P						
1511	PND SIN	M10			H	6.3	450	3.3	300	150	10	2.2	90		8N						
1512	PND SIN	M10			H	6.3	650	9.0	300	150	3	5.7	117		8Y						
1514	PND SIN	M10			H	6.3	300	2.8	250	100	3	0.8	17		8Y						











GROUP III, POWER

TYPE NUMBER	KIND	TYPE	BULB USE	CATHODE	E <sub>f</sub> v	I <sub>f</sub> ma	MAXIMUM				TYPICAL						CAPACITY			f <sub>max</sub> mc	BASE			
							E <sub>b</sub> v	I <sub>b</sub> ma	P <sub>p</sub> w	E <sub>b</sub> v	E <sub>g2</sub> v	E <sub>g1</sub> v	I <sub>b</sub> ma	I <sub>g2</sub> ma	S <sub>m</sub> μmha/100	μ	R <sub>p</sub> Ω	IN pf	OUT pf					
G413	PND	SIN			20.0	500	750			40.0	750	250	55	90	15.0	45					11.0	10.5		P10
G414	PND	SIN			20.0	1400	1K			1 H	1K	250	50	65	10.0	60					21.0	19.0		P15
G417	TRI	SIN			5.0	1150				20.0	400					10	19				1.9	1.0		T59
G418	PND	SIN		F	5.0	900	400			20.0	400	225	50	85	20.0	40					12.5	10.0		
G422	PND	SIN			20.0	3250	1K			1 H	750	300	60	180	40.0	30					15.5	15.5		
G424	PND	SIN			20.0	4600	1K			2 H	1K	400	140	300	80.0	50					27.0	33.0		
G425	PND	SIN			20.0	22A	4K			H7.5	4K	1K	100	350	70.0	40					21.0	18.0		
G430	TRI	SIN			22.0	51A	12K			10 K						45								
G431	TRI	SIN	W16	W	22.0	102A	15K			20 K	5K			3A	120	50					25.0	1.5	25	
G431A	TRI	SIN	W	W	22.0	102A	15K			12A	20 K	5K		3A	120	50					25.0	1.5	25	
G433	TRI	SIN	T46	W	33.0	210A	15K			60 K	6K			5A	320	45					80.0	67.0	20	
G433A	TRI	SIN		W	33.0	210A	15K			50A	60 K	6K		5A	320	45					80.0	6.0	20	
M435	TRI	SIN			20.0	24A				1 K	5K				60	9								
G441	TRI	SIN		W	11.0	51A				K2.5	7K				40	40								
G-450	TRI	SIN	W38	W	16.0	51A	10K			10 K	5K			4A	70	44								20
G-452	TRI	SIN	W40	W	22.0	102A	15K			20 K	5K			4A	125	40								25
G-454	TRI	SIN	W38	W	22.5	71A	10K			20 K	5K			4A	100	45								20
G472	TRI	SIN			2.5	14A				1 H		18K			25	140								
G484	TRI	SIN	A30	W	22.0	60A	9K			5 K	3K			1A		9								23.0
GK750	TRI	SIN			5.0	10A				H2.5	3K				66	37					5.8	2.9	40	
M800	TRI	SIN			17.0	8A				800	8 H	10K			22	16								
G807	BEA	SIN	S16	H	6.3	900	750			120	30.0	600	275	90	100	6.5					12.0	7.0	60	5AW
G811	TRI	SIN			6.3	400				50.0	1K					160					5.6	5.5	100	T1S
G837	PND	SIN			12.6	700				200	500	200	85	30.0	34						16.0	10.0		
G889	TRI	SIN			11.0	125A				5 K	7K				21						23.3	3.0	100	
G891	TRI	SIN			11.0	60A				K3.5	8K				8									
GKE1000	TET	SIN			17.0	18A				H7.5	4K	500			30	150					22.0	0.2		
G1625	BEA	SIN			12.6	450				25.0	600				60						11.0	7.0		
GK2000	TRI	SIN			16.0	51A				1A	10 K	8K			70									
GK3000	TRI	SIN			17.0	18A				1600	1 K	10K			52	200								
GI-3100	TRI	SIN			6.3	1100				10.0	2K				22	16					2.6	1.1	300	
G40011	TRI	SIN			15.0	70A				3 H	4K				40	150					5.3	1.2		

GROUP IV, RECTIFIER TUBES

TYPE NUMBER	KIND	TYPE	BULB	GAS	CATHODE	E <sub>r</sub> v	I <sub>f</sub> ma	MAXIMUM		TYPICAL	
								E <sub>b</sub> v	I <sub>b</sub> ma	E <sub>b</sub> v	I <sub>b</sub> ma
GG-1-0.3/8	DIO	SIN	T14	AR	H	6.3	4A	8K	1A	30	□1
GG-1-0.5/20	DIO	SIN	T21	AR	H	6.3	5A	20K	3500	30	□1
GG-1-1/22	DIO	SIN	T30	GS	H	6.3	14A	22K	1A	30	1
GG-1-2/5	DIO	SIN	T22	XE	H	6.3	6500	9K	6500	16	2
GG-1-2/16	DIO	SIN	T30	AR	H	6.3	16A	16K	7A	30	2
GR-1-0.3/8.5	DIO	SIN	S21	AR	F	6.3	4A	8K	1A	30	□1
VO-1	DIO	SIN			H	4.0	3200			850	40
VI-00313	DIO	SIN	T10		F	2.5	4600	13K	3000		30
GR1-02/15	DIO	SIN	S16	HG	F	5.0	3300	□2K	800		235
VI-02/20	DIO	SIN	T13	VC	F	2.5	3200	20K	100		20
VI-03/13	DIO	SIN	T9	VC	F	2.5	4650	13K	3A		30
GG1-0.5/5	DIO	SIN	S21	KX	F	2.5	8500	5K	1500		500
VI-05/70	DIO	SIN	T32	VC	F	5.0	32A	70K	8A		50
VI-06/30	DIO	SIN						30K			60
VI-1/2.5	DIO	SIN	W12	VC	F	15.0	12A	25H	1000		
VI-1/30	DIO	SIN	T18	VC	F	5.0	5A	30K	600		100
VI-1/40	DIO	SIN	T17	VC	F	5.0	6A	40K	750		100
VI-2/40	DIO	SIN						40K			200
VI-3/16	DIO	SIN	A27	VC	H	6.3	10A	16K	1500		300
VI-3/70	DIO	SIN						70K			300
VI-4/40	DIO	SIN	G70	VC		7.5	48A	44K	2A		450
VI-1-5/20	DIO	SIN	T16	VC	H	6.3	29A	20K	5000		180
VI-15/95	DIO	SIN	T31	VC	F	6.3	7500	55K	700		125
GR-1-25/15	DWD	SIN	GS	F		5.0	3A	□2K	800	500	
VI-1-5/30	DIO	SIN	A16	VC	W	6.3	95A	30K	2000		500
VI-1-18/32	DIO	SIN	A23	VC	H	17.0	3700	40K	20A		300
VI-1-27/35	DIO	SIN	A40	VC	H	9.0	145A	35K	70A		30
VI-2-27/35	DIO	SIN	W20	VC	H	9.0	145A	35K	70A		30
VI-1-30/25	DIO	SIN				10.0	6A	25K	30A		30
VI-1-70/32	DIO	SIN						32K	70A		
VI-1-10050	DIO	SIN						50K	100A		
VG1/8500	DIO	SIN		GS	F	2.5	5500	8K	1A	6K	300
VI-2-70/32	DIO	SIN	A21	VC	H	12.6	5300	32K	70A		70
VI-2-100/50	DIO	SIN	A30	VC	H	12.6	36A	50K	100A		
2V6	DIO	ARC		HG	C			400	6A		

GROUP IV, RECTIFIER TUBES

TYPE NUMBER	KIND	TYPE	BULB	GAS	CATHODE	E <sub>r</sub> v	I <sub>f</sub> ma	MAXIMUM		TYPICAL	
								E <sub>b</sub> v	I <sub>b</sub> ma	E <sub>b</sub> v	I <sub>b</sub> ma
2V12	DIO	ARC		HG	C			1K	1A		
2V20	DIO	ARC		HG	C			750	20A		
2VN12	DIO	ARC		HG	C			450	12A		
2VN20	DIO	ARC		HG	C			750	20A		
3V30	DIO	ARC		HG	C			750	30A		
3VN30	DIO	ARC		HG	C			750	30A		
3VN60	DIO	ARC		HG	C			400	60A		
3VN100	DIO	ARC		HG	C			600	100A		
I-20/1500	DIO	IGN	W19	HG	C			1K	1KA		20A
I-50/1500	DIO	IGN	W26	HG	C			1K	2KA		50A
I-100/1000	DIO	IGN	W33	HG	C			1K	2KA		100A
I-100/5000	DIO	IGN	W33	HG	C			5K	300A		100A
VO-111D	DIO	SIN	S		F	4.0	1500	12K	400	160	80
VO-125	DIO	SIN			F	4.0	700			250	60
VG-129	DIO	SIN	S20	HG	F	2.5	9A	7K	1500		500
VG-161	DIO	SIN		HG	F	2.5	6A	□3K	1A	□2K	300
VG-163	DIO	SIN				5.0		15K	50A	18	
VG-176	DIO	SIN	G16		M	2.5	11A	150	9A	20	
VO-188	DWD	SIN			F	4.0	2A			500	155
VO-196	DIO	SIN			H	4.0	3A			750	250
VO-197	DWD	SIN			F	4.0	5A			250	300
IVS200/2	IGN	W		HG	C			□3K	450A	16	150
VO-202	DWD	SIN			F	4.0	700			250	60
VO-230	DIO	SIN			F	4.0	700			350	50
VG-236	DIO	SIN				2.5		7K	4A	16	
VG-237	DIO	SIN	G32		F	5.0	22A	10K	10A		3500
VO-239	DIO	SIN			F	4.0	2A			850	180
VG-252	DIO	SIN			F	2.5		300	30A	15	
VO-360	DIO	SIN			F	4.0	1A			500	100
T-409	DIO	IGN	G14	HG	C			3K	200A		3K
T-410	DIO	IGN	G17	HG	C			14K	20A		6K
T-411	DIO	IGN	G17	HG	C			19K	100A		8K
1502	DIO	SIN	F13		H	5.0	3000	□2K	1200	500	400

GROUP V, VOLTAGE REGULATOR TUBES											
TYPE NUMBER	KIND	GAS		CATH	VOLT. RANGE		CUR. RANGE		DIMEN		BASE
		KIND	PRES	MAT'L	MAX	MIN	MAX	MIN	DIA.	LTH	
			mm		v	v	ma	ma	mm	mm	
SG1P	REG	AHE			190	145	30	5	22	65	7DN
SG1P-V	REG				170	145	30	5	22	65	7DN
SG1P-YE	REG				170	143	30	5	22	65	7DN
SG2P	REG	AKN			150	104	30	5	22	65	7DN
SG2S	REG	NA	30		110	70	40	5	32	75	4AJ
SG3P	REG	AHE			170	144	40	5	22	65	
SG3S	REG	AHN	30		133	105	40	5	32	75	4AJ
SG4S	REG	AHE	30	NI	180	145	30	5	32	75	4AJ
SG5B	REG	AHE			190	142	10	5	10	36	
SG5B-V	REG				170	142	10	5	10	36	
SG7S	REG				480	390	0.1	0.003			
SG8S	REG				970	880	0.1	0.003	10		
SG9S	REG				13H	12H	0.1	0.01	10		
SG10S	REG	NK			150	86	15	4	32	40	
SG13P	REG	AHN	55	NI	180	143	30	5	19	55	7DN
SG15P	REG	AHN	54	MO	150	104	30	5	19	55	7DN
SG16P	REG	NA	40	MO	130	80	30	5	19	55	7DN
SG17S	REG	NEH			1350	850	60	10	38	189	
SG18S	REG	NEH			1500	950	60	10	38	189	
SG19S	REG	NEH			1650	1050	60	10	38	189	
SG201S	REG	NK	50	MO	150	86	15	4	32	40	7DN
SG202B	REG	NA	35	MO	140	81	5	1.5	10	40	
SG226	REG	NE			95	70	40	8	50	130	
SG227	REG	NE			95	70	60	10	65	135	
SG301S	REG	HY	16	NI	439	380	0.1	0.003	12	55	
SG302S	REG	HY	82	NI	970	880	0.1	0.003	12	55	
SG303S	REG	HY	143	NI	1350	1220	0.1	0.01	12	55	
SG304S	REG	HY			4200	3800	1	0.05	25	129	
SG305K	REG				10K	9K	1.5	0.05	33	180	
SG306K	REG				26K	24K	1.5	0.05	48	245	

GROUP VI, CURRENT REGULATOR TUBES									
TYPE NUMBER	KIND	TYPE	BULB	VOLT. RANGE		CUR. RANGE		BASE	
				MAX	MIN	MAX	MIN		
				v	v	ma	ma		
24B12-18	BAL	SIN	T10	18	12		255		
3B17-35	BAL	SIN	T14	35	17		300	8ES	
3B65-135	BAL	SIN	T14	135	65		300	8ES	
425B55-12	BAL	SIN		12	06	460	425	8ES	
85B55-12	BAL	SIN	T9	12	06	920	780	8ES	
1B5-9	BAL	SIN	T14	9	5		1000	DS5	
1B10-17	BAL	SIN	T14	17	10		1000	DS5	
ST2S	BAL	TWN		17	6		2000	DS6	
ST3P	BAL	SIN	T6	6	4	880	720		



GROUP VII, THYRATRONS

TYPE NUMBER	KIND	BULB		GAS		CATHODE			MAXIMUM ANODE			AVG		MAXIMUM GRID			BASE		
		SHARE	LTH	DIAM	mm	E <sub>f</sub>	I <sub>f</sub>	WARM-UP MIN. SEC.	PIV	E <sub>f</sub>	FIRING TUBE DROP	I <sub>b</sub>	I <sub>b</sub>	BIAS	INPUT RES	IGN. TIME		PULSE	LTH
			mm	mm		v	ma		v	v	v	ma	ma	v	KΩ	μs	ns	ms	
I-1-70/0.8	IGN W		290	142	HG C	800			200	25	70A								
I-1-100/1.5	IGN W		360	157	HG C	15H			200	3HA	1HA								
I-1-140/0.8	IGN W		318	168	HG C	800			200	30	1HA								
I-1-350/0.8	IGN W		455	210	HG C	800			200	35	3HA								
I-2-50/1.5	IGN W		360	157	HG C	15H					1HA	50A							
I-20/1.5	IGN W		220	76	HG C	15H			175	15	60A	20A							
I-50/1.5	IGN W		260	105	HG C	15H			175	15	1HA	50A							
I-100/1.0	IGN W		380	210	HG C	1K			175	20	6HA	1HA							
I-100/5.0	IGN W		650	370	HG C	5K			200	20	3HA	1HA							
I-150/1.0	IGN W		495	160	HG C	1K			175	20	1HA	1HA							
I-200/1.5	IGN W		450	197	HG C	15H			150		6HA	2HA							
TG1B	TRI T		36	10	KX H	6.3	225	10	240	240	30	20	120	20	100	1M	100	30	10
TG1B-V	TRI T		36	10	KX H	6.3	225		240			16	120	20	28				
TG1-0.02/0.5	TET T		38	19	XE H	6.3	150	10	500	500	30	16	120	20	15	10M	15		8T1
TG1-0.1/0.3	TRI T		97	35	AR H	6.3	660	30	300	300		20	300	75	80	500	80	20	
TG1-0.1/1.3	TET T		105	39	KX H	6.3	600	10	1300	650	25	11	500	100	100	10M	100	5	60
TG1-0.5/12	TRI T		225	62	AR H	6.3	5A	120	12K	500	27	3A	500	70	100				10
TG1-1.0/0.8	TET T		130	61	KX H	6.3	300	60	800	420	50	15	600	1A	15	1M	15		10T
TG1-1.5/2	TRI T		160	68	XE H	6.3	7500		2K		16	5A	15H	15					
TG1-1.6/1.3	TRI T		201	66	XE H	5.0	6A	90	1300	1K	20	10A	2A	100	100	100			
TG1-2.5/4	TRI S		255	85	KX F	5.0	12A	60	4000	3K	140	20	8A	23A	100	100	100		4T2
TG1-2.5/10	TET T		285	90	XE H	5.0	15A		10K		16	8A	25H	50					
TG1-3.2/1.3	TRI T		222	66	XE H	5.0	8A	90	1300	1K	20	20A	3A	100	100	100			
TG1-5-3	TRI T		350	110	KX F	5.0	21A		3K		22	15A	5A	20					
TG1-6.4/1.3	TRI T		242	66	XE H	5.0	13A	120	1300	1K	20	40A	6A	100	100	100			
TG1-12.5/1	TRI T		292	90	XE H	5.0	16A		13H		20	80A	12A	20					
TG1-01/03	TRI T				AR H	6.3	660		300		20	300							
TG1-1B	TRI T		40	10	XE H	3.1	1500		500		20A								
TG1-1-3/1	TET T		67	19	AR H	6.3	1A	90	1000	1K	35	3A	6	40			12	300	5
TG1-1-10/1	TRI T		80	32	HY H	6.3	2600	60	1000	2K	20A	50	100	15			6	150	40
TG1-1-35/3	TRI T		135	38	HY H	6.3	2500	180	1500	3K	140	35A	45	100			6	500	
TG1-1-50/5	TRI T		160	45	HY H	6.3	3600	180	5K	5K	160	50A	50						4
TG1-1-90/8	TRI T		60	60	HY H	6.3	7000		8K		90A	100							2
TG1-1-130/8	TRI T		180	64	HY H	6.3	500		3K		1HA	150							2
TG1-1-130/10	TRI T		205	62	HY H	6.3	5A	240	10K	10K	150	1HA	250						4

GROUP VII, THYRATRONS

TYPE NUMBER	KIND	BULB		GAS	CATHODE		MAXIMUM ANODE				AVG	MAXIMUM GRID			BASE						
		SHAPE	LTH mm		DIAM mm	E <sub>f</sub> v	I <sub>f</sub> ma	WARM-UP MIN. SEC	PIV v	E <sub>f</sub> v		FIRING TUBE DROPS v	PULSE I <sub>b</sub> ma	BIAS RES KΩ		INPUT RES KΩ	PULSE				
																	IGN.	TIME	τ <sub>r</sub>	μs	ns
TG1-1-325/16	TRI	T	230	66	HY	H	6.3	8500				150	3HA	200	200	□1	1				
TG1-1-400/3.5	TRI	S	280	85	HY	H	5.0	18A	180	3500	1K		4HA	300	2	20					
TG1-1-400/16	TRI	T	268	78	HY	H	6.3	10A		16K			170	4HA	200	200	□1				
TG1-1-700/25	TRI	T	450	135	HY	H	6.3	20A		20K			200	7HA	700	700	□1				
TKH-1	TRI		85	34	NE	C					150		60	100	30						
TKHIB	TRI										160		85	30	10	10M	85				
TRI-5/2	TRI	T	275	90	HG	H	5.0	15A		2K			15	15A	500	24					
TRI-6/15	TRI	T	350	90	HG	H	5.0	23A	900	15K			18	20A	6A	100	5				
TRI-15/15	TRI	T	490	95	HG	H	5.0	40A		15K			20	47A	15A	100					
TRI-40/15	TRI	G	700	245	HG	H	5.0	68A	3K	15K			20	1HA	40A	100	5				
TRI-85/15	TRI	T	760	270	HG	H	5.0	130A		15K			20	3HA	85A	100					
TRI-130/15	TRI	T		220	HG	H	5.0	130A		15K				3HA	85A						
TG2-0.1/0.1	TRI	T	105	40	XE	H	6.3	600	10	100	100		11	300	100	2	5M				
TG2-0.5/12	TRI	T	225	62	HY	H	6.3	7A		12K			70	4A	500	100					
TG2.5/5	TRI					F	5.0	13A		3K				8A	2A	18					
TG1-2-260/12	TRI	T	285	90	HY	H	6.3	12A		12K					400	200					
TG1-2-325/16	TRI				HY	F	6.3	8500		16K				3HA	200						
TG1-2-400/35	TRI				HY	F	5.0	18A		3500				4HA	300						
TKH-2	TRI		50	19	HE	C				350			80	100	12						
TG3-0.1/1.3	TET	T	57	19	KX	H	6.3	600		1300	650	30	11	500	100	10M	100	10	60	10	7EM
TG3-2.5/13	TRI	T	290	90	KX	H	5.0	20A		10K			25	8A	43A	30					
TKH3B	TET	T	40	10	NA	C				190			110	5	2	20M	67	15	1		
LP-4	COM					H	4.0	270		260				1		70					
TKH4B	TET		40	10	NA	C				225			115	7	3	99M	92	10			
LP-5	COM					H	4.0	370		200				100		40					
TKH-5A	TRI		25	7	NA	C				270			110	41	41						
MTKH90	TRI		30	12	NE	C				160			50	20		20M	85				
TG1-200	TRI	S	280	85	KX	F	5.0	15A	60	3500			20	2HA		18	200				
TG212M	TRI	T	105	35	AR	H	4.0	950	30	300	300		27	500	125	7	100				
TG-213	TRI					F	2.5	9A						1A	500	15					
TG-235	TRI					F	5.0	12A						6A	1A	16					
T-409			121	45	HH	C								2HA	70		6				
T-410			146	53	AO	C								1HA	14		1				
T-411			151	53	AO	C								40A	53		4				

GROUP VIII, CATHODE RAY

TYPE NUMBER	METH. OF		DIMENSIONS		CATHODE	TYPICAL					MAXIMUM		SCREEN		DEFL ANGLE (degree)	BASE				
	FOCUS	DEFL	DIAM	LENGTH		USE	HEATER		E <sub>Foc</sub>	E <sub>A1</sub>	E <sub>A2</sub>	E <sub>A3</sub>	E <sub>A4</sub>	E <sub>C1</sub>			I <sub>k</sub>	DEFL SENS	COL	PERS
							E	I												
L1-1			4	17	IC	H	6.3	510	400	1.2				50				F8		
L1-3	ELM	ELM	1	1C	H	12.6	300	650	1.0					50				A4		
P1M-3			6	1C				18.0								V	B			
P1M-4			13	1C				18.0								V	B			
L1-6	ELM	ELM	2	32	1C	H	12.6	300	850	1.3				50				A4		
L1-7	ELM	ELM	2	32	1C	H	12.6	300	850	1.3				50				A4		
L1-13	ELM	ELM	3	39	1M	H	6.3	600	285	0.6	0.9			35				C14		
L1-14	ELM	ELM	3	39	1M	H		270	0.6	0.9				35				C14		
L1-15	ELM	ELM	3	39	1M	H	6.3	600	285	0.6	0.9			35				C14		
L1-17	ELM	ELM	3	39	1M	H	6.3	600	285	0.6	0.9			35				C14		
L1-18	ELM	ELM	2	16	V1	H	6.3	450	600				80	1				B9		
L1-23	ELM	ELM	34	16			6.3	600	300	0.3			125							
L1-101	ELM		15	1C	H	13.6	300	800	1.2				5							
L1-201	ELM		15	1M	H	6.3	600	15H	0.4											
L1-203	ELM	ELM	77	39			6.3	600	270	1.5										
L1-401	ELM	ELM	34	16			6.3	450					150							
3L01-1	ELS	ELS	3	12			6.3	600	100				60	300	0.18	GR	MD			
5L0381	ELS	ELS	5	19	OS	H	6.3	600	300	0.5	1.0		60	1M	0.11	BL	MD	11L		
6LK18	ELM	ELM	6	27	PR	H	6.3	600		25.0			60	200		WH	SH			
7L01M	ELS	ELS	7	19	OS	H	6.3	600	235	1.4	2.8		76			PB	SH	A12		
7L0551	ELS	ELS	7	19	OS	H	6.3	600	180	1.1	2.0		76		0.12	BL	MD	A12		
8LM3V	ELS	ELS	8	21	OS	H	6.3	600	400	0.7	4.0		50			WH	LO	A7		
8L0291	ELS	ELS	8	26	OS	H	6.3	600	350	1.1	1.5		45		0.17	GR	MD	14G		
8L029M	ELS	ELS	8	26	OS	H	6.3	600	350	1.1	1.5		45		0.17	PB	SH	14G		
8L0301	ELS	ELS	8	27	OS	H	6.3	600	400	1.1	1.5		45		0.17	GR	MD	14J		
8L030M	ELS	ELS	8	27	OS	H	6.3	600	400	1.1	1.5		45			PB	SH	14J		
8L039V	ELM	ELM	8	27	OS	H	6.3	600	400	2.0	4.0		60		0.28	WH	LO	14J		
10LK28	ELM	ELM	8	32	PR	H	1.5	3K	20.0				120			WH	MD	G8		
10L0431	ELS	ELS	10	41	OD	H	6.3	600	550	1.0	2.5		60		0.20	GR	MD	A25		
13L0101M	ELS	ELS	12	32			6.3	600	1K				125			BL	SH			
13L0102M	ELS	ELS	13	61			6.3	750	1K				300			BL	SH			
13LK1B	ELM	ELM	12	37	TV	H	6.3	550		7.0			76			WH	MD	D8		
13LK2B	ELM	ELM	8	31	TV	H	6.3	500		4.0			25			WH	SH	A9		
13LM4V	ELM	ELM	13	29	OS	H	6.3	600		0.4	12.0		50			WH	LO	AB		
13LM31M	ELM	ELM	11	28	OS	H	6.3	600	250	6.0			70			YO	LO	AB		

GROUP VIII, CATHODE RAY

TYPE NUMBER	METH. OF		DIMENSIONS		CATHODE		TYPICAL							MAXIMUM			SCREEN		DEFL ANGLE		BASE
	FOCUS	DEFL	DIAM	LENGTH	USE	HEATER		E <sub>Foc</sub>	E <sub>A1</sub>	E <sub>A2</sub>	E <sub>A3</sub>	E <sub>A4</sub>	E <sub>C1</sub>	I <sub>k</sub>	DEFL SENS	COL	PERS	DEFL ANGLE			
						E <sub>v</sub>	I <sub>ma</sub>												Kv	Kv	
13LM31V	ELM	ELM	13	29	OS	H	6.3	600	0.2	4.0			50			WH	LO	AB			
13LM56I	ELS	ELM	13	29	OS	H	6.3	600	0.7	4.0			50			GR	MD	AB			
13LM57	ELM	ELM	11	28	OS	H	6.3	600	250	6.0			71			GR	LO	AB			
13LM57D	ELS	ELM	13	29	OS	H	6.3	600	0.7	4.0			50			PB	LO	AB			
13LM58K	ELS	ELM	13	29	OS	H	6.3	600	0.7	4.0			50			RD	LO	AB			
13LO18	ELS	ELS	13				2.5	2A	425	2.0			40			GR	MD				
13LO28	ELS	ELS	13				6.3	600	500	1.8	3.0		50			GR	MD	14J			
13LO31	ELS	ELS	14	43	OS	H	6.3	600	410	1.5	3.0		50					A14			
13LO41	ELS	ELS	14	43	OS	H	6.3	600	425	1.5	5.0	8.0	50					A14			
13LO5P	ELS	ELS	13				6.3	600	500	1.8	3.0		50			YO	LO	14J			
13LO6P	ELM	ELM	13				6.3	600	250	6.0			45			YO	LO	AB			
13LO36	ELS	ELS	11	42	OS	H	6.3	600	690	2.0	4.0		60			YO	LO	14J			
13LO36V	ELS	ELS	14	43	OS	H	6.3	600	525	1.1	2.0	4.0	60					14J			
13LO37A	ELS	ELS	14	43	OS	H	6.3	600	400	1.1	1.5	3.0	50					14J			
13LO37I	ELS	ELS	14	43	OS	H	6.3	600	400	1.1	1.5	3.0	50					14J			
13LO37M	ELS	ELS	14	43	OS	H	6.3	600	400	1.1	1.5	3.0	50					14J			
13LO48A	ELS	ELS	14	41	OD	H	6.3	600	400	1.2	1.5		60					A14			
13LO48I	ELS	ELS	14	41	OD	H	6.3	600	400	1.2	1.5		60					A14			
13LO48M	ELS	ELS	14	41	OD	H	6.3	600	400	1.2	1.5		60					A14			
13LO54A	ELS	ELS	14	43	OS	H	6.3	600	300	1.1	1.5	3.5	6.0	750				B14			
13LO54M	ELS	ELS	14	43	OS	H	6.3	600	300	1.1	1.5	3.5	6.0	750				B14			
13LO54V	ELS	ELS	14	43	OS	H	6.3	600	700	1.1	1.5	3.5	6.0	750				B14			
13LO104A	ELM	ELM	13	54		H	6.3	600	700	.4	.8	1.2	1.8	100				D14			
18LK28	ELM	ELM	14	42	TV	H	6.3	550		15.0			30			WH	SH	D8			
18LK3V	ELM	ELM	18				2.5	2A	3.5				60			GR	MD				
18LK48	ELS	ELM	17	34	TV	H	6.3	600	6.0				60			WH	SH	B8			
18LK58	ELM	ELM	17	35	TV	H	6.3	520	4.0				30			WH	SH	B8			
18LK78	ELM	ELM	17	35	TV	H	6.3	560	4.0				35			WH	SH	B8			
18LK15	ELM	ELM	17	34	TV	H	6.3	550	5.0				38			WH	MD	B8			
18LM35	ELM	ELM	15	34	OS	H	6.3	600	250	6.0			48			YO	LO				
18LM35V	ELM	ELM	18	35	OS	H	6.3	600	4.0				50			WH	LO	AB			
18LO1P	ELM	ELM	18	47			6.3	600	250	6.0			45			YO	LO	AB			
18LO408	ELS	ELS	18	36	TV	H	6.3	600	2.0				120			WH	MD	14G			
18LO47A	ELS	ELS	18	45	OD	H	6.3	600	1.0	2.0	6.0		100					A25			
18LO47V	ELS	ELS	18	45	OD	H	6.3	600	1.0	2.0	6.0		100					A25			



GROUP VIII, CATHODE RAY

TYPE NUMBER	METH. OF FOCUS		DIMENSIONS		CATHODE	TYPICAL			MAXIMUM			SCREEN COL PERS	DEFL ANGLE degree	BASE		
	DEFLECTOR	USE	DIAM cm	LENGTH cm		E <sub>Foc</sub> v	E <sub>A1</sub> Kv	E <sub>A2</sub> Kv	E <sub>A3</sub> Kv	E <sub>A4</sub> Kv	E <sub>C1</sub> v				I <sub>k</sub> μo	DEFLECT SENS mm/v
19LK4B	ELM	ELM	17		TV	H	6.3	600	6.0							
20LM1YE	ELS	ELM	20	46			6.3	12H 750	8.0				300	GR	LO	
23LK1B	ELM	ELM	19	38	TV	H	6.3	550	10.0				100	WH	MD	
23LK2B	ELM	ELM	22	47	TV	H	6.3	550						WH	SH	
23LK7B	ELM	ELM	S18	40	TV	H	6.3	520	8.0					WH	SH	
23LK8B	ELM	ELM	S16	49	TV	H	6.3	550	15.0				100	WH	SH	
23LM34	ELM	ELM	19	43	OS	H	6.3	600 250	6.0					YO	LO	
23LM34V	ELM	ELM	23	46	OS	H	6.3	600	4.0					WH	LO	
23LO51A	ELS	ELS	23	57	OS	H	6.3	600	6.6	20.0			0.03	BL	SH	
30LK1B			30	45	TV	H	6.3	600	10.0				75		A20	
31LK1B	ELM	ELM	31		TV	H	6.3	550	10.0					WH	MD	
31LK2B	ELM	ELM	30	47	TV	H	6.3	600	10.0				150	WH	SH	
31LM32	ELM	ELM	25	51	OS	H	6.3	600 250	6.0				150	YO	LO	
31LM32V	ELM	ELM	31	54	OS	H	6.3	600	4.0					WH	LO	
31LO1P	ELM	ELM	31				6.3	600	1.8					GR	MD	
31LO33	ELS	ELS	25	56	OS	H	6.3	600 1K	4.3	5.5				YO	LO	
31LO33V	ELS	ELS	31	57	OS	H	6.3	600	1.1	4.3				WH	LO	
35LK2B	ELS	ELM	35	46	TV	H	6.3	600 300	0.5	12.0			150	WH	SH	
40LK1B	ELM	ELM	40	49	TV	H	6.3	550	12.0				70	WH	MD	
42LM2YE	ELS	ELM	42	59			6.3	12H 4K					100	GR	LO	
43LK2B	ELS	ELM	S45	50	TV	H	6.3	600	0.3	0.3	14.0			WH	SH	
43LK3B	ELS	ELM	S43	51	TV	H	6.3	600	0.5	14.0			150	WH	SH	
43LK6B	ELS	ELM	S45	30	TV	H	6.3	600	0.3	0.5	14.0			WH	SH	
43LK7B	ELS	ELM	S45	50	TV	H	6.3	600	0.3	0.3	14.0			WH	SH	
43LK8B	ELS	ELM	S45	50	TV	H	6.3	600	0.3	0.5	14.0			WH	SH	
45LM1B	ELM	ELM	40	56			6.3	600						WH	SH	
53LK2B	ELS	ELM	S53	61	TV	H	6.3	600	0.5	16.0			150	WH	SH	
53LK3B			S50	58	TV	H	6.3	600 300	0.4	16.0				WH	SH	
53LK4TS	ELS	ELM	S47	65			6.3	42A	25.0					3C		
53LK5B	ELS	ELM	S45	38	TV	H	6.3	600	0.3	0.5	16.0			WH	SH	

GROUP IX, MICROWAVE TUBES

TYPE NUMBER	KIND	FREQ		DUTY		CATHODE			MAXIMUM						COUPLING		DIMEN		WT. g					
		MIN	MAX	CYL	%	E <sub>f</sub>	I <sub>f</sub>	E <sub>b</sub>	I <sub>b</sub>	P <sub>o</sub>	COL.	E <sub>g</sub>	HELI	GAIN	NF	VSWR	BAND	MAG.		FIELD	GAUSS	LTH	DIAM	
		Gc	Gc			v	ma	v	ma	mw	v	v	v	v	db	db					mm	mm		
2J55	MAG		13.3	1	P			12K	12A	53K								3350						
3J21	MAG		24.5		P			15K	15	60K								1400						
4J26-30	MAG		1.2	1	P			27K	46A	700K														
4J45	MAG		2.8	1	P			23K	45	650K														
4J50	MAG		12.1	1	P			22K	27A	28K								6900						
UV-5	TWT	3.4	4.4			3.0	900	180	1	1000	600	12	500	18	10	1.6					WG 388	33	83	
UV-6	TWT	3.4	4.4			4.0	950	500	5	30	13H	30	11H	30		1.6					WG 388	33	95	
UV-7	TWT	3.4	4.4			6.3	850		35	3000	16H	50	14H	26		1.6					WG 397	33	100	
K42	KLY	0.9	1.5																					
K48	KLY	3.4	5.0																					
LO-247	TWT					4.0	700	800	160U							112	16							
410R	KLY																							
700AD	MAG		0.6	20	P			12K	10A	40K								650						
706AU	MAG		3.1		P			22K	20	200K														
707A/B	KLY	2.4	3.5		C	6.3		250		100	275							20						
714AU	MAG		3.3	1	P			19K	20A	165K								2250						
720AYE	MAG		2.8	1	P			27K	65A	1M								2900						
723A/B	KLY	8.5	9.6		C	6.3		300	20	30	300							70						
725A	MAG		9.3		P			12K	10	44K														
726	KLY	2.9	3.2		C	6.3		300	20	170	300							30						

GROUP X, TRANSISTORS

TYPE NUMBER	KIND	MAXIMUM						TYPICAL			MAXIMUM				MINIMUM		TYP. MIN			FIG						
		V <sub>CB0</sub> v	V <sub>EB0</sub> v	V <sub>CE0</sub> v	I <sub>C</sub> ma	I <sub>E</sub> ma	I <sub>CB0</sub> μa	P <sub>C</sub> mw	K <sub>θ</sub> jmw/°C	T <sub>j</sub> °C	h <sub>FE</sub>	V <sub>C</sub> v	I <sub>mo</sub>	h <sub>11</sub> Ω	h <sub>12</sub> 10 <sup>-5</sup>	h <sub>22</sub> μmho	h <sub>21</sub>	f <sub>α</sub> mc	*f <sub>MAX</sub> mc	NF db	K <sub>M</sub> db	C <sub>ob</sub> pf	r <sub>b</sub> Ω	r <sub>c</sub> Ω	C <sub>c</sub>	
P1A	GAP	20			5	5	30	50	10	70	E	10	1		3.3	0.90	0.1	0.1	35	30						1
P1B	GAP	20			5	5	30	50	10	70	E	10	1		2.0	0.93	0.1	0.1	35	33						400
P1D	GAP	20			5	5	15	50	10	70	E	10	1		2.0	0.94	0.1	0.1	18	33						600
P1G	GAP	20			5	5	30	50	10	70	E	10	1		2.0	0.96	0.1	0.1	37							600
P1I	GAP	20			5	5	20	50	10	70	E	10	1		2.0	0.96	1.6	35					40			1
P1V	GAP	20			5	5	15	50	10	70	E	10	1		1.0	0.93	0.1	35	37							400
P1YE	GAP	20			5	5	30	50	10	70	E	10	1		2.0	0.95	0.5	35	30				60	1K		1
P1ZH	GAP	20			5	5	20	50	10	70	E	10	1		3.3	0.95	0.1	35	35				45	1K		1
S1A	GPP	40			10	10		100			E	20	01			1.0	0.5		19							15
S1B	GPP	40			6	10		50			E	20	01			1.2	0.5		22							15
S1D	GPP	40			6	10		50			E	20	01			1.2	5.0		22							15
S1G	GPP	40			6	10		50			E	20	01			1.2	1.5		22							15
S1V	GPP	40			10	10		100			E	20	01			1.2	1.5		19							15
S1YE	GPP	40			6	10		50			E	20	01			1.2			15							15
P2A	GAP	100			10	10	200	250	10	60	C	50	5		0.90	0.90			17							1
P2B	GAP	50			25	25	200	250	10	60	C	25	10		0.90	0.90			17							1
S2A	GPP	30			10	10		100			E	10	01			1.2	0.5									15
S2B	GPP	20			6	10		50			E	10	01			1.5	1.5									15
S2G	GPP	20			6	10		50			E	10	01			1.5										15
S2V	GPP	20			6	10		50			E	10	01			1.5	5.0									15
P3A	GAP	50			50	150		500	S 3W	100	50	C	10	150	2.0	2.0	0.1		17							10
P3B	GAP	50			50	250		250	S 3W	100	50	C	10	150	2.0	2.0	0.1		20							10
P3V	GAP	50			50	450		250	S 3W	100	50	C	10	150	2.0	2.0	0.1		25							10
S3A	GPP	40			10	10		100			E	20	01			1.0	0.5		19							16
S3B	GPP	40			6	10		50			E	20	01			1.2	0.5		22							16
S3D	GPP	40			6	10		50			E	20	01			1.2	5.0									16
S3G	GPP	40			6	10		50			E	20	01			1.2	1.5		22							16
S3V	GPP	40			10	10		100			E	20	01			1.2	1.5		19							16
S3YE	GPP	40			6	10		50			E	20	01			1.2	10.0		15							16
P4	G	55			2A			10W																		
P4A	GAP	60			50	30	5A	500	30W	500	90	C	5A	5.0	5.0	0.1		20								7
P4B	GAP	70			60	30	5A	400	25W	500	90	C	5A	15	15	0.1		23								7
P4D	GAP	60			50	30	5A	400	25W	500	90	C	5A	50	30	0.1		20								7
P4G	GAP	60			50	30	5A	400	25W	500	90	C	5A	15	15	0.1		27								7
P4L	GAP	50			3A			500	25W	500	50	C	2A	20	20	0.1		30								7

GROUP X, TRANSISTORS

TYPE NUMBER	KIND	MAXIMUM										TYPICAL				MAXIMUM				MINIMUM		TYP. MIN			MAXIMUM			FIG
		V <sub>CE0</sub> v	V <sub>EBO</sub> v	V <sub>CEO</sub> v	I <sub>C</sub> ma	I <sub>E</sub> ma	I <sub>CBO</sub> μa	P <sub>C</sub> mw	K <sub>θ</sub> mw/°c	T <sub>j</sub> °c	COMMON	V <sub>C</sub> v	I ma	h <sub>11</sub> Ω	h <sub>12</sub> 10 <sup>-5</sup>	h <sub>22</sub> μmho	h <sub>21</sub>	f <sub>a</sub> * f MAX mc	NF db	K <sub>M</sub> db	C <sub>ob</sub> pf	r <sub>b</sub> Ω	r <sub>c</sub> Ω	r <sub>b</sub> Ω				
P4V	GAP	40	35	20	5A	6 10	400	25W	500	90	C	5A	10	10	10	0.1	23								7			
S4A	GPP	30	20		6 10		100		E	10	□1				1.2										16			
S4B	GPP	20	20		6 10		50		E	10	□1				1.5										16			
S4G	GPP	20	20		6 10		50		E	10	□1				1.5	10.0									16			
S4V	GPP	20	20		6 10		50		E	10	□1				1.5	5.0									16			
P5A	GAP	10	20	10	10 10	10 10	30	25	1	75	E	2	1	36	500	3.3	0.93	0.3	12						2			
P5B	GAP	10	20	10	10 10	10 10	15	25	1	75	E	2	1	36	500	2.6	0.95	0.3	12						2			
P5D	GAP	10	20	10	10 10	10 10	30	25	1	75	E	2	1	36	500	2.6	0.95	0.3	7						2			
P5G	GAP	10	20	10	10 10	10 10	30	25	1	75	E	2	1	36	500	2.6	0.97	0.3	10						2			
P5V	GAP	10	20	10	10 10	10 10	15	25	1	75	E	2	1	36	500	2.6	0.97	0.3	15						2			
P5YE	GAP	10	20	10	10 10	10 10	15	25	1	75	E	2	1	36	500	2.6	0.96	0.3	18						2			
P6A	GAP	30	30	10	10 10	10 10	30	150	2	100	E	5	1	32	500	3.3	0.90	0.1	30	30					3			
P6B	GAP	30	30	15	10 10	10 10	15	150	2	100	E	5	1	32	60	2.0	0.90	0.5	30	34					3			
P6D	GAP	30	30	15	10 10	10 10	15	150	2	100	E	5	1	32	60	2.0	0.90	0.5	12	34					3			
P6G	GAP	30	30	10	10 10	10 10	15	150	2	100	E	5	1	32	60	3.3	0.97	1.0	30	37					3			
P6V	GAP	30	30	15	10 10	10 10	15	150	2	100	E	5	1	32	60	2.0	0.94	0.5	30	34					3			
P7	GAP	13	20	10	45	10 10	30	45	50	50	E	2	1				0.97								2			
P8	GAN	20	20	10	10 10	10 10	30	150	2	100	E	5	1	34	500	3.3	0.90	0.1	15	32					3			
P8A	GAN																								3			
P9	GAN	20	20	15	10 10	10 10	15	150	2	100	E	5	1	32	60	2.0	0.90	0.5	12	32					3			
P9A	GAN	20	20	15	10 10	10 10	15	150	2	100	E	5	1	32	60	2.0	0.92	0.5	5	32					3			
P10	GAN	20	20	15	10 10	10 10	15	150	2	100	E	5	1	32	60	3.3	0.95	1.0	5	32					3			
P11	GAN	20	20	10	10 10	10 10	15	150	2	100	E	5	1	32	60	3.3	0.95	1.6	5	32					3			
P12	GAP	6	6	5	5	5	6	30	2	85	E	6	1				0.95	5.0							4			
P13	GAP	30	30	10	10 10	10 10	15	150	2	100	E	5	1	500	3.3	3.3	0.92	0.5	33						3			
P13A	GAP	30	30	10	10 10	10 10	15	150	2	100	E	5	1	60	2.0	2.0	0.97	0.5	33						3			
P13B	GAP	30	30	10	10 10	10 10	10	150	2	100	E	5	1	60	2.0	2.0	0.92	0.5	12						3			
P14	GAP	30	30	10	10 10	10 10	15	150	2	100	E	5	1	500	3.3	3.3	0.95	1.0	33						3			
P15	GAP	30	30	10	10 10	10 10	15	150	2	100	E	5	1	500	3.3	3.3	0.95	1.6	33						3			
P16	GAP	30	30	10	10 10	10 10	150	150	2	100						20	1.0								3			
P16A	GAP	30	30	10	10 10	10 10	150	150	2	100						30	1.0								3			
P16B	GAP	30	30	10	10 10	10 10	150	150	2	100						45	1.0								3			
P17	G P	60	60	400	400	400	200	300								9	0.2											
P17A	G P	60	60	400	400	400	200	300								16	0.2											
P17B	G P	60	60	400	400	400	200	300								32	0.2											



GROUP X, TRANSISTORS

TYPE NUMBER	KIND	MAXIMUM										TYPICAL				MINIMUM		TYP MIN		MAXIMUM		FIG	
		V <sub>CB0</sub> v	V <sub>EB0</sub> v	V <sub>CE0</sub> v	I <sub>c</sub> ma	I <sub>E</sub> ma	I <sub>CB0</sub> μo	P <sub>c</sub> mw	K <sub>θ</sub> mw/C	T <sub>j</sub> °c	COMMON	V <sub>c</sub> v	I ma	h <sub>11</sub> Ω	h <sub>12</sub> 10 <sup>-5</sup>	h <sub>22</sub> μmho	h <sub>21</sub>	f <sub>a</sub> *f <sub>mc</sub> MAX	NF db	K <sub>M</sub> db	C <sub>ob</sub> pf		r <sub>b</sub> r <sub>b</sub> °C
P18	G P	100		400	400	200	300									9	0.2						
P18A	G P	100		400	400	200	300									16	0.2						
P18B	G P	100		400	400	200	300									32	0.2						
P19	GAP	20	20	6	5	6	30	1	90	E	5	1	33		2.0	0.95	5.0	5			20	150	12
P20	GAP	50		50	1	50	150			C		25			50	1.0	1.0						3
P21	GAP	50		50	1	50	150			C		25			20	1.0	1.0						3
P21A	GAP	70		50	1	50	150			C		25			50	1.0	1.0						3
P25	GAP	60		400		600	200		70	E	20	2		3.5	10	0.2	0.2				70	500	3
P25A	GAP	60		400		600	200		5					3.5	20	0.2	0.2			20		500	3
P25B	GAP	60		400		660	200		5					3.5	30	0.5	0.5			20		500	3
P26	GAP	100		400		600	200		70	E	35	2		3.5	10	0.2	0.2				50	500	3
P26A	GAP	100		400		600	200		5					3.5	20	0.2	0.2			20		500	3
P26B	GAP	100		400		600	200		5					3.5	30	0.5	0.5			20		500	3
P27	GAP	5		5	6	3	30	1	70					2.0	20	1.0	1.0			10		50 *6K	20
P27A	GAP	5		5	6	3	30	1	70					1.0	20	1.0	1.0			5		50 *6K	20
P28	GAP	5		5	6	3	30	1	70					1.0	20	5.0	5.0			5		50 *6K	20
P29	GAP	12		10	100	4	30	1	70					25	25							20	21
P29A	GAP	12		10	100	4	30	1	70					45	45							20	21
P30	GAP	12		10	100	4	30	1	70					80	80							20	21
P101	SAN	10		10	20	20	70N	150	2	120	E	5	1	100	200	0.90	0.90			15		150	3
P101A	SAN	10		10	20	20	70N	150	2	120	E	5	1	100	200	0.90	0.90			15		150	3
P102	SAN	10		10	20	20	70N	150	2	120	E	5	1	100	500	0.93	0.93			15		150	3
P103	SAN	10		10	20	20	70N	150	2	120	E	5	1	100	500	0.90	0.90			15		150	3
P104	SAP	100	45	60	20	20	500N	150	2	150	E	5	1	140	3.3	0.90	0.90			10		80	1K
P105	SAP	45	45	30	20	20	500N	150	2	150	E	5	1	140	3.3	0.90	0.90			5		80	1K
P106	SAP	45	45	15	30	30	500N	150	2	150	E	5	1	80	2.0	0.93	0.93			5		80	□2K
P107	SAN	120				1	150							15	15	3	3						3
P135	GAP	30			10	10	150		100		5	1		60	2.0	0.92	0.92			12		50	3
P201	GAP	30	35	22	2A	400	1W	300	100					40	40	0.1	0.1			8			8
P201A	GAP	30	35	22	2A	400	1W	300	100					40	40	0.2	0.2			8			8
P202	GAP	55	35	30	2A	400	1W	300	100					20	20	0.2	0.2			8			8
P203	GAP	60	45	30	2A	400	1W	300	100					20	20	0.2	0.2			8			8
P207	GAP	45	20	40	25A	16M	4W	70	85					15	15	0.2	0.2			9			9
P207A	GAP	45	20	40	25A	16M	4W	70	85					15	15	0.2	0.2			9			9
P208	GAP	65	30	60	25A	25M	4W	70	85					15	15	0.2	0.2			9			9

GROUP X, TRANSISTORS

TYPE NUMBER	KIND	MAXIMUM										TYPICAL				MINIMUM				TYP		MIN		MAXIMUM		FIG
		V <sub>CB0</sub> v	V <sub>EB0</sub> v	V <sub>CE0</sub> v	I <sub>C</sub> ma	I <sub>E</sub> ma	I <sub>CB0</sub> μa	P <sub>C</sub> mw	K <sub>θ</sub> mw/°C	T <sub>j</sub> °C	COMMON	V <sub>C</sub> v	I ma	h <sub>11</sub> Ω	h <sub>12</sub> 10 <sup>-5</sup>	h <sub>22</sub> μmho	h <sub>21</sub>	*f <sub>m</sub> mc	f <sub>a</sub> mc	NF db	K <sub>M</sub> db	C <sub>ob</sub> pf	r <sub>b</sub> Ω	r <sub>c</sub> Ω	r <sub>e</sub> Ω	
P208A	GAP	65	30	60	25A		25M	4W	85							15										9
P209	P	45		#40	12A		8M	1500	43	85					15											13
P209A	P	45		#40	12A		8M	1500	43	85					15											13
P210	P	65		#60	12A		12M	1500	43	85					15											13
P210A	P	65		#60	12A		12M	1500	43	85					15											13
P302	SAP			35	1		100	8W	70	150							0.2									17
P303	SAP			60	1		100	10W	70	150							0.1									17
P303A	SAP			60	1		100	10W	70	150							0.1									17
P304	SAP			80	1		100	10W	70	150							0.1									17
P314A	GAP	10		1			10	100	85								0.94	30					15			
P314B	GAP	10		1			5	100	85								0.94	60					10			
P314C	GAP	10		1			5	100	85								0.94	120					6			
P322	GDP	8			15		2	50	85								0.97	400					4			
P401	GDP	20	20	10	10		10	100	2	85	E	5	5				0.94	30					15			3
P402	GDP	20	20	10	10		5	100	2	85	E	5	5				0.94	60					10			3
P403	GDP	20	20	10	10		5	100	2	85	E	5	5				0.94	*12	H				10			3
P403A	GDP	20	20	10	10		5	100	2	85	E	5	5				0.97	*12	H				10			3
P404	GSP	5	5	5	5		5	10	11	85	E	3	11				0.93	10					5			11
P404A	GSP	5	5	5	5		2	10	11	85	E	3	11				0.93	10					5			11
P405	GSP	5	5	5	5		5	10	11	85	E	3	11				0.95	30					5			11
P405A	GSP	5	5	5	5		2	10	11	85	E	3	11				0.95	30					5			11
P406	GAP			6	5	5	6	30	2	85		6	1				0.95	10					20	150	4	4
P407	GAP			6	5	5	6	30	2	85		6	1				0.95	20					20	150	4	4
P408	G P	20	20	6	5	5	6	30	1	90	E	5	1	33			0.95	10			5		20	150	12	5
P409	G P	20	20	6	5	5	6	30	1	90	E	5	1	33			0.95	20			5		20	150	12	5
P410	GDP	6	6	6	20		2	100	2	85	E	5	5	10	120		0.97	*20	H				4			6
P410A	GDP	6	6	6	20		2	100	2	85	E	5	5	10	120		0.99	*40	H				4			6
P411	GDP	6	6	6	20		2	100	2	85	E	5	5	10	120		0.97	400					4			6
P411A	GDP	6	6	6	20		2	100	2	85	E	5	5	10	120		0.99	400					4			6
P414	GDP	10			10		5	100	2	75							25	*60					10	*1K	3	3
P414A	GDP	10			10		5	100	2	75							50	*60					10	*1K	3	3
P414B	GDP	10			10		5	100	2	75							50	*60					10	*1K	3	3
P415	GDP	10			10		5	100	2	75							50	*12	H				10	*5K	3	3
P415A	GDP	10			10		5	100	2	75							50	*12	H				10	*5K	3	3
P415B	GDP	10			10		5	100	2	75							50	*12	H				10	*5K	3	3
P416	GDP			3	15	15	8	100	1	85							2.5						8	*5H	22	22
P416A	GDP			3	15	15	8	100	1	85							4.0						8	*5H	22	22

TYPE NUMBER		KIND		MAXIMUM										TYPICAL				MINIMUM			TYP MIN			MAXIMUM			FIG
				V <sub>CBO</sub> v	V <sub>EBO</sub> v	V <sub>CEO</sub> v	I <sub>C</sub> ma	I <sub>E</sub> ma	I <sub>CBO</sub> μa	P <sub>C</sub> mw	K <sub>θ</sub> mw/°C	T <sub>j</sub> °C	NONREC	V <sub>C</sub> v	I ma	h <sub>11</sub> Ω	h <sub>12</sub> 10 <sup>-5</sup>	h <sub>22</sub> μmha	h <sub>21</sub>	f <sub>α</sub> mc	NF db	K <sub>M</sub> db	C <sub>ob</sub> pf	r <sub>b</sub> r <sub>b</sub> r <sub>c</sub> r <sub>c</sub>			
P416B				3	15	15	8	100	1	85							4.0							8	*5H	22	
P416V				3	15	15	8	100	1	85							5.0							8	*5H	22	
P501				1	20		10	100	150	1	150	E	10	3			9							10		19	
P501A				1	20		10	100	150	1	150	E	10	3			19							10		19	
P502				1	20		10	100	150	1	150	E	10	3			9							10		19	
P502A				1	20		10	100	150	1	150	E	10	3			19							10		19	
P502B				1	20		10	100	150	1	150	E	10	3			9							10		19	
P502V				1	20		10	100	150	1	150	E	10	3			19							10		19	
P503				1	20		10	100	150	1	150	E	10	3			9							10		19	
P503A				1	20		10	100	150	1	150	E	10	3			19							10		19	
P601				25	25	1A		200	1W	85							20							10		14	
P601A				25	25	1A		100	1W	85							40							10		14	
P601B				25	25	1A		130	1W	85							80							10		14	
P602				25	25	1A		100	1W	85							40							10		14	
P602A				25	25	1A		130	1W	85							80							10		14	
P604A				15	45	200		400		50							10									18	
P604A				15	45	200		400		50							20									18	
P604B				15	45	200		400		50							40									18	

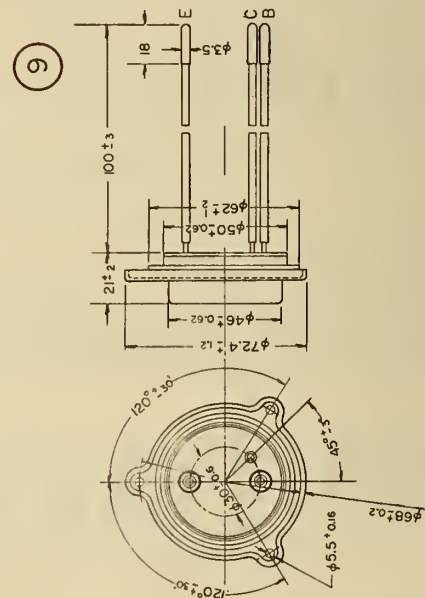
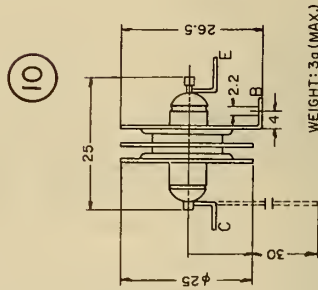
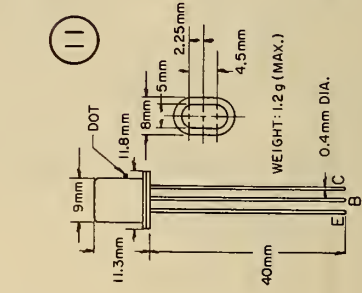
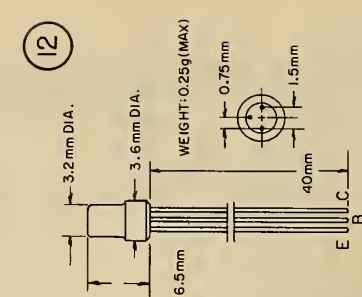
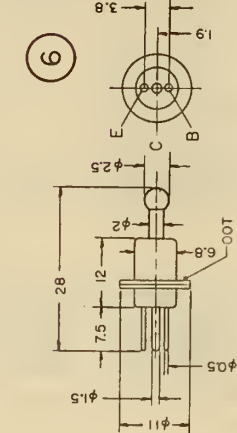
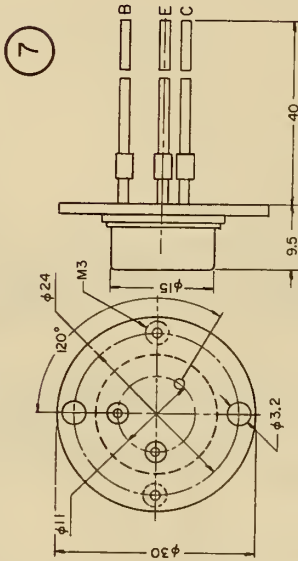
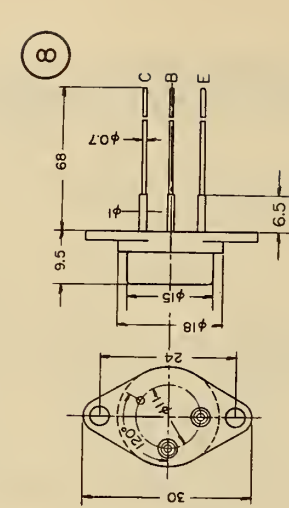
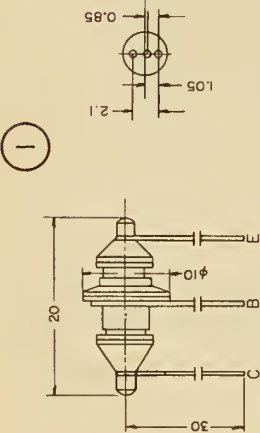
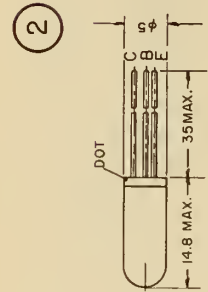
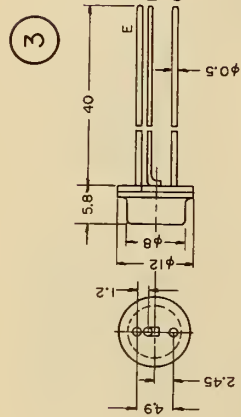
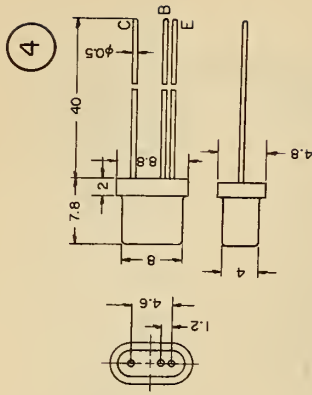

TRANSISTOR OUTLINE DRAWINGS  
GROUP X



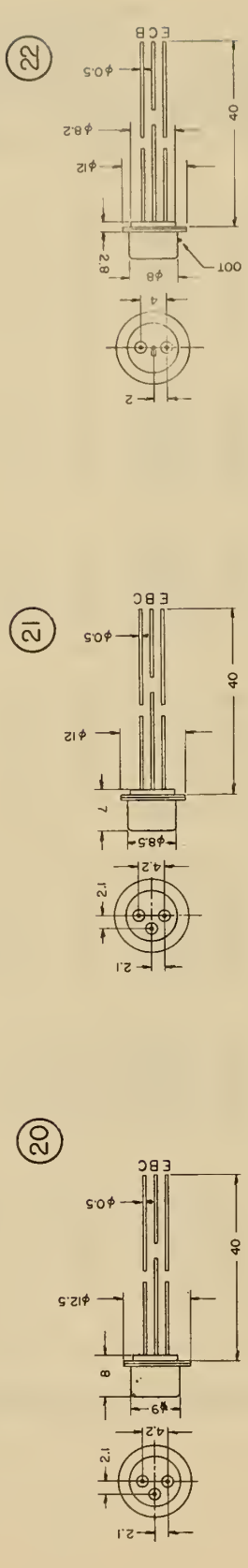
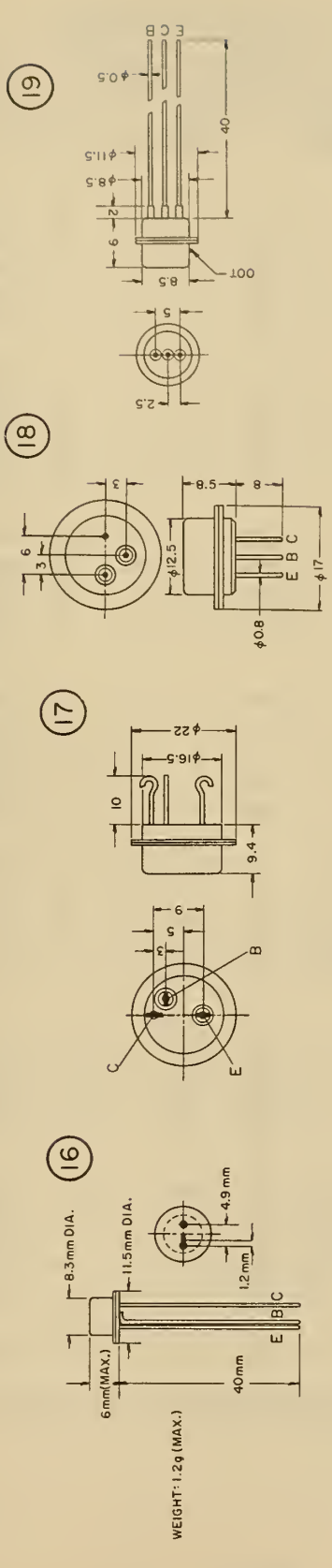
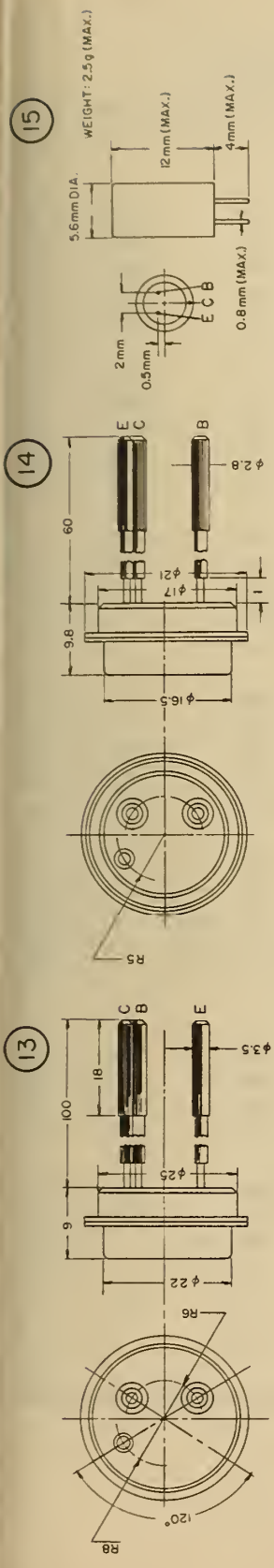

TRANSISTOR OUTLINE DRAWINGS  
(CON'T)

## GROUP XI, DIODES—RECTIFIERS

TYPE NUMBER	KIND	TYPE	MAXIMUM			MAXIMUM @ 25 °C			MAXIMUM			f <sub>Max</sub> mc	FIG
			I <sub>F</sub> @25°C ma	T <sub>Opr</sub> °C	I <sub>S</sub> @25°C A	PIV v	E <sub>F</sub> * MIN. E <sub>F</sub> v	I <sub>F</sub> ma	I <sub>R</sub> @ μa	E <sub>r</sub> @ v	T <sub>°C</sub>		
D1A	REC	GEP	16	70		40	1.0	2	250	10		150	1
D1B	REC	GEP	16	70		45	1.0	1	250	25		150	1
D1D	REC	GEP	16	70		110	1.0	2	250	75		150	1
D1G	REC	GEP	16	70		75	1.0	5	250	50		150	1
D1V	REC	GEP	25	70		45	1.0	8	250	25		150	1
D1YE	REC	GEP	12	70		150	1.0	1	250	100		150	1
D1ZH	REC	GEP	12	70		150	1.0	5	250	100		150	1
DG-TS1	REC	GEP	16	70	□1	50	*1.0	2	1000	50	20		2
D2A	@	REC	GEP	50	70		15	1.0	50	250	7	150	4
D2B	@	REC	GEP	16	70		45	1.0	10	250	10	150	4
D2D	@	REC	GEP	16	70		100	1.0	10	250	50	150	4
D2G	@	REC	GEP	16	70		100	1.0	5	250	50	150	4
D2K		REC	GEP	16	70		125	1.0	5	800	100		4
D2M		REC	GEP	16	70		125	1.0	5	250	100		4
D2N		REC	GEP	16	70		170	1.0	5	800	150		4
D2P		REC	GEP	16	70		180	1.0	5	250	150		4
D2R		REC	GEP	16	70		220	1.0	5	250	200		4
D2V	@	REC	GEP	25	70		60	1.0	10	250	30	150	4
D2YE	@	REC	GEP	16	70		150	1.0	10	250	100	150	4
D2ZH	@	REC	GEP	8	70		200	1.0	10	250	150	150	4
DG-TS2	REC	GEP	16	70	□1	75	*1.0	4	500	50	20		2
DG-TS3	REC	GEP	25			50	1.0	2	100	50	20		2
DG-TS4	REC	GEP	16	70	□1	100	*1.0	2	800	75	20		2
DG-TS5	REC	GEP	16	70	□1	100	*1.0	1	250	75	20		2
DG-TS6	REC	GEP	16	70	□1	125	*1.0	1	800	100	20		2
D7A	REC	GEP	300	70		50	0.5	300	300	50		50K	5
D7B	REC	GEP	300	70		100	0.5	300	300	100		50K	5
D7D	REC	GEP	100	70		300	0.5	300	300	300		50K	5
D7G	REC	GEP	300	70		200	0.5	300	300	200		50K	5
D7V	REC	GEP	300	70		150	0.5	300	300	150		50K	5
D7YE	REC	GEP	100	70	25	350	0.5	300	300	350		50K	5
D7ZH	REC	GEP	100	70	25	400	0.5	300	300	400		50K	5
DG-TS7	REC	GEP	16	70	□1	125	*1.0	1	250	100	20		2
DG-TS8	REC	GEP	25	70	□1	50	*1.0	10	500	30	20		2
D9A	REC	GEP	25	70		10	1.0	10	250	10		40	1
D9B	REC	GEP	40	70		10	1.0	90	250	10		40	1

## GROUP XI, DIODES—RECTIFIERS

TYPE NUMBER	KIND	TYPE	MAXIMUM			MAXIMUM @ 25 °C			MAXIMUM			f <sub>Max</sub> mc	FIG
			I <sub>F</sub> @25°C ma	T <sub>Opr</sub> °C	I <sub>S</sub> @25°C A	PIV v	E <sub>F</sub> * MIN. E <sub>F</sub> v	I <sub>F</sub> ma	I <sub>R</sub> μa	E <sub>r</sub> v	T <sub>°C</sub> °C		
D9D	REC	GEP	30	70		30	1.0	60	250	30		40	1
D9G	REC	GEP	25	70		30	1.0	30	250	30		40	1
D9I	REC	GEP	70	70		30	*1.0	30	500	30	70	40	1
D9K	REC	GEP	60	70		30	*1.0	60	400	30	70	40	1
D9L	REC	GEP	30	70		100	*1.0	30	250	100	70	40	1
D9V	REC	GEP	20	70		30	1.0	10	250	30		40	1
D9YE	REC	GEP	20	70		50	1.0	30	250	50		40	1
D9ZH	REC	GEP	15	70		100	1.0	10	250	100		40	1
DG-TS9	REC	GE	50	70	□1	45	*1.0	10	100	10	20		2
D10	REC	GEP	50	70		20	1.5	3	100	10	20	150	6
D10A	REC	GEP	50	70		20	1.5	5	200	10	20	150	6
D10B	REC	GEP	50	70		20	1.5	6	200	10	20	150	6
DGTS10	REC	GE	50	70	□1	45	*1.0	5	60	10	20		2
D11	REC	GEP	70	70		50	1.0	10	250	30		600	7
D12	REC	GEP	70	70		75	1.0	5	250	50		600	7
D12A	REC	GEP	70	70		75	1.0	10	250	50		600	7
DGTS12	REC	GEP	16	70		30	1.0						2
D13	REC	GEP	70	70		100	1.0	10	250	75		600	7
DGTS13	REC	GEP	16	70		30	1.0						2
D14	REC	GEP	70	70		125	1.0	3	250	100		600	7
D14A	REC	GEP	70	70		125	1.0	10	250	100		600	7
DGTS14	@	REC	16	70		50	1.0						2
DGTS15	@	REC	50	70	□1	170	*1.0	1	800	150	20		2
DGTS16	@	REC	50	70	□1	180	*1.0	1	250	150	20		2
DGTS17	@	REC	50	70	□1	220	*1.0	1	800	200	20		2
D21	@	REC	16	70		100	1.0	5	250	100	20	150	4
DGTS21	@	REC	300	70	25	75	*0.5	300	500	50	20		3
DGTS22	@	REC	300	70	25	150	*0.5	300	500	100	20		3
DGTS23	@	REC	300	70	25	225	*0.5	300	500	150	20		3
DGTS24	@	REC	300	70	25	300	*0.5	300	500	200	20		3
DGTS25	@	REC	100	70	25	450	*0.3	100	300	300	20		3
DGTS26	@	REC	100	70	25	525	*0.3	100	300	350	20		3
DGTS27	@	REC	100	70	25	600	*0.3	100	300	400	20		3
D101	REC	SIP	50	150		100	*2.0	2	100	100	125	200	6
D101A	REC	SIP	75	150		100	*1.0	1	75	100	125	200	6
D102	REC	SIP	50	150		75	2.0	2	100	75	125	200	6

GROUP XI, DIODES—RECTIFIERS

TYPE NUMBER	KIND	TYPE	MAXIMUM			MAXIMUM @ 25 °C			MAXIMUM			f <sub>Max</sub> mc	FIG
			I <sub>F</sub> @25°C ma	T <sub>Op</sub> °C	I <sub>S</sub> @25°C A	PIV v	E <sub>F</sub> * MIN. E <sub>F</sub> v	I <sub>F</sub> ma	I <sub>R</sub> @ μa	E <sub>r</sub> @T°C v	°C		
D102A	REC	S1P	75	150		75	1.0	1	100	75	125	200	6
D103	REC	S1P	50	150		30	2.0	2	100	30	125	200	6
D103A	REC	S1P	75	150		30	1.0	1	100	30	125	200	6
D104	REC	S1P	50	150		100	2.0	2	100	100	125		8
D104A	REC	S1P	75	150		100	1.0	1	75	100	125		8
D105	REC	S1P	50	150		75	2.0	2	100	75	125		8
D105A	REC	S1P	75	150		75	1.0	1	100	75	125		8
D106	REC	S1P	50	150		30	2.0	2	100	30	125		8
D106A	REC	S1P	75	150		30	1.0	1	100	30	125		8
D201A	REC	S1	200	125		25	1.5						
D201B	REC	S1	200	125		50	1.5						
D201D	REC	S1	400	125		100	2.0						
D201G	REC	S1	200	125		100	1.5						
D201TS	REC	S1	400	125		200	2.0						
D201V	REC	S1	400	125		50	2.0						
D201YE	REC	S1	200	125		200	2.0						
D201ZH	REC	S1	400	125		200	2.0	400	500	200			
D202	REC	S1A	400	150		100	1.5	400	500	100	125	0.1	9
D203	REC	S1A	400	150		200	1.5	400	500	200	125	0.1	9
D204	REC	S1A	400	150		300	1.5	400	500	300	125	0.1	9
D205	REC	S1A	400	150		400	1.5	400	500	400	125	0.1	9
D206	REC	S1A	100	125		100	1.0	100	100	100	125	0.1	10
D207	REC	S1A	100	125		200	1.0	100	100	200	125	0.1	10
D208	REC	S1A	100	125		300	1.0	100	100	300	125	0.1	10
D209	REC	S1A	100	125		400	1.0	100	100	400	125	0.1	10
D210	REC	S1A	100	125		500	1.0	100	100	500	125	0.1	10
D211	REC	S1A	100	125		600	1.0	100	100	600	125	0.1	10
D302	REC	GEA	1A	70		200	0.25	1A	1000	200	20	50K	11
D303	REC	GEA	3A	70		150	0.3	3A	1000	150	20	50K	11
D304	REC	GEA	5A	70		100	0.3	5A	3000	150	20	50K	11
D305	REC	GEA	10A	70		50	0.35	10A	3000	50	20	50K	11
D1001	REC	GE	100	80		2000	6.5	100	150	2000		□0.1	12
D1001A	REC	GE	100	80		1000	3.5	100	150	1000		□0.1	12
D1002	REC	GE	300	80		2000	7.5	300	300	2000		□0.1	13
D1002A	REC	GE	300	80		1000	4.0	300	300	1000		□0.1	13
D1003A	REC	GE	300	80		500	2.0	300	300	500		□0.1	12





**GROUP XIV, DIODES—MIXER & DETECTOR**

TYPE NUMBER	KIND	TYPE	MAXIMUM			FREQUENCY		MIN.	MAXIMUM					P <sub>BO</sub> # ergs # mW # v	FIG		
			Z <sub>V</sub> kΩ	T <sub>Opr</sub> °C	Z <sub>IF</sub> Ω	MIN G <sub>C</sub>	MAX G <sub>C</sub>	FM	NR	VSWR	NF db	LC db	POWER LEVEL mW				
DG-S1	MIX	GEP		70			3.1					3.5	3.0	8.5	800	0.1	15
DK-I1	MIX	SI		70			3.1									*200	17
DK-S1	MIX	SIP		70			3.1					3.0	2.7	8.5	800	0.1	17
DK-V1	DET	GE	15	70			3.1									*200	15
DL-S1	MIX	SIP		70			3.1					3.5	3.0	8.5	800	□0.1	
DG-S2	MIX	GEP		70			3.1					3.0	3.0	6.5	800	0.1	15
DK-I2	MIX	SI		70			9.4									*200	17
DK-S2	MIX	SIP		70			3.1					3.0	2.0	6.5	500	□0.1	17
DK-V2	DET	GE	10	70			3.1									*100	15
DL-S2	MIX	SIP		70			3.1					5.0	3.0	6.5	800	□0.1	
D3A	DET	SI		70								2.5				*300	15
D3B	DET	SI		70			3.1					2.5				*300	15
DG-S3	MIX	GEP		70			9.4					3.5	3.0	8.5	800	0.1	15
DK-S3	MIX	SIP		70			9.4					3.0	2.7	8.5	500	□0.1	17
DK-V3	DET	GE	15	70			9.4									*200	15
DL-S3	MIX	SIP		70			9.4					3.5	3.0	8.5	800	□0.1	
DG-S4	MIX	GEP		70			9.4					3.0	3.0	6.5	800	0.1	15
DK-S4	MIX	SIP		70			9.4					2.5	2.7	6.5		0.3	17
DK-V4	DET	GE	10	70			9.4									*100	15
DL-S4	MIX	SIP		70			9.4					3.0	3.0	6.5	800	□0.1	
DK-V5	DET	GE	10	70			3.1									*200	17
DK-V6	DET	GE	25	70			3.1									*200	17
DK-S7	MIX	SIP		70			9.4					2.0	2.0	7.0	500	□0.1	15
DK-V7	DET	GE	10	70			9.4									*200	17
D401	MOD	GE		50										13.0		*300	16
D403A	MIX	GE		100	700			3.0				3.0		9.0		0.3	15
D403B	MIX	GE		100	600	2.5		9.4				3.0		8.5		0.3	15
D403V	MIX	GE		100	600			3.0					13.0	9.0		0.3	15
D405	DET	SI			400			10.0						7.0	800	0.6	18
D405A	DET	SI			350			10.0						6.0	800	1.0	18
D405AP	DET	SI			350			10.0						6.0	800	1.0	18
D405B	DET	SI			330			10.0						8.0	800	1.0	18
D405BP	DET	SI			330			10.0						8.0	800	1.0	18
D602A	VID	GE		86	600			10.0	15			3.2		500			15
D602B	VID	GE		85	600			10.0	20			3.2		500			15
D602V	DET	GE		85				9.4									15
D603	VID	SI			900			5.0				2.0		2H			17

GROUP XV, DIODES - PHOTOCONDUCTIVE

TYPE NUMBER	KIND	CATH AREA	MIN. DARK RES.	MAX. WORKING	SENS.	T. C. CURRENT	SPEC. SENS.		TEMP.	
		mm <sup>2</sup>	meg $\Omega$	v	$\mu\text{a/lm}$	%	MAX $\mu$	CUTOFF $\mu$	MIN (-) $^{\circ}\text{C}$	MAX (+) $^{\circ}\text{C}$
FS-AG	PHC	24	0.04	15	500	1.5	2.1	2.7	60	60
FS-A0	PHC	24	0.04	15	500	1.5	2.1	2.7	60	60
FS-AV	PHC	96	0.01	100	500	1.5	2.1	2.7	60	60
FS-D0	PHC	25	20.0	200	20M	2.0	0.75	1.2	60	40
FS-KG	PHC	25	3.3		6000	0.2	0.64	0.9	60	80
FS-K0	PHC	25	3.3	300	1200	0.12	0.52	0.9	60	80
FS-KV	PHC	50	1.6	200	6000	0.2	0.64	0.9	60	80
FS-A1	PHC	24	0.04	15	500	1.5	2.1	2.7	60	60
FS-D1	PHC	25	20.0	200	20M	2.0	0.75	1.2	60	40
FS-K1	PHC	25	3.3	400	6000	0.2	0.64	0.9		
FS-2A	PHC	9	0.3	17.5			0.7	3.5	60	40
FS-B2	PHC	121	0.2	50						
FS-K2	PHC	25	3.3	300	1200	0.12	0.52	0.9	60	80
FS-3A	PHC	52	2.0	10			0.7	3.5	60	40
FS-K3	PHC	25	3.3	300	1200	0.12	0.52	0.9	60	80
FS-A4	PHC	24	0.04	15	500	1.5	2.1	2.7	60	60
FS-K4	PHC	24	2.0	300	6000	0.2	0.64	0.9	60	80
FS-K5	PHC	7	10.0	300	3000	0.2	0.64	0.9	60	80
FS-A6	PHC	115	0.05	30	500	1.5	2.1	2.7	60	60
FS-D6	PHC	115	20.0	200	20M	2.0	0.75	1.2	60	40
FS-K6	PHC	115	3.3	300	3000	0.2	0.64	0.9	60	80
FS-K7	PHC	200	0.05	100	3500	0.2	0.64	0.9	60	80
FS-K8	PHC	15	10.0	300	1600	0.2	0.64	0.9	60	80

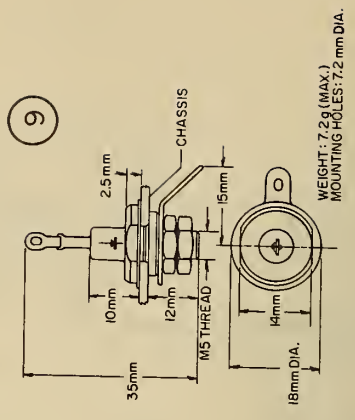
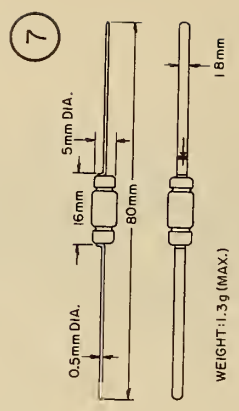
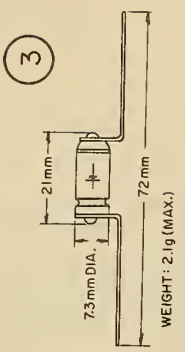
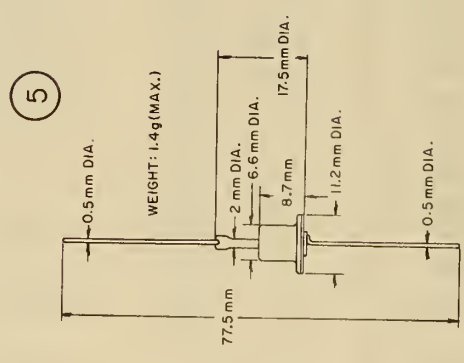
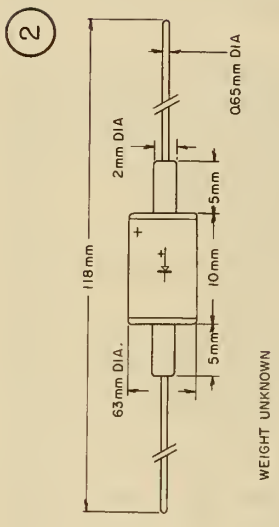
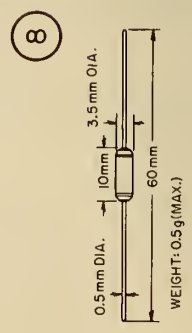
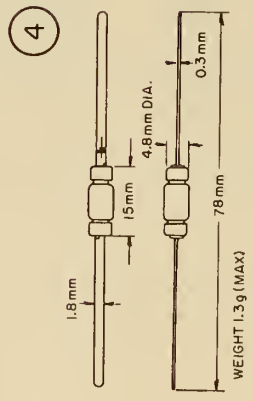
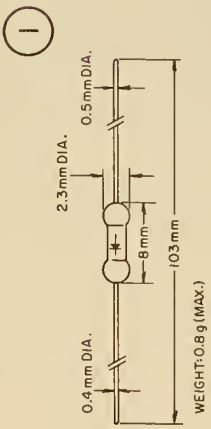

# DIODE OUTLINE DRAWINGS

## GROUPS IX, XII & XIII



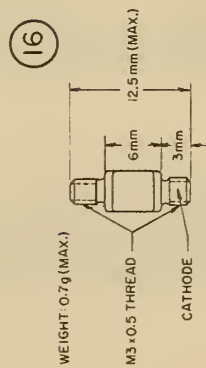
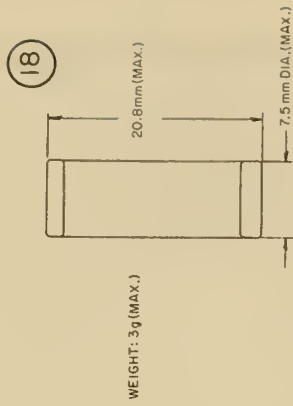
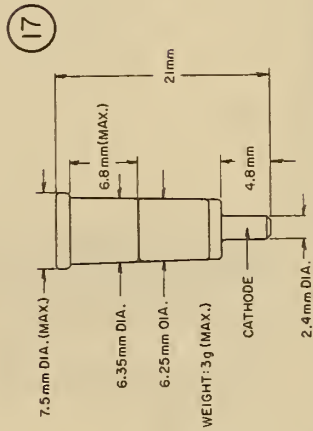
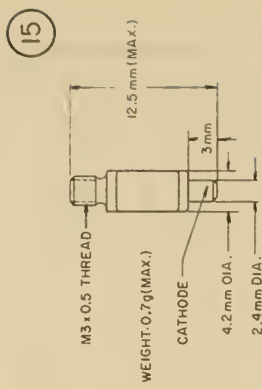
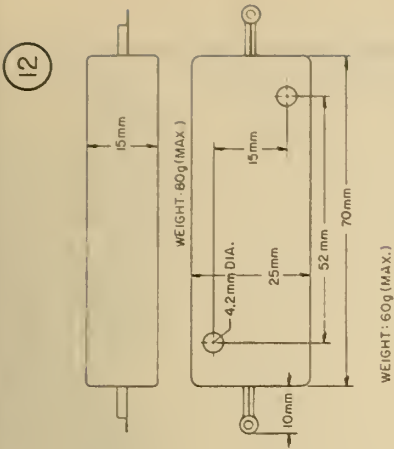
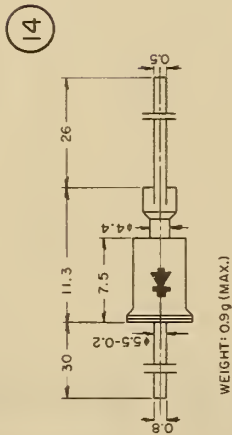
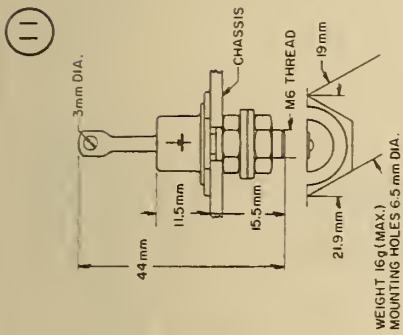
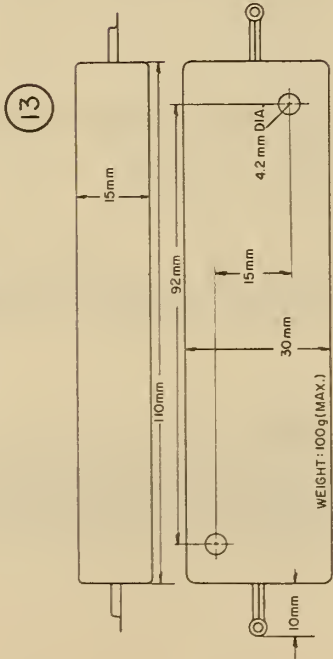
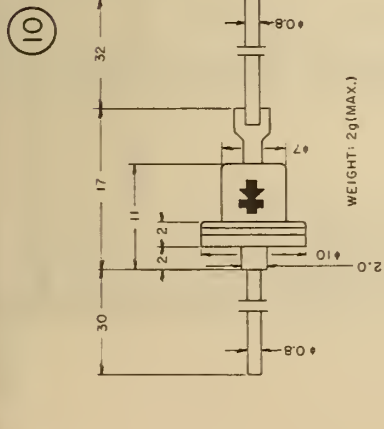

## DIODE OUTLINE DRAWINGS (CON'T)

GROUP XVI, PHOTOTUBES & MULTIPLIERS

TYPE NUMBER	KIND	BULB	DIMEN.		CATHODE		MAXIMUM		I <sub>omp</sub> /Lm		I <sub>0</sub> or *I <sub>Kamp</sub> /Lm		DYNODES		TYPE		
			DIAM	LTH.	AREA	SURF. SENS.	E <sub>b</sub>	I <sub>k</sub>	E <sub>b</sub>	DARK I <sub>k</sub>	E <sub>b</sub>	DARK I <sub>k</sub>	E <sub>b</sub>	DESIGN		MAT'L NO.	AMP. EXP.
			mm	mm	cm <sup>2</sup>	μg/L	v	μg	v	AMP. EXP.	v	AMP. EXP.	v				
FEU-1	PHM	G13		124		S2	400	250		220	1	7					
FEU-1B	PHM	G	80	285	44	S6	90	2000						L	AMK	11 6	
FEU-1B1V	PHM		80	225	44	S6	90	2500						C	AMK	10 7	
FEU-1B2V	PHM		80	225	44	S6	90	2500						C	AMK	12 7	
FEU-1S	PHM		48	205	12	S6	90	1950						L	AMK	11 6	
FEU-1V	PHM		48	166	12	S6	90	2500						C	AMK	10 7	
TSG-1	PHO	G18		131		S1	75	240	1	7						GS	
TSV-1	PHO	G18		131		S1	20	240	1	7						VC	
VSTS-1	PHO	G30		163			40	50								VC	
FEU-2	PHM	G10		71		S2	400	250		220	1	7					
FEU-2B	PHM		150	295	155	S6	90	2000						L	AMK	11 6	
FEU-2B1V	PHM		80	225	44	S6	90	2500						C		12 7	
FEU-2M	PHM		34	130	5	S6	90	1600						L	AMK	13 5	
FEU-2V	PHM		50	170	12	S6	90	2500						C	AMK	12 7	
STSV-2A	PHO	T6		67		S2	5	2	1	8						VC	
FEU-3B	PHM		200	295	227	S6	90	2000						L	AMK	11 6	
FEU-3M	PHM		19	75	□2	S6	90	1500						L	AMK	8 5	
FEU-R3	PHM		47	109	2	S6	90	1400						C		10	
STSV-3	PHO	G8		62		S2	80	240	1	8						VC	
TSG-3	PHO	G8		62		S1	100	240	1	7						GS	
TSV-3	PHO	G8		62		S1	20	240	1	7						VC	
STSV-4	PHO	G13		129		S2	80	240	1	7						VC	
TSG-4	PHO	G13		129		S1	100	240	1	7						VC	
TSV-4	PHO	G13		129		S1	20	240	1	7						GS	
FEU-R5	PHM		47	109	2	S6	90	1400						C		.10	
STSV-6	PHO	T13		104		S2	70	80	1	14						VC	
TSV-6	PHO	T9		104		S1		30	5	11						VC	
STSV-9	PHO	T13		104		S2		30	5	11						VC	
FEU-11	PHM		65	210	16	S6	80	2500						V	CAM	12 7	
FEU-12	PHM		65	210	16	S7	80	2500						V	CAM	12 7	
FEU-13	PHM		51	140	17	S6	50	2200						V	CAM	12 7	
FEU-14	PHM		52	162	17	S6	40	2200						V			
FEU-15	SCC		31	115			25	2200									
FEU-16	SCC		31	115			25	2200									
FEU-17	PHM	T16	48	181	□1	S6	20	1400	100	900	3	9	1400	*3	7	L	13

GROUP XVI, PHOTOTUBES & MULTIPLIERS

TYPE NUMBER	KIND	BULB	DIMEN.		CATHODE		MAXIMUM			I <sub>amp</sub> /Lm		I <sub>0</sub> or $\phi$ I <sub>k</sub> amp/Lm		DYNODES		TYPE					
			DIAM	LTH.	AREA	SURF.	SENS.	E <sub>b</sub>	I <sub>k</sub>	$\mu$ a	E <sub>b</sub>	AMP.	I <sub>k</sub>	AMP.	E <sub>b</sub>		AMP.	I <sub>k</sub>	AMP.	MATT'L	NO.
FEU-17A	PHM	T16	48	181	□1	S6	20					900	3	9	1400	3	7	L	13		
FEU-18	PHM	T16	48	181	□1	S3	20	1400	100			900	3	9	1400	*3	7	L	13		
FEU-18A	PHM	T16	48	181	□1	S3	20					900	3	9	1400	3	7	L	13		
FEU-19M	PHM	T16	48	195	9	S6	35	2600	200	1100	6	9	1400	6	8	2600	*1	5	L	13	
FEU-20	PHM	T11	34	95	50	S6	20	1400	100	900	8	9						L	8		
FEU-22	PHM	T16	48	181	□1	S1	25	2000	300	1400	2	8						L	13		
FEU-23	PHM		305	450	700		20	2400	10									L	AMK 11 5		
FEU-24	SCC		80	230	44	S6	25	2000	100			1600	3	7	2000			L	13 6		
FEU-25	PHM	T11	34	109	5	S6		1700	100	1250	5	8						L	9 6		
FEU-26L	PHM		22	70	□1	S6	20			900	2	8	1500		2000				7		
FEU-27	PHM		30	108	5	S7	30			1100	5	9							11		
FEU-29	SCC	T16	48	195	9	S6	30	2300	200			1400	3	8				L	13 7		
FEU-31	PHM		22	79	□3	S6	20			850			1300	5	7				8		
FEU-32	PHM		48	195	9	S6	70	1800	100									L	AMK 11 6		
FEU-33	SCC	T16	48	195	9	S6	30	2900							2100	1	6	L	13 7		
FEU-35	SCC		31	113	5	S6	30					1400	4	9					8		
FEU-40	NSP	T6	20	91		S6	30	1900		5	7								8		
FEU-42	NSP	T16	48	205		S6	30	2200		1	7								11		
FEU-43	NSP		80	290		S6	30	2200		1	7								11		
FEU-44	NSP		150	310		S6	30	2200		1	7								11		
FEU-45	NSP		200	340		S6	30	2200		1	7								11		
FEU-46	NSP	T16	48	130		S6	30	1800		1	10								10		
FEU-47	NSP		48	169		S6	30	2500		1	7								10		
FEU-48	NSP		80	230		S6	30	2500		1	7								10		
FEU-49	PHM		170	220	95	S20	80	3500				1800	1	8					12		
STSV51	PHO	G10		63		S2	80	240		1	8								VC		
FEU-52	PHM		80	125	45	S20	80	3000				1700	5	8					7		
FEU-53	PHM	T16	51	117	16	S9	40	2500				1700	4	7					7		

GROUP XVII, FLASH TUBES					
TYPE NUMBER	KIND	BULB SHAPE AND SIZE	MAXIMUM		TYP. TUBE DROP v
			VOLT. v	POWER w	
IST-10	FLS U		10H	10.0	180
IFK-20	FLS T6		700	2.0	100
IFK-50	FLS T6		10H	5.0	140
IFK-120	FLS U7		10H	12.0	180
IFP-200			20H	27.0	450
IFB-300	FLS U		15H	40.0	240
IFK-500	FLS H		35H	30.0	400
IFP-500	FLS ST3		30H	65.0	450
IFP-1500	FLS T3		40H	H10	900
IFK-2000	FLS U		20H	H30	250
IFP-4000	FLS T3		50H	H27	1K
IFP-15000	FLS T4		50H	K12	1K

GROUP XVIII, THERMOCOUPLE							
TYPE NUMBER	KIND	DIMENSIONS		TYPICAL		RESPONSE sec	f <sub>max</sub> mc
		DIAM mm	LENGTH mm	I <sub>H</sub> ma	THERMO ELEC mv		
TVB-1	THM	20	30	1	3	40	200
TV-2	THM	13	23	100	30	35	5
TVB-2	THM	20	30	3	5	40	200
TVB-3	THM	20	30	5	10	40	200
TV-4	THM	13	23	50	30	35	5
TVB-4	THM	20	30	10	12	40	200
TV-5	THM	13	23	75	30	35	5
TVB-5	THM	20	30	30	12	40	200
TVB-6	THM	20	30	30	12	40	200
TVB-7	THM	20	30	100	12	40	200
TVB-8	THM	20	30	300	12	40	200
TVB-9	THM	20	30	500	12	40	200
TV-14	THM	13	23	250	30	15	5
TV-15	THM	15	20	500	30	35	5
TV-16	THM	15	20	1000	30	35	5



## GROUP XIX, THERMISTORS

TYPE NUMBER	KIND	USE	DIMEN			RESISTANCE			TEMP.		POWER		SENS $\frac{\Omega}{mW}$
			DIAM	LTH	SHAPE	MIN	MAX	T.C.	MIN	MAX	MIN	MAX	
			mm	mm		$\Omega$	$\Omega$	%	(-) °C	(+) °C	mW	mW	
KMT-1	TMS	MEA	13	□4	CYL	20K	1M	5.1	20	180		8H	
MMT-1	TMS	MEA	13	□4	CYL	1	200	2.9	70	120		4H	
KMT-4	TMS	MEA	24	7	CYL	20K	1M	5.1	20	180		8H	
MMT-4	TMS	MEA	24	7	CYL	1	200	2.9	70	120			
MMT-6	TMS					10	1000	2.9	70	120		50	
KMT-8	TMS					100	10K	4.6	40	60			
MMT-8	TMS	COM	22	23	DSC	1	1000	2.9	40	60		10	
T8D	TMS	POW	8	3	CYL	150					10	15	20
T8E	TMS	POW	8	3	CYL	150					7	10	30
T8M	TMS	POW	8	3	CYL	200					9	11	66
T8R	TMS	POW	8	3	CYL	125					7	12	10
T8S1	TMS	POW	8	3	CYL	120					9.5	24	10
T8S1M	TMS	POW	8	3	CYL	120					9.5	24	10
T8S2	TMS	POW	8	3	CYL	150					8	19	12
T8S2M	TMS	POW	8	3	CYL	150					8	19	12
T8S3	TMS	POW	8	3	CYL	150					7	23	10
T8S3M	TMS	POW	8	3	CYL	150					7	23	10
MMT-9	TMS	COM	□3	19	DSC	10	5000	2.9	60	120		10	
T9	TMS	POW	8	3	CYL	125					7	19	10
KMT10	TMS	CON	30	6	CYL	100K	3M	5.1	0	120		2H	
KMT-11	TMS	CON	□4	□1	CYL	100K	3M	5.1	0	120		2H	
KMT-12	TMS					100	10K	4.6	40	120			
MMT-12	TMS					5	5K	2.9	40	120		3	

## GROUP XX STROBOTRONS

TYPE NUMBER	DIMENSIONS			VOLTAGE			POWER			INTER RES			FLASH CONDITIONS				LIGHT OUTPUT			LIFE	
	SHAPE	DIAM	LTH	MIN DROP	OPER	FIRING	AVG	PEAK	RES	DISCHG CAP	TIME	FLASH FREQ	ENERGY	FLASH	AVG	PEAK	NO OF FLSH	HRS			
		mm	mm	v	v	v	w	kw	$\Omega$	$\mu$ f	$\mu$ s	cps	j	c/sec	c						
ISK10	U	5	30	180	300	1000	10	3	0.8	1.0	15	200	0.1	70	15	500	50				
ISP10	T	1	62	700	1000	3000	10	6	30	0.2	18	100	0.1	500	5	3K	500				
IST10	U	5	30	180	300	1000	10	50	0.8	220	200	1	10	8	40K	50					
IFK15-1	T	29	60	300	300	300	3	90	1.5	800	400	0.1	36	36	9K	2K					
IS SH15	T	1	2	250	1000	1200	1	20	20	15	5	300K	1	5K							
IFK20	T	4	10	100	130	700	2	100	1.6	25H	200	0.1	20	20	100K	10K					
ISK25	U	5	20	250	300	1000	20	130	0.4	450	150	1	20	40	30K	30					
IFK50	T	4	20	140	200	1K	5	125	0.3	25H	400	0.1	50	70	180K	10K					
ISP70	T	0.5	70	900	1200	3000	70	10	1H	0.2	18	400	0.2	1000	40	6K	100				
IS SH100-1	T	0.7	2	2200	3000	3500	4000	11	15	50	3M	1	2								
IS SH100-3	T	2	5	2500	3500	6K	150	1000	0.5	2	50	3	2	100	600K	5					
1FK120	U	5	30	180	300	1K	12	120	0.8	25H	1K	0.1	120	250	250K	10K					
1FP200	T	5	200	450	500	2K	27	140	2.0	16H	16H	0.13	200	400	250K	10K					
1FB300	R	8	85	240	300	1500	40	36	2.5	65H	8K	0.13	300	500	60K	10K					
1FK500	P	30	45	400	500	3500	30	65	4.0	4K	8K	0.05	500	1000	130K	10K					
1FP500	T	5	350	450	500	3K	65	70	3.5	4K	7K	0.13	500	1000	140K	10K					
IS SH500	T	1.2	8	5K	9K	15K	500	1000	0.12	6	100	5	5	500	1M	1					
1FP1500	T	5	600	900	1K	4K	100	160	6.0	3K	9K	0.06	15H	4000	450K	10K					
1FK2000	U	9	70	250	320	2K	300	200	4.5	8K	2K	0.7	400	1200	600K	40K					
1FP4000	T	6	800	1300	1400	5K	270	250	8.0	4K	16K	0.06	4K	12K	750K	10K					
1FP15000	T	9	600	1600	2400	5K	1250	3300	1.8	5K	45H	0.08	15K	50K	11M	10K					
IFK20000	G	85	2K	3K	6K	20K	55H	10M	3.5	550	11H	0.55	10K	34K	30M	7K					
1FK80000	G	1H	3K	6K	20K	20K	18K	13M	2.5	39H	5K	0.25	70K	240K	36M	5K					

GROUP XXI, COUNTERS

TYPE NUMBER	KIND	RADIATION	QUENCHING	CATHODE	DIMENSIONS		PLATEAU		MAXIMUM			TEMP		CAP pf	MIN R <sub>i</sub> meg Ω	FIG
					DIAM mm	LENGTH mm	MIN v	MAX v	RATE <sup>3</sup> 10/min	PLATEAU		MIN -°C	MAX +°C			
										WIDTH v	SCOPE % v					
SI-1BG	COU	BAG	SQ	NI	60	15	375	410				40	50	5	11	
SI-1G	COU	BET	SQ	FE	94	16	280	320	60	80	1.25	40	50	10	5	8
STS-2	COU	BET	SQ	FE	180	24	285	335	40	80	1.25	40	50	10	5	9
SI-2B	COU	BET	SO	SN	90	70	1350	1750	8	150	0.5	30	50	10	7	13
SI-2BG	COU	BAG	SO	NI	60	15	375	410				40	50	5	3	12
STS-3	COU	BET	SO	FE	265	23	285	335	30	80	1.25	40	50	10	5	8
SI-3B	COU	BET	SO	CU	90	40	1650		10	150	0.3	20	40	10	7	6
GS-4	COU	GAM	SQ	GR	180	23	1100	1300		200	1.0			25	8	3
MS-4	COU	GAM	SO	CU	180	23	720	780	25	200	1.0	40	50	25	8	4
MSTR-4	COU	BET	SQ	CU	180	40	1200	1350	25	200	0.5	5	35	25	8	7
SI-4G	COU	GAM	SQ	W	367	33	720	800	25	200	1.0	40	150	25	8	1
VS-4	COU	GAM	SQ	W	180	23	720	800	25	200	0.75	40	50	25	8	1
STS-5	COU	BET	SO	FE	113	12	280	330	100	80	1.25	40	50	10	5	9
GS-6	COU	GAM	SO	GR	266	23	1100	1300		200	1.0			25	8	3
MS-6	COU	GAM	SO	CU	266	23	720	780	25	200	1.0	40	50	25	8	4
STS-6	COU	BET	SQ	FE	200	22	285	335	60	80	1.25	40	50	10	5	10
VS-6	COU	GAM	SO	W	266	23	720	800	25	200	0.75	40	50	25	8	1
GS-7	COU	GAM	SO	GR	145	16	1100	1300		150	1.0			25	30	3
MS-7	COU	GAM	SO	CU	145	16	720	780	25	100	1.5	25	50	25	30	4
GS-8	COU	GAM	SO	GR	185	16	1100	1300		150	1.0			25	30	3
MS-8	COU	GAM	SO	CU	185	16	720	780	25	100	1.5	25	50	25	30	4
STS-8	COU	BET	SQ	FE	220	23	285	335	40	80	1.25	40	50	10	5	8
VS-8	COU	GAM	SO	W	185	16	720	800	25	150	1.0	40	50	25	30	1
GS-9	COU	GAM	SQ	GR	367	33	1100	1300		250	1.0			25	8	3
MS-9	COU	GAM	SQ	CU	367	33	720	780	25	250	1.0	40	50	25	8	4
VS-9	COU	GAM	SO	W	367	33	720	800	25	250	0.75	40	50	25	8	1
GS-10	COU	GAM	SO	GR	225	16	1100	1300		150	1.0			25	30	3
GS-11	COU	GAM	SO	GR	185	33	1100	1300		200	1.0			25	8	3
MS-11	COU	GAM	SO	CU	185	33	720	780	25	200	1.0	40	50	25	8	4
VS-11	COU	GAM	SO	W	185	33	720	800	25	200	0.75	40	50	25	8	1
GS-12	COU	GAM	SO	GR	145	16	1100	1300		150	1.0			25	30	3
MS-12	COU	GAM	SQ	CU	145	16	720	780	25	100	1.5	25	50	25	30	4
MS-13	COU	GAM	SQ	CU	100	23	720	780	25	200	1.5	40	50	25	8	5
VS-13	COU	GAM	SO	W	100	23	720	800	25	150	1.0	40	50	25	8	2
MS-14	COU	GAM	SO	CU	160	23	720	780	25	200	1.0	40	50	25	8	5
VS-14	COU	GAM	SO	W	160	23	720	800	25	200	0.75	40	50	25	8	2
MS-16	COU	GAM	SQ	CU	250	23	720	780	25	200	1.0	40	50	25	8	5
VS-16	COU	GAM	SO	W	250	23	720	800	25	200	0.75	40	50	25	8	2
MST-17	COU	BET	SQ	CU	100	40	1600		10	150	0.5	30	50	10	7	6
GS-30	COU	GAM	SO	GR	662	33	1100	1300		150	1.0			25	8	3
GS-60	COU	GAM	SQ	GR	667	63	1100	1300		150	1.0			25	8	3

### GROUP XXII DISCHARGE DIODES

TYPE NUMBER	DIMEN		GAS	CATH		FIRING		PULSE			MIN INTER RES mea Ω	MAX CAP pf	AMB. TEMP		
	LTH	DIAM		TYPE	KIND	MIN	MAX	I-amp J-joule	TIME sec	OPERATING FREQUENCY cps			MIN	MAX	
	mm	mm				v	v								(-)°C
RB-1	52	19		C	BA	150	190				400				
R-2	17	16.5		C		1300	2K			600	20		50	80	
RB-2	25	19		C	BA		220	50	15U	50	100	□1	60	70	
R-3	70	21.5		C	BAO		600	140	12U	300	100	1	60	70	
RB-3	41	22		C	BA	220	235	30	1HU	7	100		60	70	
R-4				C	BAO		75								
R-5	41	22		C	BAO	160	250				100				
RB-5	60	16		C	BA	340	460	10J		1	200		60	70	
RB-5A	60	16		C	BA	370	510	□1J		8			60	50	
R6	110	55				800				200 M	100				
R-7	45	18	HK	C	BAO	270	330			2	20	10	60	100	
R-8	50	20	HK	C	BAO	450	550			2	20	10	60	100	
R-9	55	20	HK	C	BAO	900	1100			2	20	10	60	100	
R-10	55	20	HK	C	BAO	1375	1725			2	20	40	60	100	
R-11	132	35		C	NI	2250	2750	2HU							
R-12	30	12	AR	C	K	145	175	20	1U		1000				
R-54						7200	9800								
RB-90	62	17.5	NA	C	BA	80	100	30M	2	0.005	100	100	60	70	
SK-127	37	20	NA		MG		72	1	20	1					
SK-220	37	20	HE				140	□1	20	1					
RB-280	210	95	AR	C	BA	250	310	30	10	0.002	40	20	60	70	
R-350	62	20	AR	C	BA	310	390	3	2	0.002	5K	10	50	50	
RB-350	210	95	AR	C	BA	310	390	30	10	0.002	40	20	60	70	
RB-430	210	95	AR	C	BA	390	470	30	10	0.002	40	20	60	70	
R-450	62	20	AR	C	BA	440	480	3	2	0.002	5K	10	50	50	

### GROUP XXIII DECATRONS

TYPE NUMBER	KIND	VOLTAGES						TYP I <sub>b</sub> ma	PULSE		DIMEN	
		MAXIMUM			TYPICAL				TYP	MAX	LTH	DIA
		E <sub>b</sub> v	FIRING v	BIAS v	DRP v	OPER v	K <sub>1</sub> K <sub>2</sub> v		TIME μs	RATE kc/s	mm	mm
OG-1	DEC	450	300	150	15	150	50	1.3	40	8	77	34
OG-2	DEC	450	300	150	15	150	50	1.3	60	3	77	34
OG-3	DEC	460	420	120	15	190	40	0.7	18	20	83	34
OG-5	DEC	400	350	120	20	175	60	1.3	35	10	74	34

### GROUP XXIV LIGHT AMPLIFIERS

TYPE NUMBER	KIND	K	SCRN COLOR	MAX. DIMEN			AMP μ	TYP E <sub>b</sub> v	RESOL	
				K	SCREEN				LINE PER mm	
					mm	mm				mm
LIM-3	LAM	CSB	VB	15	65	20	2	18	8	70
LIM-4	LAM	CSB	VB	15	135	40	4	18	9	70



GROUP XXV, BASES

BASE NO.	SECTION I										SECTION 2					SEC. 4			DEFLECTION I				DEFLECTION 2					
	H	H	K	g <sub>1</sub>	g <sub>2</sub>	g <sub>3</sub>	g <sub>4</sub>	g <sub>5</sub>	A	Sh	H	H	K	g <sub>1</sub>	g <sub>2</sub>	g <sub>3</sub>	A	A <sub>3</sub>	K	A	A <sub>5</sub>	D <sub>1</sub>	D <sub>2</sub>	D <sub>3</sub>	D <sub>4</sub>			
A4	2	4	3	1				CP																				
A7	1	7	6	5				2									3 CP											
A8	2	8	7	5				3									CP											
A9	2	7	6	4				CP																				
A12	1	12	2	3				8									4				6	9	10	7				
A14	1	14	2	3				9									5 CP				CP	CP	CP	CP				
A20	1	20	3	5	16			11									CP				CP	CP	CP	CP				
A25	1	25	2	24	6			23		13	14	15	12	6			11				20	5	4	21	17	9	8	18
B7	3	4	2	5	7			6									CP											
BT7	1	7	4	2	3	4		CP					6				CP											
B8	1	8	3	6				CP																				
B9	3	9	1	8				6																				
B12	1	12	11	2	10			6																				
B14	1	14	2	3				9									CP				CP	CP	10	7	8	11		
CB	1	6	7	2	6			4									CP											
C14	1	14	13	12	CP			CP																				
D8	2	8	6	4				CP																				
D14	1	14	2	3	4			5																				
DS2	2	7	2					CP																				
DS3	1	5						CP																				
DS4	2	7						4																				
DW1	2	8						4																				
DW2	1	2	3					4																				
DW3	1	8	3					2	4																			
DW4	2	8	8					4																				
DW5	2	6	3					1	4																			
DW6	3	4	5					7					5															
DW7	2	7	8					3																				
DW8	1	3	2					4																				
DW9	3	4	1					7					5															
F8	1	8	7	6	3			5																				
G8	1	8	6					CP																				
ID1	4	5	2	1				7																				
P1S	4	5	3	2	9	1		7	1																			
P3S	1	7	8	6	3	4		2	5																			
P4S	1	7		4	6	1		CP																				

GROUP XXV, BASES

BASE NO.	SECTION I										SECTION 2										SEC. 4			DEFLECTION I				DEFLECTION 2				
	H	H	K	K	g <sub>1</sub>	g <sub>2</sub>	g <sub>3</sub>	g <sub>4</sub>	g <sub>5</sub>	A	Sh	H	H	K	K	g <sub>1</sub>	g <sub>2</sub>	g <sub>3</sub>	A	A <sub>3</sub>	K	A	A <sub>5</sub>	D <sub>1</sub>	D <sub>2</sub>	D <sub>3</sub>	D <sub>4</sub>	D <sub>1</sub>	D <sub>2</sub>	D <sub>3</sub>	D <sub>4</sub>	
P55	1	8			2	3	5		6	7																						
P6S	1	2			3	4	6		CP																							
P7S	1	7			4	3	5		6																							
P8S	4	5			3	1	6		7																							
P9S	4	8			1	2	3	5		6	7																					
P10	2	7			8	CP	4	1		CP																						
P11	1	2				3	CP	6		CP																						
P12	1	6			4	3	5		CP																							
P13	1	7			4	3	5		CP																							
P14	2	7			5	3	4		CP																							
P15	1	6			7	CP	3	5		CP																						
P17	4	5			3	9	1	8		6																						
P18	8	9			3	5	2	4		1																						
P19	2	7			4	5	3		CP																							
PD1	4	5			7	2	8	7		6																						
PD2	4	5			2	7	1	2		3																						
PD3	4	5			1	2	9	7		6																						
PD4	3	4			7	1	2	7		5																						
PD5	2	7			1	5	4	1		3																						
PD6	2	7			8	CP	6	1		3																						
PD7	4	5			2	1	7	2		9																						
PD8	6	8			3	1	2	3		CP																						
PS1	1	8			6	7	5	2		3	4																					
PS2	1	7			6	3	4		2	5																						
PS3	1	8			7	5	4		3	2																						
PS4	4	5			3	7	1		CP	2																						
PS5	4	5			6	7	3	2		1																						
PS6	1	7			4	6	2		CP																							
PS7	2	7			8	5	4	8		CP																						
PS8	2	7			4	5			CP																							
PS9	4	5			3	7	2	3		1																						
PT1	3	5			2	1	6		4																							
PT2	7	8			6	CP	3	6		2																						
PT3	2	7			8	1	4	8		6																						
T1S	1	4			3				CP																							
T2S	4	5			1	2			7																							

GROUP XXV, BASES

BASE NO.	SECTION I										SECTION 2					SEC. 4				DEFLECTION I				DEFLECTION 2						
	H	H	K	g <sub>1</sub>	g <sub>2</sub>	g <sub>3</sub>	g <sub>4</sub>	g <sub>5</sub>	A	Sh	H	H	K	g <sub>1</sub>	g <sub>2</sub>	g <sub>3</sub>	A	A <sub>3</sub>	K	A	A <sub>5</sub>	D <sub>1</sub>	D <sub>2</sub>	D <sub>3</sub>	D <sub>4</sub>	D <sub>1</sub>	D <sub>2</sub>	D <sub>3</sub>	D <sub>4</sub>	
T3S	1	4	5	3					2																					
TD1	4	8	6	7					1																					
TD3	2	7	8	CP					3																					
TE2	1	7		2	CP				4																					
TE3	4	5		8	2				3					CP																
TE4	1	3		2	4				CP																					
TE5	1	3		4	2				CP																					
TE6	2	7		5	4				CP																					
TE7	1	7	7	3	6				CP																					
TS1	1	7		5					2																					
TS2	2	3		4					1																					
TS3	1	3	2	6					4																					
TS4	4	5	3	1					9																					
TS5	2	7	8	CP					CP																					
TS6	2	6	3	5					4																					
TS7	4	5	9	2					1																					
TS8	2	7	1	5					CP	3																				
TS9	2	7		CP					CP																					
TT1	4	5	7	8					9																					
4AC	2	7	7						CP																					
4AJ									5	3																				
4BB	2	7	8	CP					CP																					
4BQ	2	7	8						3																					
4D	1	4		3					2																					
4F	1	3		4					2																					
4G	1	4	3						2																					
4T2	1	2		4					CP																					
SAA	2	7	8						5																					
SAW	1	5	4	3	2	4			CP																					
SBT	2	7	3	5	8	3			CP																					
5CL	3	5	4	2	5				1																					
5F	1	5	4	CP	3	4			2																					
5M	2	7	8	CP					4																					
5S	2	7		5					3																					
5Y	2	7		CP	4	7			3																					
6AR	1	7		6	3	5			2																					







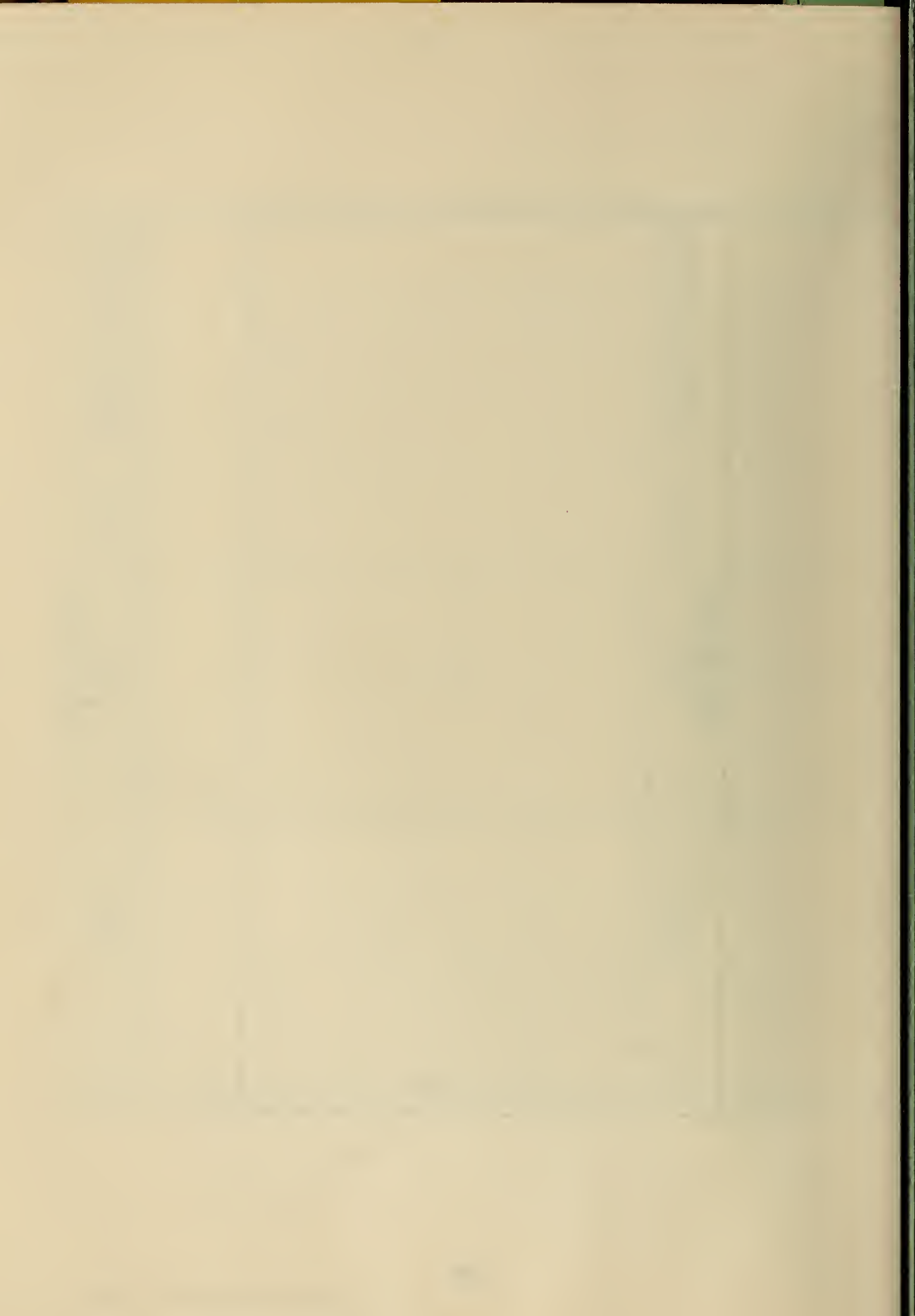



## THE NATIONAL BUREAU OF STANDARDS

The scope of activities of the National Bureau of Standards at its major laboratories in Washington, D.C., and Boulder, Colorado, is suggested in the following listing of the divisions and sections engaged in technical work. In general, each section carries out specialized research, development, and engineering in the field indicated by its title. A brief description of the activities, and of the resultant publications, appears on the inside of the front cover.

### WASHINGTON, D. C.

**Electricity.** Resistance and Reactance. Electrochemistry. Electrical Instruments. Magnetic Measurements. Dielectrics. High Voltage.

**Metrology.** Photometry and Colorimetry. Refractometry. Photographic Research. Length. Engineering Metrology. Mass and Scale. Volumetry and Densimetry.

**Heat.** Temperature Physics. Heat Measurements. Cryogenic Physics. Equation of State. Statistical Physics.

**Radiation Physics.** X-ray. Radioactivity. Radiation Theory. High Energy Radiation. Radiological Equipment. Nucleonic Instrumentation. Neutron Physics.

**Analytical and Inorganic Chemistry.** Pure Substances. Spectrochemistry. Solution Chemistry. Standard Reference Materials. Applied Analytical Research. Crystal Chemistry.

**Mechanics.** Sound. Pressure and Vacuum. Fluid Mechanics. Engineering Mechanics. Rheology. Combustion Controls.

**Polymers.** Macromolecules: Synthesis and Structure. Polymer Chemistry. Polymer Physics. Polymer Characterization. Polymer Evaluation and Testing. Applied Polymer Standards and Research. Dental Research.

**Metallurgy.** Engineering Metallurgy. Microscopy and Diffraction. Metal Reactions. Metal Physics. Electrolysis and Metal Deposition.

**Inorganic Solids.** Engineering Ceramics. Glass. Solid State Chemistry. Crystal Growth. Physical Properties. Crystallography.

**Building Research.** Structural Engineering. Fire Research. Mechanical Systems. Organic Building Materials. Codes and Safety Standards. Heat Transfer. Inorganic Building Materials. Metallic Building Materials.

**Applied Mathematics.** Numerical Analysis. Computation. Statistical Engineering. Mathematical Physics. Operations Research.

**Data Processing Systems.** Components and Techniques. Computer Technology. Measurements Automation. Engineering Applications. Systems Analysis.

**Atomic Physics.** Spectroscopy. Infrared Spectroscopy. Far Ultraviolet Physics. Solid State Physics. Electron Physics. Atomic Physics. Plasma Spectroscopy.

**Instrumentation.** Engineering Electronics. Electron Devices. Electronic Instrumentation. Mechanical Instruments. Basic Instrumentation.

**Physical Chemistry.** Thermochemistry. Surface Chemistry. Organic Chemistry. Molecular Spectroscopy. Elementary Processes. Mass Spectrometry. Photochemistry and Radiation Chemistry.

Office of Weights and Measures.

### BOULDER, COLO.

**Cryogenic Engineering Laboratory.** Cryogenic Equipment. Cryogenic Processes. Properties of Materials. Cryogenic Technical Services.

### CENTRAL RADIO PROPAGATION LABORATORY

**Ionosphere Research and Propagation.** Low Frequency and Very Low Frequency Research. Ionosphere Research. Prediction Services. Sun-Earth Relationships. Field Engineering. Radio Warning Services. Vertical Soundings Research.

**Radio Propagation Engineering.** Data Reduction Instrumentation. Radio Noise. Tropospheric Measurements. Tropospheric Analysis. Propagation-Terrain Effects. Radio-Meteorology. Lower Atmosphere Physics.

**Radio Systems.** Applied Electromagnetic Theory. High Frequency and Very High Frequency Research. Frequency Utilization. Modulation Research. Antenna Research. Radiodetermination.

**Upper Atmosphere and Space Physics.** Upper Atmosphere and Plasma Physics. High Latitude Ionosphere Physics. Ionosphere and Exosphere Scatter. Airglow and Aurora. Ionospheric Radio Astronomy.

### RADIO STANDARDS LABORATORY

**Radio Physics.** Radio Broadcast Service. Radio and Microwave Materials. Atomic Frequency and Time-Interval Standards. Radio Plasma. Millimeter-Wave Research.

**Circuit Standards.** High Frequency Electrical Standards. High Frequency Calibration Services. High Frequency Impedance Standards. Microwave Calibration Services. Microwave Circuit Standards. Low Frequency Calibration Services.

