

NATIONAL BUREAU OF STANDARDS REPORT

3427

PRINCIPLES OF FIRE DETECTION IN AIRCRAFT
ENGINE SPACES

by

W. F. Roeser
C. S. McCamy

Report to
WRIGHT AIR DEVELOPMENT CENTER



U. S. DEPARTMENT OF COMMERCE
NATIONAL BUREAU OF STANDARDS

U. S. DEPARTMENT OF COMMERCE

Sinclair Weeks, *Secretary*

NATIONAL BUREAU OF STANDARDS

A. V. Astin, *Director*



THE NATIONAL BUREAU OF STANDARDS

The scope of activities of the National Bureau of Standards is suggested in the following listing of the divisions and sections engaged in technical work. In general, each section is engaged in specialized research, development, and engineering in the field indicated by its title. A brief description of the activities, and of the resultant reports and publications, appears on the inside of the back cover of this report.

Electricity. Resistance and Reactance Measurements. Electrical Instruments. Magnetic Measurements. Electrochemistry.

Optics and Metrology. Photometry and Colorimetry. Optical Instruments. Photographic Technology. Length. Engineering Metrology.

Heat and Power. Temperature Measurements. Thermodynamics. Cryogenic Physics. Engines and Lubrication. Engine Fuels. Cryogenic Engineering.

Atomic and Radiation Physics. Spectroscopy. Radiometry. Mass Spectrometry. Solid State Physics. Electron Physics. Atomic Physics. Neutron Measurements. Infrared Spectroscopy. Nuclear Physics. Radioactivity. X-Ray. Betatron. Nucleonic Instrumentation. Radiological Equipment. Atomic Energy Commission Radiation Instruments Branch.

Chemistry. Organic Coatings. Surface Chemistry. Organic Chemistry. Analytical Chemistry. Inorganic Chemistry. Electrodeposition. Gas Chemistry. Physical Chemistry. Thermochemistry. Spectrochemistry. Pure Substances.

Mechanics. Sound. Mechanical Instruments. Fluid Mechanics. Engineering Mechanics. Mass and Scale. Capacity, Density, and Fluid Meters. Combustion Control.

Organic and Fibrous Materials. Rubber. Textiles. Paper. Leather. Testing and Specifications. Polymer Structure. Organic Plastics. Dental Research.

Metallurgy. Thermal Metallurgy. Chemical Metallurgy. Mechanical Metallurgy. Corrosion.

Mineral Products. Porcelain and Pottery. Glass. Refractories. Enameled Metals. Concreting Materials. Constitution and Microstructure.

Building Technology. Structural Engineering. Fire Protection. Heating and Air Conditioning. Floor, Roof, and Wall Coverings. Codes and Specifications.

Applied Mathematics. Numerical Analysis. Computation. Statistical Engineering.

Electronics. Engineering Electronics. Electron Tubes. Electronic Computers. Electronic Instrumentation. Process Technology.

Radio Propagation. Upper Atmosphere Research. Ionospheric Research. Regular Propagation Services. Frequency Utilization Research. Tropospheric Propagation Research. High Frequency Standards. Microwave Standards.

● Office of Basic Instrumentation

● Office of Weights and Measures.

NATIONAL BUREAU OF STANDARDS REPORT

NBS PROJECT

NBS REPORT

1002-20-4821

3427

PRINCIPLES OF FIRE DETECTION IN AIRCRAFT
ENGINE SPACES

W. F. Roesser
C. S. McCamy

WRIGHT AIR DEVELOPMENT CENTER



**U. S. DEPARTMENT OF COMMERCE
NATIONAL BUREAU OF STANDARDS**

The publication, reprint, or translation of this report is prohibited unless permission is obtained from the National Institute of Standards and Technology, Gaithersburg, Maryland 20899. Such permission is not necessary for the reproduction of this report for its own use.

Approved for public release by the
Director of the National Institute of
Standards and Technology (NIST)
on October 9, 2015.

part, is prohibited
dards, Washington
rt has been specifi-
rt for its own use.

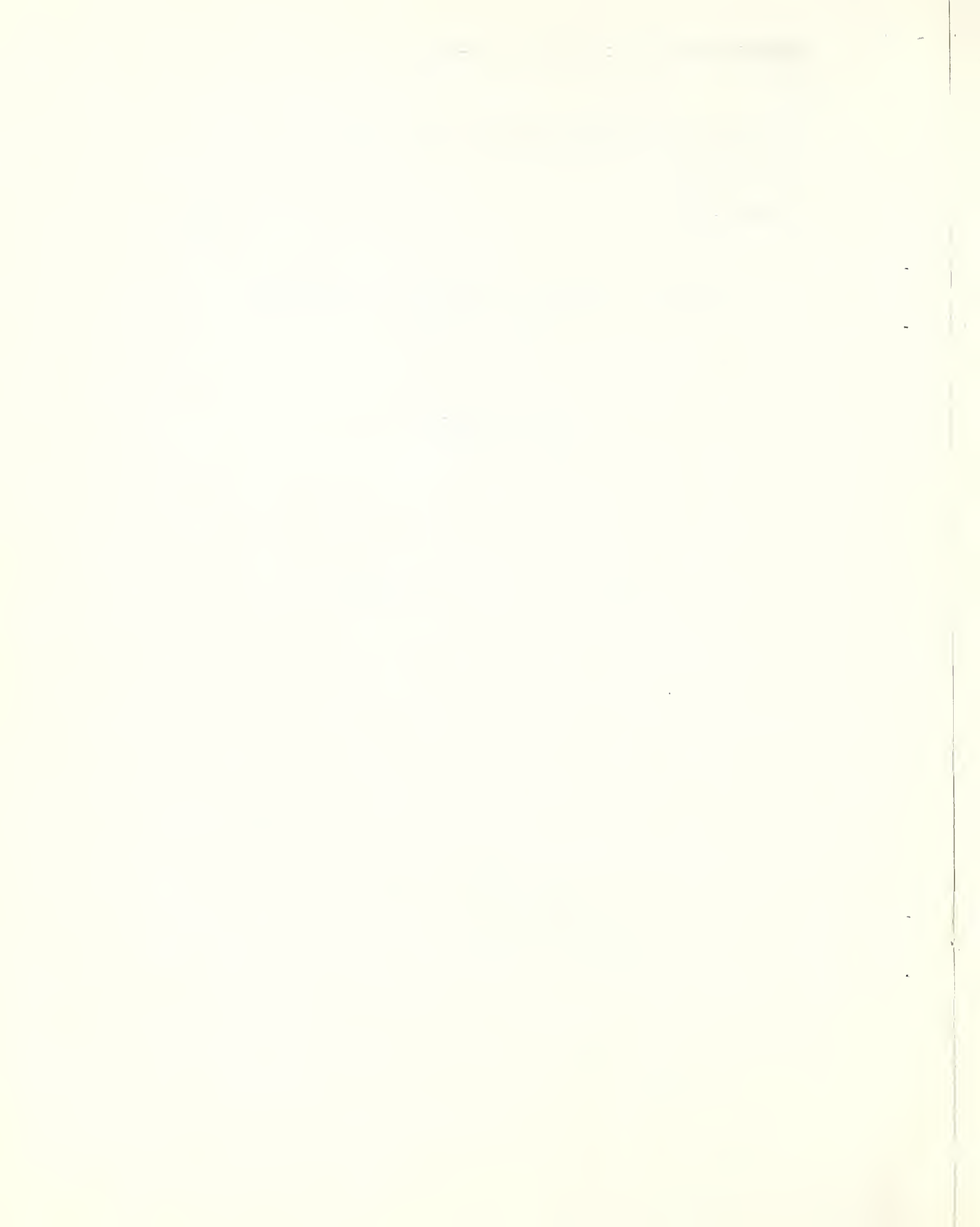

NBS Report No. 3427

PRINCIPLES OF FIRE DETECTION IN AIRCRAFT
ENGINE SPACES

W. F. Roeser
C. S. McCamy
National Bureau of Standards

Contract No. (33-616)-52-16
Change Order C-1
Expenditure Order No. R-664-300 B11

Wright Air Development Center
Air Research and Development Command
United States Air Force
Wright-Patterson Air Force Base, Dayton, Ohio

THE UNIVERSITY OF CHICAGO

THE UNIVERSITY OF CHICAGO

THE UNIVERSITY OF CHICAGO

THE UNIVERSITY OF CHICAGO

THE UNIVERSITY OF CHICAGO

THE UNIVERSITY OF CHICAGO

FOREWORD

The investigation covered by this report was conducted at the National Bureau of Standards, Washington, D. C., under WADC Contract No. (33-616)-52-16, Change Order No. C-1, and Expenditure Order No. R-664-300 B11. This report was prepared by W. F. Rooser and C. S. McCamy. The assistance of M. A. Barron in carrying out parts of the experimental work is gratefully acknowledged. The project engineer of the Equipment Laboratory of Wright Air Development Center was G. T. Beery.

Subsequent to the receipt of the above information, and
having regard to the provisions of the said Act, the
Commissioner of Customs and Excise has decided to
grant a licence to the said person to import into
the United Kingdom a quantity of the said goods
not exceeding the amount specified in the licence
to be issued to him, and to permit him to sell
the said goods in the United Kingdom, and to
export the said goods from the United Kingdom
and to permit him to re-import the said goods
into the United Kingdom.

1954

CONTENTS

	<u>Page</u>
FOREWORD	ii
ABSTRACT	vii
INTRODUCTION	viii
SECTION I Operating Principles of Fire Detectors	1
1.1 Igniting Effect	1
1.2 Contact Heating Effect	1
1.2.1 Predetermined Temperature Level	2
1.2.2 Rate of Temperature Rise	3
1.3 Effects of Radiant Energy	5
1.3.1 Radiant Flux (Radiant Energy per Unit of Time)	5
1.3.2 Rate of Change in Radiant Flux	5
1.3.3 Ratio of Radiant Intensities in Two Wavelength	5
Intervals	5
1.3.4 Variations in Radiant Flux	6
1.4 Ionization Effects	6
1.4.1 Flame Conductivity	6
1.4.2 Flame Rectification	6
1.4.3 Microwave Attenuation	7
1.5 Effects of Combustion Products	7
1.5.1 Gas Analysis	7
1.5.2 Smoke	7
1.5.3 Doppler Effect	7
1.6 Detection of Combustible Vapors	7
SECTION II Flame Effects Investigated	8
SECTION III Radiation Effects	9
3.1 Amount of Radiant Flux	13
3.1.1 Burners and Fuels	14
3.1.2 Apparatus and Procedure	17
3.1.3 Radiometric Terminology	26
3.1.4 Results	29
3.2 The Flicker of Flames	47
3.3 Rate of Change in Radiant Flux	56
SECTION IV Contact Heating Effects	58
SECTION V Flame Conduction	64

CONTENTS

11	11
12	12
13	13
14	14
15	15
16	16
17	17
18	18
19	19
20	20
21	21
22	22
23	23
24	24
25	25
26	26
27	27
28	28
29	29
30	30
31	31
32	32
33	33
34	34
35	35
36	36
37	37
38	38
39	39
40	40
41	41
42	42
43	43
44	44
45	45
46	46
47	47
48	48
49	49
50	50
51	51
52	52
53	53
54	54
55	55
56	56
57	57
58	58
59	59
60	60
61	61
62	62
63	63
64	64
65	65
66	66
67	67
68	68
69	69
70	70
71	71
72	72
73	73
74	74
75	75
76	76
77	77
78	78
79	79
80	80
81	81
82	82
83	83
84	84
85	85
86	86
87	87
88	88
89	89
90	90
91	91
92	92
93	93
94	94
95	95
96	96
97	97
98	98
99	99
100	100

SECTION VI	Evaluation of Methods of Detecting Fires . . .	67
6.1	Single Shot Detectors	68
6.2	Products of Combustion	68
6.3	Combustible Vapors	69
6.4	Ionization Effects	69
6.5	Contact Heating Effect	70
6.6	Effects of Radiant Energy	72
6.6.1	Amount of Radiant Flux	72
6.6.2	Ratio of Radiant Intensities in Two Wavelength Intervals	81
6.6.3	The Flicker of Flames	83
6.6.4	Rate of Change in Radiant Flux	84
6.6.5	The Rate of Increase in Radiant Flux and the Flicker	88
SECTION VII	Summary	90
SECTION VIII	Recommendations	93
SECTION IX	Bibliography	95

Item	Description	Value
1
2
3
4
5
6
7
8
9
10
11
12
13
14
15
16
17
18
19
20
21
22
23
24
25
26
27
28
29
30
31
32
33
34
35
36
37
38
39
40
41
42
43
44
45
46
47
48
49
50

LIST OF ILLUSTRATIONS

Figure Number		Page
1	Spectral Radiance Curves for Bunsen Flame and Blackbody at 2200°F and Internal Transmittance of Window Materials	10
2	Flame Spectra of Three Petroleum Fuels	11
3	Section of 6" Diameter Water Cooled Constant Level Burner	15
4	Laboratory Apparatus for Flame Radiometry	16
5	Block Diagram of Radiation Analyzer	19
6	Spectroradiometer Receiver, Rear View of Interior	20
7	Schematic Diagram of Spectroradiometer	21
8	Relative Response of Radiometer	22
9	Relative Response of Radiometer	23
10	Oscillograph Record of Variations in Radiant Intensity in Five Wavelength Regions	27
11	Ratio of Energy Through Pyrex and Fluoride Windows	35
12	Ratio of Energy Through Quartz and Fluoride Windows	36
13	Ratio $N(2.6-3.8)$ to $N(0-9.5)$	37
14	Ratio $N(3.8-9.5)$ to $N(0-9.5)$	38
15	Ratio of Radiant Energy Through Pyrex and Quartz Windows	39
16	Spectral Radiance Curves for Blackbodies and Internal Transmittance Curves of Window Materials	43
17	Gasoline Diffusion Flames in 6 inch Burner	49
18	Wave Analysis of Natural Gas Diffusion Flame	51
19	Wave Analysis of Ram Jet Burner Flame	52

LIST OF TABLES

Page	Table	Page
10	General features of the system and the method of calculation of the relative response of the system	1
11	Calculation of the relative response of the system	2
11	Calculation of the relative response of the system	3
12	Calculation of the relative response of the system	4
13	Calculation of the relative response of the system	5
14	Calculation of the relative response of the system	6
15	Calculation of the relative response of the system	7
16	Calculation of the relative response of the system	8
17	Calculation of the relative response of the system	9
18	Calculation of the relative response of the system	10
19	Calculation of the relative response of the system	11
20	Calculation of the relative response of the system	12
21	Calculation of the relative response of the system	13
22	Calculation of the relative response of the system	14
23	Calculation of the relative response of the system	15
24	Calculation of the relative response of the system	16
25	Calculation of the relative response of the system	17
26	Calculation of the relative response of the system	18
27	Calculation of the relative response of the system	19
28	Calculation of the relative response of the system	20
29	Calculation of the relative response of the system	21
30	Calculation of the relative response of the system	22

Figure Number		Page
20	Wave Analysis of Gasoline Diffusion Flame	53
21	Wave Analysis of Hydraulic Fluid Diffusion Flame	54
22	Wave Analysis of Lubricating Oil Diffusion Flame	55
23	Oscillograph Record of Radiant Intensity of a Gasoline Diffusion Flame From the Time of Ignition and a 40 cps Timing Trace	57
24	Time Constant as a Function of Mass Velocity	62
25	Schematic Diagram of Flame Conduction Apparatus	65
26	Spectral Transmittance of Oil Films, Visibility, Solar Irradiance and Response of Geiger-Muller Tube	74

10	new subjects of business - 1948	10
11	new subjects of business - 1948	11
12	new subjects of business - 1948	12
13	new subjects of business - 1948	13
14	new subjects of business - 1948	14
15	new subjects of business - 1948	15
16	new subjects of business - 1948	16
17	new subjects of business - 1948	17
18	new subjects of business - 1948	18
19	new subjects of business - 1948	19
20	new subjects of business - 1948	20
21	new subjects of business - 1948	21
22	new subjects of business - 1948	22
23	new subjects of business - 1948	23
24	new subjects of business - 1948	24
25	new subjects of business - 1948	25
26	new subjects of business - 1948	26
27	new subjects of business - 1948	27
28	new subjects of business - 1948	28
29	new subjects of business - 1948	29
30	new subjects of business - 1948	30
31	new subjects of business - 1948	31
32	new subjects of business - 1948	32
33	new subjects of business - 1948	33
34	new subjects of business - 1948	34
35	new subjects of business - 1948	35
36	new subjects of business - 1948	36
37	new subjects of business - 1948	37
38	new subjects of business - 1948	38
39	new subjects of business - 1948	39
40	new subjects of business - 1948	40
41	new subjects of business - 1948	41
42	new subjects of business - 1948	42
43	new subjects of business - 1948	43
44	new subjects of business - 1948	44
45	new subjects of business - 1948	45
46	new subjects of business - 1948	46
47	new subjects of business - 1948	47
48	new subjects of business - 1948	48
49	new subjects of business - 1948	49
50	new subjects of business - 1948	50
51	new subjects of business - 1948	51
52	new subjects of business - 1948	52
53	new subjects of business - 1948	53
54	new subjects of business - 1948	54
55	new subjects of business - 1948	55
56	new subjects of business - 1948	56
57	new subjects of business - 1948	57
58	new subjects of business - 1948	58
59	new subjects of business - 1948	59
60	new subjects of business - 1948	60
61	new subjects of business - 1948	61
62	new subjects of business - 1948	62
63	new subjects of business - 1948	63
64	new subjects of business - 1948	64
65	new subjects of business - 1948	65
66	new subjects of business - 1948	66
67	new subjects of business - 1948	67
68	new subjects of business - 1948	68
69	new subjects of business - 1948	69
70	new subjects of business - 1948	70
71	new subjects of business - 1948	71
72	new subjects of business - 1948	72
73	new subjects of business - 1948	73
74	new subjects of business - 1948	74
75	new subjects of business - 1948	75
76	new subjects of business - 1948	76
77	new subjects of business - 1948	77
78	new subjects of business - 1948	78
79	new subjects of business - 1948	79
80	new subjects of business - 1948	80
81	new subjects of business - 1948	81
82	new subjects of business - 1948	82
83	new subjects of business - 1948	83
84	new subjects of business - 1948	84
85	new subjects of business - 1948	85
86	new subjects of business - 1948	86
87	new subjects of business - 1948	87
88	new subjects of business - 1948	88
89	new subjects of business - 1948	89
90	new subjects of business - 1948	90
91	new subjects of business - 1948	91
92	new subjects of business - 1948	92
93	new subjects of business - 1948	93
94	new subjects of business - 1948	94
95	new subjects of business - 1948	95
96	new subjects of business - 1948	96
97	new subjects of business - 1948	97
98	new subjects of business - 1948	98
99	new subjects of business - 1948	99
100	new subjects of business - 1948	100

ABSTRACT

This report gives the results of an investigation to determine those characteristics of flames that might be utilized in the detection of accidental fires in aircraft engine spaces and an evaluation to determine which of these might be used most advantageously in the development of a suitable fire detecting system for Air Force service.

Although, in the experimental work, emphasis was placed on the measurement of the amount of energy radiated by different flames in various parts of the spectrum and of the variations with respect to time (flicker) of these quantities, other characteristics of flames were also considered.

It was concluded that the most reliable fire detecting system for Air Force service should require both a rapid increase in the radiant flux which accompanies the initiation of a fire and the flicker that follows for an indication of fire and the absence of flicker for an indication of "fire-out".

...the ... of ...

...the ... of ...

...the ... of ...

PRINCIPLES OF FIRE DETECTION IN AIRCRAFT ENGINE SPACES

W. F. Roeser and C. S. McCamy

INTRODUCTION

The physical damage and loss of life resulting from accidental fires in aircraft in flight are of sufficient import that no further justification for taking remedial action is needed. It has been demonstrated in flights and in fire tests under simulated flight conditions that if a fire is detected within a few seconds after its initiation, it can usually be extinguished without serious damage or loss of life. It has also been demonstrated that if a fire is not detected or if a false alarm is received while an aircraft is in flight, serious consequences may result. The first step, then, toward keeping the losses from accidental fires low is to obtain only positive indications of those fires which exist and their locations at the earliest possible moment.

Fire detecting systems have been used on aircraft for a number of years, but they have not been entirely satisfactory. From the information that has come to our attention, it appears that the 3 principal reasons for dissatisfaction with the existing fire detecting systems are: (a) false alarms; (b) failure to indicate fires; and (c) long delay in indicating fire. A considerable amount of research has been carried out by the Armed Services, the Civil Aeronautics Administration, and private organizations with the objectives of improving existing systems and developing new systems. This research has not been fruitless because some of the more recently devised systems which are now undergoing "shake-down" tests in aircraft are promising and appear to have definite advantages over the older systems. Although fire detecting systems operating on widely different principles and utilizing different characteristics of fires have been and still are being devised and tried in fire tests simulating flight conditions, none of them appears, as yet, to meet satisfactorily all the requirements of the Air Force.

INTRODUCTION

The history of the United States is a story of a people who have grown from a small group of immigrants to a great nation. The story begins with the first settlers who came to the shores of North America in search of a better life. They found a land of vast resources and a people who were eager to learn from them. The story continues through the years of struggle and growth, from the days of the Pilgrims to the present. It is a story of a people who have overcome many hardships and who have built a nation that is a source of pride and inspiration to all.

The history of the United States is a story of a people who have grown from a small group of immigrants to a great nation. The story begins with the first settlers who came to the shores of North America in search of a better life. They found a land of vast resources and a people who were eager to learn from them. The story continues through the years of struggle and growth, from the days of the Pilgrims to the present. It is a story of a people who have overcome many hardships and who have built a nation that is a source of pride and inspiration to all.

The basic purposes of the present investigation were:

(1) To determine those properties, characteristics, or manifestations of flames that might be utilized in the detection of accidental fires in aircraft engine nacelles or engine compartments,

(2) To recommend to the Air Research and Development Command the method most likely to provide a suitable fire detecting system for use in aircraft based upon the technical feasibility of development, the volume and weight of the necessary equipment, the speed of response in detection of fires and in signaling "fire-out" after extinguishment, and the freedom from false alarms when subjected to the environmental and operational conditions encountered in Air Force Aircraft in world-wide operations; and

(3) To report to the Air Research and Development Command any observations or factors found that might be pertinent to the development of any fire detecting system.

The first component of the present investigation was:

(1) To determine the effect of the amount of time spent in the laboratory on the amount of time spent in the field. The amount of time spent in the laboratory was measured in terms of the number of hours spent in the laboratory. The amount of time spent in the field was measured in terms of the number of hours spent in the field.

(2) To determine the effect of the amount of time spent in the laboratory on the amount of time spent in the field. The amount of time spent in the laboratory was measured in terms of the number of hours spent in the laboratory. The amount of time spent in the field was measured in terms of the number of hours spent in the field.

(3) To determine the effect of the amount of time spent in the laboratory on the amount of time spent in the field. The amount of time spent in the laboratory was measured in terms of the number of hours spent in the laboratory. The amount of time spent in the field was measured in terms of the number of hours spent in the field.

SECTION I

OPERATING PRINCIPLES OF FIRE DETECTORS

1.0 Since one of the purposes of the investigation was to recommend a method most likely to provide a suitable fire detecting system, a literature review was made to obtain information on (1) the advantages and limitations of the various methods that have been used and proposed for use in the detection of fires in aircraft and (2) the various characteristics and effects of flames. The review covered books, periodicals, patents, and available technical reports.

The various methods used and proposed for fire detection in aircraft have been classified below in accordance with the flame characteristic or effect which causes the detector to operate. These have been subdivided further into types of detectors depending upon the physical principle utilized in the operation of the detector. The extent of coverage provided by the various types of detectors is referred to as unit or "point", continuous or "line" or in the case of those which monitor all parts of a given space, "space" type.

A few of the methods described in the literature were obviously impracticable, and have not been listed. On the other hand, some suggested methods not found in the literature have been included.

1.1 Igniting Effect

Probably the oldest method of detecting fire depended upon the ability of a flame to ignite certain combustible materials, the burning of which triggered or actuated an alarm. Examples are the burning of a cord which actuates a switch in an electric circuit and the burning of a fuse or wick which initiates a detonation. Detectors operating upon this principle have been of the unit type. [1,2,3,6,36]^a

1.2 Contact Heating Effect

The ability of a flame to heat an object by contact to a pre-determined temperature level or at a rate greater than that encountered in normal operation has been used in far more different types of fire detectors than any other characteristic of a flame. It

^a Numbers in brackets indicate the references at the end of this report.

appears that almost every readily measurable physical property of a material that changes significantly with temperature has been proposed for use in fire detectors. A number of both unit and continuous type detectors operating on this characteristic of a flame have been developed.

1.2.1 Predetermined Temperature Level

Detectors operating upon this general principle actuate an alarm when the temperature of a sensitive element is raised to some predetermined value which is set by an adjustment of the element or is an inherent property of the material composing the element.

1.2.1.1 Differential Thermal Expansion of Solids

The temperature sensitive element of this type of detector consists of 2 materials which have different coefficients of expansion. The elements of the 2 materials are so constructed that an alarm circuit is actuated when they are heated to a predetermined temperature. Some types are provided with an adjustment that permits altering the temperature at which the alarm is actuated. These devices are usually relatively small, in which case they are of the unit type /1,2,3,5,11,12,13,14/, but they may be elongated into a continuous type /5/.

1.2.1.2 Melting of Solids

In detectors of this type, the temperature sensitive element, which actuates the alarm system, consists of a metal, alloy, wax, or salt that melts at a temperature which is somewhat higher than that attained in normal operation. The melting temperature is an inherent property of the material used. Detectors operating on this principle may be either of the unit /3,6,36/ or the continuous type /1,2,3,8/.

1.2.1.3 Change in Electrical Resistance

The temperature sensitive element of detectors of this type consists of 2 metallic electrical conductors separated by a thermistor type material, the resistance of which changes significantly with temperature. The alarm system is actuated when the resistance between the 2 metallic conductors reaches some predetermined value. Detectors operating on this principle are usually of the continuous type. /5,15,16/.

1.2.1.4 Expansion of Fluids

The temperature sensitive element in detectors of this type consists of a liquid, vapor, or a gas in a closed container. The

...the ... of ...
...the ... of ...
...the ... of ...

1.1.1.1. ...

...the ... of ...
...the ... of ...
...the ... of ...

1.1.1.2. ...

...the ... of ...
...the ... of ...
...the ... of ...

1.1.1.3. ...

...the ... of ...
...the ... of ...
...the ... of ...

1.1.1.4. ...

...the ... of ...
...the ... of ...
...the ... of ...

1.1.1.5. ...

...the ... of ...
...the ... of ...
...the ... of ...

alarm system is actuated by the change in pressure that accompanies a change in temperature. Detectors of this type may be either the unit [7,9,10] or the continuous type [5,10].

1.2.1.5 Thermoelectric

In this proposed type of detector, the temperature sensitive element would consist of a thermocouple with one junction exposed in the fire area. The other junction would be located at a control unit where compensation could be made for variation in the ambient temperature. The alarm system would be actuated by the change in the emf in the thermocouple circuit resulting from a change in the temperature of the exposed junction. Detectors operating on this principle would be of the unit type. [36].

1.2.1.6 Curie Temperature

Detectors of this type would employ, as a temperature sensitive element, a ferromagnetic material with a curie temperature higher than any temperature encountered in normal operation. The alarm system would be actuated by the change in the magnetic permeability of the ferromagnetic material when it is heated or cooled through the curie temperature. Detectors operating on this principle could be of either the unit [17], or the continuous type [18].

1.2.1.7 Fusible Electrolytes

The temperature sensitive element of this type of detector would be 2 metallic electrodes separated by a salt in the solid state at normal operating temperatures. If the temperature were raised above its melting point, it would become an active electrolyte and with the 2 electrodes would form a galvanic cell. An alarm system could be actuated by the cell. It might be either of the unit or continuous type. It is possible that a detector operating on this principle would not require any other power supply. [37].

1.2.2 Rate of Temperature Rise

Detectors operating upon this principle actuate an alarm when the rate of temperature rise of a temperature sensitive element is greater than some predetermined rate established by the maximum rate of temperature rise that might be attained in normal operation.

... ..
... ..
... ..

... ..

... ..
... ..
... ..
... ..
... ..
... ..
... ..
... ..
... ..
... ..
... ..

... ..

... ..
... ..
... ..
... ..
... ..
... ..
... ..
... ..
... ..
... ..
... ..

... ..

... ..
... ..
... ..
... ..
... ..
... ..
... ..
... ..
... ..
... ..
... ..

... ..

... ..
... ..
... ..
... ..
... ..
... ..
... ..
... ..
... ..
... ..
... ..

1.2.2.1 Thermoelectric

The temperature sensitive element of this fire-detecting system consists of a number of thermocouples connected in series. One junction of each thermocouple is exposed in the fire area while the other is thermally lagged. If the rate of temperature rise is relatively slow, as in normal operations, the temperature difference between the 2 sets of junctions is not great enough to generate an appreciable emf, but if flames contact the exposed set of junctions, the temperature difference between the 2 sets of junctions becomes great enough to generate sufficient emf in the thermoelectric circuit to actuate an alarm. Detectors operating on this principle are of the unit type. 5,6,12,13,19

1.2.2.2 Expansion of Air

The temperature sensitive element of detectors of this type consists of air in a system that is closed except for a restricted opening. During normal rates of heating, the expanding air escapes through the restricted opening without building up a very great pressure, whereas an abnormally high rate of heating will generate sufficient pressure in the system to actuate an alarm. Detectors operating on this principle may be of either the unit 9 or continuous type 5.

1.2.2.3 Thermal Expansion of Solids

The differential thermal expansion type of fire detectors, mentioned in section 1.2.1.1, can be made to operate also upon the rate of temperature rise by thermally lagging one of the materials composing the temperature sensitive element. In general, detectors of this type operate on either the temperature level or the rate of temperature rise. They may be either of the unit 1,6,12,13,21 or the continuous type 5.

1.2.2.4 Electrical Resistance

The temperature sensitive element of this type of fire detector would consist of 2 resistors with an appreciable temperature coefficient of resistance, connected in a bridge circuit. One resistor would be exposed in the fire area and the other would be thermally lagged. An abnormally rapid rate of temperature rise in the fire area would unbalance the bridge circuit sufficiently to actuate an alarm.

1.3 Effects of Radiant Energy

All the different types of detectors mentioned in the preceding sections were of the unit or continuous type and depended upon the flame contacting an element. A detector operated by the energy radiated by a flame has a definite advantage in that a single unit can monitor a relatively large space. Although all flames radiate energy, this characteristic of a flame has not been utilized, until relatively recently, in fire-detecting systems on aircraft, primarily because of the difficulty in distinguishing the energy emitted by the flames from that by the background. The characteristics of the radiant energy emitted by flames are grouped into the following categories.

1.3.1 Radiant Flux (Radiant Energy per unit of time.)

One method of detecting the presence of a flame in a given space would be to utilize the quantity of the radiant flux, received by a detector viewing the space. The detector could be made to respond to the radiant energy in selected wavelength bands by providing it with suitable filters. One type of detector that has been proposed responds only to the radiant energy at wavelengths less than 0.29 micron, a range in which there would be no solar or background radiation. [22,23,24]. Another type of detector which has been proposed would be highly responsive to the radiant energy between 4 and 5 microns, where the strong CO₂ emission band of hydrocarbon flames exists.

1.3.2 Rate of Change in Radiant Flux

Since an accidental fire in an aircraft engine compartment breaks out almost instantly, there is a very rapid increase in the quantity of the radiant flux from the space in which the fire starts. The rate of increase in the radiant flux received by a detector viewing this space could be used to actuate an alarm. It would be necessary to adjust the circuitry so that a false alarm would not be given by the slower rate of increase in the radiant flux from the engine parts. As mentioned in the previous section, it might be advantageous to utilize the radiant energy in selected wavelength regions in order to facilitate in distinguishing between the radiant energy from a fire and that from the background.

1.3.3 Ratio of Radiant Intensities in Two Wavelength Intervals

The spectral distribution of the radiant energy from a flame is, in some respects, different from that of a continuous radiator. A fire detector which utilizes the ratio of radiant intensities of the flame in 2 selected wavelength intervals has been proposed. [12,13]

1.3.4 Variations in Radiant Flux

The radiant flux emitted by a flame depends upon such factors as its temperature, its size, its movements, the degree of aeration, etc., which vary rapidly and to some extent periodically with time. Although the radiant flux from the background in an aircraft engine compartment also varies with time, it is usually at a much lower rate and non-periodic. Thus, a device that will respond only to the rapid, periodic variations in the radiant flux from flames should distinguish between the radiation from flames and that from the background.

1.3.4.1 Flicker

One method of detecting the periodic "flicker" of flames utilizes photosensitive detectors and filter circuits. A considerable degree of success has been attained with such detecting systems. [4,5,25,26,27,28].

1.3.4.2 Waver

Some flames have a tendency to oscillate or waver from side to side. A photoelectric device claimed to respond either to this effect or to flicker, has been proposed as a fire detector. [28].

1.4 Ionization Effects

An abnormally high ionization exists in the reaction zones of hydrocarbon flames. This flame characteristic has been utilized in devices for monitoring the presence of pilot lights in boilers and has been proposed as an operational principle for fire detectors.

1.4.1 Flame Conductivity

If sufficiently separated in air, no current will flow between two electrodes with a potential difference between them, but if a flame contacts both electrodes a current will flow since the products in the reaction zone of the flame are ionized. This electric current may be utilized to actuate an alarm. [1,29].

1.4.2 Flame Rectification

When a flame contacts two electrodes of unequal area, the electric current will flow more readily in one direction than the other. This principle, with suitable electrodes and circuitry, has been used in the detection of flames. [2,3,13,30,31].

The first part of the report is a general survey of the situation in the country, and a description of the progress of the work during the year. It is followed by a detailed account of the various projects and experiments carried out, and a summary of the results obtained. The report concludes with a list of references and a table of contents.

178

The second part of the report is a detailed account of the various projects and experiments carried out during the year. It is divided into several sections, each dealing with a different aspect of the work. The first section is devoted to the study of the properties of the various materials used, and the second to the study of the various processes employed.

179

The third part of the report is a summary of the results obtained during the year. It is divided into several sections, each dealing with a different aspect of the work. The first section is devoted to the study of the properties of the various materials used, and the second to the study of the various processes employed.

180

The fourth part of the report is a list of references and a table of contents. The references are given in full, and the table of contents is given in full. The report is printed in the English language, and is available in both hard copy and electronic form.

181

The fifth part of the report is a list of references and a table of contents. The references are given in full, and the table of contents is given in full. The report is printed in the English language, and is available in both hard copy and electronic form.

182

The sixth part of the report is a list of references and a table of contents. The references are given in full, and the table of contents is given in full. The report is printed in the English language, and is available in both hard copy and electronic form.

1.4.3 Acoustic Attenuation

Since the products in the reaction zone of a flame are ionized, they absorb and scatter radio waves, very high frequency electromagnetic waves. The attenuation of electromagnetic signals by flames has been suggested as a method of detecting the presence of flames in a navigable.

1.5 Effects of Combustion Products

The absorption of light energy from combustion products characteristic products into the surrounding atmosphere. Methods of detecting these products when they are present in amounts greater than those normally in air have been devised and proposed for the detection of fires.

1.5.1 CO₂ Analysis

The major products of combustion of hydrocarbon fuels in air are carbon dioxide and water vapor. Carbon monoxide may be produced also if there is a deficiency of oxygen. Since water vapor is always present in air in varying amounts, its presence in the atmosphere in any appreciable amount is not a positive indication of a fire. The presence of a relatively high concentration of CO₂ in the atmosphere is usually a positive indication of a fire.

1.5.2 Smoke

The optical scattering power and the reflectance of the atmosphere is increased and the transmission is decreased by the presence of smoke. This principle is utilized in many systems for detecting smoke, which, according to smoke, is evidence of fire. (2, 3, 4)

1.5.3 Stellar Effect

If ultrasonic compressional waves are introduced into a space in which flames, smoke, and hot gases are in motion, the frequency of the reflected waves will be different from that of the waves introduced. This Doppler shift has been proposed as a means of detecting fires in rather large spaces of navigable space. (5)

1.6 Detection of Combustible Vapor

Although this is a method of detecting flames, it would, if developed, be a method of preventing fires. It is not devised for detecting combustible vapors, whether of the atmosphere in the space to be monitored is passed over a hot wire. The increase in the resistance of the wire resulting from combustion of the vapors gives a measure of the amount of combustible vapor in the atmosphere.

The first part of the report is devoted to a general description of the country and its resources. It is found that the country is well adapted for agriculture and stock raising.

SECTION II

The second part of the report contains a detailed description of the principal occupations of the people. It is found that agriculture is the principal occupation of the people.

SECTION III

The third part of the report contains a description of the principal cities and towns of the country. It is found that the principal cities and towns are well situated for commerce and industry.

SECTION IV

The fourth part of the report contains a description of the principal rivers and streams of the country. It is found that the principal rivers and streams are well adapted for navigation and commerce.

SECTION V

The fifth part of the report contains a description of the principal mountains and hills of the country. It is found that the principal mountains and hills are well adapted for agriculture and stock raising.

SECTION VI

The sixth part of the report contains a description of the principal lakes and ponds of the country. It is found that the principal lakes and ponds are well adapted for navigation and commerce.

SECTION II

FLAME EFFECTS INVESTIGATED

Since most of the fire detecting systems, that have been proposed depend upon the flames contacting a temperature sensitive element, more studies have been made of systems operating on this principle than on any other. Although they have been found to be satisfactory in many respects, there is no assurance that the flames will always contact the temperature sensitive element. This limitation is not encountered with detecting systems which depend upon the radiant energy from the flames for their operation. In addition, limited tests with systems which depend upon the radiant energy indicate that they respond much more rapidly than those which depend upon flame contact. Consequently, the major part of the present work was devoted to studies of the radiant energy from flames. However, some study was made of the contact heating effects by flames and the ionization in flames.

In addition to the above studies of flame effects, a few experiments were performed to obtain the information necessary to evaluate properly some of the proposed fire detecting systems.

THE HISTORY OF THE

The first part of the history of the world is the history of the human race. It is a story of progress and struggle, of triumph and defeat. It is a story of the human mind and the human heart, of the human spirit and the human soul. It is a story of the human race as a whole, and of the human race in each of its parts. It is a story of the human race as it is, and of the human race as it should be. It is a story of the human race as it has been, and of the human race as it will be. It is a story of the human race as it is, and of the human race as it should be. It is a story of the human race as it has been, and of the human race as it will be.

The second part of the history of the world is the history of the human mind. It is a story of the human mind as it is, and of the human mind as it should be. It is a story of the human mind as it has been, and of the human mind as it will be. It is a story of the human mind as it is, and of the human mind as it should be. It is a story of the human mind as it has been, and of the human mind as it will be.

SECTION III

RADIATION EFFECTS

3.0 The differences in color observed in various flames and in the different parts of the same flame indicate, to some extent, the variations in the spectral nature of the energy radiated by flames. Similar variations in the spectral nature of the energy radiated also occur in the infrared portion of the spectrum which includes, by far, the major portion of the energy radiated by hydrocarbon flames. Because of these variations it is not possible to assign, accurately, any one value to the amount of energy radiated by a flame in any particular part of the spectrum. However, since we were concerned here with the detection of accidental fires, it appeared advisable to establish the range over which the amount of energy radiated in various parts of the spectrum might vary.

The flames produced by burning fuel of any given type radiate selectively in certain wavelength bands which are determined by the composition of the fuel. Since most of the fuels that constitute a fire hazard in aircraft engine compartments are basically hydrocarbons, they will produce flames that have the same general radiation characteristics as any other hydrocarbon flame. The wavelength bands in which hydrocarbon flames radiate selectively are most readily determined with non-luminous flames in which complete combustion takes place.

A typical emission spectrum of a non-luminous bunsen flame is shown in Fig. 1. The strongest emission band at around 4.4 microns is due to the emission by carbon dioxide molecules. The next most pronounced band at around 2.8 microns is attributed largely to carbon dioxide and to some extent to water vapor. There are other small bands near 0.95, 1.45 and 2. microns. Although emission bands and lines have been observed at wavelengths out to 20 microns and beyond, most of the energy emitted by such flames is at wavelengths less than 7 microns [41].

There are also emission bands and lines in the ultraviolet and visible portions of the spectrum. Since the relative magnitude of these are not sufficiently great to show on the scale used in Fig. 1, they are reproduced from photographs in Fig. 2. The similarity among the emission spectra for 3 different hydrocarbon fuels is shown here. It is seen that flames of this type emit a small amount of radiant energy at wavelengths less than 0.29 micron. The radiation from flames in this wavelength region has been of particular interest in flame detection because practically all of the radiant energy from the sun below 0.29 micron is absorbed in the upper atmosphere of the earth.

THE HISTORY

OF THE

The history of the world is a vast and complex subject, encompassing the lives and actions of countless individuals and the events that have shaped our planet. From the dawn of civilization to the present day, the human story is one of constant change and evolution. This work seeks to explore the major forces that have driven the course of history, from the rise of empires to the fall of nations, and from the discovery of the Americas to the challenges of the modern world. It is a journey through time, a quest for understanding of the human condition and the path we have traveled together.

In the early days of the world, the first humans emerged from the forests and savannas of Africa, beginning a long and arduous journey across the globe. They learned to use tools, to hunt, and to cooperate with one another, laying the foundation for the societies that would follow. The discovery of fire, the invention of the wheel, and the development of writing were milestones that marked the beginning of a new era. As civilizations grew, they became more complex and more powerful, but they also faced new challenges and dangers. The rise and fall of empires, the spread of religions, and the discovery of the Americas were all part of the grand tapestry of human history.

The world has come a long way since those early days, and the challenges we face today are more complex and more daunting than ever before. The discovery of the Americas, the rise of the industrial revolution, and the challenges of the modern world have all shaped the course of human history. We have made great strides in our understanding of the world and ourselves, but we still have much to learn. The future is uncertain, but it is also full of potential. It is up to us to shape the world we live in, to create a better future for ourselves and for the generations to come.

The history of the world is a story of hope and resilience, of the human spirit's ability to overcome adversity and to create a better world. It is a story of the triumph of the human mind and the power of human cooperation. We have come a long way, and we have much to be proud of. But we must not forget the challenges that lie ahead. We must continue to learn, to grow, and to strive for a better future. The history of the world is not just a record of the past, it is a guide to the future. It is a story that we must all share, a story that we must all live.

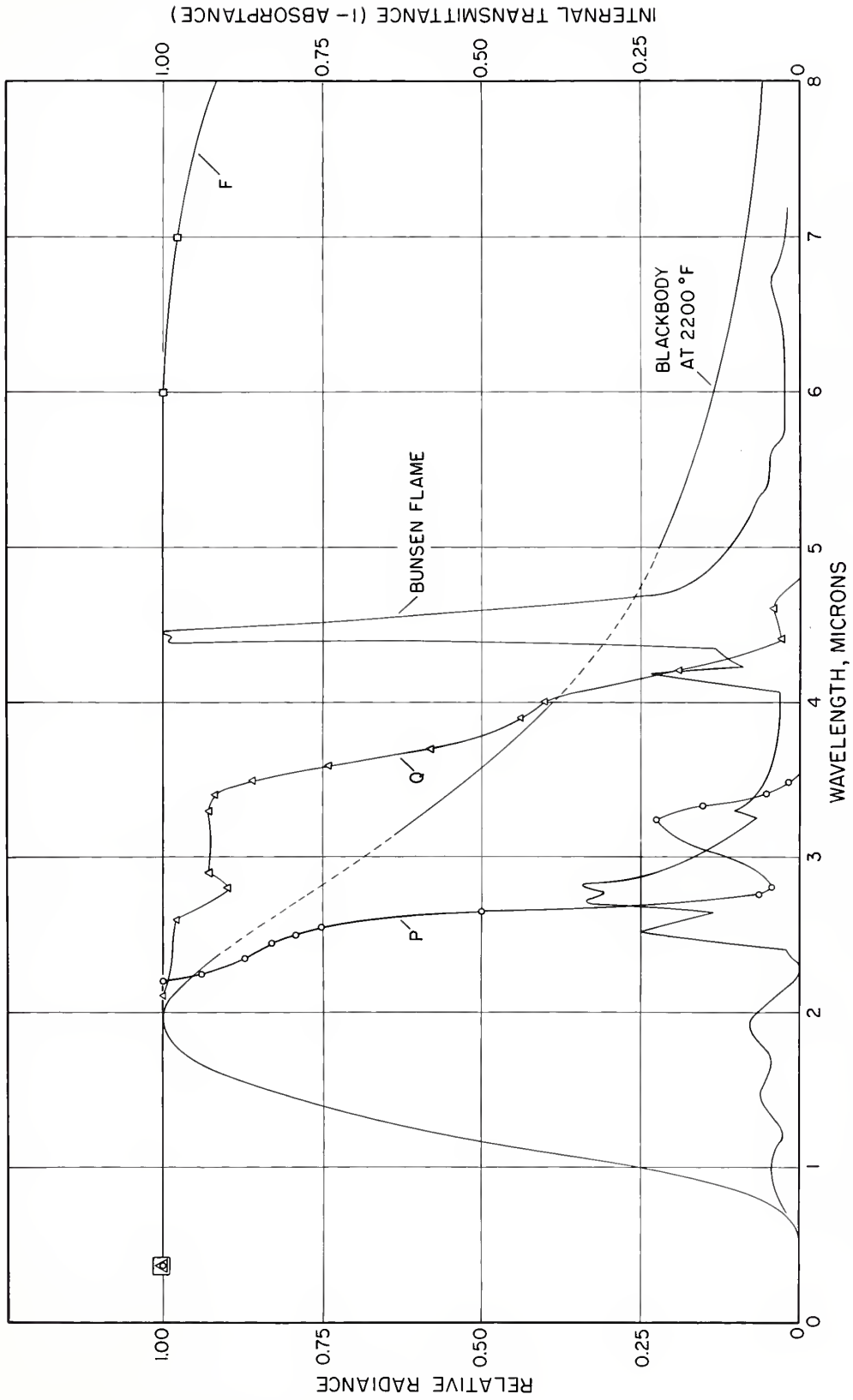

FIG. 1 SPECTRAL RADIANCE CURVES FOR BUNSEN FLAME AND BLACKBODY AT 2200°F AND INTERNAL TRANSMITTANCE OF WINDOW MATERIALS

24161

1

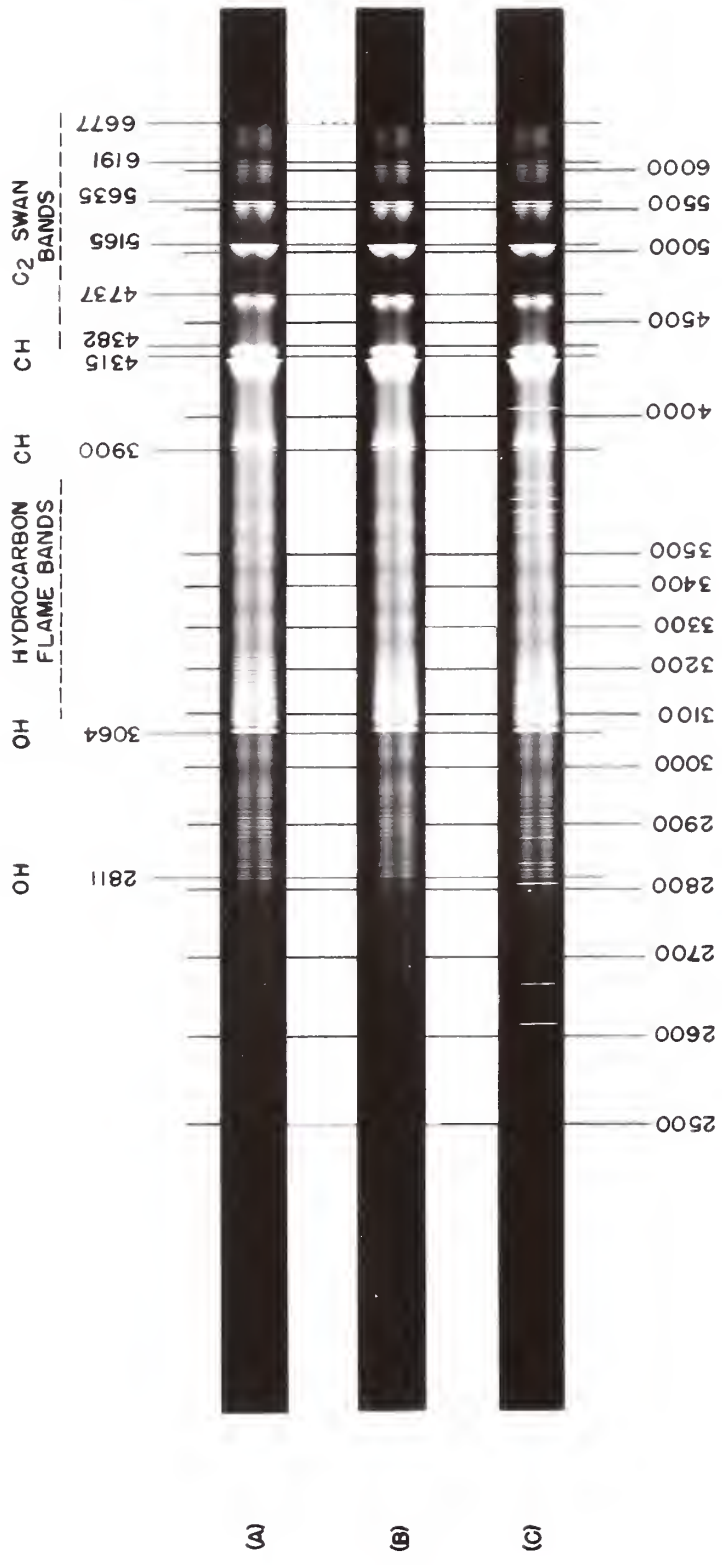

FIG.2 FLAME SPECTRA OF THREE PETROLEUM FUELS

- (A) UNLEADED MARINE GASOLINE
- (B) GRADE JP-4 FUEL (MIL-F-5624A)
- (C) GRADE 100/130 FUEL (MIL-F-5572)
EXTRA LINES ARE DUE TO LEAD

22551

22551

The flame reaction products to which the respective emission bands are attributed are shown in the figure. The relative strength of the CH band at about 0.431 micron, compared to that of the bands at longer wavelengths, accounts for the blue color of hydrocarbon flames in which nearly complete combustion takes place.

In order to have nearly complete combustion, the condition under which the above mentioned emission bands are most readily observed, it is necessary to premix the fuel and air. Such flames are called "premixed flames". If a flame is formed by air supplied to the fuel by diffusion and mixing with the surrounding atmosphere, the flame is called a "diffusion flame". Diffusion flames have received much less attention than premixed flames in fundamental research, despite the fact that diffusion flames are more frequently used industrially and are the more common in accidental fires. The primary reason for this lack of interest in the study of diffusion flames is that they are extremely variable and greatly influenced by uncontrollable factors which make it difficult to measure, accurately, any fundamental property of the flame.

The rate of mixing of the fuel and air in the reaction zone of diffusion flames is insufficient to prevent the formation of free carbon particles which, being heated in the flame, emit radiant energy. The spectral distribution of the energy radiated by these particles is similar to that of any other solid in that it is continuous in nature and depends upon the temperature. (See blackbody curves in Figs 1 and 16) The radiant energy from the characteristic flame emission bands, particularly those in the visible and ultraviolet parts of the spectrum, is almost, if not entirely, obscured by the radiant energy from and the scattering by the carbon particles. Thus, the color of diffusion flames appears red, orange or yellow.

Unless provisions are made for obtaining nearly complete combustion, part of a flame may have the characteristics of a premixed flame while another part of the same flame may have the characteristics of a diffusion flame. Thus, one part of a flame may be blue while another part is yellow or orange.

The first section of the report deals with the general situation of the country and the progress of the work done during the year. It is followed by a section on the work done in the various departments and a section on the work done in the various branches of the service.

The second section of the report deals with the work done in the various departments and branches of the service. It is followed by a section on the work done in the various departments and a section on the work done in the various branches of the service.

The third section of the report deals with the work done in the various departments and branches of the service. It is followed by a section on the work done in the various departments and a section on the work done in the various branches of the service.

The fourth section of the report deals with the work done in the various departments and branches of the service. It is followed by a section on the work done in the various departments and a section on the work done in the various branches of the service.

3.1 Amount of Radiant Flux

It was pointed out in the preceding section that the rate at which energy is radiated by a flame in any part of the spectrum varies greatly with the burner design and the degree of aeration of the flame; and, in general, it varies from one part of a flame to another. Information on the magnitude of these variations are essential to the design and development of any fire detecting system utilizing the rate of energy emission because, for any detecting system to be practical, it must detect the fire that gives the weakest signal and yet, not be made inoperative by the fire that gives the greatest signal. Realizing that the rate of energy emission from some flames might be very low, it was decided to measure the rate of energy emission over relatively wide wavelength bands because it was felt that sufficient energy to operate a practical device for use on aircraft might not be emitted in a narrow wavelength band. As a consequence, no attempt was made to determine the detailed emission spectrum of any particular flame.

The characteristic spectral emission curve for a bunsen flame, shown in Fig. 1, is a composite of the curves given by Plyler [41] and Gaydon [39]. The fine structure reported by Plyler has been omitted. Also given in Fig. 1 are transmittance curves for calcium fluoride (F), fused silica (quartz) (Q), and pyrex (P) windows or lenses, approximately 5 mm thick. Practically all the energy radiated by the flame is within the region in which calcium fluoride has a high transmission. The transmission limits of quartz and pyrex are at about 3.8 and 2.6 microns, respectively. Thus, with these 3 commercially available materials, the radiant energy out to about 10 microns (the approximate transmission limit of calcium fluoride) can be determined in 3 wide wavelength bands. Also given in Fig. 1 is the spectral emission curve for a blackbody at 2200°F. It will be pointed out later that this curve, with the possible exception of the dotted parts, will approximate the spectral emission from a diffusion flame.

It should be pointed out that the radiance values, shown in Fig. 1 are relative and have been adjusted so that the maximum value of each curve is unity. The absolute values of the maxima for the two curves might be quite different.

Since some fire detecting systems which operate on relatively narrow spectral bands in the wavelength region below 2.5 microns have been proposed studies were made on five contiguous wavelength bands in this region.

3.1.1 Burners and Fuels

Since the fundamental emission characteristics of all hydrocarbon flames appear to be essentially the same and since gas flames can be conveniently adjusted to provide different types of flames, two natural gas burners were used in the development of the methods of instrumentation. One was an ordinary Bunsen burner. The other, shown at A in Fig. 4, consisted of a long vertical pipe with a burner tip, 1 13/16 inches in diameter, an air blower, an adjustable premixer, and flow meters for both gas and air.

Two ram-jet type burners of rectangular cross-section were used to provide premixed flames from liquid fuels. Jet burner No. 1 was 1 in. wide and 3 in. high with a horizontal flame holder at mid-height. Jet burner No. 2 was 4 in. wide and 2.5 in. high with a vertical flame holder at mid-width. Facilities were available for burning various preheated homogeneous mixtures of different fuels and air and for injecting liquid fuel into preheated air. The fuels used in the jet burners were 80 octane gasoline, 100/130 aviation gasoline, and JP-4 jet engine fuel. The following ranges of operating conditions were obtained:

Fuel-air ratio ---- 0.045 to 0.111
Rate of Fuel Consumption ---- 2.0 to 6.6 lb/min
Premixture Temperature ---- 291° to 409°F
Premixture Velocity ---- 133 to 397 ft/sec

Open containers were used as burners to obtain diffusion flames from the various liquid fuels. A sectional drawing of the burner used in most of the work is shown in Fig. 3. The side walls and the baffle plate were of 1/16 in. stainless steel. The liquid fuel was introduced through an inlet in the water cooled brass bottom. The liquid level was automatically maintained at a level about 0.5 in. from the top. The fuels used in this burner were 80 octane gasoline, 100/130 aviation gasoline, nos. 1010 and 1100 lubricating oil, and petroleum base hydraulic fluid, Mil. Spec. G-5606. A 30 in. fan was used to produce air speeds up to 20 mph at the burner.

Some measurements were made on large diffusion flames produced by igniting one gallon of gasoline which had been poured into a shallow 4 ft square concrete pit.

The first paragraph of the document discusses the general situation of the country and the need for a comprehensive plan. It mentions the economic challenges and the importance of a unified approach to development.

The second paragraph details the specific measures and policies proposed for the coming year. It outlines the goals for agricultural production, industrial growth, and social welfare.

The third paragraph is a central statement or declaration, likely a key objective or a guiding principle of the plan.

The fourth paragraph provides further details and elaboration on the policies mentioned in the second paragraph. It discusses the implementation strategies and the expected outcomes.

The fifth paragraph concludes the document with a final statement or a call to action, emphasizing the commitment to the plan and the future of the country.

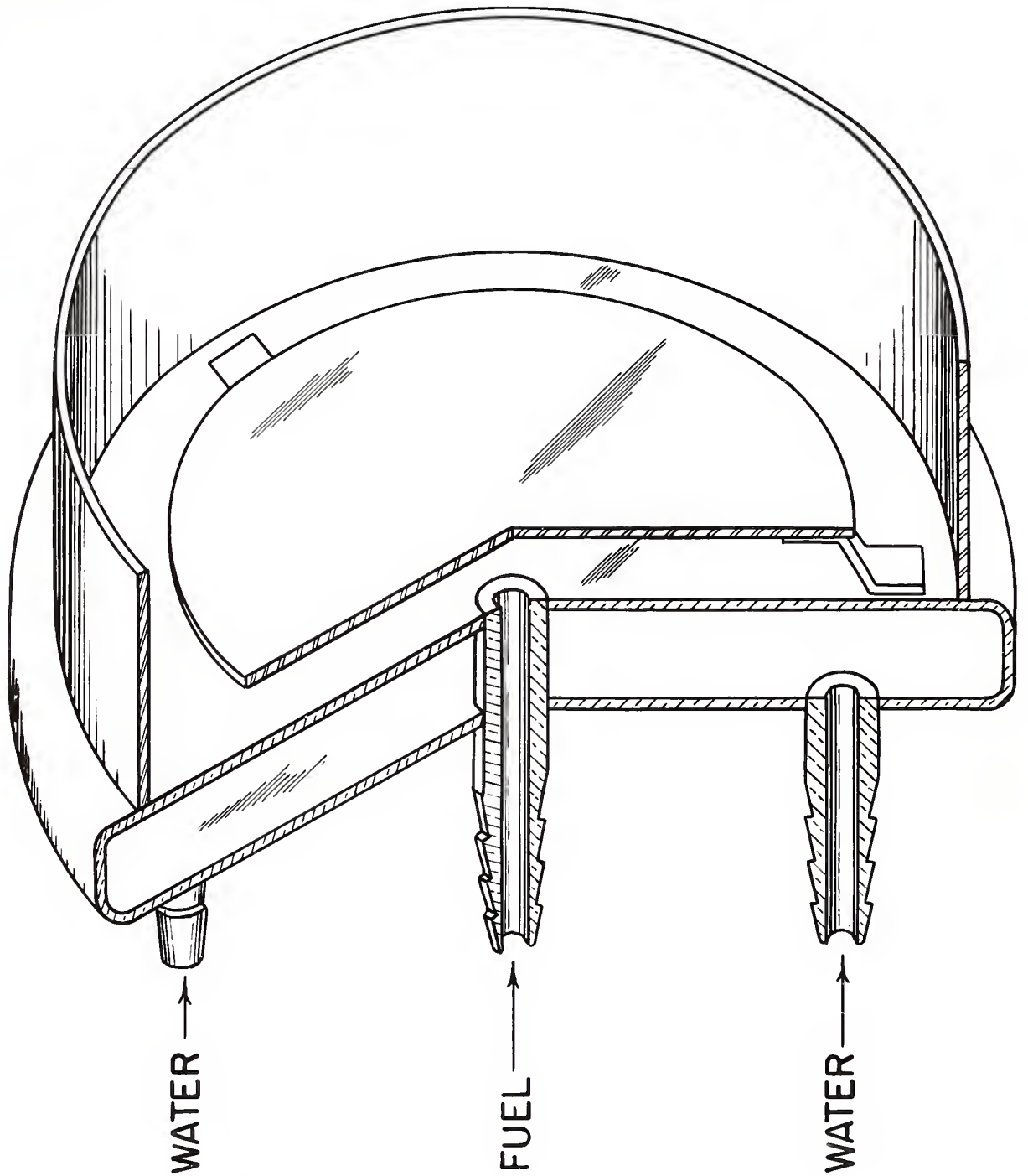

FIG.3 SECTION OF 6" DIA. WATER COOLED
CONSTANT LEVEL BURNER

1-10-1912

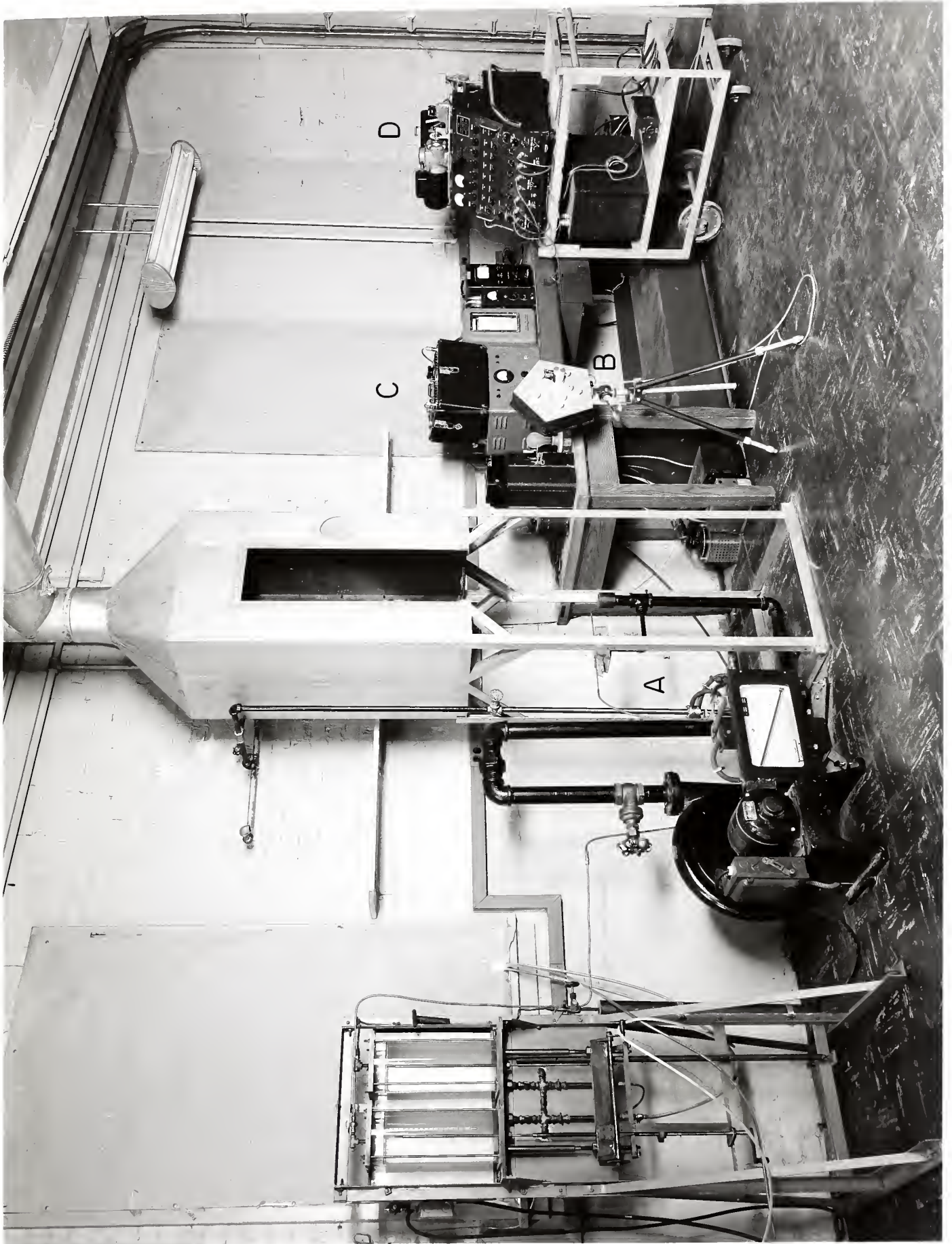

FIG. 4 LABORATORY APPARATUS FOR FLAME RADIOMETRY

23594

2

3.1.2 Apparatus and Procedure

3.1.2.1 Thermoelectric Radiation Receiver

The rate of energy emission from the various flames in 3 wavelength regions out to 2.6, 3.8, and 9.5 microns was determined by comparison with that from a blackbody. A thermoelectric lens type radiation receiver, used commercially in a radiation pyrometer, was employed as the comparator. A source 2.7 cm in diameter at a distance of 50 cm was sufficient to fill the field of the receiver. The wavelength region covered in any particular case was fixed by the lens or window material used, calcium fluoride, quartz, or pyrex. The transmittance curves of the 3 materials used are shown in Figs 1 and 16. The effective wavelength cutoff (λ_e) for each material used was calculated from the transmittance curves and the radiant energy distribution of a blackbody radiator at various temperatures. This was done by setting

$$\int_0^{\infty} \frac{I_{\lambda}}{\lambda} d\lambda = \int_0^{\lambda_e} \frac{I_{\lambda}}{\lambda} d\lambda$$

and determining λ_e . In the above equation

λ is the wavelength.

I_{λ} is the radiance of the blackbody.

and τ_{λ} is the internal transmittance.

The values for the effective wavelength cutoff of the calcium fluoride (λ_F) ranged from 9.63 microns at 300°F to 9.50 microns at 1800°F; that for the quartz (λ_Q) ranged from 3.90 microns at 300°F to 3.75 microns at 1800°F; and that for pyrex (λ_P) ranged from 2.65 microns at 300°F to 2.61 microns at 1800°F. The effective wavelength cutoffs of these materials for the radiant energy from flames can be determined only if the spectral emission curve is known. However, for most flames, it would not be very different from the values given above.

From calibrations with a blackbody radiator and the transmittance curves, it was found that the receiver developed 2.73 millivolts for each watt/(cm²-steradian) radiated by the blackbody within the wavelength band transmitted by the window material. As far as could be determined, this value was independent of the spectral distribution of the source and the incident flux density. Since the rate of energy emission from the flames varied with time because of the fluctuating nature of flames, the output of the receiver was automatically recorded for several seconds. In the case of the diffusion flames in which the fluctuations were greater than those of the premixed flames, this process was repeated at a different time. Each value reported herein is the average value determined from these records.

1917

The first of the year was a very successful one for the school. The students showed a marked improvement in their work and the teachers were very pleased with the results. The school was well attended and the students were very happy. The year was a very successful one for the school.



The second of the year was also a very successful one. The students continued to improve in their work and the teachers were very pleased with the results. The school was well attended and the students were very happy. The year was a very successful one for the school.

The third of the year was also a very successful one. The students continued to improve in their work and the teachers were very pleased with the results. The school was well attended and the students were very happy. The year was a very successful one for the school.

3.1.2.2 Spectroradiometry From 0.235 to 2.5 Microns

The experimental work on the rate of emission from the various flames in 5 different wavelength regions from 0.235 to 2.5 microns was carried out with a multiple purpose optical and electrical system designed and constructed for this particular work. A block diagram of this system, which may be designated as a recording abridged spectroradiometer or a radiation analyzer, is shown in Fig. 5. The principal component of the system was the receiver which comprised the detectors and the optical filters to isolate the wavelength regions. A front view of the receiver is shown at B in Fig. 4 and a rear view of the interior of the receiver is shown in Fig. 6. The enclosure of the receiver was "light tight" except for the 5 apertures which admitted radiant energy through the filters to the detectors. The apertures were arranged to be as close together as construction would permit, so that the flame was viewed from approximately the same direction by all of them. The spectral range of the radiant energy admitted to each detector was limited by an optical filter. The five regions covered the spectrum from 0.235 to 2.5 microns without significant overlapping, as shown in Figs 8 and 9, where the relative response of each detector with its filter is shown. All of the detectors were R.C.A. type 1P28 photomultiplier tubes except the one used for the infrared region, which was a Kodak Ektron, Type I, lead sulfide photoconductive cell with a 4x4 mm sensitive area. The filters used for the various wavelength regions are described below.

1. The region of shortest wavelengths was the ultraviolet region from 0.235 to 0.290 micron. No common phototube was available for shorter wavelengths, and since practically all radiant energy at wavelengths below 0.165 micron is absorbed in a short distance in air, shorter wavelengths were not considered. The region just below 0.290 micron was of interest because detectors of energy of these wavelengths would not be affected by energy from the sun, such radiant energy being absorbed in the earth's upper atmosphere.

It was necessary to develop a filter to isolate this spectral region. The filter devised was a combination of three liquid solutions and a glass type filter. The solutions were contained in absorption cells of the kind used in chemical spectrophotometry. The cells had windows of fused silica. The first cell was two centimeters in length and was filled with an aqueous solution containing 30 grams of nickel sulfate in 100 milliliters of solution. The second cell was one centimeter in length and contained a solution of 5×10^{-5} molar 4,4-diaminobenzophenone in 0.001 normal sodium hydroxide. The third cell was

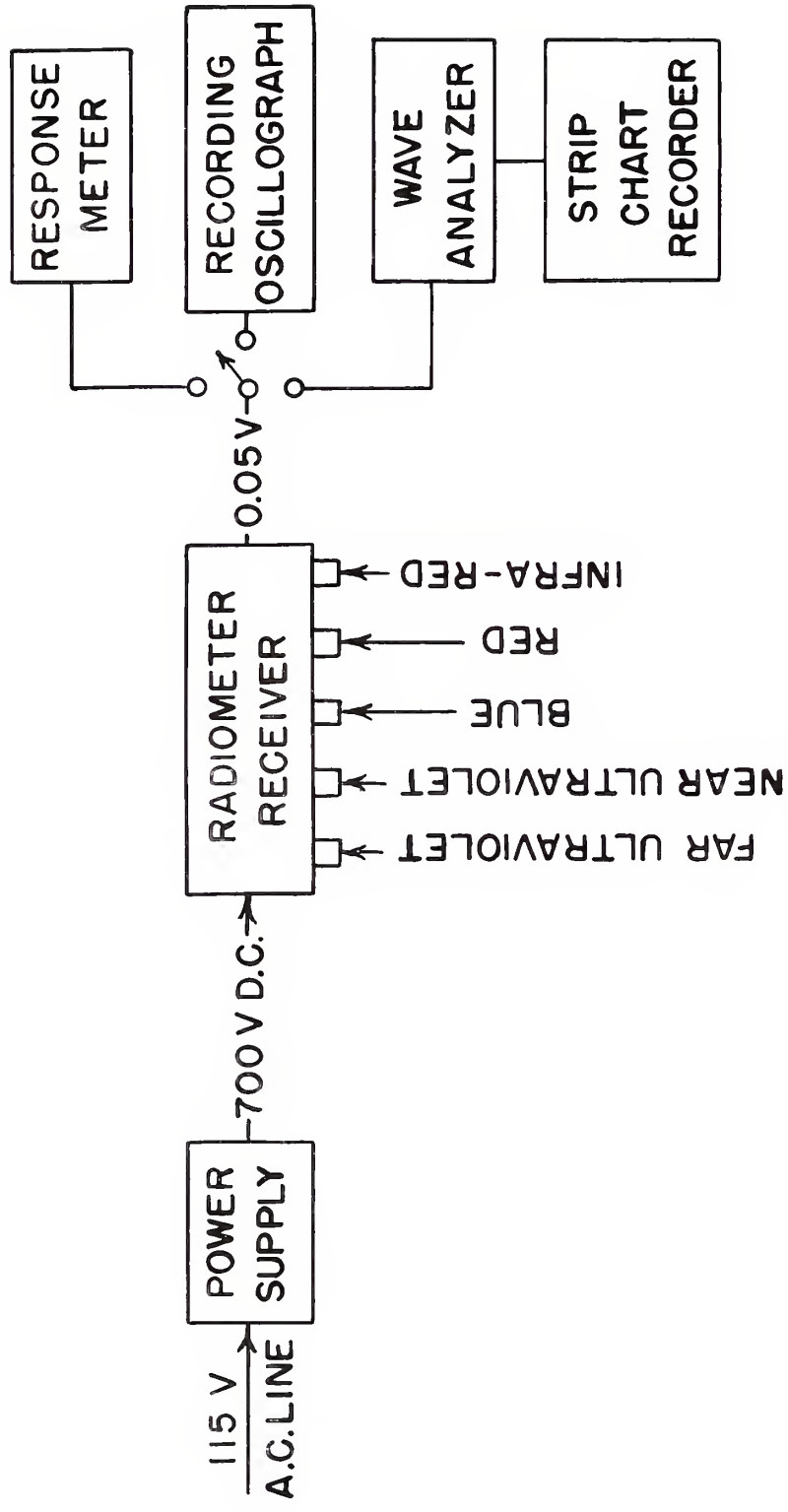

FIG. 5 BLOCK DIAGRAM OF RADIATION ANALYZER



FIG. 6 SPECTRORADIOMETER RECEIVER,
REAR VIEW OF INTERIOR

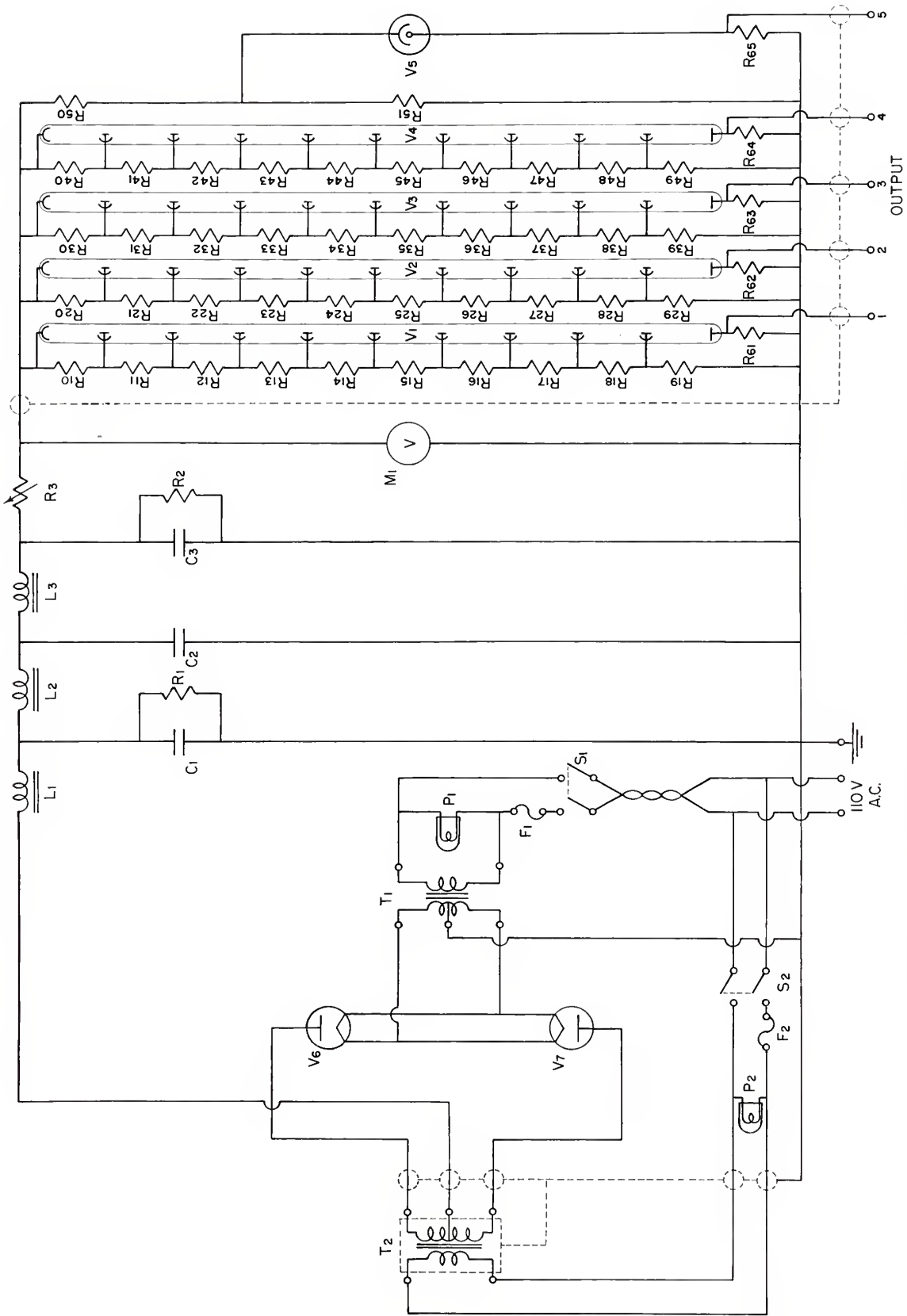

FIG. 7 SCHEMATIC DIAGRAM OF SPECTRORADIOMETER

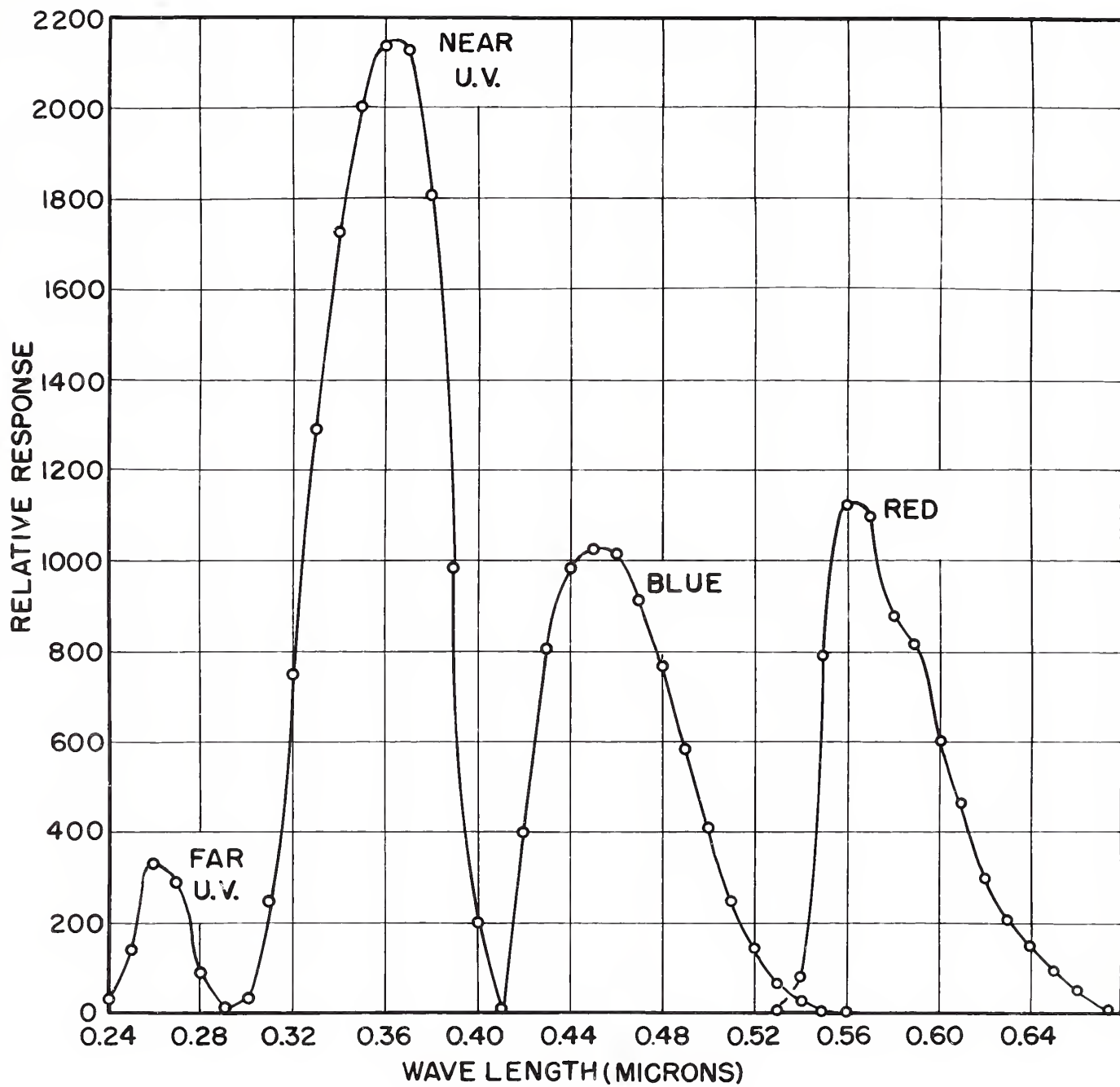

FIG. 8 RELATIVE RESPONSE OF RADIOMETER

24/11/20

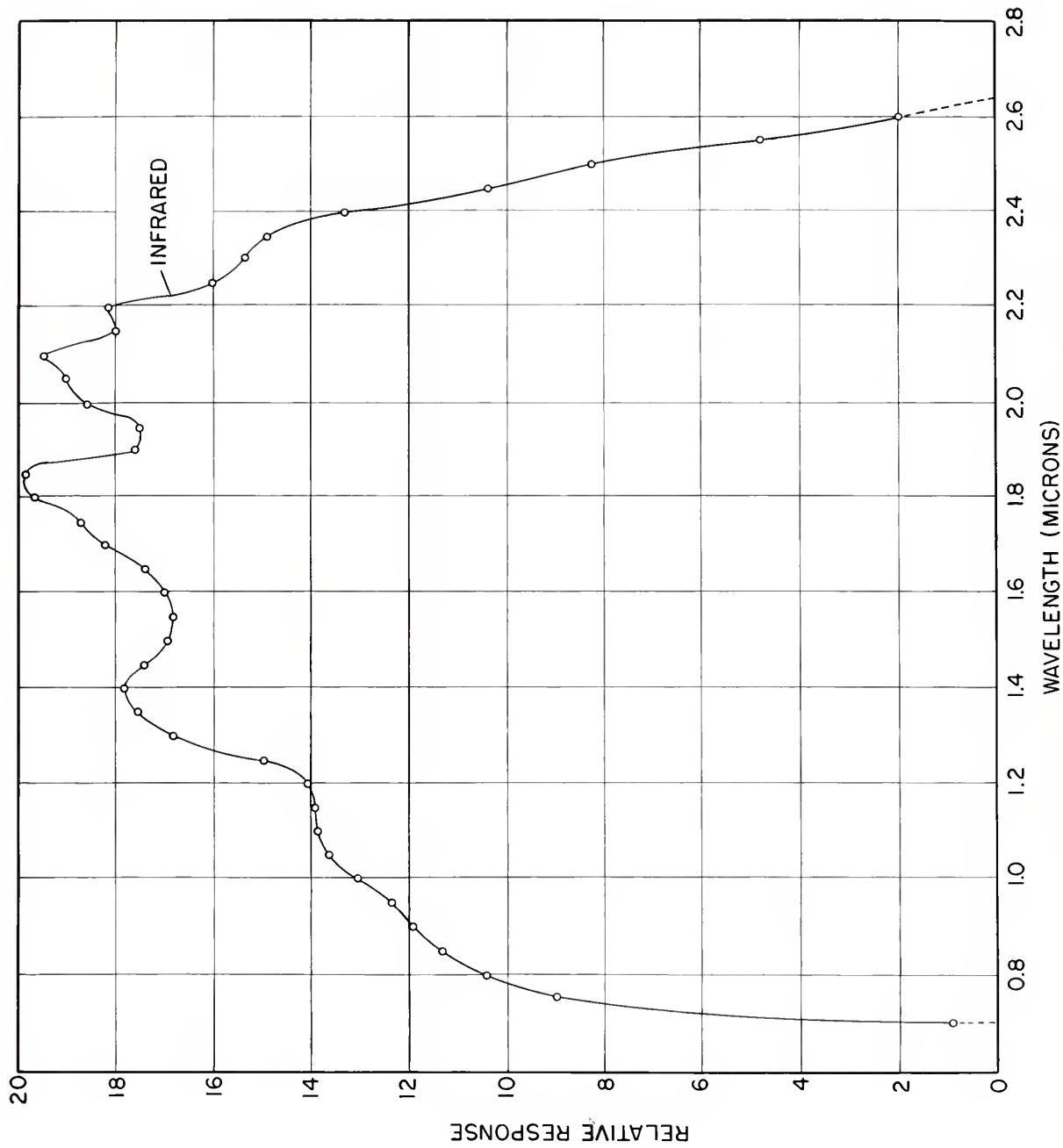

FIG.9 RELATIVE RESPONSE OF RADIOMETER

24101

2

one centimeter in length and was filled with an aqueous solution containing 20 mg of 1, 4-diazepine-2, 3-dihydro-5, 7-dimethyl perchlorate in 100 ml of solution. These three liquid filters were used together with a Corning "Red Purple Corex A" filter with color specification number 7-54.

2. The second spectral region was the near ultraviolet region between 0.30 and 0.41 micron. The filter used was an "Ultraviolet Filter", Catalog number 5204, obtained from the Photovolt Corporation.

3. The third spectral region was the blue end of the visible spectrum between 0.41 and 0.55 micron. A combination of two Corning glass filters was used, a "Light Theatre Blue" filter with color specification number 5-56 and a "Soviol Shade A" filter with color specification number 3-73.

4. The fourth spectral region was the yellow end of the visible spectrum between 0.55 and 0.70 micron. The filter was a Corning glass "H. R. Lantern Shade Yellow" filter with color specification number 3-67.

5. The spectral region of longest wavelength was the infrared region from 0.70 to 2.5 microns. The filter was an "Infra-Red Filter" Catalog No. 5263 from the Photovolt Corporation.

The power supply provided a stabilized potential difference of 700 volts, with an alternating component of less than 0.001%, for operating the receiving elements. The sensitivity of the photomultipliers was about one volt per (microwatt/cm²) but to assure linearity and reproducibility, the receiver was always placed at a sufficient distance from the source to keep the response below 75 millivolts. The infrared cell had a sensitivity of about 400 millivolts per (microwatt/cm²). A circuit diagram of the instrument is shown in Fig. 7, and the circuit components were as follows:

C₁ = 9 microfarads

C₂ = 8 microfarads

C₃ = 16 microfarads

F₁ = 3/4 amp

F₂ = 2 amp

L_{1,2,3} = 30h 35 ma DC 2kv ins.

M₁ = 0 -1500v DC

F_{1,2} = 3w 120v panel lamps

R₁ = 4.9 M

R₂ = 10 M

R₃ = 0-10K

R_{10,11,12,14,15,16,17,18} = 20K

R_{20,21,22,24,25,26,27,28} = 20K

R_{30,31,32,34,35,36,37,38} = 20K

R_{40,41,42,44,45,46,47,48} = 20K

R_{19,29,39,49} = 39K

R_{13,23,33,43} = 11K

R₅₀ = 348K

R₅₁ = 40K, 1%, 1w

R_{61,62,63,64} = 510 ohms

R₆₅ = 400K, 1%, 1w

S_{1,2} = dpst toggle switch

T₁ = 2.5v center tap filament transformer 10 amp

T₂ = plate transformer 700-0-700v 130 ma

V_{1,2,3,4} = 1P28 photomultiplier tubes

V₅ = Kodak Ektron PbS cell, 4x4 mm

V_{6,7} = 666A rectifier tubes

The response potentials could be utilized in several ways, as is shown in Fig. 5. They could be read directly on a millivoltmeter, they could be introduced into a recording oscillograph, or one could be put into a wave analyzer. The millivoltmeter was useful when an immediate indication was required, it was not necessary to follow rapid variations, and it was not desired to measure the output of all five cells simultaneously.

The recording oscillograph, shown at "D" in Fig. 4, gave a permanent photographic film record of the instantaneous values of all five output signals simultaneously. It was essentially a row of eight small oscilloscopes facing a camera in which 35 mm film was continuously exposed as it moved at a constant speed of about two inches per second at right angles to the deflection on the tubes. A continuous trace appeared for each of the signals. The output of a fixed frequency oscillator was recorded on one of the remaining oscilloscopes to provide a time scale. A sample of the record film is shown in Fig. 10.

For calibration purposes, a standardized mercury vapor lamp, General Electric type M100-A4, was used with filters to isolate desired lines in the mercury spectrum. The 0.365 micron line was isolated with a Corning 5860 filter and the 0.378 micron line was isolated with a combination of Corning 4784 and 3460 filters. For each wavelength region, a response was obtained for the standard lamp and one for a flame, with each at a distance which caused the oscillograph deflections to be about the same. The ratio of these deflections, the viewing distances, and the known radiant intensity of the standard lamp were used to calculate the radiant intensity of the flame. In this calculation, the unknown spectral distribution was taken to be uniform within each small region and the spectral response of each cell was taken to be constant and equal to the average response over the wavelength region.

3.1.3 Radiometric Terminology

The rate at which energy is radiated by a blackbody throughout the entire spectrum and through a solid angle of a hemisphere is given by

$$P = \sigma A T^4$$

where A is the area, T is the temperature in degrees absolute, and σ is a constant, the value of which depends upon the units used. If A is in square centimeters and T is in degrees K, $\sigma = 5.68 \times 10^{-12}$ watts/ (cm²-°K⁴) for P to be expressed in watts.

The following is a list of the names of the persons who have been appointed to the various positions in the office of the Secretary of the State of New York, for the term ending on the 31st day of December, 1901.

The following is a list of the names of the persons who have been appointed to the various positions in the office of the Secretary of the State of New York, for the term ending on the 31st day of December, 1901.

The following is a list of the names of the persons who have been appointed to the various positions in the office of the Secretary of the State of New York, for the term ending on the 31st day of December, 1901.

1-1-1

The following is a list of the names of the persons who have been appointed to the various positions in the office of the Secretary of the State of New York, for the term ending on the 31st day of December, 1901.

1 2 3

The following is a list of the names of the persons who have been appointed to the various positions in the office of the Secretary of the State of New York, for the term ending on the 31st day of December, 1901.

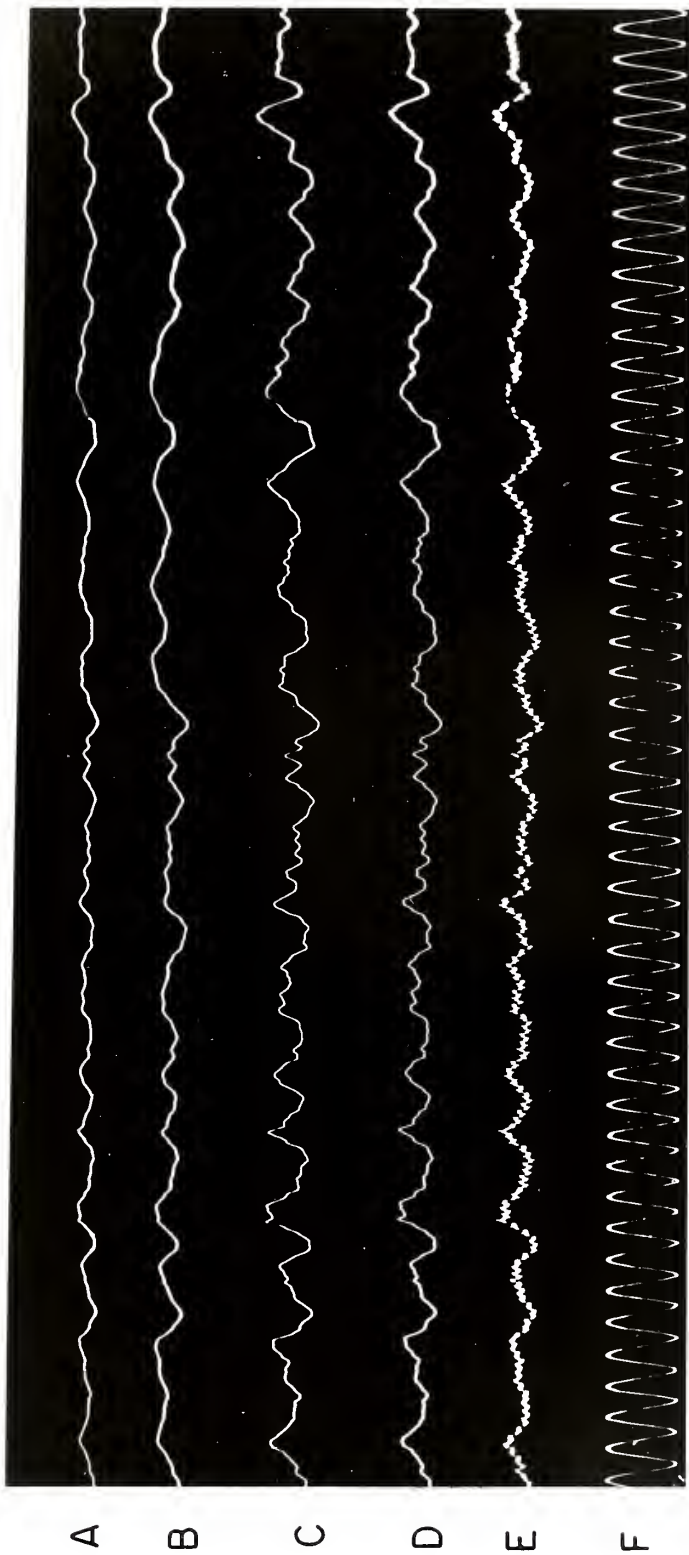

FIG. 10 OSCILLOGRAPH RECORD OF VARIATIONS IN RADIANT INTENSITY IN FIVE WAVELENGTH REGIONS.X4

- (A) 0.70 TO 2.5 MICRONS
- (B) 0.55 TO 0.77
- (C) 0.41 TO 0.55
- (D) 0.30 TO 0.41
- (E) 0.235 TO 0.290
- (F) 40 cps TIMING TRACE

201

The quantity $W = P/A$ is known as the radiant flux density at the surface and is expressed in watts/cm². For a blackbody, $W = \sigma T^4$. The rate at which radiant energy falls upon a unit area of a surface is known as the irradiance and is also expressed in watts/cm².

The rate at which energy is radiated by a body throughout the spectrum and through a solid angle of one steradian is known as the radiant intensity, J , and is expressed in watts/steradian. For a blackbody,

$$J = \frac{P}{\pi} = \frac{A \sigma T^4}{\pi}$$

The rate at which energy is radiated by a body throughout the spectrum, through a solid angle of one steradian, and per unit of projected area is known as the radiance, N , and is expressed in watts/(cm²-steradian). The radiance and radiant intensity of radiating surfaces, in general, depend upon the direction of radiation, which must, therefore, be specified. It is often convenient and useful to deal with the radiance in the direction normal to the surface, the normal radiance. The following relationships apply to a blackbody and are derived from the fact that the radiance in this case is uniform over the entire projected area and is independent of direction.

$$N = \frac{J}{A} = \frac{P}{A \pi} = \frac{W}{\pi} = \frac{\sigma T^4}{\pi}$$

It is convenient to use the term radiant intensity, J , in expressing the radiant emission in a particular direction when the source is small and the spacial distribution of the source is non-uniform. However, if the dimensions of the source are large compared to the distance from the receiver to the source, it is more appropriate to use the term radiance, N .

The radiance of a body for a small wavelength interval about a given wavelength is known as the spectral radiance, N_λ at that wavelength and is expressed in watts/(cm²-steradian-micron). The spectral radiance of a blackbody is

$$N_\lambda = \frac{C_1}{\lambda^5 \left(e^{\frac{C_2}{\lambda T}} - 1 \right)}$$

where C_1 and C_2 are constants and λ is the wavelength. For N_λ to be expressed in watts/(cm²-steradian-micron), λ is in microns, $C_2 = 14380$ micron-degrees K, and C_1 has the numerical value of 1.1906×10^4 .

The first part of the paper is devoted to the study of the asymptotic behavior of the function $f(x)$ as $x \rightarrow \infty$. It is shown that $f(x) \sim \frac{1}{x}$ as $x \rightarrow \infty$. The second part of the paper is devoted to the study of the asymptotic behavior of the function $f(x)$ as $x \rightarrow 0$. It is shown that $f(x) \sim \frac{1}{x}$ as $x \rightarrow 0$.

$$\frac{0}{\pi} = \frac{1}{\pi}$$

The third part of the paper is devoted to the study of the asymptotic behavior of the function $f(x)$ as $x \rightarrow \infty$. It is shown that $f(x) \sim \frac{1}{x}$ as $x \rightarrow \infty$. The fourth part of the paper is devoted to the study of the asymptotic behavior of the function $f(x)$ as $x \rightarrow 0$. It is shown that $f(x) \sim \frac{1}{x}$ as $x \rightarrow 0$.

$$\frac{0}{\pi} = \frac{1}{\pi} + \frac{1}{\pi}$$

The fifth part of the paper is devoted to the study of the asymptotic behavior of the function $f(x)$ as $x \rightarrow \infty$. It is shown that $f(x) \sim \frac{1}{x}$ as $x \rightarrow \infty$. The sixth part of the paper is devoted to the study of the asymptotic behavior of the function $f(x)$ as $x \rightarrow 0$. It is shown that $f(x) \sim \frac{1}{x}$ as $x \rightarrow 0$.

The seventh part of the paper is devoted to the study of the asymptotic behavior of the function $f(x)$ as $x \rightarrow \infty$. It is shown that $f(x) \sim \frac{1}{x}$ as $x \rightarrow \infty$. The eighth part of the paper is devoted to the study of the asymptotic behavior of the function $f(x)$ as $x \rightarrow 0$. It is shown that $f(x) \sim \frac{1}{x}$ as $x \rightarrow 0$.

$$1 - \frac{1}{\pi} = \frac{1}{\pi}$$

The ninth part of the paper is devoted to the study of the asymptotic behavior of the function $f(x)$ as $x \rightarrow \infty$. It is shown that $f(x) \sim \frac{1}{x}$ as $x \rightarrow \infty$. The tenth part of the paper is devoted to the study of the asymptotic behavior of the function $f(x)$ as $x \rightarrow 0$. It is shown that $f(x) \sim \frac{1}{x}$ as $x \rightarrow 0$.

The symbol $N(\lambda_1 - \lambda_2)$ is used here to denote the normal radiance of the radiating source for all wavelengths between λ_1 and λ_2 . The normal radiance from the flames and from blackbodies in the wavelength regions transmitted by pyrex, quartz, and calcium fluoride will be referred to as $N(0-2.6)$, $N(0-3.8)$, and $N(0-9.5)$, respectively. However, the actual values of the effective wavelength cutoffs were used in determining the normal radiance for blackbodies.

3.1.4 Results

3.1.4.1 Normal Radiance

The results obtained for the normal radiance from the jet burner flames in which the fuel and air were premixed and the mixture preheated are given in Tables 1 and 2. The observations were made on the vertical surfaces of the flames and, since the burners and flames were different in width and the conditions of operation different, no direct correlation between the results obtained with the two burners would be expected. In each case, the normal radiance in each wavelength band increased as the fuel-air ratio was increased.

The results obtained for the jet burner flames in which the liquid fuel was injected into a preheated air stream are given in Table 3. These flames, as well as the richer of the other premixed flames, were more yellow at the tips than at the burner outlet. Surveys of the normal radiance were made along these flames, from the burner outlet to the points where the flames began to break up. Although the values of $N(0-9.5)$ increased less than 20 percent, the values of $N(0-2.6)$ approximately doubled as the more yellow parts of the flame were approached.

The following values of normal radiance were obtained with a flame produced by burning a stoichiometric mixture of natural gas and air with a 1 13/16 in. diameter burner:

$N(0-2.6)$	0.07 watt/(cm ² -steradian)
$N(0-3.8)$.20 watt/(cm ² -steradian)
$N(0-9.5)$.60 watt/(cm ² -steradian)

These values are not very different from those given in Table 1 for a stoichiometric mixture of gasoline and air. These flames were of approximately the same thickness at the location where the measurements were made.

1. The first part of the report is a general introduction to the subject of the study. It discusses the importance of the study and the objectives of the research. It also provides a brief overview of the methodology used in the study.

2. The second part of the report is a detailed description of the methodology used in the study. It discusses the data collection methods, the sample size, and the statistical tests used to analyze the data.

3. The third part of the report is a discussion of the results of the study. It discusses the findings of the study and compares them to the results of previous studies. It also discusses the implications of the findings for practice and policy.

4. The fourth part of the report is a conclusion and recommendations. It summarizes the main findings of the study and provides recommendations for future research. It also discusses the limitations of the study and the strengths of the findings.

5. The fifth part of the report is a list of references. It lists the sources of information used in the study, including books, articles, and other documents. The references are listed in alphabetical order of the author's name.

6. The sixth part of the report is an appendix. It contains additional information that is not included in the main body of the report, such as raw data, detailed calculations, and other supporting materials.

Appendix A: Raw data

Appendix B: Detailed calculations

7. The seventh part of the report is a list of figures and tables. It provides a brief description of each figure and table and indicates where they can be found in the report. The figures and tables are presented in a clear and concise manner, making them easy to understand and interpret.

Table 1. Spectral Radiance of Primed Glass using Jet Turbine No. 1

(Fuel, CO ocean baseline. Primature Temperature, 409° F)

Wavelength	Prim. Temperature	10/min	Spectral Radiance	$\frac{\text{Spectral Radiance}}{\text{Temperature}^4}$
0.6479	1.30	1.30	0.06	0.29
0.6614	1.40	1.40	.12	.47
0.6730	1.90	1.90	.18	.68
0.6845	1.20	1.20	.24	.82
0.6960	1.50	1.50	.34	.93
0.6963	1.50	1.50	.40	1.07

This observation was taken 28 in. downstream. All others at 6 in. downstream.

THE UNIVERSITY OF CHICAGO

PHYSICS DEPARTMENT
5712 S. UNIVERSITY AVE.
CHICAGO, ILL. 60637

PHYSICS 309

LECTURE 1

PHYSICS 309

PHYSICS 309

PHYSICS 309

Table 2. Normal Radiance of Premixed Flames Using Jet Burner No. 2
(Fuel, 80 Octane Gasoline)

Fuel-Air Ratio	Fuel Consumption lb/min	Premixed Fuel-Air Temp. °F	Premixed Fuel-Air Velocity ft/sec	Exhaust Gas Temp. °F	Observed N(0-3.8)	Normal Radiance Watts/(cm ² -steradian)	By Difference N(2.6-3.8)	N(3.8-9.5)
0.0458	1.40	300	140	2350	0.11	0.43	0.08	0.32
.0466	2.36	300	228	2200	.08	.30	.06	.22
.0492	3.28	300	294	2430	.10	.38	.07	.28
.0475	4.46	300	393	2090	.07	.28	.05	.21
.0700	2.05	310	136	3200	.35	1.05	.25	.70
.0694	3.45	310	226	3260	.30	.97	.21	.67
.0709	4.70	300	291	3300	.29	.93	.20	.64
.0700	6.60	291	387	3300	.24	.82	.17	.58
0.1092	3.27	300	140	2710	.47	1.27	.32	.80
.1010	5.00	300	223	2890	.29	.88	.17	.59
.0912	6.00	300	286	3060	.31	.93	.21	.62

This is the temperature indicated by the bare junction of an iridium/iridium-rhodium thermocouple located at the burner outlet. The thermocouple wires were 0.035 inch in diameter.

1. The number of...
 2. The number of...
 3. The number of...

Year	1970	1971	1972	1973	1974	1975	1976	1977	1978	1979	1980	1981	1982	1983	1984	1985	1986	1987	1988	1989	1990	1991	1992	1993	1994	1995	1996	1997	1998	1999	2000	2001	2002	2003	2004	2005	2006	2007	2008	2009	2010	2011	2012	2013	2014	2015	2016	2017	2018	2019	2020	2021	2022																																																																																																																																
Population	100	105	110	115	120	125	130	135	140	145	150	155	160	165	170	175	180	185	190	195	200	205	210	215	220	225	230	235	240	245	250	255	260	265	270	275	280	285	290	295	300	305	310	315	320	325	330	335	340	345	350	355	360	365	370	375	380	385	390	395	400	405	410	415	420	425	430	435	440	445	450	455	460	465	470	475	480	485	490	495	500	505	510	515	520	525	530	535	540	545	550	555	560	565	570	575	580	585	590	595	600	605	610	615	620	625	630	635	640	645	650	655	660	665	670	675	680	685	690	695	700	705	710	715	720	725	730	735	740	745	750	755	760	765	770	775	780	785	790	795	800	805	810	815	820	825	830	835	840	845	850	855	860	865	870	875	880	885	890	895	900	905	910	915	920	925	930	935	940	945	950	955	960	965	970	975	980	985	990	995	1000

1. The number of...
 2. The number of...
 3. The number of...

Table 3. Normal Radiance of Liquid Injection Flames Using Jet Burner No. 2 (Fuel, 80 Octane Gasoline)

Fuel-Air Ratio	Fuel Consumption lb/min	Premixed Air Temp. °F	Velocity ft/sec	Exhaust Gas Temp °F	Observed \bar{N} (0-3.8)	Normal Radiance Watts/(cm ² -steradian) By Difference \bar{N} (2.6-3.8)	\bar{N} (0-9.5)	\bar{N} (3.8-9.5)
0.0460 ^a	2.32	113	171	2150	0.12	0.09	0.45	0.33
.0460	2.32	113	171	2150	.17	.11	.53	.36
.0471	3.14	115	221	2600	.20	.13	.66	.46
.0470	4.43	121	301	2850	.17	.12	.59	.42

^aThis observation was taken 6 in. downstream from burner outlet. All others taken at 18 in. downstream.

This is the temperature indicated by the bare junction of an iridium/iridium-rhodium thermocouple located at the burner outlet. The thermocouple wires were 0.035 inch in diameter.

The results obtained for the normal radiance of various diffusion flames are given in Table 4. The values observed for the large fire were much higher than those for any of the other flames. This is attributed to its greater thickness. The percentage of the energy in the shorter wavelength regions of the diffusion flames was appreciably greater than that for the premixed flames.

The ranges of values obtained for the normal radiance in the different wavelength regions of all the flames studied are given in Table 5.

Table 5. Range of Values of Normal Radiance for all Flames Studied

Wavelength Span Microns	Normal Radiance Watts/(cm ² -Steradian)	Ratio <u>max value</u> min value
0-2.6	0.02-1.80	90
2.6-3.8	0.05-0.98	20
3.8-9.5	0.21-1.09	5
0-3.8	0.06-2.78	46
0-9.5	0.27-3.87	14

The ratios of the energy radiated in the wavelength regions, 0 to 2.6, 0 to 3.8, 2.6 to 3.8, and 3.8 to 9.5 microns to that in the region 0 to 9.5 microns are shown in Figs 11, 12, 13, and 14, respectively. The values for the ratio $N(0-2.6)$ to $N(0-9.5)$ for the diffusion flames ranged from 0.32 to 0.48 compared to 0.07 to 0.14 for the premixed flames. The values of the ratio $N(0-3.8)$ to $N(0-9.5)$ for the diffusion flames ranged from 0.47 to 0.75 compared to 0.22 to 0.38 for the premixed flames. As shown in Fig. 13, the values of the ratio $N(2.6-3.8)$ to $N(0-9.5)$ was not very different for the various types of flames. Since the fraction of the energy radiated in the shorter wavelength regions increased as $N(0-9.5)$ increased, that in the longer wavelength region, 3.8 to 9.5 microns, decreased, as shown in Fig. 14.

The values of the radiance in the different wavelength regions of a blackbody at various temperatures are given in Table 6 for comparison with those observed for flames. In the wavelength region 0 to 2.6 microns, the values for the premixed flames, 0.02 to 0.15 watt/(cm²-steradian), corresponded to those of a blackbody at temperatures of 800° to 1140°F, and those for the diffusion flames, 0.34 to 1.80 watts/(cm²-steradian), corresponded to those of a blackbody at temperatures of 1330° to 1850°F. In the wavelength region 0 to 3.8 microns, the values for the premixed flames, 0.06 to 0.47 watt/(cm²-steradian), corresponded to those of a blackbody at temperatures of 730° to 1130°F, and those for the diffusion flames,

The results obtained for the various values of α are given in Table 4. The values obtained for the various values of α are given in Table 4. The values obtained for the various values of α are given in Table 4.

The results obtained for the various values of α are given in Table 4. The values obtained for the various values of α are given in Table 4. The values obtained for the various values of α are given in Table 4.

Table 4. Values of α for various values of α .

Value of α	Value of α	Value of α
0.1	0.1	0.1
0.2	0.2	0.2
0.3	0.3	0.3
0.4	0.4	0.4
0.5	0.5	0.5

The values of α for various values of α are given in Table 4. The values obtained for the various values of α are given in Table 4. The values obtained for the various values of α are given in Table 4.

The values of α for various values of α are given in Table 4. The values obtained for the various values of α are given in Table 4. The values obtained for the various values of α are given in Table 4.

Table 4. Normal Radiance of Diffusion Flames Under Various Conditions

Fuel and Burner	Fuel Consumption lb/min	Wind Speed	Normal Radiance Watts/(cm ² -steradian)				
			Observed M(0-2.6) M(0-3.8) M(0-9.5)	By Difference M(2.6-3.8) M(3.8-9.5)			
Gasoline in 6 in. dia- meter container	0.053	Negligible	0.36	0.48	0.77	0.12	0.29
	.13	10 mph	.49	.75	1.51	.26	.76
	.16	20 mph	.34	.60	1.08	.26	.48
Hydraulic fluid in 6 in. dia- meter container	0.017	Negligible	.47	.76	1.09	.29	.33
	.063	10 mph	.58	.81	1.72	.23	.91
	.072	20 mph	.50	.74	1.16	.24	.44
Lubricating oil in 6 in. diameter container	.025	Negligible	.49	.80	1.33	.31	.53
	.030	10 mph	.95	1.47	1.97	.52	.50
Gasoline in 4x4 ft container	5 to 6	Negligible	1.80	2.78	3.87	.98	1.09

Category	Item	QTY	UNIT PRICE	TOTAL	DATE	REMARKS
MATERIALS	1. 2x4	100	1.00	100.00	10/10/50	
	2. 2x6	50	1.50	75.00	10/10/50	
	3. 2x8	25	2.00	50.00	10/10/50	
LABOR	4. 10 hrs	100	1.00	100.00	10/10/50	
	5. 20 hrs	50	2.00	100.00	10/10/50	
	6. 30 hrs	25	3.00	75.00	10/10/50	
EQUIPMENT	7. 100 ft	100	1.00	100.00	10/10/50	
	8. 200 ft	50	2.00	100.00	10/10/50	
	9. 300 ft	25	3.00	75.00	10/10/50	

TOTAL PROJECT COST \$1,000.00

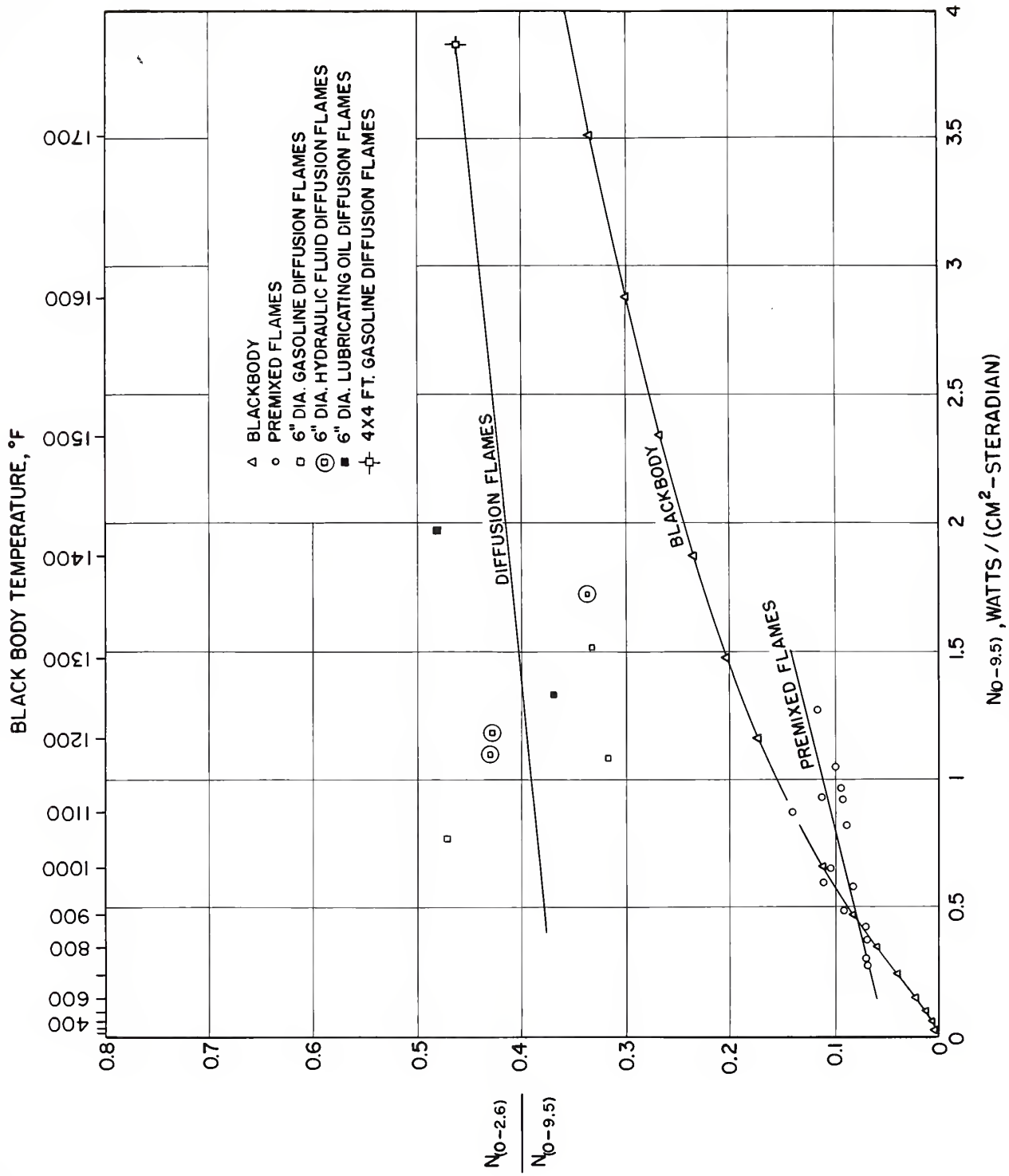

FIG.11 RATIO OF ENERGY THROUGH PYREX AND FLUORIDE WINDOWS

24101

3

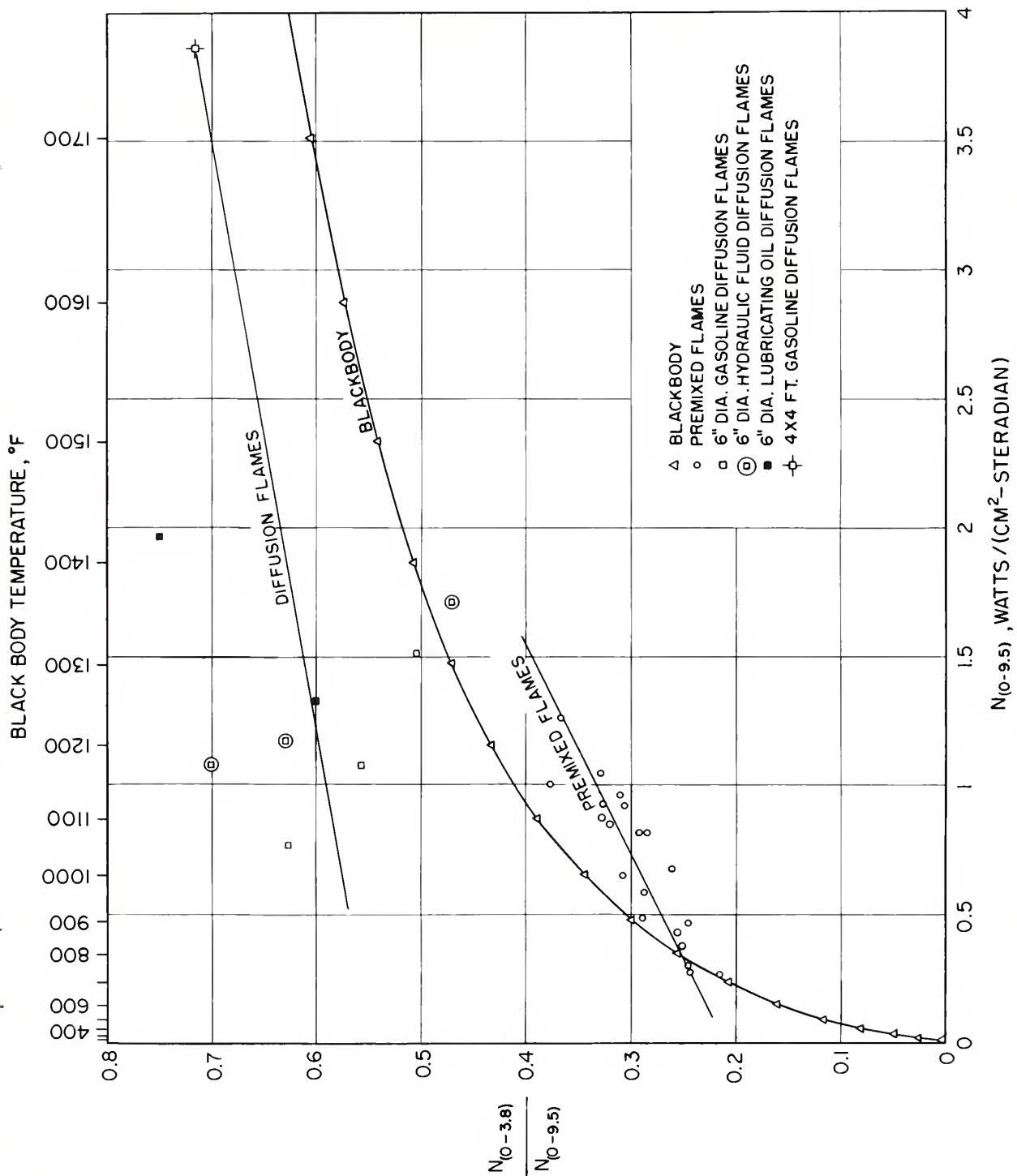

FIG. 12 RATIO OF ENERGY THROUGH QUARTZ AND FLUORIDE WINDOWS

2011年12月

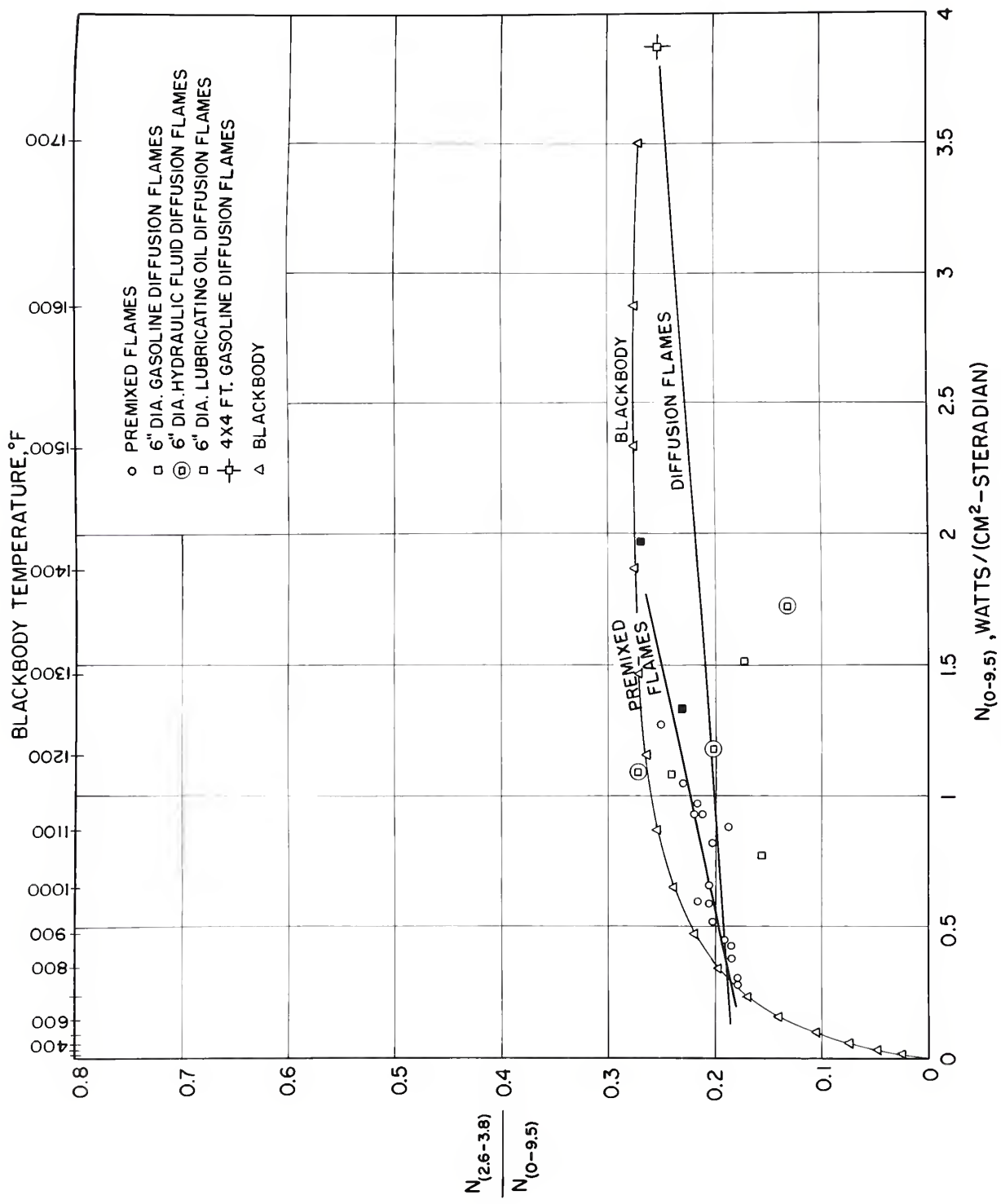

FIG.13 RATIO $N_{(2.6-3.8)}$ TO $N_{(0-9.5)}$

2450
2

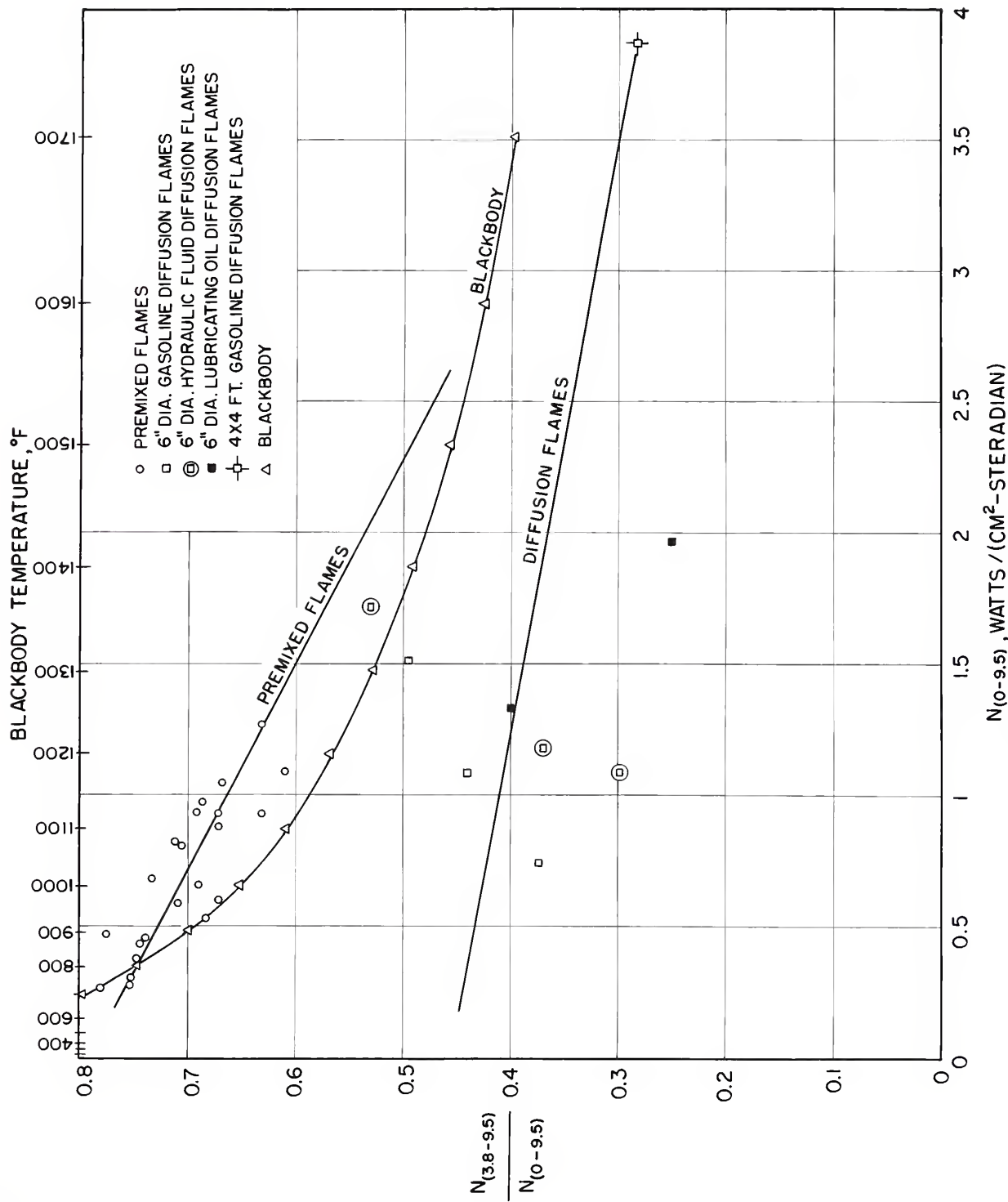

FIG. 14 RATIO $N_{(3.8-9.5)}$ TO $N_{(0-9.5)}$

24161

6

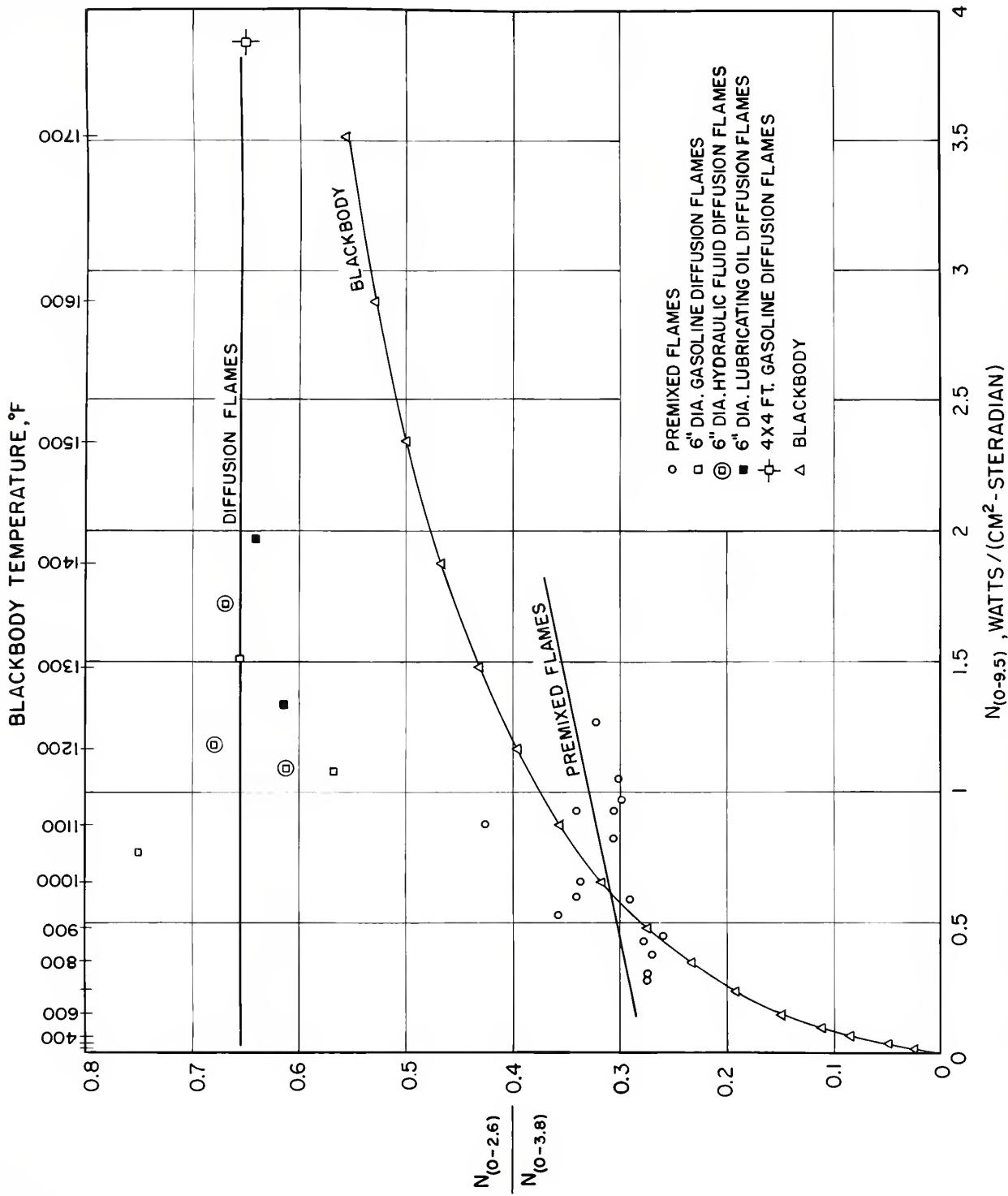

FIG. 15 RATIO OF RADIANT ENERGY THROUGH PYREX AND QUARTZ WINDOWS

24191

Table 6. Radiance of a Blackbody at Various Temperatures

Temperature		Radiance Watts/(cm ² -Steradian)					
°F	°K	N(0-2.6)	N(0-3.8)	N(0-9.5)	N(0-∞)	N(2.6-3.8)	N(3.8-9.5)
200	366.3	0.000007	0.00031	0.0128	0.0326	0.0003	0.0125
300	421.9	.000064	.00136	.0282	.0572	.0013	.0268
400	477.4	.00036	.00435	.0543	.0940	.0040	.0499
500	533.0	.00124	.0112	.0945	.146	.0100	.0833
600	588.6	.00368	.0247	.153	.217	.0210	.128
700	644.1	.00921	.0485	.234	.311	.0393	.185
800	699.7	.0201	.0868	.342	.433	.0667	.255
900	755.2	.0397	.145	.482	.588	.105	.337
1000	810.8	.0721	.229	.660	.781	.157	.431
1100	866.3	.122	.344	.882	1.019	.222	.538
1200	921.9	.196	.498	1.154	1.306	.302	.656
1300	977.4	.301	.699	1.483	1.650	.398	.784
1400	1033.0	.443	.953	1.875	2.059	.510	.922
1500	1088.6	.631	1.269	2.339	2.539	.638	1.070
1600	1144.1	.873	1.656	2.881	3.098	.783	1.225
1700	1199.7	1.179	2.122	3.512	3.745	.943	1.390
1800	1255.2	1.558	2.675	4.239	4.488	1.117	1.564

0.43 to 2.76 watts/(cm²-steradian) corresponded to those of a blackbody at temperatures of 1190° to 1820°F. In the wavelength region 0 to 9.5 microns, the values for the premixed flames, 0.27 to 1.27 watts/(cm²-steradian), corresponded to those of a blackbody at temperatures of 660° to 1190°F, and those for the diffusion flames, 0.77 to 3.87 watts/cm²-steradian, corresponded to a blackbody at temperatures of 990° to 1720°F.

The ratios of $\bar{N}(0-2.6)$ to $\bar{N}(0-9.5)$ and $\bar{N}(0-3.8)$ to $\bar{N}(0-9.5)$ for a blackbody at different temperatures are also shown in Figs. 11 and 12, respectively. These ratios, compared to those observed for the flames, are summarized in Table 7. Although the greater part of the energy radiated by the premixed flames was at wavelengths longer than 3.8 microns, the same is true of a blackbody at temperatures below 1300°F. In general, the greater part of energy radiated by the diffusion flames was at wavelengths shorter than 3.8 microns. Even though a pyrex window transmits only about 40 percent of the radiant energy from a diffusion flame, it transmits a much smaller percentage of the radiant energy from a blackbody at temperatures below 1300°F. Consequently, if aircraft accidental fires are expected to be of the diffusion type, a pyrex window would appear to be more suitable than one transmitting at longer wavelengths because it would absorb a relatively higher percentage of the background radiation. The spectral radiance curves for a blackbody at different temperatures are shown together with the spectral transmittance curves of pyrex (P), quartz (Q), and calcium fluoride (F) in Fig. 16.

The ratios of the normal radiance in various parts of the spectrum provide a means of computing the temperature of the solid radiating particles in the diffusion flames. Since the emissivity of solid carbon is essentially independent of wavelength, the diffusion flames will radiate essentially as a greybody which, for a given temperature, will have the same distribution of energy throughout the spectrum as a blackbody. The most appropriate ratio to use for this purpose is $\bar{N}(0-2.6)$ to $\bar{N}(0-3.8)$ because the CO₂ band at around 4.4 microns is excluded. The average value of the ratio $\bar{N}(0-2.6)$ to $\bar{N}(0-3.8)$ obtained for all the diffusion flames was 0.655. The ratio of $\bar{N}(0-2.6)$ to $\bar{N}(0-3.8)$ for a greybody at 2200°F is 0.657. Since this ratio was approximately the same for all the diffusion flames, see Fig. 15, it would appear that they were all at approximately the same temperature and that the differences in the values of the normal radiance were due primarily to differences in the thickness and emissivity.

The value for the ratio of $\bar{N}(0-2.6)$ to $\bar{N}(0-9.5)$ was 0.466 for the large gasoline fire and is 0.473 for a greybody at 2200°F. The value for the ratio of $\bar{N}(0-3.8)$ to $\bar{N}(0-9.5)$ was

The first of these is the fact that the
... of the ... of the ... of the ...
... of the ... of the ... of the ...
... of the ... of the ... of the ...

The second of these is the fact that the
... of the ... of the ... of the ...
... of the ... of the ... of the ...
... of the ... of the ... of the ...
... of the ... of the ... of the ...
... of the ... of the ... of the ...
... of the ... of the ... of the ...
... of the ... of the ... of the ...
... of the ... of the ... of the ...
... of the ... of the ... of the ...
... of the ... of the ... of the ...
... of the ... of the ... of the ...
... of the ... of the ... of the ...
... of the ... of the ... of the ...
... of the ... of the ... of the ...
... of the ... of the ... of the ...

The third of these is the fact that the
... of the ... of the ... of the ...
... of the ... of the ... of the ...
... of the ... of the ... of the ...
... of the ... of the ... of the ...
... of the ... of the ... of the ...
... of the ... of the ... of the ...
... of the ... of the ... of the ...
... of the ... of the ... of the ...
... of the ... of the ... of the ...
... of the ... of the ... of the ...
... of the ... of the ... of the ...
... of the ... of the ... of the ...
... of the ... of the ... of the ...
... of the ... of the ... of the ...
... of the ... of the ... of the ...
... of the ... of the ... of the ...

The fourth of these is the fact that the
... of the ... of the ... of the ...
... of the ... of the ... of the ...

Table 7. Ratio of Radiant Flux in Different Wavelength Regions of Various Sources

Source	$\frac{H(0-2.6)}{H(0-9.5)}$	$\frac{H(0-3.3)}{H(0-9.5)}$
Premixed Flames	0.07-0.14	0.22-0.39
Diffusion Flames	0.32-0.48	0.47-0.75
Blackbody at 400°F	0.0066	0.060
Blackbody at 600°F	0.024	0.16
Blackbody at 800°F	0.059	0.25
Blackbody at 1000°F	0.11	0.35
Blackbody at 1200°F	0.17	0.43
Blackbody at 1300°F	0.20	0.47

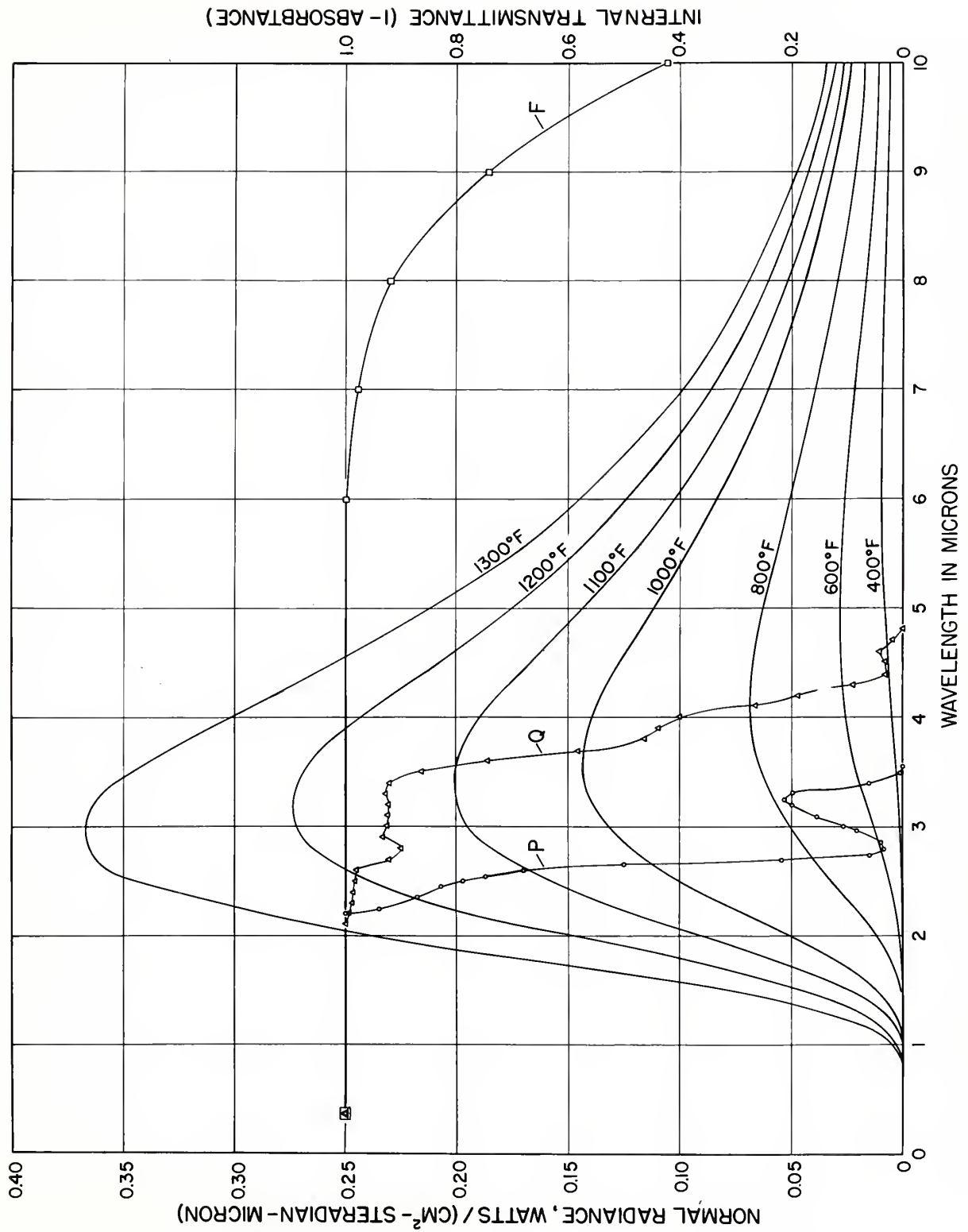

FIG.16 SPECTRAL RADIANCE CURVES FOR BLACK BODIES AND INTERNAL TRANSMITTANCE CURVES OF WINDOW MATERIALS

24101

8

0.717 for the large gasoline fire and is 0.720 for a greybody at 2200°F. These values would indicate that the radiant energy from the CO₂ band at around 4.4 microns contributed very little to the total energy radiated. However, the slightly lower values obtained for these latter ratios with the smaller and less sooty flames indicate that there was some appreciable amount of radiant energy in the 4.4 micron band.

The above measurements indicate that the relative spectral distribution curve for the radiant energy from the diffusion flames obtained in this work was not very different from that of a blackbody at 2200°F, shown in Fig. 1. If there were any peaks in the regions at around 2.8 and 4.4 microns (dotted in the curve), they were not very pronounced. The value of 2200°F obtained for the temperature of diffusion flames in this work was for flames burning in the open. The temperature of similar flames burning in a heated enclosure, such as a nacelle, would be higher.

If the temperature of the radiating particles in the diffusion flames is taken as 2200°F, the effective normal emissivity of the flame, defined as the ratio of the normal radiance of the flame to that of a blackbody at the same temperature, can be computed. The computed values ranged from 0.093 for the small gasoline fire in still air to 0.47 for the large gasoline fire.

3.1.4.2 Radiant Intensity

The values obtained, in the 5 wavelength regions between 0.235 and 2.5 microns, for the radiant intensity of the premixed flames are given in Table 8 and those of the diffusion flames in Table 9. Since the areas of the flames were different, there is no direct correlation among the values obtained for the different flames, except in a general way. The projected areas of the jet burner flames, as viewed by the receiver, were estimated to range from about 1000 to about 2500 sq cm, while those of the diffusion flames ranged from about 200 to about 600 sq cm.

The radiant intensity in the wavelength region 0.235 to 0.290 micron was greater for the liquid injection flames than for any of the other types of flames. The average value was about 0.2 watt/steradian. In all the other premixed flames, except one, it was of sufficient magnitude to be measured with the apparatus used. In the diffusion flames, it was less than 10⁻⁴ watt/steradian, the minimum intensity that could be detected with the apparatus used.

The first part of the report deals with the general situation of the country and the progress of the work done during the year. It is followed by a detailed account of the various projects and the results achieved. The report concludes with a summary of the work done and the prospects for the future.

The second part of the report deals with the financial statement of the organization. It shows the income and expenditure for the year and the balance sheet at the end of the year. It also shows the details of the various projects and the amounts spent on each. The financial statement is followed by a statement of the assets and liabilities of the organization.

The third part of the report deals with the administrative and general matters. It includes a list of the members of the organization and a list of the various committees and their work. It also includes a list of the various projects and the names of the people who have worked on them. The report concludes with a list of the various publications and reports issued during the year.

Financial Statement

The financial statement of the organization for the year 1955 is as follows: Income: Rs. 10,000. Expenditure: Rs. 8,000. Balance at the end of the year: Rs. 2,000. The details of the income and expenditure are given in the following table:

Particulars	Amount (Rs.)
Income	10,000
Expenditure	8,000
Balance at the end of the year	2,000

The following table shows the details of the various projects and the amounts spent on each:

Project	Amount (Rs.)
Project A	1,000
Project B	2,000
Project C	3,000
Project D	2,000

Table 3 Radiant Intensity of Preheated Flames in Wavelength Regions Below 2.5 microns

Fuel-air ratio	Fuel Consumption lb/min	Preheated Fuel-air Temp °F	Exhaust Gas Temp. °F	Radiant Intensity watts/steradian	Yellow to Blue Ratio*
0.0473	1.41	300	2520	4.6x10 ⁻²	<0.02
0.0479	4.53	300	2290	0.14	<0.01
0.0688	2.05	300	3300	3.1	0.50
0.0702	6.60	300	3390	1.0	0.53
0.1062	3.27	300	2810	0.78	0.52
0.0984	6.60	300	3150	1.2	0.55

Gasoline and Air Preheated and Preheated, Jet Burner No. 2

Natural Gas in 1 13/16" Burner

0.069	0.066	25	----	1.0x10 ⁻³	3.9x10 ⁻³	2.9x10 ⁻³	7.4	<0.035
-------	-------	----	------	----------------------	----------------------	----------------------	-----	--------

Gasoline Injected into Preheated Air, Jet Burner No. 2

Preheated Air Temp °F	Preheated Air Temp	Velocity city ft/sec	Radiant Intensity	Yellow to Blue Ratio
113	171	171	0.42	2.3
121	221	221	0.52	2.5
121	301	301	0.70	1.7

* The ratio of radiant intensity in the yellow end of the spectrum (0.55 to 0.70 micron) to that in the blue end (0.41 to 0.55 micron).

1. This is the temperature indicated by the bare junction of an Iridium/Iridium-rhodium thermocouple located at the burner outlet. The thermocouple wires were 0.035 inch in diameter.

we would like to see the following: Attached to this
 document are the following equations:

$$\frac{d^2x}{dt^2} + \frac{dx}{dt} + x = 0$$

$$\frac{d^2y}{dt^2} + \frac{dy}{dt} + y = 0$$

These are the equations of motion for a damped harmonic oscillator.

Time (t)	x(t)	y(t)
0	1.000	1.000
0.5	0.787	0.787
1.0	0.607	0.607
1.5	0.472	0.472
2.0	0.371	0.371
2.5	0.290	0.290
3.0	0.230	0.230
3.5	0.183	0.183
4.0	0.147	0.147
4.5	0.118	0.118
5.0	0.094	0.094

These are the values of x and y at various times.

The following table shows the values of x and y at various times.

Time (t)	x(t)	y(t)
0	1.000	1.000
0.5	0.787	0.787
1.0	0.607	0.607
1.5	0.472	0.472
2.0	0.371	0.371
2.5	0.290	0.290
3.0	0.230	0.230
3.5	0.183	0.183
4.0	0.147	0.147
4.5	0.118	0.118
5.0	0.094	0.094

$$\frac{d^2x}{dt^2} + \frac{dx}{dt} + x = 0$$

$$\frac{d^2y}{dt^2} + \frac{dy}{dt} + y = 0$$

These are the equations of motion for a damped harmonic oscillator.

The following table shows the values of x and y at various times.

Time (t)

Table 9 Radiant Intensity of Diffusion Flames in Wavelength Regions Below 2.5 microns

Fuel	Fuel Consumption lb/min	Wind Velocity mi/hr	Radiant Intensity watts/steradian	Yellow to Blue Ratio*
Liquid Fuels in Six-inch Burner				
Gasoline	0.053	0	0.21	10.
Gasoline	0.16	20	1.5	2.9
Hydramic--	0.017	0	3.2x10 ⁻³	237
-fluid	0.072	20	9.5x10 ⁻²	303
Lubricating--	0.025	0	8.7x10 ⁻³	25
-oil	0.030	10	5.0	5.7
11100				
Natural Gas in 1.13/16" Burner				
Natural Gas	0.035	0	0.29	7.6
natural Gas	0.020	0	0.18	6.1
Natural Gas	0.0035	0	0.14	4.3
Natural Gas	0.0024	0	0.033	11.

*The ratio of radiant intensity in the yellow end of the spectrum (0.55 to 0.70 micron) to that in the blue end (0.41 to 0.55 micron).

1. The first of the following is a list of the names of the people who were present at the meeting on the 15th of the month.

Mr. A.	Mr. B.	Mr. C.	Mr. D.	Mr. E.	Mr. F.	Mr. G.	Mr. H.	Mr. I.	Mr. J.
Mr. K.	Mr. L.	Mr. M.	Mr. N.	Mr. O.	Mr. P.	Mr. Q.	Mr. R.	Mr. S.	Mr. T.

The names of the people who were present at the meeting on the 15th of the month are listed in the table above.

Mr. A.	Mr. B.	Mr. C.	Mr. D.	Mr. E.	Mr. F.	Mr. G.	Mr. H.	Mr. I.	Mr. J.
Mr. K.	Mr. L.	Mr. M.	Mr. N.	Mr. O.	Mr. P.	Mr. Q.	Mr. R.	Mr. S.	Mr. T.

The names of the people who were present at the meeting on the 15th of the month are listed in the table above.

Mr. A.	Mr. B.	Mr. C.	Mr. D.	Mr. E.	Mr. F.	Mr. G.	Mr. H.	Mr. I.	Mr. J.
Mr. K.	Mr. L.	Mr. M.	Mr. N.	Mr. O.	Mr. P.	Mr. Q.	Mr. R.	Mr. S.	Mr. T.

The names of the people who were present at the meeting on the 15th of the month are listed in the table above.

The names of the people who were present at the meeting on the 15th of the month are listed in the table above.

Mr. A.	Mr. B.	Mr. C.	Mr. D.	Mr. E.	Mr. F.	Mr. G.	Mr. H.	Mr. I.	Mr. J.
Mr. K.	Mr. L.	Mr. M.	Mr. N.	Mr. O.	Mr. P.	Mr. Q.	Mr. R.	Mr. S.	Mr. T.

The maximum value of radiant intensity observed in the ultraviolet region between 0.30 and 0.41 micron was 3.1 watts/steradian for a stoichiometric mixture of gasoline and air in jet burner no. 2. The radiant intensity in all the other flames, except one, was greater than the minimum detectable amount, 10^{-5} watt/steradian in this wavelength region.

The maximum value of radiant intensity observed in the blue end of the visible spectrum between 0.41 and 0.55 micron was 1.9 watt/steradian for a stoichiometric mixture of gasoline and air in jet burner no. 2. The minimum value observed in this range was 2.9×10^{-3} watt/steradian.

In the yellow end of the visible spectrum, between 0.55 and 0.70 micron, the maximum value of the radiant intensity observed was 5.2 watts/steradian for a flame produced by burning hydraulic fluid in a 20 mph wind. It was less than the minimum detectable amount, 10^{-3} watt/steradian, with the lean premixed flames of gasoline and air and, less than 10^{-4} watt/steradian, with the blue bunsen flame*.

In the infrared portion of the spectrum between 0.7 and 2.5 microns the maximum value of the radiant intensity observed was 303 watts/steradian for a flame produced by burning hydraulic fluid in a 20 mph wind. The minimum value observed was 7.4 watts/steradian for the blue bunsen flame.

The results given in Tables 8 and 9 show that the amount of energy radiated by any of the flames in the ultraviolet and visible portions of the spectrum is small compared to that in the infrared portion out to 2.5 microns. The results reported for the normal radiance in previous tables show that the amount of energy radiated by any of the flames in all wavelengths out to 2.6 microns was less than 50 percent of the total.

The ratio of the amount of energy radiated in the yellow portion of the spectrum to that in the blue portion is shown in the last column of Tables 8 and 9 for each of the flames. Although this ratio is not a complete color specification for a flame, it does give some idea of the color of the flame. This ratio for daylight is roughly one.

3.2 The Flicker of Flames

The preceding section dealt with the average values of radiance and radiant intensity. In this section the fluctua-

*The minimum detectable radiant intensity depended upon the viewing distance which was adjusted to keep the responses of all cells within the limits of linearity.

tions in the radiant intensity will be considered. For convenience, this fluctuation will be called flicker. As a result of stroboscopic studies of bunsen flames, Martley [54] reported in 1932, "the variations in the cross-sectional area of such flames throughout their lengths, and their appearance, suggest a periodic change in velocity of the upwards flowing combustible gas stream and a thickening of the burning layer of the outer cone." The periodic flicker of most flames was confirmed by high speed cinematography and associated measurements which revealed not only variations in the velocity of the gas stream but variations in temperature and projected area. Measurements made on consecutive pictures of flames taken at high speeds indicate that the variations in projected area may account for a large part of the flicker of flames. A series of pictures taken 1/64th of a second apart depicting the appearance of a gasoline flame in the six inch burner throughout two cycles of flicker is shown in Fig. 17.

The variations in the radiant intensity in five wavelength regions within the range from 0.235 to 2.5 microns, recorded simultaneously with a 40 cps oscillatory timing trace, are shown in Fig. 10. The wavelength regions were the same as those used in the studies reported in the preceding section. In this figure, it may be seen that the radiant intensity in the five wavelength regions fluctuated with practically the same fundamental frequency. The saw-tooth component in the trace for the far ultraviolet region appeared because the radiant intensity was so low that the signal approached the noise level of the system. Since the flicker frequency was found to be essentially the same in the five wavelength regions, the flicker frequency was determined for one region only. The infrared cell was used because it provided the largest output signal. The frequency response of the infrared radiometric system was determined by measuring the response at known frequencies produced by a steady infrared source and a sector disc. The response was found to be essentially constant throughout the interval from 1 to 50 cps, 85 percent at 133 cps, and 30 percent at 1700 cps. Thus the response was practically flat for the frequencies generally found in the flicker of flames. The frequency responses of the remaining four radiometric systems were taken to be flat over the frequency range of interest.

The frequency of the periodicity of the flicker was determined by analyzing the output of the spectroradiometer with a wave analyzer, a General Radio Type 762-B Vibration Analyzer having a frequency range from 2.5 to 750 cps, shown at C in Fig. 4. When a flame was being viewed by the cell and the analyzer was tuned to a certain frequency, it indicated the

The first part of the document discusses the importance of maintaining accurate records of all transactions. It emphasizes that every entry should be supported by a valid receipt or invoice. The text also mentions the need for regular audits to ensure the integrity of the financial data. Furthermore, it highlights the role of the accounting department in providing timely and accurate information to management for decision-making purposes. The document concludes by stating that adherence to these principles is essential for the long-term success and stability of the organization.

The second part of the document details the specific procedures for handling cash and credit transactions. It outlines the steps for recording sales, including the issuance of invoices and the recording of revenue. The text also covers the process of collecting payments and the handling of discounts. Additionally, it discusses the importance of reconciling bank statements and maintaining a clear audit trail for all cash flows. The document provides a comprehensive overview of the accounting cycle, from the initial journal entries to the final closing entries. It stresses the need for consistency and accuracy in all accounting practices to ensure reliable financial reporting.

The final part of the document addresses the ethical responsibilities of accountants. It discusses the importance of honesty, integrity, and objectivity in all professional activities. The text also touches upon the need for confidentiality and the avoidance of conflicts of interest. It concludes by stating that accountants have a duty to uphold the highest standards of professional conduct and to serve the public interest.



FIG. 17 GASOLINE DIFFUSION FLAME IN 6 INCH BURNER. PHOTOGRAPHS
TAKEN AT $\frac{1}{64}$ sec INTERVALS DURING TWO CYCLES OF FLICKER.

amplitude of the cell response at that frequency. As a result of the variability of flames, the indicated amplitude varied about the average value for a given frequency. To facilitate the determination of this average, the analyzer output was recorded on a General Electric Potentiometer recorder, as is indicated in Fig. 5. For each flame, the flicker amplitude was recorded for about 20 seconds at each of about 50 different frequencies between 2.5 and 750 cps. The wave analyses, the average relative amplitude observed for each frequency in the range where there were appreciable amplitudes, are shown for several flames in Figs. 18 to 22.

Such an analysis was made of the flicker of diffusion and premixed flames produced by a bunsen burner and the large gas burner; gasoline, hydraulic fluid, and lubricating oil fires in the six-inch liquid burner both in a closed room and in a wind; and premixed and liquid injection flames in jet burner no. 2.

In many cases the flicker amplitude distribution curves had a sharp maximum at some frequency between 3 and 15 cycles per second. In some cases the peak amplitude was as much as 100 times the average amplitude over the range from 2.5 to 750 cycles per second. In the analysis of some flames that flickered with great regularity, second and third harmonics were observed. These characteristics may be seen in Fig. 18. Some of the flames observed had appreciable flicker amplitude at frequencies above 150 cycles per second. The jet flames were the only ones having any significant part of the distribution above 25 cycles per second. The distributions for the diffusion flames had sharper peaks and higher relative maxima than those for the premixed flames. The most broadly and evenly distributed flicker curves were those for the premixed jet flames, which had maxima only 3 or 4 times the average over a 100 cycle per second band as is shown in Fig. 19. A ten or twenty mile per hour wind increased the amplitude and frequency of flicker of flames burning on the surface of liquids, as is shown in Figs. 20, 21, and 22. The principal flicker maxima were at frequencies between 3 and 10 cycles per second for flames on liquids, 5 and 10 cycles per second for the gas flames, and 5 to 25 cycles per second for the jet flames.

In addition to the wave analyses of flame flicker, the ratio of flicker to the average radiant intensity was measured. This quantity was obtained by measuring the root-mean-square value of the alternating component and the average direct component of the output of the spectroradiometer and taking their ratio. For burning liquids, this quantity ranged from 0.25 for

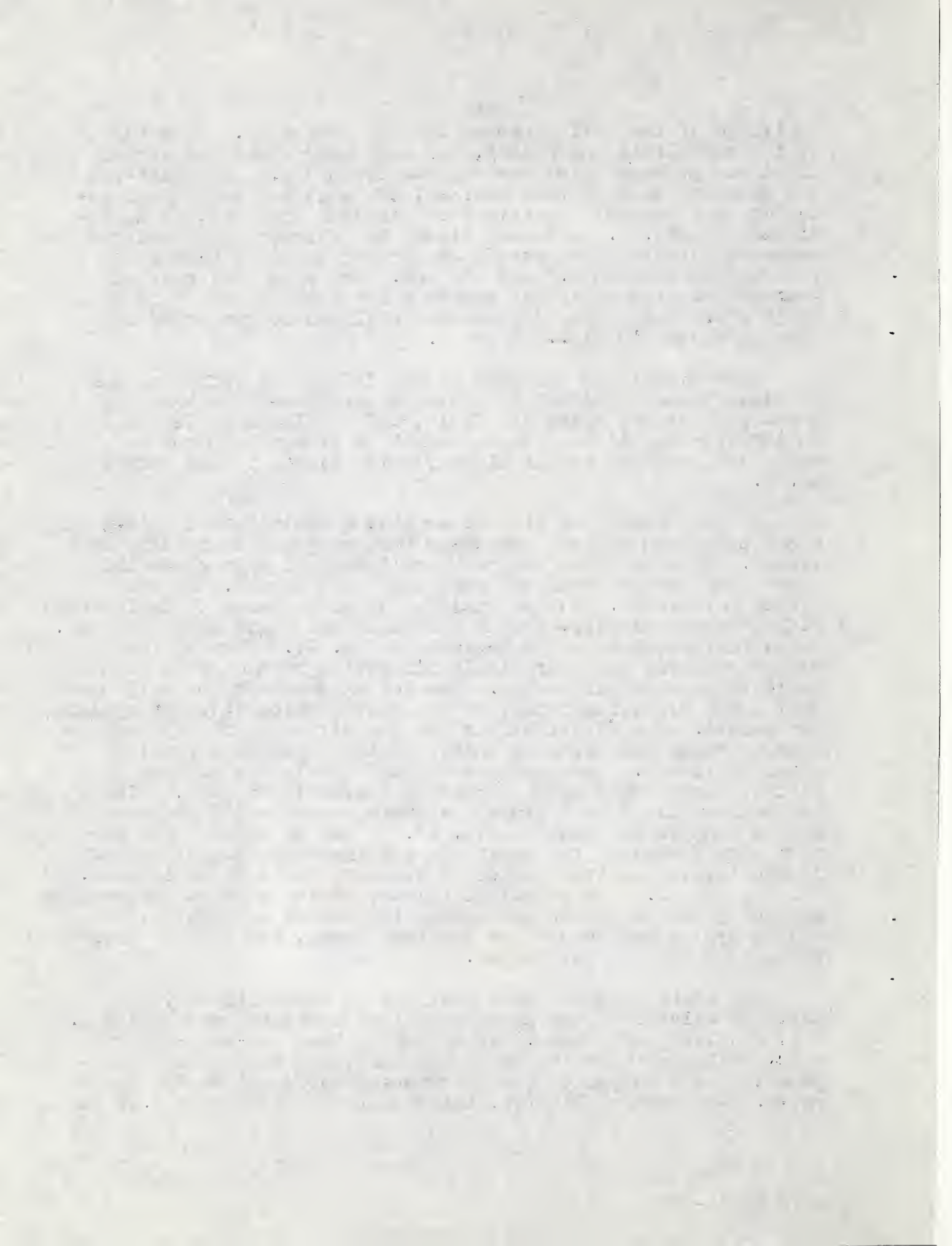

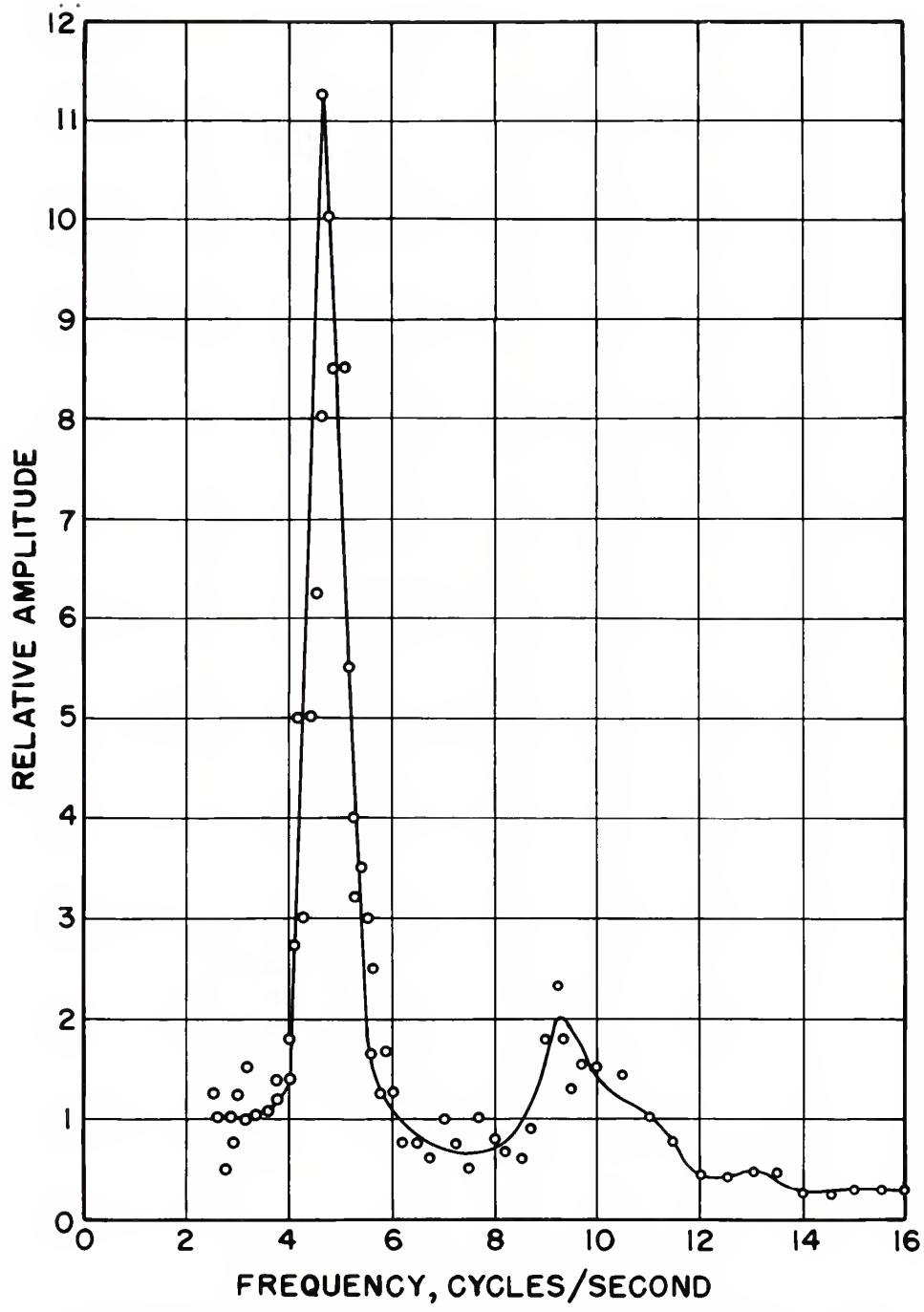

FIG. 18 WAVE ANALYSIS OF NATURAL GAS
DIFFUSION FLAME

24161

9

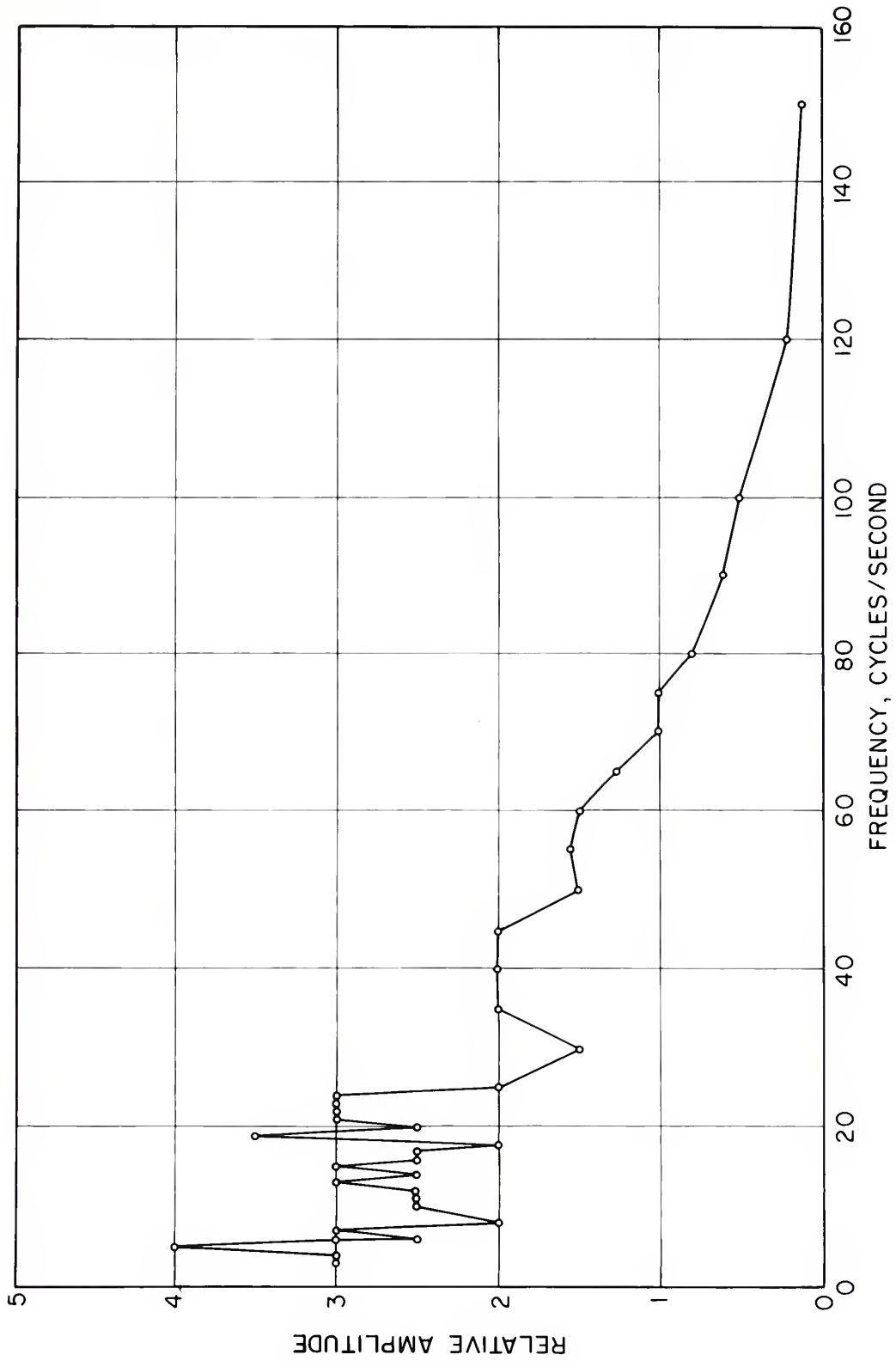

FIG.19 WAVE ANALYSIS OF RAM JET BURNER FLAME

24161 10

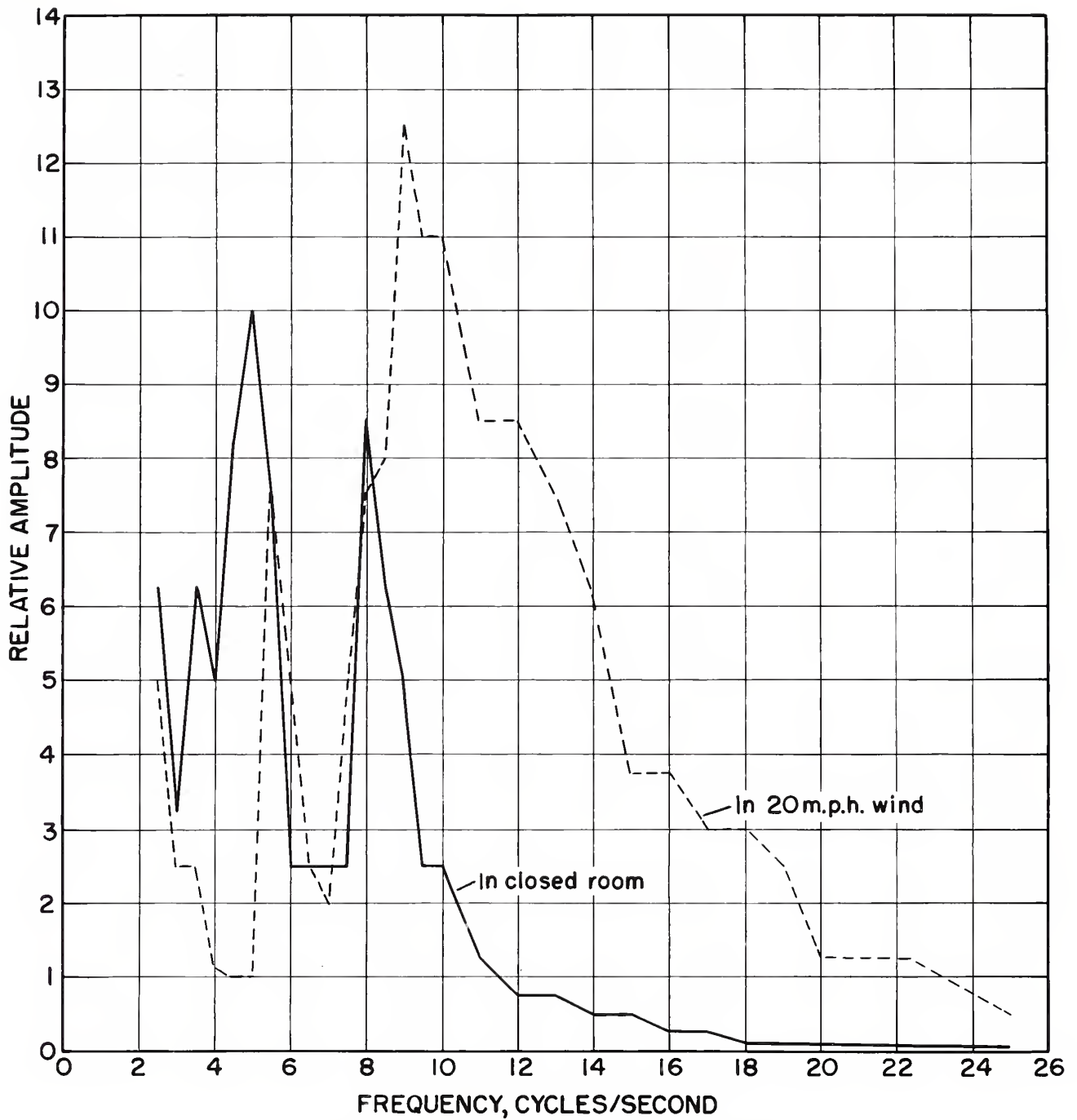

FIG. 20 WAVE ANALYSIS OF GASOLINE
DIFFUSION FLAME

24161 11

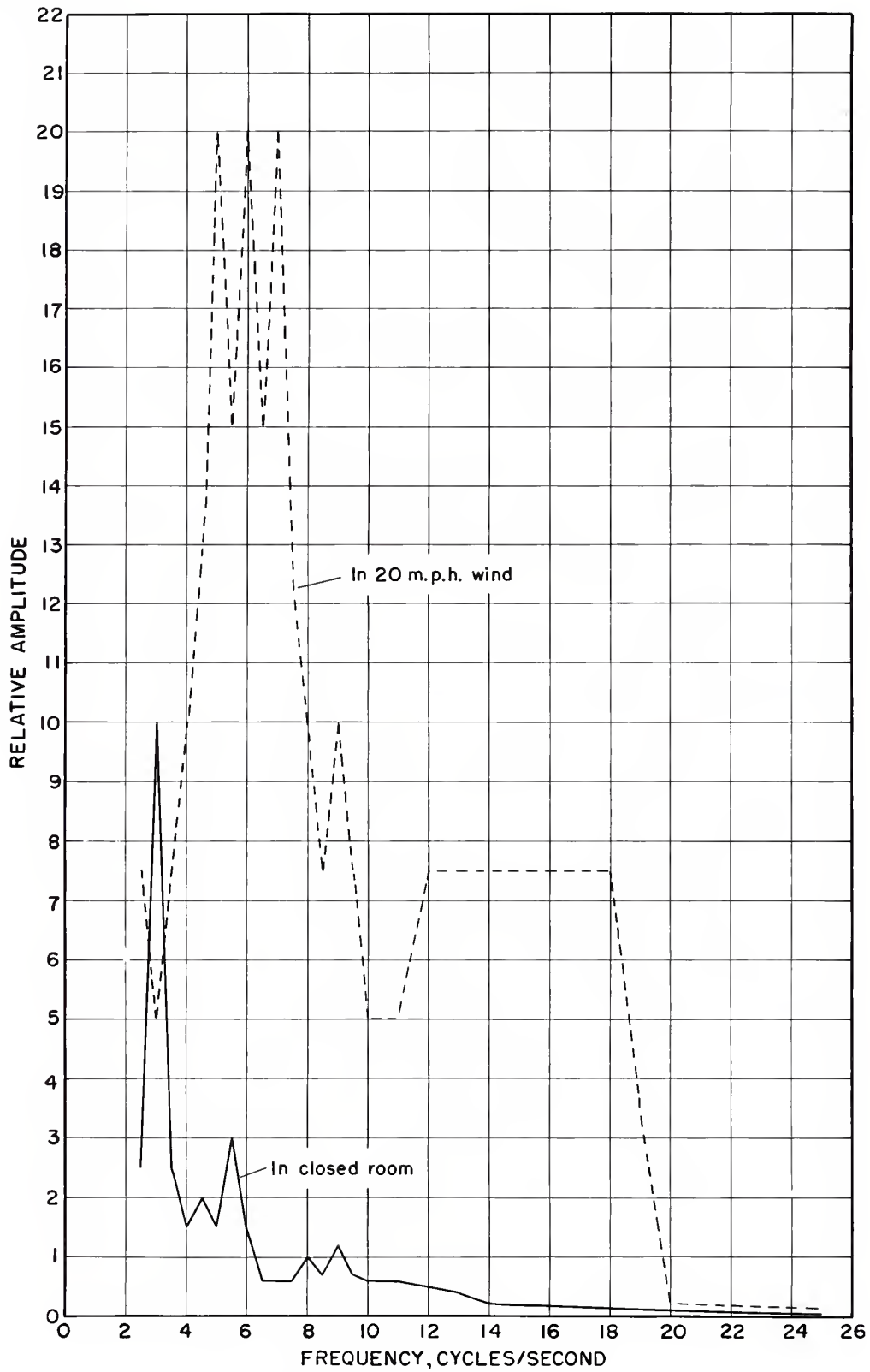

FIG. 21 WAVE ANALYSIS OF HYDRAULIC FLUID
DIFFUSION FLAME

24161 12

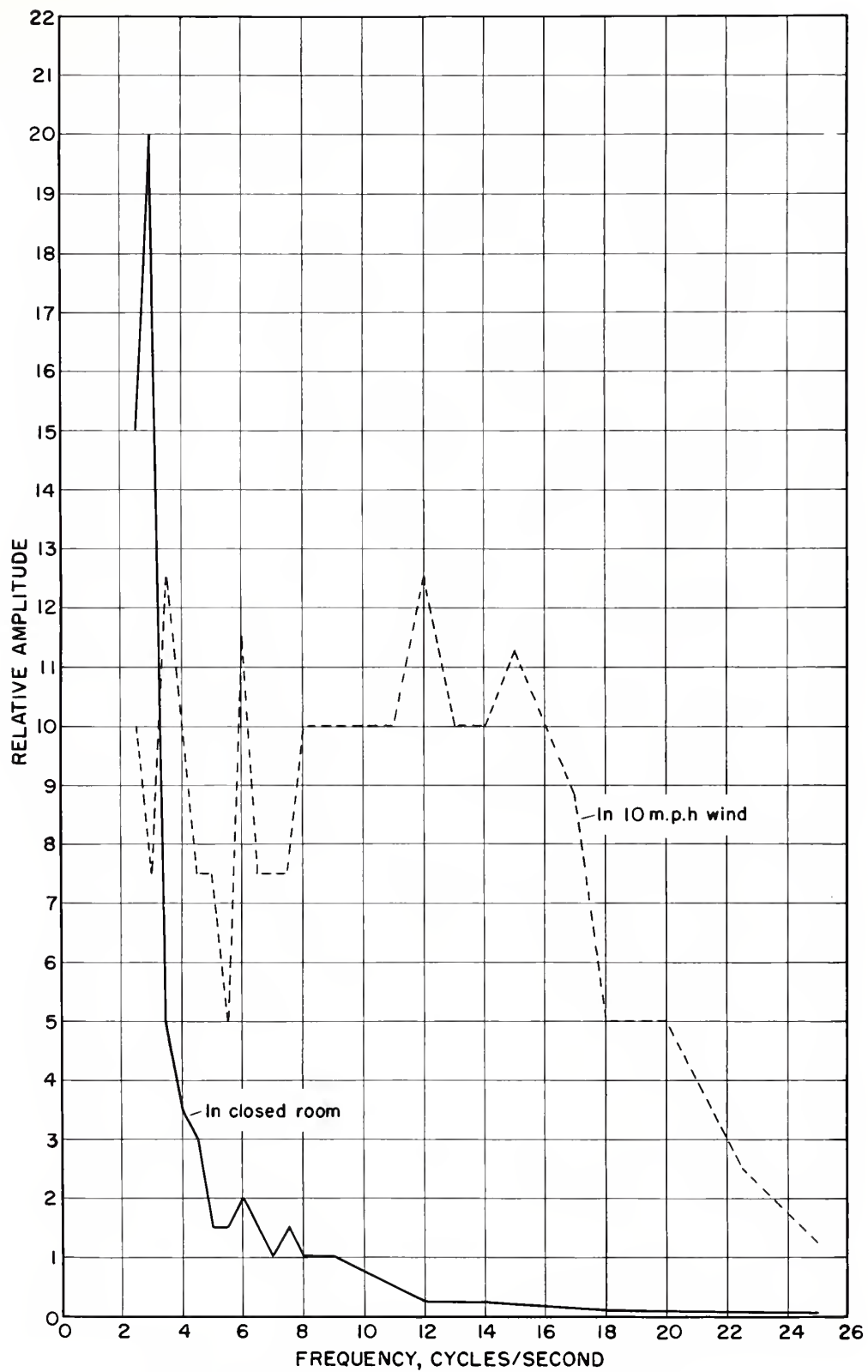

FIG. 22 WAVE ANALYSIS OF LUBRICATING OIL
DIFFUSION FLAME

24161 13

a gasoline fire in a closed room to 0.41 for a hydraulic fluid fire in a 20 mph wind. For natural gas flames, this ratio ranged from 0.08 for a steady low-velocity blue premixed flame to 0.69 for a small diffusion flame. The ratio ranged from 0.05 to 0.15 for premixed jet flames but became 0.1 to 0.3 for the flames in which liquid fuel was injected.

3.3 Rate of Change in Radiant Flux

In the preceding section, it was shown that the variations in the radiant intensity of the flames were very similar in each of the wavelength regions studied. Consequently, determinations of the rate of increase in the radiant intensity from the instant of ignition were made in only one wavelength region, 0.7 to 2.5 microns. Determinations were made with diffusion flames of gasoline and of hydraulic fluid in the 6 in. diameter burner. Oscillograph recordings of the radiant intensity were used for this purpose.

Figure 23 shows a typical record of the radiant intensity of a gasoline diffusion flame from the instant of ignition, together with a 40 cps timing trace. The radiant intensity of the gasoline fires increased to a first maximum value in about 0.2 second and that of hydraulic fluid fires increased to a first maximum value in about 0.3 second. After reaching the first maximum value, in each case, the radiant intensity began to fluctuate. In some cases, each succeeding maximum increased for about 2 seconds, with the maximum value after 2 seconds being about 1.4 times the first maximum. This increase after the first maximum was attributed to an increased rate of evaporation of the liquid fuel upon heating.

In general, the value of the first recorded maximum value was approximately equal to or greater than the average steady state value. Consequently, the approximate average rate of increase in the radiant intensity or normal radiance in any wavelength region may be obtained by dividing the average values reported in the previous sections by 0.2 or 0.3.

Since the time constant of the commercial radiation pyrometer receiver was about 0.5 second, it was not suitable for determining the more rapid increase in the normal radiance of a flame. However, some measurements were made of the rate of increase in the indication of this receiver as recorded by a General Electric Recording Potentiometer. The recorder indicated a first maximum value in about 0.7 second after the ignition of liquid gasoline. Consequently, the rate of increase in the radiant intensity of a flame immediately following its initiation and the rate of response of commercial receivers are sufficient to permit the detection of a fire in less than one second.

1. The first part of the document is a letter from the Secretary of the State to the President, dated 18th March 1847. It contains a report on the state of the country and the progress of the war.

2. The second part of the document is a report from the Secretary of the State to the President, dated 18th March 1847.

The report contains a detailed account of the military operations and the state of the country. It also mentions the progress of the war and the state of the country.

The report also mentions the progress of the war and the state of the country. It also mentions the progress of the war and the state of the country.

The report also mentions the progress of the war and the state of the country. It also mentions the progress of the war and the state of the country.

The report also mentions the progress of the war and the state of the country. It also mentions the progress of the war and the state of the country.

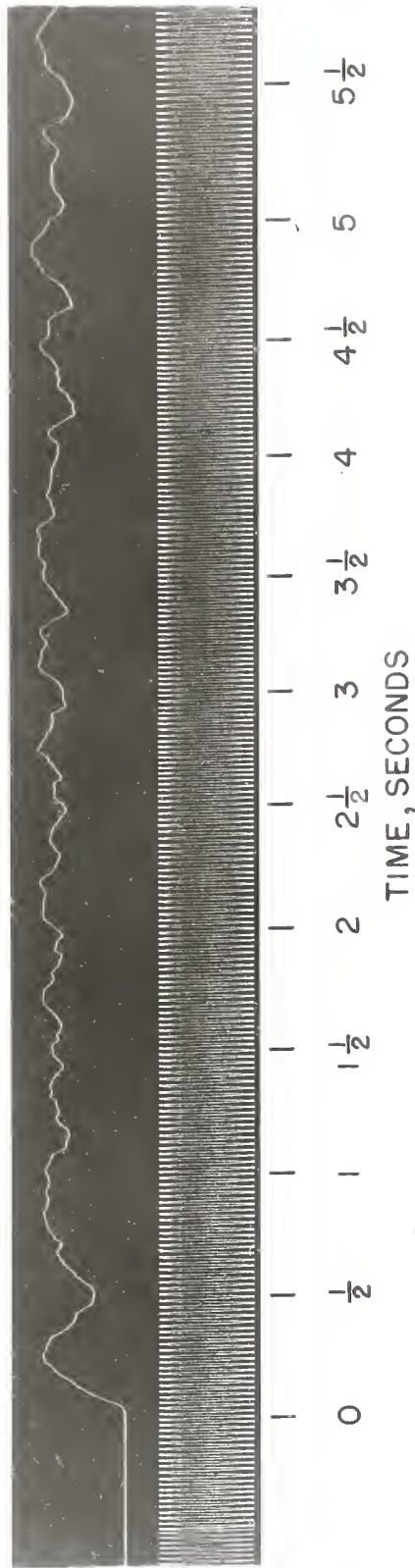

FIG. 23 OSCILLOGRAPH RECORD OF RADIANT INTENSITY OF A GASOLINE
DIFFUSION FLAME FROM THE TIME OF IGNITION AND A 40 cps
TIMING TRACE

24161-14

SECTION IV

CONTACT HEATING EFFECTS

Many of the fire detecting systems that have been proposed for use in aircraft depend upon a flame contacting some temperature sensitive element and heating it to some predetermined temperature level or at a rate greater than that encountered in normal operation. The results of performance tests on the more practicable of these systems under simulated flight conditions have been reported. [1,2,3,4,5,12,13,64] Consequently, this section of the report will be confined to the general considerations of the factors involved in the heating of temperature sensitive elements by flames.

When a small object such as the temperature sensitive element of a fire detecting device at a temperature, T_1 , is contacted by a hot gas or a flame at a temperature, T_g , it will eventually come to some steady state temperature, T_2 , at which it gains and loses heat at equal rates. This steady state temperature is seldom identical to either the temperature, T_g , or the temperature, T_w , of the surroundings. Since time is an essential factor in detecting and extinguishing fires, the steady state temperature attained by the temperature sensitive element exposed to a fire is not, in itself, of particular interest because this condition may not be attained in less than several seconds or minutes. The factor which is of interest is the time required for the sensitive element to reach some predetermined temperature or in other words the rate at which its temperature is increased.

The rate at which the temperature of a sensitive element changes from T_1 to T_2 is a function of its surface area (A), mass (M), heat capacity per unit mass (C), and the rate of heat transfer with the surroundings. This may be expressed as follows

$$dT/dt = (A/MC) f(h, T, T_g, T_w) \quad (1)$$

where T is its temperature at time, t , after its environment is changed, and h is a generalized heat transfer coefficient such that $f(h, T, T_g, T_w)$ describes completely the heat transfer to and from the element. This heat-transfer function depends upon the dimensions and thermal properties of the temperature sensitive element as well as upon the environmental conditions. Although this function has not been evaluated theoretically for any general case, certain simplifying assumptions permit a solution which gives a quantity that is a measure of the rate of heating or cooling of an element under specified conditions.

CONFIDENTIAL

... ..

... ..

... ..

... ..

(S) (U) (C) (E) (R) (T) (I) (O) (N) (L) (Y) (S) (E) (C) (R) (E) (T)

... ..

If h is assumed a constant for a given set of conditions (this implies that Newton's law of cooling applies) and if the rate of heat transfer from the element to the walls by radiation and conduction is small compared to the rate of heat transfer from the flame to the element by convection and conduction, then $T_g = T_2$ and T_w can be neglected. Equation (1) then becomes

$$\frac{dT}{dt} = \frac{Ah}{MC} (T_2 - T) \quad (2)$$

The solution of this equation [75] gives

$$(T-T_1)/(T_2-T_1) = 1 - e^{-t/L} \quad (3)$$

where e is the base of the naperian logarithm system and $L = MC/Ah$. When $t = L$

$$(T-T_1)/(T_2-T_1) = 1 - 1/e = 0.632 \quad (4)$$

Thus L is the time required for the element to undergo 63.2 percent of the total change in temperature to which it is subjected instantaneously. The time L so defined is generally referred to as the "time constant" of the element.

Since M , C , and A are constants for any given element, L is inversely proportional to the heat transfer coefficient h which varies in a complex manner depending upon the environmental conditions. However, analyses of available data indicate that, for a given element, h is essentially dependent on the mass velocity of the flame products or hot gases to which the element is exposed. Thus, the time constant of an element exposed to a flame or moving gas is independent of the temperature and of the temperature difference to which it is subjected, and the same value of L applies whether the object is being heated or cooled. For elements exposed to flowing gases, a numerical value of the time constant is significant only when the mass velocity is given.

It should be pointed out that the above analysis does not hold if the predominate mode of heat transfer is by radiation. In the latter case the time constant depends also upon the temperature level, the temperature interval, and upon whether the element is being heated or cooled. (See Ref. [75]).

In either case the time constant of an element is directly proportional to the total heat capacity (MC) and inversely proportional to the surface area. Consequently, any method of increasing the ratio of the surface area to the total heat capacity will reduce L , but such means of reducing L are practicable only within the limits established by the ability of the element to withstand the stresses to which it is subjected.

It is assumed a constant for a given set of conditions (this initial condition is not a function of time) and it is assumed that the transfer function is constant for the whole of the time interval. It is assumed that the transfer function is constant for the whole of the time interval. It is assumed that the transfer function is constant for the whole of the time interval.

$$(1) \quad \frac{d^2x}{dt^2} + 2\frac{dx}{dt} + x = 0$$

The solution of the differential equation is

$$(2) \quad x(t) = e^{-t} \cos t$$

where x is the displacement of the particle in the vertical direction and t is the time.

$$(3) \quad \frac{d^2x}{dt^2} + 2\frac{dx}{dt} + x = 1$$

where x is the displacement of the particle in the vertical direction and t is the time. The solution of the differential equation is $x(t) = 1 - e^{-t} \cos t$.

The solution of the differential equation is $x(t) = 1 - e^{-t} \cos t$. The solution of the differential equation is $x(t) = 1 - e^{-t} \cos t$. The solution of the differential equation is $x(t) = 1 - e^{-t} \cos t$. The solution of the differential equation is $x(t) = 1 - e^{-t} \cos t$. The solution of the differential equation is $x(t) = 1 - e^{-t} \cos t$.

The solution of the differential equation is $x(t) = 1 - e^{-t} \cos t$. The solution of the differential equation is $x(t) = 1 - e^{-t} \cos t$. The solution of the differential equation is $x(t) = 1 - e^{-t} \cos t$. The solution of the differential equation is $x(t) = 1 - e^{-t} \cos t$.

The solution of the differential equation is $x(t) = 1 - e^{-t} \cos t$. The solution of the differential equation is $x(t) = 1 - e^{-t} \cos t$. The solution of the differential equation is $x(t) = 1 - e^{-t} \cos t$. The solution of the differential equation is $x(t) = 1 - e^{-t} \cos t$.

Since the time constant of a temperature sensitive element depends upon the environmental conditions, as well as the physical characteristics of the element itself, these conditions must be taken into consideration in devising any method for determining it or any other quantity related to it. Since seconds and fractions thereof are important in fire detection, the time lag in the actuating system must also be considered. Consequently, Dallas and Hansberry [1], Pignan [2], Hansberry [3], Tarbell [5], and others have reported the over-all operational time of various types of fire detecting systems as determined in fire tests simulating flight conditions. Some of these investigators have also reported the temperatures attained by the bare junctions of #18 gage chromel-alumel thermocouples located in the fire zones. A laboratory test for determining the operational time of fire detectors was then devised, utilizing a bunsen flame adjusted to give the same temperature (as measured with the same type and size of thermocouple) and the same operational time of the fire detectors that was obtained in the full scale tests. Such a laboratory test method for determining the operational time of fire detectors has been incorporated in several U. S. A. F. specifications for fire detectors, [76,77, 78,79], as examples.

When a temperature sensitive element in a steady state condition with its surroundings is suddenly exposed to moving gases at a higher temperature, its initial rate of temperature rise is primarily the result of an increase in the rate at which heat is gained by convection. The same condition applies whether the moving gases are in chemical equilibrium or in a reacting state, as in a flame. McAdams [74] compiled a summary of available data which indicates that the coefficient of heat transfer by convection from a flowing gas to a small wire increases linearly as the 0.52 power of the mass velocity. From this it can be shown that the steady state temperature T_2 , finally attained by a small wire is given approximately by

$$\frac{T_2 - T_w}{T_g - T_w} = \frac{a + b \sqrt{G}}{a + b \sqrt{G} + hc + hr} \quad (5)$$

where a , b , c , and d are positive constants, G is the mass velocity, h_c and h_r are the coefficients of heat transfer to the walls by conduction and radiation, respectively, and T_g and T_w are the temperatures of the moving gas and the walls respectively. Thus, if T_g and T_w are maintained constant, the steady state temperature, T_2 , will increase with G as long as there is any heat transfer from the element to the walls by radiation or conduction.

The first part of the document discusses the importance of maintaining accurate records of all transactions. It emphasizes that every entry should be supported by a valid receipt or invoice. The text also mentions the need for regular audits to ensure the integrity of the financial data.

In the second part, the author details the various methods used for data collection and analysis. This includes the use of statistical software to process large volumes of information. The document highlights the challenges of data accuracy and the steps taken to minimize errors.

The final section provides a summary of the findings and conclusions drawn from the study. It notes that while there are significant challenges, the use of modern technology and rigorous procedures can lead to more reliable results.

This section describes the specific procedures followed during the data collection phase. It outlines the selection of samples and the methods used to ensure their representativeness. The text also discusses the ethical considerations that guided the research process.

The analysis of the collected data is presented in the following section. It includes a detailed breakdown of the results and an interpretation of their significance. The author discusses the implications of the findings for the field of study.

$$(d) \quad \frac{2x^2 + 3x + 1}{x^2 - 2x + 1} = \frac{2x + 3}{x - 1} + \frac{4}{x - 1}$$

The following section discusses the broader context of the research and its contribution to the existing body of knowledge. It compares the current findings with previous studies and identifies areas for further investigation.

The document concludes with a final statement on the importance of continued research and the role of the researcher in advancing the field.

Dahl and Flock [75] presented a method of determining the time constants of temperature sensitive elements when exposed to moving gases at various temperatures and mass velocities. They also included the results of measurements of the time constants of bare chromel-alumel thermocouples of different sizes. One of the sizes included was #18 gage, the same size and type of thermocouple as used in expressing the temperatures of the flames in the work described earlier.

Since bare #18 gage chromel-alumel thermocouples have been used in so much work on the subject of fire detection, some measurements were made with them in the diffusion type flames used in the present investigation. The time constant determined for a bare #18 gage thermocouple in the flames of burning aviation gasoline in normally still air was 11 seconds. The mass velocity of the burning gases was estimated to be about $0.12 \text{ lb}/(\text{ft}^2\text{-sec})$. A time constant of 6 seconds was obtained for the same thermocouple when the burning gasoline was placed in a 20 mph wind. The mass velocity of the burning gases in this case was estimated to be about $0.37 \text{ lb}/(\text{ft}^2\text{-sec})$. These values together with those obtained by Dahl and Flock for the same size thermocouple in gases at much higher mass velocities are plotted in Fig 24 on a log-log scale.

According to this curve the time constant decreases linearly as the 0.55 power of the mass velocity. Consequently, the generalized heat transfer coefficient, h , referred to earlier increases as the 0.55 power of the mass velocity. In addition to the bare thermocouple junctions, Dahl and Flock also studied the heating characteristics of a variety of temperature sensitive elements encased in metal and ceramic protection tubes and imbedded in insulating materials such as quartz and beryllia. They found that, in general, the time constants of all such sensing elements varied with the mass velocity in the same manner as the bare thermocouple junctions.

The steady state temperature attained by the thermocouple junction in the flames with a mass velocity of $0.12 \text{ lb}/(\text{ft}^2\text{-sec})$ was about 900° F above the ambient temperature. In the case of the flames with a mass velocity of $0.37 \text{ lb}/(\text{ft}^2\text{-sec})$, the steady state temperature attained was about 1000° F above the ambient. The higher temperatures recorded in the nacelles of aircraft during fire tests under simulated flight conditions were probably caused by higher ambient temperatures and mass velocities.

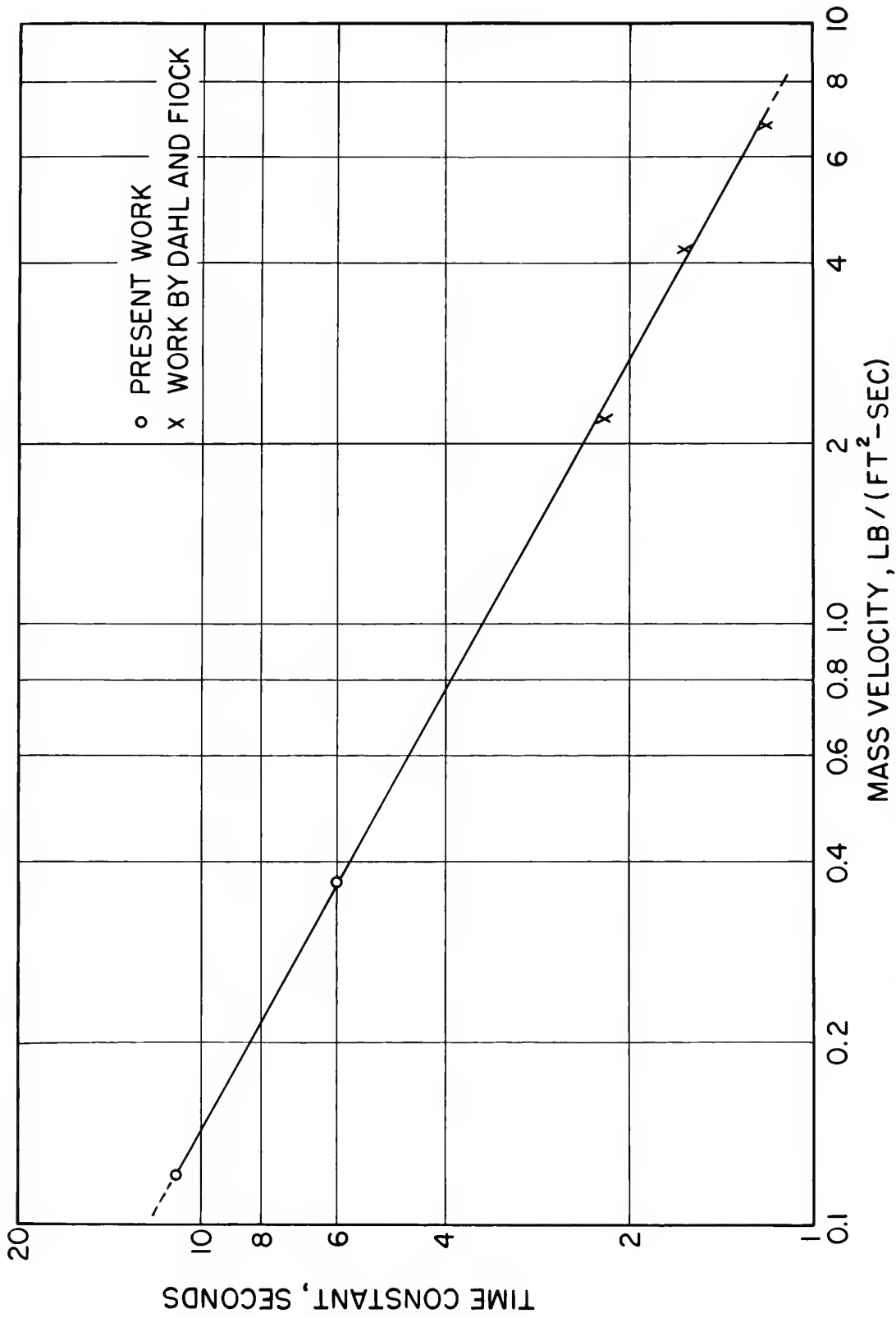

FIG. 24 TIME CONSTANT AS A FUNCTION OF MASS VELOCITY
 18 GAUGE BARE CHROMEL - ALUMEL THERMOCOUPLE

24161 15

The steady state temperatures attained by the junction of an iridium/iridium-rhodium thermocouple (0.035 in diameter wires) in the jet burner flames ranged from 2090° to 3390° F depending primarily upon the fuel-air ratio and the rate of fuel consumption. No attempt was made to determine the time constant of this element in these flames.

SECTION V

FLAME CONDUCTION

It has been known for some time that flames conduct electricity. The electrical characteristics of flames were of considerable interest to experimental physicists at the beginning of this century, since flames provided useful conditions for studying the behavior of gaseous ions. A large part of the early work, reported by Lenard [68], Wilson [69,70], and Andrade [71,72], was concerned with variables or conditions not pertinent to the problem of fire detection. Therefore, experiments were made to determine the factors effecting electrical conduction in flames within the applicable limits of the important variables. Among the factors investigated were the applied potential difference, the distance between electrodes, the area of the electrodes immersed in the flames, the nature of the flames, and the polarity.

The equipment represented in Fig 25 was used to observe the effects described below.

When two wire electrodes 0.04 inches in diameter were placed parallel, $\frac{1}{4}$ inch apart in the outer cone of a blue bunsen flame, the current increased practically linearly from 0.1 to 0.7 microampere as the potential difference was increased from 100 to 500 volts. The current, for any given experimental arrangement, was not changed appreciably by changing the fuel-air ratio of blue bunsen flames. The current in the yellow bunsen flames also varied approximately linearly with the potential difference.

With a similar experimental arrangement, variation of the electrode spacing had little effect on the current if the separation was greater than $\frac{1}{4}$ inch. The current approximately doubled when the separation was reduced from $\frac{1}{4}$ inch to $\frac{1}{8}$ inch and rose sharply as the electrodes were brought still closer together. Before the electrodes came together, an electric arc formed between them and the current became very large. In yellow flames, arcing was often hastened by the rapid accumulation of soot on one of the electrodes, forming a conductive filament between the two electrodes.

The current was approximately proportional to the area of the cathode immersed in the flame but was little effected by variation of the area of the anode. If the electrodes were of different sizes, a larger current was produced when the large electrode was negative than when it was positive. This effect is known as rectification since an alternating potential difference applied to two such electrodes produces a net direct current. The degree of rectification depended upon the ratio of areas of the two electrodes.

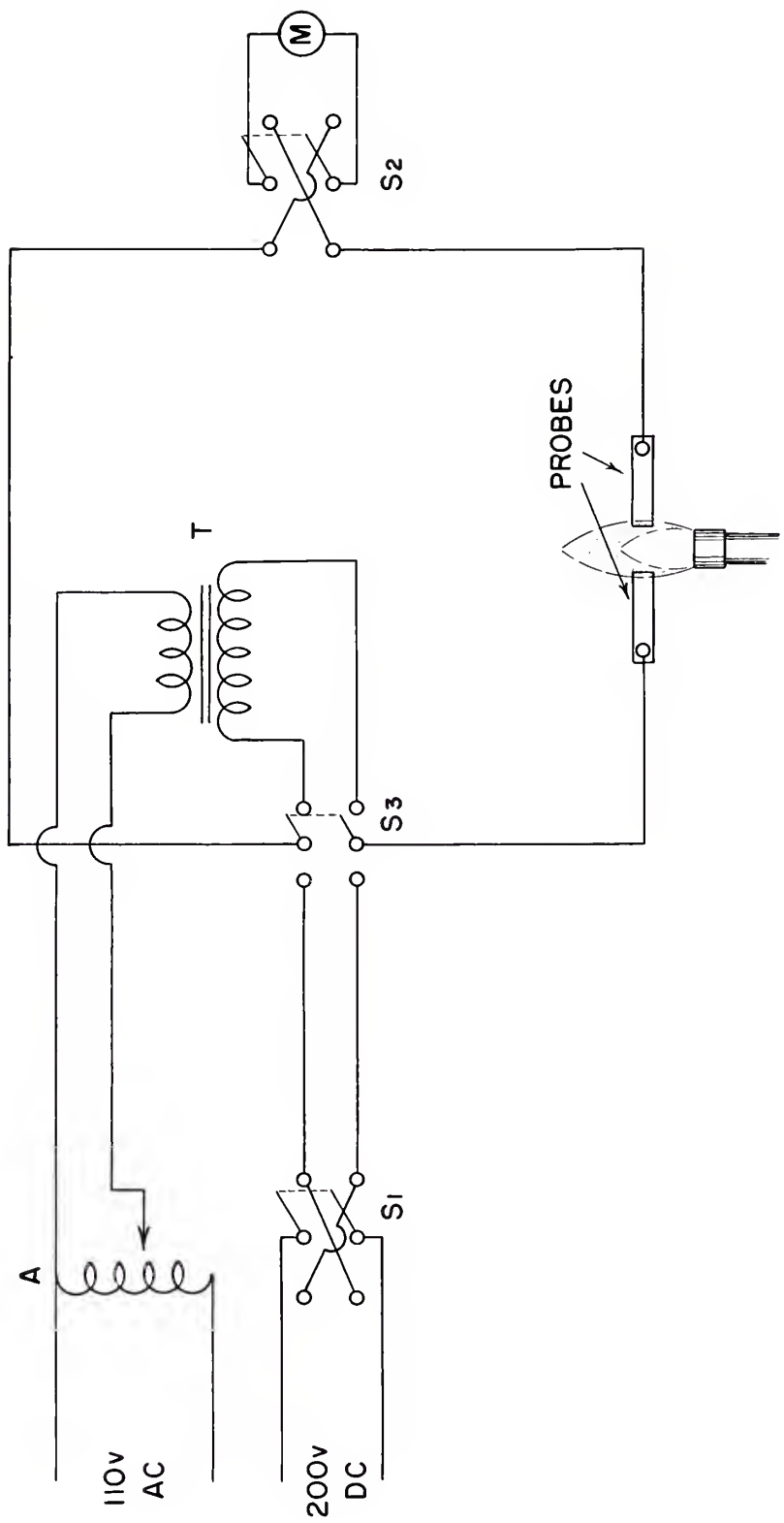

FIG. 25 SCHEMATIC DIAGRAM OF FLAME CONDUCTION APPARATUS

- A = VARIAC
- M = DC MICROAMMETER
- S1, S2 = REVERSING SWITCH
- S3 = AC, DC INPUT SWITCH
- T = STEP UP TRANSFORMER

24161 16

Since the current is a function of cathode area, the current obtained in flames which were not in steady contact with the electrodes varied in magnitude by a factor of about 100.

As a steady blue bunsen flame was moved toward two stationary parallel electrodes $\frac{1}{2}$ inch apart, having a potential difference of 200 volts, current was detected when the visible part of the flame was $\frac{3}{4}$ inch from the electrodes.

No significant differences were observed in the conduction of flames when different metals were used for the electrodes. It was noted that the currents produced when the probes were glowing were greater than those obtained under similar circumstances before the probes began to glow.

Diffusion flames conducted up to three times as much current as blue bunsen flames under similar conditions. In one experiment, 50 inches of $\frac{1}{16}$ inch stranded stainless steel aircraft control cable coiled into a 4 inch flat loop was used as the anode and the 6 inch steel burner was used as the cathode. When gasoline was burned, a potential difference of 500 volts was applied, and the loop was horizontal in the flame with one part within $\frac{1}{8}$ inch of the upper edge of the burner, a current of about 50 microamperes was obtained. When the loop was moved to about two inches above the burner edge, the current fluctuated around 15 microamperes.

1. The first part of the report is a summary of the work done during the year. It is divided into three sections: (a) the work done in the laboratory, (b) the work done in the field, and (c) the work done in the office.

2. The second part of the report is a detailed account of the work done in the laboratory. It is divided into three sections: (a) the work done in the laboratory during the year, (b) the work done in the laboratory during the year, and (c) the work done in the laboratory during the year.

3. The third part of the report is a detailed account of the work done in the field. It is divided into three sections: (a) the work done in the field during the year, (b) the work done in the field during the year, and (c) the work done in the field during the year.

4. The fourth part of the report is a detailed account of the work done in the office. It is divided into three sections: (a) the work done in the office during the year, (b) the work done in the office during the year, and (c) the work done in the office during the year.

SECTION VI

EVALUATION OF METHODS OF DETECTING FIRES

6.0 It should be possible to utilize in a fire detecting system any characteristic of a flame that can be measured. However, if the fire detecting system is to fulfill the essential requirements of the USAF, some of the characteristics of a flame that might be utilized appear entirely impractical. Some characteristics of flames that might be utilized to good advantage in one type of engine compartment might not be suitable in another. Conditions in different types of aircraft engines and engine compartments are so diverse that it is doubtful that the USAF requirements of minimum weight, volume, etc., can be met with a single universal fire detecting system, even though this might be very desirable.

There are certain basic characteristics of a fire detecting system that are absolutely essential and others that are extremely desirable to the USAF. One essential requirement is that the system shall be completely dependable in its operation when subjected to the environmental and operational conditions encountered in Air Force aircraft in world-wide operations. By being completely dependable, it is meant that the system shall indicate fire when, and only when, a fire exists and that it shall indicate "fire-out" when, and only when, the fire is completely extinguished. In order for a system to be completely dependable it must be able to distinguish between a small localized fire and a general increase in the ambient temperature throughout the fire zone. It is also meant that the system shall be capable of withstanding at least one complete fire of the most severe intensity which might normally occur and still be in condition to operate should another fire occur in the same location. The operational conditions involve temperatures of at least 600°F, and possibly 1000°F, in the engine compartments.

Another essential requirement is that the system shall operate, both in signalling "fire" and "fire-out", within a reasonable time. Three seconds appears to be a reasonable time but a system that would operate in 2 seconds or less would be preferred. Any system that would require more than 5 seconds to signal a fire would be of little value.

It is also essential that the equipment necessary to the operation of the system shall be capable of being developed and packaged for aircraft operation.

It is extremely desirable that the equipment necessary to the operation of the system be light in weight, occupy a minimum of space, and be simple to operate, maintain, and test not only

on the ground but also during flight. It should be possible to install the necessary equipment in such a manner that it will not interfere with normal maintenance and servicing of the component parts of the power plant and that it will not be damaged by such operations.

It is also highly desirable that the fire detecting system be such that it may be installed in any new type of nacelle or engine compartment and adjusted to detect any fire in the compartment without elaborate fire tests. Since some fire detecting systems depend upon the flames contacting a sensing element, a knowledge of the flame paths under all operational conditions is necessary to the effective installation of such a system. This generally involves fire tests under simulated flight conditions for each new type of engine nacelle. Thus, in the selection of a suitable fire detecting system the type of coverage; unit, continuous, or space, provided by each detecting element becomes an important factor.

The fact that a great number of fire detecting systems, operating on different flame characteristics, have been devised and tested during the past 11 years is evidence that no one system appears to have predominant advantages over all others or to meet satisfactorily all the requirements of the USAF. Consequently, it appears advisable to select, by a process of elimination, the system or systems that have the least serious undesirable features.

6.1 Single Shot Detectors

Systems which depend upon the burning of a cord or wick or upon the melting of a fusible link to actuate an alarm do not meet the essential requirement that the system must be able to indicate "fire-out" and be in condition to operate should a second fire occur. Consequently, we need not give any further consideration to fire detecting systems which operate on this principle.

6.2 Products of Combustion

Any fire detecting system which utilizes the products of combustion as an indication of fire in an aircraft engine space would be subject to false alarms from leaks in exhaust lines. In addition, it appears that the equipment required would be heavier and more bulky than desired and that the time lag would be too long. Consequently, we will not give any further consideration to fire detecting systems which operate on this principle.

6.3 Combustible Vapors

Considerable experimental work has been done on the development of a method for detecting combustible vapors in aircraft compartments. Although a prototype instrument which met the requirements for sensitivity, accuracy, and independence of altitude was constructed, it was much heavier, more bulky, and more elaborate than could be tolerated on aircraft. In addition the time lag was about one minute. In spite of the fact that a detecting system that would indicate the presence of combustible vapors before explosive mixtures could accumulate might aid materially in preventing fires, we will not consider it any further here, because we are unable to visualize a suitable system for aircraft.

6.4 Ionization Effects

Fire detecting systems which utilize the abnormally high ionization that exists in the reaction zones of hydrocarbon flames appear very attractive because this effect can be definitely distinguished from any background effects and because of the very rapid response obtained with such systems. However, systems utilizing the conduction and rectification effects of flames have not proven entirely satisfactory in fire tests simulating flight conditions [1,2,3,4,13]. The unsatisfactory results obtained with systems operating on this flame effect have been attributed to: (a) Failure of the system to detect fires under certain conditions, (b) False alarms resulting from low insulation resistance, (c) Indications of "fire-out" when fire still existed in the compartment.

Since systems operating on this flame effect depend upon the flame completing an electric circuit between an electrode and the aircraft structure, failure of the system to detect a fire and indications of "fire-out" when a fire still existed would indicate that the flame path was such that it did not complete the circuit or, if it did, the ionization was not sufficient to operate the circuit. In our experiments it was found that for a given circuit (potential difference, size, and spacing of electrodes) the current varied by a factor of 100 depending primarily upon the area of the cathode contacted by the flame.

It is conceivable that false alarms resulting from low insulation resistance might be avoided by the choice of proper circuitry or by coating the electrode with a porcelain enamel that would have a very high resistance at normal operating temperatures but a sufficiently low resistance to permit the system to

operate at the temperatures attained in a fire. The latter would require two flame effects in order to operate; (a) heating the enamel on the electrode to a temperature high enough to be sufficiently conducting and (b) the ionization effect of the flame. Although this might eliminate false alarms, it would not give any assurance that the system would be completely dependable in indicating fire because its operation depends upon the flame contacting an insulated electrode and the aircraft structure. Another disadvantage of this system is that the electrode or contact cable must be mounted on standoff insulators. The system is, therefore, subject to damage during maintenance operations.

Since ionized flame gases absorb, and sometimes reflect, very high frequency electromagnetic waves, it has been suggested that this principle might be utilized in a fire detecting system. The problem of developing such a system that would operate in any engine compartment, irrespective of size or shape, appears, from our knowledge of the subject, too complex. In addition, it does not appear that such a system would be suitable for use in military aircraft because of possible interference with radar operations and of susceptibility of detection by the enemy.

Since the ionization that exists in a flame is one characteristic that distinguishes it from any background effects, the possibility of utilizing this principle in a fire detecting system should not be completely dismissed simply because we, at the present time, are unable to conceive a practical and reliable system.

6.5 Contact Heating Effect

Most of the fire detecting systems that have been proposed for use on aircraft depend upon a flame contacting some temperature-sensitive element and heating it to some predetermined temperature level or at a rate greater than that encountered in normal operation. Fire tests under simulated flight conditions have been made on those systems that appeared to be the more practical. It has been clearly demonstrated that, for these systems to operate with any degree of dependability, the flame must actually contact the temperature sensitive element. The rate of heating of an element by a flame coming very close to it was insufficient to produce a signal within any reasonable period of time, if at all.

It was pointed out in Section IV that, for any given temperature-sensitive element, the rate of temperature rise increases

with the temperature and the mass velocity of the heated gas surrounding it. Consequently, in order to improve the probability of the flame contacting an element and to increase its rate of response, it must be located in the fire zone and at some distance from the surface from which it is supported. This means that the elements are so located that they are most vulnerable to damage during a fire and during normal maintenance operations. In addition the electrical cable connecting unit type detectors is also subject to fire damage.

It was also pointed out in Section IV that the speed of response of a temperature-sensitive element is also increased by increasing the ratio of the surface area to the total heat capacity. However, the stresses which an element must withstand in normal service as well as during a fire, place a practical limit upon such means of increasing the speed of response.

The probability of a temperature-sensitive element detecting a fire and its speed of response can be increased by designing or adjusting the system to respond to a smaller differential between the heating effects attributable to fire and those attributable to normal operations. However, this method also increases the probability of false alarms due to safe but abnormal operations.

Although the mechanical and electrical features of present fire detecting systems that operate on flame contact might be improved, it is questionable that any such system can be made completely dependable in all engine compartments without elaborate fire tests to determine the flame paths under all operational conditions. Even then, the flame paths may be such as to require more fire detecting elements than can be tolerated.

Any evaluation of fire detecting systems that we might make as a result of our analysis of flame characteristics should not contravene the evaluations of fire detecting systems based upon tests under simulated flight conditions. One of the latest evaluations of this type was made with different fire detecting systems in a Lockheed constitution by L. E. Tarbell [5]. The general results reported by other investigators of similar fire detecting systems in other aircraft are not inconsistent with those reported by Tarbell. The following quotations were taken from this report.

"In general, unit detectors can be used advantageously in small enclosed spaces. In large compartments, unless the units are spaced quite close together, there is a strong possibility that a fire may pass between two adjacent units without causing

where Ω is the solid angle subtended by the source at the receiver, E_λ is the average spectral radiance of the source in the direction of the receiver at wavelength λ , and T_λ is the spectral transmittance of the envelope at wavelength λ . Values of E_λ will vary greatly depending upon the temperature and the nature of the source, and those of T_λ will also vary greatly depending upon the envelope material and the accumulation of foreign material thereon. For the purpose of discussion, it is convenient to approximate equation (6) by the following

$$W = E(\lambda_1 - \lambda_2) \bar{T}(\lambda_1 - \lambda_2) \Omega \quad (7)$$

where $\bar{T}(\lambda_1 - \lambda_2)$ is the average transmittance of the envelope in the wavelength region $(\lambda_1 - \lambda_2)$ determined from the transmittance curve of the envelope and the spectral distribution of the radiant energy of the source and $E(\lambda_1 - \lambda_2)$ is the average radiance of the source in the same wavelength region in the direction of the receiver.

In the same manner, the response, R , of a given receiving element can be written as

$$R = W R(\lambda_1 - \lambda_2) = E(\lambda_1 - \lambda_2) \bar{T}(\lambda_1 - \lambda_2) R(\lambda_1 - \lambda_2) \Omega \quad (8)$$

where $R(\lambda_1 - \lambda_2)$ is the average response per unit of radiant flux density over the wavelength interval $(\lambda_1 - \lambda_2)$ for the distribution of radiant flux established by E_λ and T_λ .

6.6.1.1 Amount of Radiant Flux at Wavelengths Below 0.29 Micron

Although the amount of radiant flux emitted by a flame at wavelengths less than 0.29 micron is extremely small compared to the total emitted at all wavelengths, it is still greater than that in sunlight at the earth's surface and that from any heated parts in engine compartments. Consequently, methods of utilizing the energy emitted by flames in this wavelength region have been very attractive. At the present time, however, there appears to be, at least, one practical disadvantage to any method utilizing the energy emitted in this wavelength region, and that is, the absorption of the radiant energy by oil and grease films on the envelope of the detector.

The transmittance curves for some very thin oil films are shown in Fig. 26. The oil films were formed by covering one

- by all the people of the Republic of China and all the people
 of the world who are interested in the peace and
 prosperity of the East and the West. The Republic of China
 is a democracy and a free society. It is a country
 where the people have the right to speak their minds
 and to express their opinions. It is a country
 where the people have the right to elect their
 representatives and to hold them accountable.
 It is a country where the people have the right
 to live in peace and harmony with their
 neighbors and with all the people of the world.
 It is a country where the people have the right
 to live in freedom and to enjoy the fruits
 of a just and equitable society.

$$(1) \quad (x^2 - 1)(x - 1) = x^3 - 2x^2 + x - 1$$

The above equation is a polynomial equation of degree 3. It can be factored as follows:

$$(x^2 - 1)(x - 1) = (x - 1)(x + 1)(x - 1) = (x - 1)^2(x + 1)$$
 This shows that the equation has three roots: $x = 1$ (with multiplicity 2) and $x = -1$.

The roots of the equation are $x = 1$ and $x = -1$. The root $x = 1$ is a double root, and the root $x = -1$ is a simple root.

$$(2) \quad (x^2 - 1)(x - 1)^2(x + 1)^2 = (x^2 - 1)^2(x - 1)^2$$

The above equation is a polynomial equation of degree 6. It can be factored as follows:

$$(x^2 - 1)(x - 1)^2(x + 1)^2 = (x - 1)(x + 1)(x - 1)^2(x + 1)^2 = (x - 1)^3(x + 1)^3$$
 This shows that the equation has three roots: $x = 1$ (with multiplicity 3) and $x = -1$ (with multiplicity 3).

The roots of the equation are $x = 1$ and $x = -1$. Both roots have a multiplicity of 3.

The above two examples illustrate the process of factoring a polynomial equation. In the first example, we factored the polynomial $(x^2 - 1)(x - 1)$ into $(x - 1)^2(x + 1)$. In the second example, we factored the polynomial $(x^2 - 1)(x - 1)^2(x + 1)^2$ into $(x - 1)^3(x + 1)^3$.

The process of factoring a polynomial equation involves finding the roots of the equation and determining their multiplicities. This can be done by using various techniques, such as the Rational Root Theorem, synthetic division, and the quadratic formula.

The roots of a polynomial equation are the values of x that satisfy the equation. The multiplicity of a root is the number of times that root appears in the factored form of the polynomial.

The above two examples show that the roots of a polynomial equation are the values of x that make the polynomial equal to zero. The multiplicity of a root is the number of times that root appears in the factored form of the polynomial.

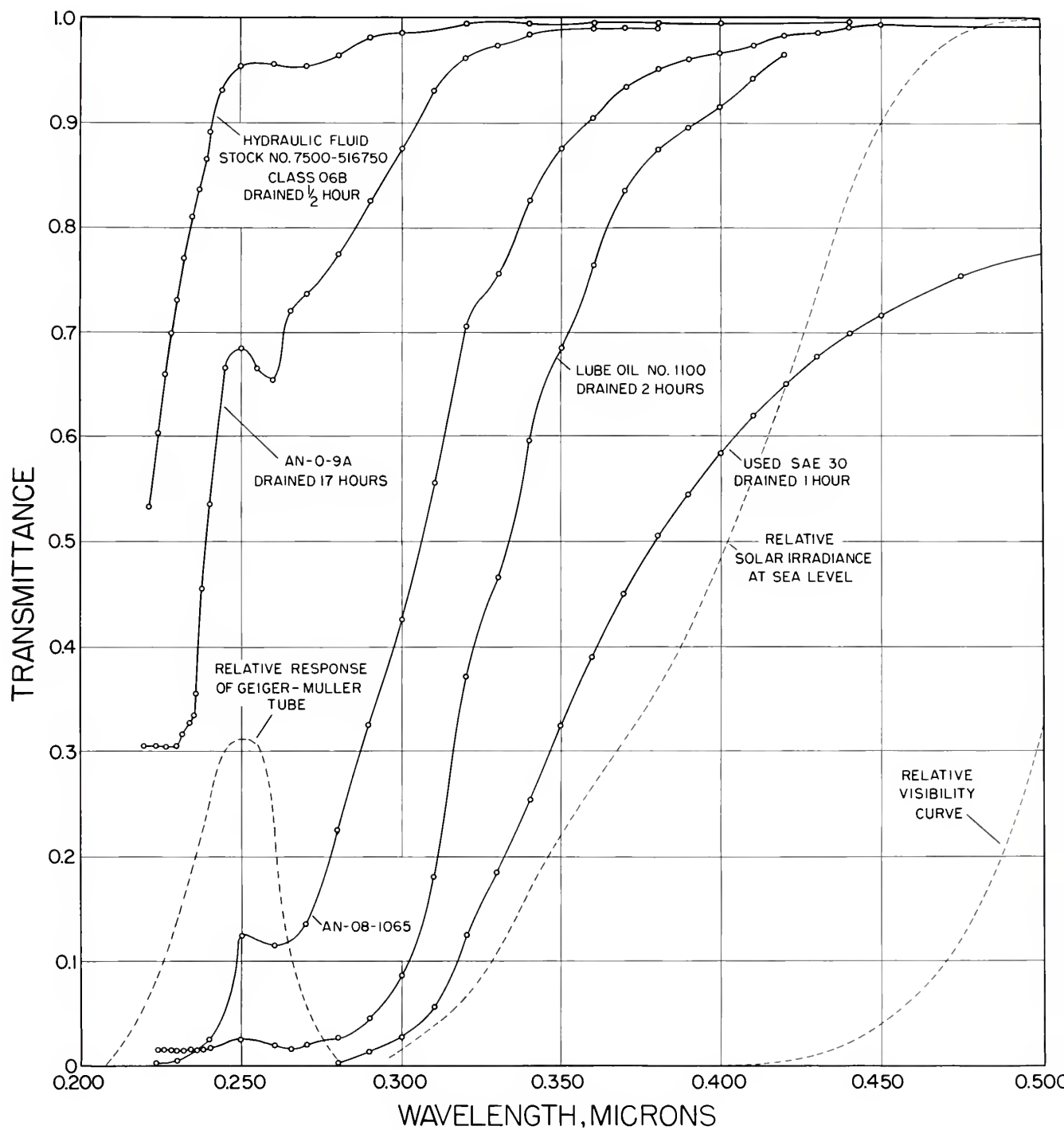

FIG. 26 SPECTRAL TRANSMITTANCE OF OIL FILMS, VISIBILITY, SOLAR IRRADIANCE AND RESPONSE OF GEIGER-MULLER TUBE

surface of a quartz window with the oil and supporting it at room temperature in a vertical plane while the oil drained for periods of time indicated on the curves. The oil films formed with the clean oils were hardly detectable with the unaided eye. Heavier oils and greases transmit less radiant energy in this wavelength region.

The relative response curve of a Geiger-Muller tube of the type described by Weisz [22] is also shown in Fig. 26. It is seen that some of the thin oil films (without any dirt) will absorb practically all the radiant energy below 0.29 micron.

Some experiments were made with a Geiger-Muller tube. When the tube was at atmospheric temperatures, flames as small as those of a lighted match were readily detected in a normally lighted room or in sunlight. However, when the temperature of the particular G-M tube used was raised to 190°F (88°C), it became completely insensitive to radiant energy from flames. Upon cooling to a lower temperature, it regained its sensitivity. No other experiments were made with this type of detector.

Referring to equation (8), $N(0-0.29)$ from the sun at the earth's surface and from heated engine parts is negligible. Although $N(0-0.29)$ from flames is small, it is sufficient to be detected with Geiger-Muller tubes which have an appreciable response $R(0-0.29)$ at atmospheric temperatures. However, at ambient temperatures above 190°F, $R(0-0.29)$ became negligible*. Oil films or soot deposits on the envelope reduces $T(0-0.29)$ to a negligible quantity.

Although the energy emitted by diffusion flames in the wavelength region below 0.29 micron was readily detected by a Geiger-Muller tube, no energy from these flames was detected with the 1P28 photomultiplier and the filter described in Section 3.1.2.2. On the other hand, there was sufficient energy radiated at these wavelengths by premixed flames to be measurable by means of this equipment (see Table 8). Although the optical properties of the filter described in Section 3.1.2.2 have been remarkably stable for about one year under laboratory conditions, no such filter composed of aqueous solutions can be expected to retain its normal properties at temperatures much above 100°C or below 0°C. No suitable

*It is understood that some experimental tubes have operated satisfactorily at much higher temperatures.

... of a ... with ...
... in a ...
... of ...
... of ...
... of ...

... of ...
... of ...
... of ...
... of ...

... of ...
... of ...
... of ...
... of ...
... of ...

... of ...
... of ...
... of ...
... of ...
... of ...

... of ...
... of ...
... of ...
... of ...
... of ...

... of ...
... of ...

solid filters for this region are known to the authors.

Because of these factors, Geiger-Muller tubes are more suitable than filtered photocells for selective response to energy of these wavelengths, but in either case, the low transmittance of oil and soot films in this region prevents direct applications of these devices in engine spaces unless measures are taken to remove such films or prevent their formation.

It may be concluded that no practical method of utilizing the radiant energy from flames in the wavelength region below 0.29 micron for detecting accidental fire in aircraft engine spaces is apparent to the authors.

6.6.1.2 Amount of Radiant Flux from 0.3 to 0.7 Micron

Nearly all flames emit energy in the region of the spectrum from 0.3 to 0.7 micron and there are a number of methods of detecting such energy. However, very thin soot films absorb strongly in this region and, since this region contains a large part of the energy from the sun, the problem of interference from this source must be considered.

The visible spectrum includes most of this region, the response of the normal eye extending from about 0.4 to about 0.7 micron with a maximum at about 0.55 micron. The radiant flux density on a surface evaluated in terms of the response of the eye is known as the illumination and may be expressed in foot candles, one foot candle being the illumination at one foot from a one candlepower source. The maximum illumination just outside the earth's atmosphere due to the sun has been found by calculation to average about 13,600 foot candles. At the earth's surface, the maximum illumination on a clear day is about 10,000 foot candles, about 90 percent of which is due to direct rays from the sun. The remainder, being scattered light from the sky, contains practically no infrared. In contrast to these values, the illumination at one meter from the flames obtained by burning gasoline in the 6 inch burner previously described was 3.8 foot candles in still air, 25 foot candles in a 10 mph wind, and 21 foot candles in a 20 mph wind. Klein [12] found that the maximum illumination at the location of photovoltaic cells within an engine compartment during several fires was 50 to 100 foot candles. This indicates the necessity of considering daylight, both skylight and direct sunlight, as a source of interference in all systems designed to detect radiation in the visible part of the spectrum.

...the ... of ...
...the ... of ...
...the ... of ...

...the ... of ...
...the ... of ...

...the ... of ...

...the ... of ...
...the ... of ...

...the ... of ...
...the ... of ...

...the ... of ...
...the ... of ...

...the ... of ...
...the ... of ...

Most receivers used for the measurement of illumination are of the photosensitive type. The amount of radiant energy in this wavelength interval can be measured readily in the laboratory with thermosensitive receivers. (A thermosensitive receiver is one in which radiant energy is converted into heat that produces a difference in temperature within the receiver. The magnitude of this temperature difference is a measure of the net radiant flux received). However, the amount of radiant flux from flames in this wavelength interval is so small that the devices are too delicate for aircraft applications. Only about 0.05 percent of the total energy radiated by a diffusion flame is in the wavelength region below 0.7 micron and less than this in premixed flames.

6.6.1.3 Amount of Radiant Flux in the Infrared Wavelength Region

Most of the energy radiated by flames is in the infrared portion of the spectrum. The same is true of the energy radiated by heated engine parts, although the amount of radiant flux from each source in each wavelength band is not necessarily the same. Consequently, if a radiation device depending upon the amount of radiant flux received is to be used for the detection of fires, it must be provided with means of distinguishing between the radiant energy from the flames and that from the engine parts. Although the amount of radiant flux from an accidental fire and from the engine parts at the time the fire occurs cannot be controlled, it is possible to control, by the selection of an envelope material and/or filters, the wavelength band of the radiant flux incident upon the receiver and by the selection of a receiver, the response characteristics of the receiver.

Receivers that might be used in the infrared portion of the spectrum may be divided into two general types: Photosensitive and Thermosensitive. Of the general classes of photosensitive detectors, the photovoltaic and photoelectric types are of no special interest for the infrared detection of flames because neither respond to energy of wavelengths greater than 1.2 microns. There are, however, three well known types of photoconductive cells which are sensitive at much longer wavelengths: lead sulfide, lead selenide, and lead telluride cells. The last two may be discounted because they do not have a usable photoconductivity unless cooled to at least -78°C and are generally operated at -190°C in a vacuum. The lead sulfide cell, sensitive from about 0.5 to about 3.0 microns, is operable under normal atmospheric conditions and is

commercially available. The sensitivity depends somewhat on the wavelength within the range given above and upon the ambient temperature. The maximum temperature at which it is claimed to be useful is 400°F.

The response of a thermosensitive radiation receiver depends upon the net transfer of radiant flux from the source to the receiver. If the receiver and the background viewed by it are at the same temperature there can be no net transfer of heat between them and consequently, no response. If, under such conditions, a flame appears between the background and the receiver, it will respond to the radiant flux from the flame. In this case, the flux density at the receiver would be given approximately by equation (7) where $J(\lambda_1 - \lambda_2)$ is the radiance of the flame and Ω is the solid angle subtended by it.

The response of thermosensitive receivers, per unit of net radiant flux received, can be made practically independent of the wavelength of the radiant energy and of the ambient temperature of the receiver. In general, receivers of this type are not sensitive to radiant energy from the clear sky but they are sensitive to direct radiant energy from the sun. The flux density of solar radiant energy at normal incidence on the earth's surface is about 0.13 watt/cm².

During a quick engine warm-up, the temperature of the receiver may lag that of the engine parts to such an extent that the radiant flux from the receiver is negligible compared to that received from the background. In this case, the radiant flux density at the receiver would be given approximately by equation (7) where $J(\lambda_1 - \lambda_2)$ is the radiance of the background and Ω is the solid angle subtended by it. The possibility of such a condition must be assumed, since, in order to be completely dependable, a fire detecting system must detect a fire under the most adverse conditions.

In order to effectively utilize the amount of radiant flux from a flame in a fire detecting system, the minimum amount incident upon the receiver from a flame must always be greater than the maximum amount received from the background. Referring to equation (8), the maximum response for radiant energy from the background would probably occur during a quick warm-up in which heated engine parts completely fill the field of view of the receiver and when the receiver envelope is clean. The minimum response from a fire would occur with a blue flame which only occupied a small part of the field of view of the receiver and with the window partially covered with particles of dirt and/or soot. Although the minimum size of fire that might occur in an aircraft engine

has not been established, it will be assumed, quite arbitrarily, that it will occupy not less than 1/5 the field of view of a receiver. In such a case, the minimum solid angle, Ω , in equation (8) for a flame will be 1/5 that for the background.

Values of the radiance of blackbodies at different temperatures are given in Table 6 and those observed for various flames are given in Tables 1, 2, 3, and 4. Although the engine parts do not radiate as a blackbody, the emissivity of aluminum covered with an oil film is approximately 0.6 [74]. (The emissivity of clean aluminum, cast or wrought, is generally less than 0.1 at any temperature which might be encountered in service). If some dirt particles are added to the oil film, the emissivity will be increased, possibly to as much as 0.8. Consequently, the radiance of heated engine parts will not differ greatly from that of a blackbody at the same temperature.

The transmittance of the receiver envelope will depend to some extent upon the type and amount of foreign material which accumulates on its surface. The transmittance of the envelope in the infrared is not greatly affected by oil films. According to Flyler and Ball [73], the transmittance of a layer of carbon black (that transmitted only 0.1 percent in the visible spectrum) was greater than 70 percent at wavelengths from 10 to 39 microns. However, the transmittance of the same layer of carbon black decreased from about 50 percent at 4 microns to a negligible amount at 0.7 micron. In the present work some measurements were made of the transmittance of radiant energy by soot films deposited on a quartz plate in a natural gas diffusion flame. A film with a transmittance of 1.0 percent in the visible spectrum transmitted 42 percent of the energy radiated by a gasoline diffusion flame and received through a pyrex window. The same film transmitted 50 percent of such radiant energy received through a quartz window. In general, the transmittances of a film of any thickness in these three regions of the spectrum of radiant energy from a gasoline diffusion flame were found to be related as follows:

$$\log T_Q = 0.80 \log T_P = 0.15 \log T_V$$

where T_Q , T_P , and T_V are the transmittances for the energy received through quartz and pyrex, and the visible region, respectively, and the logarithms may be taken to any base.

In the wavelength region 0 to 2.6 microns (the approximate limits established by the transmittance of a pyrex window), the normal radiance observed for premixed flames ranged from 0.02 to 0.15 watt/(cm²-steradian) and that for the diffusion flames from 0.34 to 1.80 watt/(cm²-steradian), compared to 0.0037, 0.072, and

0.30 watt/(cm²-steradian) for blackbodies at 600°, 1000°, and 1300°F, respectively. Thus, if the factors $T(0-2.6)$, $R(0-2.6)$, and S in equation (8) were constant in service and the same for the background in the field of view of the receiver as for a fire, the radiance and consequently the minimum response of the receiver for premixed flames would be approximately 5 times that of a background at 600°F, and for diffusion flames approximately 90 times that of a blackbody at 600°F. However, if the background is raised to 1000°F, these ratios are reduced by a factor of about 20, and if it is raised to 1300°F, they are reduced by a factor of about 80.

According to reference [73], the ratio of the transmittance of a clean pyrex window, in the wavelength interval 0 to 2.6 microns, to that of one with a thick soot deposit might be as great as 8. If the solid angle, S , subtended by the flame at the receiver were only 1/5 the solid angle subtended by the background, the product, $T(0-2.6) S$, could vary by a factor of about 40. Consequently, if the background does not exceed 600°F and if it can be assured that the flame is of the diffusion type and that it will occupy at least 1/5 the field of view, the amount of radiant flux in this wavelength region might be used to distinguish between the radiant energy from a fire and that from the background. Since an accidental fire cannot be depended upon to fulfill all the above requirements, the use of such a system is not recommended.

In the wavelength region 0 to 3.8 microns (the approximate limits established by the transmittance of a fused silica window), the normal radiance observed for premixed flames ranged from 0.06 to 0.47 watt/(cm²-steradian) and that for diffusion flames from 0.48 to 2.78 watts/(cm²-steradian) compared to 0.025, 0.23, and 0.70 watt/(cm²-steradian) for blackbodies at 600°, 1000°, and 1300°F respectively. The minimum radiance for the premixed flames was about 2.4 times that of a background at 600°F and for the diffusion flames approximately 20 times that of a blackbody at 600°F. If the background is raised to 1000°F, these ratios are reduced by a factor of about 10, and if it is raised to 1300°F they are reduced by a factor of about 28.

In this case, the ratio of the transmittance of a clean fused silica window, in the wavelength interval 0 to 3.8 microns, to that of one with a thick soot deposit might be as great as 4. If it is assumed again that the solid angle subtended by a flame is 1/5 of that subtended by the background, the product, $T(0-3.8) S$, might vary by as much as 20. Under the most adverse conditions, then, the maximum amount of radiant flux received from the background at 600°F would be nearly equal to that from a diffusion flame occupying 1/5 the field of view with the receiver envelope dirty.

...the ... of ...
...the ... of ...
...the ... of ...
...the ... of ...
...the ... of ...
...the ... of ...
...the ... of ...
...the ... of ...
...the ... of ...
...the ... of ...

...the ... of ...
...the ... of ...
...the ... of ...
...the ... of ...
...the ... of ...
...the ... of ...
...the ... of ...
...the ... of ...
...the ... of ...
...the ... of ...

...the ... of ...
...the ... of ...
...the ... of ...
...the ... of ...
...the ... of ...
...the ... of ...
...the ... of ...
...the ... of ...
...the ... of ...
...the ... of ...

...the ... of ...
...the ... of ...
...the ... of ...
...the ... of ...
...the ... of ...
...the ... of ...
...the ... of ...
...the ... of ...
...the ... of ...
...the ... of ...

In the wavelength region 0 to 9.5 microns (the approximate limits established by the transmittance of a calcium fluoride window), the normal radiance observed for premixed flames ranged from 0.27 to 1.27 watts/(cm²-steradian), and that for diffusion flames from 0.77 to 3.87 watts/(cm²-steradian), compared to 0.15, 0.66, and 1.48 watts/(cm²-steradian) for blackbodies at 600°, 1000°, and 1300° F, respectively. The minimum radiance for the premixed flames was about 2 times that of a blackbody at 600° F and for the diffusion flames approximately 5 times that of a blackbody at 600° F.

In this case the ratio of the transmittance of a clean calcium fluoride window in the wavelength interval 0 to 9.5 microns, to that of one with a thick soot deposit might be as great as 2. If it is assumed that the solid angle subtended by a flame is 1/5 of that subtended by the background, the product, $T(0-9.5)$, might vary by as much as 10. Under the most adverse conditions, the maximum amount of radiant flux received from the background at 600° F might be nearly 2 times the minimum received from a diffusion flame.

In general, the fraction of the radiant energy from a flame is greater than that of the engine parts in the shorter wavelength regions. However, in these wavelength regions, the uncertainty in the transmittance of the receiver envelope due to soot deposits is also greater. In the longer wavelength regions where the transmittance is not so greatly affected by soot deposits, the fraction of the radiant energy from the engine parts may be greater than that from the flame.

Although it is our belief that an accidental fire in an aircraft engine space will be of the diffusion type with a normal radiance greater than the minimum which we have used in the above discussion, we feel that the uncertainty in the transmittance of the envelope and in the solid angle subtended by the fire is so great that the reliability of a fire detecting system which utilizes the amount of radiant flux incident upon a receiver to actuate an alarm is questionable. The accumulation of soot on the envelope during a fire and the reduction in the size of the fire during extinguishing procedures may result in a false indication of "fire-out". The accumulation of soot on the envelope during a fire may be sufficient to prevent the system from giving an alarm if a second fire occurs.

6.6.2 Ratio of Radiant Intensities in Two Wavelength Intervals

Since the spectral distribution of the radiant energy from a flame is not identical with that of the heated parts or of solar radiant energy, fire detecting systems which depend upon the ratio

...the ... of the ...
...the ... of the ...
...the ... of the ...
...the ... of the ...
...the ... of the ...
...the ... of the ...
...the ... of the ...
...the ... of the ...
...the ... of the ...
...the ... of the ...

...the ... of the ...
...the ... of the ...
...the ... of the ...
...the ... of the ...
...the ... of the ...
...the ... of the ...
...the ... of the ...
...the ... of the ...
...the ... of the ...
...the ... of the ...

...the ... of the ...
...the ... of the ...
...the ... of the ...
...the ... of the ...
...the ... of the ...
...the ... of the ...
...the ... of the ...
...the ... of the ...
...the ... of the ...
...the ... of the ...

...the ... of the ...
...the ... of the ...
...the ... of the ...
...the ... of the ...
...the ... of the ...
...the ... of the ...
...the ... of the ...
...the ... of the ...
...the ... of the ...
...the ... of the ...

...the ... of the ...
...the ... of the ...
...the ... of the ...
...the ... of the ...
...the ... of the ...
...the ... of the ...
...the ... of the ...
...the ... of the ...
...the ... of the ...
...the ... of the ...

of the radiant flux in 2 selected wavelength intervals for their operation have been proposed. Tests of such detecting systems have been made under simulated flight conditions [12,13]. Although the results of tests of early experimental models appeared encouraging, and although the principle appears sound, such systems have not been developed to a stage where they will withstand the conditions encountered in aircraft operations. Some of the difficulties are given below.

The 2 different wavelength intervals may be established by the selection of suitable envelopes and filters, by the selection of 2 receivers with suitable response characteristics, or a combination of these methods. Any change in the ratio of the transmittances of the 2 envelopes or filters will affect the operation of the system, irrespective of the type of receivers employed. Enclosing the receivers and filters in a single envelope will not entirely eliminate the changes in the ratio of the transmittances for 2 different wavelength intervals because of the selective absorption of deposits of foreign materials on the envelope. The transmittance curves of oil films, Fig. 26, and soot deposits [73] are examples.

Any changes in the sensitivity of the receivers as a result of operational conditions, ambient temperature, etc., will affect the operation of the system. The system must be so balanced that it will not operate when exposed to direct radiant energy from the sky or heated engine parts or to reflected radiant energy from selectively reflecting surfaces.

In the present investigation, the approximate ratio of the radiant intensities in wavelength intervals 0.55 to 0.7 and 0.4 to 0.55 micron ranged from less than 0.01 to 0.5 for the premixed flames and from 3 to 220 for the diffusion flames. There is no reason to believe that flames cannot be produced in which the ratios of the average intensities is between 0.5 and 3 for these wavelength intervals. This ratio for daylight is approximately one. Consequently, it is questionable that a system utilizing these two wavelength intervals in the visible spectrum will detect both blue and yellow flames and still not operate when exposed to sunlight. A heavy soot deposit on the envelope would render such a system inoperative.

Since most of the energy radiated by flames is in the infrared portion of the spectrum and since the transmittance of soot films is much higher in the infrared than in the visible portion of the spectrum, the possibilities of utilizing the ratio of the radiant flux in two wavelength intervals in the infrared warrant consideration.

Figures 11, 12, and 15, give the ratios $N(0-2.6)/N(0-9.5)$, $N(0-3.8)/N(0-9.5)$, and $N(0-2.6)/N(0-3.8)$, respectively, observed for different types of flames and for a blackbody at different temperatures. It will be noted that each of these ratios for premixed flames is about the same as that for a blackbody in the temperature range 800° to 1000°F. However, these ratios for diffusion flames are all higher than the corresponding ratios for a blackbody at 1300°F. Consequently, if accidental aircraft fires were always of the diffusion type and if the ratio of the transmittances of the envelopes in the different wavelength intervals were constant, a fire detecting system utilizing any one of these ratios of radiant flux for its operation should be reliable. However, for a soot film such as that referred to in reference 73, $T(0-2.6)/T(0-9.5)$ is equal to about 1/4 and $T(0-3.8)/T(0-9.5)$ and $T(0-2.6)/T(0-3.8)$ are each equal to about 1/2. When these ratios of transmittances are multiplied by the corresponding ratios of radiances for diffusion flames, the product is approximately the same as that for a blackbody in the temperature range 800° to 1000°F without soot on the envelopes. Consequently, if the envelope of the receivers is covered with soot during a fire, the system might indicate a "fire-out" when fire still existed and it might not respond to a second fire.

6.6.3 The Flicker of Flames

The aspect of the radiant energy from flames that has received the most attention in the development of fire detecting systems for aircraft is the flicker. According to reports of tests under simulated flight conditions, 4,5,22 a fire detecting system utilizing a photoconductive cell and frequency selective circuitry will detect fires when they occur in an aircraft engine compartment and will indicate when they are extinguished, as long as the receiver is not made insensitive by overheating. It has been reported that such systems are subject to occasional false alarms under certain conditions but some of these conditions and the methods of prevention of false alarms resulting from them seem to be fairly well known. Except for these limitations, this type of fire detecting system appears to meet most of the requirements of the Air Force.

In the present work, flicker was readily observed in all the hydrocarbon flames studied. The principal flicker maxima of all flames was between 3 and 25 cps. The ratio of flicker (RMS values) to average radiant intensity was greater than 0.2 for all diffusion flames on liquid fuel. In the basis of these observations, it appears that flicker detection is a sound operating principle.

It has been claimed that the tendency to give false indication of fire in rain conditions has been eliminated in some installations by properly locating the receivers. Reports of false alarms on aircraft flying over lighted cities at night have been attributed to unnecessarily high sensitivity, a factor which can be controlled.

There are at least two methods of circumventing the over-heat problem. One now under consideration is to locate the detectors behind the fire-wall in the cooler accessory compartment. Another method which might be considered is the use of thermosensitive radiation receivers that retain their sensitivity at high temperatures. This would also greatly reduce the probability of false alarms due to modulated radiant flux from the sky or other sources outside the engine compartment. However, it would not necessarily eliminate the possibility of false alarms resulting from rain conditions. It would be necessary that such a receiver have a sufficiently small time constant to respond adequately at the required frequencies. It has been reported that thermistor type bolometers with time constants of 3.5 milliseconds have been constructed. This time constant is of the order required for the detection of the flicker of flames.

At the present time, devices utilizing the flicker characteristics of flames are more highly developed than detectors operating on any other radiation characteristic; nonetheless, it is very likely that any device which is sensitive to modulated radiant energy in the very near infrared only will be sensitive to certain amounts of modulated radiant energy from the sky and other sources as well as to that from flames. Only flight tests under actual service conditions will establish the reliability of such systems.

6.6.4 Rate of Change in Radiant Flux

One characteristic of an aircraft fire that appears to warrant consideration as the operating principle of a fire detecting system is the suddenness with which such a fire attains its full radiant intensity. Although the rate of temperature rise of elements contacted by flames has been used in fire detecting systems, as far as we know, the use of the rate of increase in the radiant intensity of flames has not been mentioned in the literature.

Measurements made on diffusion flames of liquid hydrocarbon fuels indicated that they attained their full intensity

in 0.2 to 0.3 second after ignition. Although the normal radiance of engine parts at temperatures in the range 1000° to 1300°F may be approximately the same as that of thin flames, the time required for the engine parts to attain these temperatures is quite long (one minute or more) compared to 0.2 second. If it is assumed that one minute is required for the engine parts to attain their maximum temperature during a quick warm-up, the average rate of increase in the radiance of a flame will be about 300 times that of the engine parts, provided the radiance of each attains the same value.

The average rates of increase in the normal radiance observed for the different types of flames and for a blackbody at different temperatures are given in Table 10. It has been assumed that the full radiance of the flames was attained in 0.2 second and that of the blackbodies in one minute. Since the emissivity of engine parts is less than that of a blackbody, the values of radiance and the rate of increase in it would be less than those of a blackbody at the same temperature.

When a fire starts in an engine space viewed by a receiver, the immediate change in the radiant flux density, in any wavelength interval, $\lambda_1 - \lambda_2$, at the receiver is given by

$$\dot{q} = \omega_f^2 (\lambda_1 - \lambda_2) (\dot{r}_f - a \dot{r}_0) \quad (9)$$

where ω_f is the solid angle subtended by the flame at the receiver, and in the wavelength interval, $\lambda_1 - \lambda_2$, \dot{r}_f ($\lambda_1 - \lambda_2$) is the transmittance of the receiver envelope, \dot{r}_f is the normal radiance of the flame, "a" is the fraction of radiant flux from the background absorbed by the flame, and \dot{r}_0 is the normal radiance of the background. The value of "a" is about 0.1 for thin diffusion flames and much less than that for premixed flames. The value of "a" may increase considerably for thick diffusion flames, but when it does ω_f increases in about the same proportion. For the wavelength interval 0 to 2.5 microns, the value of "a \dot{r}_0 " for a blackbody background at 1300°F is about 0.2 of the minimum value of \dot{r}_f and for a blackbody background at 1000°F, about 0.1 of the minimum value of \dot{r}_f . The corresponding values for the other wavelength intervals given in Table 10 are less.

Equation (9) does not depend upon the net transfer of radiant flux between the background and the receiver. If the fire breaks out when the background and receiver are at the same temperature, then \dot{q} is the only net flux at the receiver. If

Table 10

Average Rate of Increase in Normal Radiance
of
Flames and Blackbodies

Wavelength Interval Microns	Source of Radiant Energy	Normal Radiance watt/(cm ² -steradian)	Average Rate ¹ of Increase in Radiance Watt/(cm ² -ster-sec)
0-2.6	Premixed Flames	0.02-0.15	0.1-0.75
	Diffusion Flames	0.34-1.80	1.7-9.
	BB at 600°F	0.0037	0.00006
	BB at 1000°F	0.072	0.0012
	BB at 1300°F	0.30	0.005
0-3.8	Premixed Flames	0.06-0.47	0.3-2.4
	Diffusion Flames	0.48-2.78	2.4-14.
	BB at 600°F	0.025	0.0004
	BB at 1000°F	0.23	0.004
	BB at 1300°F	0.70	0.012
0-9.5	Premixed Flames	0.27-1.27	1.3-6.3
	Diffusion Flames	0.77-3.87	3.8-19.
	BB at 600°F	0.15	0.0025
	BB at 1000°F	0.66	0.011
	BB at 1300°F	1.48	0.025

¹Based upon the radiance of flames attaining the values in Column 3 in 0.2 sec and that of the blackbodies attaining the values in Column 3 in one minute.

the fire breaks out at the end of a quick warm-up when the engine parts are hot and the receiver still relatively cold, then \dot{W} is superimposed upon the radiant flux density from the background.

If $\dot{W}_e = \dot{W}(\lambda_1 - \lambda_2)$, and " \dot{W}_e " in equation (9) are considered constant during the fraction of a second in which \dot{W}_e attains its maximum value, the average rate of increase in \dot{W} with time can be computed from the average rate of increase in \dot{W}_e . In the same way, the rate of increase in \dot{W} from the background is proportional to the rate of increase in \dot{W}_e , if the solid angle and the transmittance are constant (see equation 7).

In Section 4.6.1.3, it was assumed that, in the wavelength interval 0 to 3.6 microns, $\dot{W}(0-3.6)$ might vary by as much as 40. In the most adverse case then, the lowest rate of increase in \dot{W} obtained for premixed flames would be about twice the maximum from the background at 1000°F. The lowest rate of increase in \dot{W} obtained for a diffusion flame would be about 0.5 times the maximum from the background at 1300°F.

In the wavelength region 0 to 3.8 microns, it was assumed that $\dot{W}(0-3.8)$ might vary by as much as 20. In this case, the lowest rate of increase in \dot{W} obtained for a premixed flame would be about 1.25 times, and that obtained for a diffusion flame about 10 times the maximum from the background at 1300°F.

In the wavelength region 0 to 9.5 microns, it was assumed that $\dot{W}(0-9.5)$ might vary by as much as 10. In this case, the lowest rate of increase in \dot{W} obtained for a premixed flame would be about 5 times and that obtained for a diffusion flame about 15 times the maximum from the background at 1300°F.

A flash of flame in the nacelle without any ensuing fire would result in a false alarm if the fire detecting system depended only on the rate of increase in the radiant flux to indicate fire. Although the rate of increase in the radiant flux appears to be a characteristic of a flame that might be utilized to advantage in conjunction with other characteristics in the detection of fires, the rate of decrease in the radiant flux during extinguishment would not provide a reliable indication of "fire-out", because of the uncertainty in the time required to extinguish the fire. The main body of a fire may be subdued in a very short time thereby giving a very rapid decrease in the radiant flux, but there is still the possibility that small residual fires may persist and cause a flash back. Such a condition might result in a false indication of fire-out. The intensity of a fire might be slowly reduced to complete extinguishment without any rapid decrease in the radiant flux.

6.6.5 The Rate of Increase in Radiant Flux and the Flicker

If a fire is to be detected as early as possible, the detecting system should initiate its cycle of operation at the instant of ignition. Figure 23 shows an oscillographic record of the radiant intensity of a fire from the instant of ignition. Two significant features of this record are (a) the rapid rate of increase in the intensity during the first 1/4 second after ignition, and (b) the flicker that follows. It is believed that this combination of characteristics is peculiar to a fire and that it would not be duplicated by radiant energy from the engine parts.

Rain in the engine space might modulate background radiant flux at the receiver, simulating the flicker of a flame, but if so, this phenomenon would accompany a decrease in radiant flux rather than an increase.

A sudden break in the skin of the engine compartment might produce a rapid increase in the radiant energy from the sky. If, by chance, this energy were modulated by some means or if the aircraft were exposed to gunfire, simulated flicker could follow. Most of the radiant energy from the sky would be in the visible and near infrared parts of the spectrum and the amount of radiant flux from the sky incident upon a receiver viewing an engine space would be far less than that from a flame within the engine space. Since flames emit considerable amounts of energy farther in the infrared, it should be possible to discriminate between these circumstances and the outbreak of fire by selecting receivers with the proper spectral response. A thermosensitive receiver could have sufficient sensitivity in the infrared to detect a fire in an engine compartment and still not be appreciably effected by radiant energy from the sky or from gunfire. Such a receiver would probably be appreciably effected if sighted directly at the sun or a nearby shellburst. However, since the receiver would normally be sighted at an engine part, it would not be sighted directly at these other sources unless the engine part were missing.

If both the initial rate of increase in the radiant flux and the flicker for several cycles are required to give an alarm, a flash of flame in the nacelle without any ensuing fire would not result in an alarm because of the absence of the several cycles of flicker.

By combining in a fire detecting system the initial rate of increase in radiant flux with the flicker it should be possible to eliminate readily many of the possible causes of false alarms in the flicker type fire detecting system.

According to reports, written and verbal, the existing flicker fire detecting system has been reliable in indicating "fire-out", provided the photoconductive cell was not overheated. If, in the absence of a suitable thermosensitive receiver, a photoconductive cell is used to detect flicker, it should be so located that it will not be overheated.

The fire detecting system envisioned here would require two interlocking circuits; one which is actuated by the initial rate of increase in the radiant energy and the other by the flicker. The circuits could be arranged to give a warning signal in case only one was actuated.

...the ... of ...
...the ... of ...
...the ... of ...
...the ... of ...
...the ... of ...

...the ... of ...
...the ... of ...
...the ... of ...
...the ... of ...
...the ... of ...

SECTION VII

SUMMARY

It has been demonstrated in fire tests under simulated flight conditions that fire detecting systems which depend upon a flame contacting a sensing element for their operation may be used advantageously in certain locations on aircraft. However, in large compartments, where the fire may not completely fill the space and the flame paths are uncertain, there is always a possibility that the flame may not contact the sensing element sufficiently to register an alarm. Another disadvantage of systems of this type is that, in order to be reasonably effective, the sensing elements must be located in the fire zone and separated from the surfaces from which they are supported. In such locations, the elements interfere with normal maintenance operations and are subject to damage during such operations, in addition to being exposed to the full intensity of a fire. A further disadvantage of such systems is that each new type of nacelle must be tested to determine the most probable flame paths and the most effective locations of the sensing elements.

It has also been demonstrated that fire detecting systems which utilize the radiant energy from flames for their operation have certain distinct advantages and avoid the disadvantages enumerated above. However, fire detecting systems of this type have some disadvantages of their own. A study of the characteristics of flames that might be utilized in fire detecting systems and an evaluation of the various systems with due consideration of the requirements of the Air Force revealed that fire detecting systems which utilized only one characteristic of a flame were lacking in some respect. Consequently, in order to circumvent such deficiencies, it is recommended that two characteristics of a flame, the initial increase in the radiant intensity of a flame and the flicker of the flame that follows, be utilized in a fire detecting system for Air Force aircraft.

In order to utilize these two flame characteristics in a fire detecting system suitable for Air Force operations, the radiant energy receivers must withstand ambient temperatures up to 800° F (and possibly eventually 1000° F) and still have sufficient sensitivity when a fire occurs. The time constant of the receiver which responds to the flicker of the flame should be of the order of 0.005 second, and, although this is less than that required of a receiver to respond to the rate of increase

in the radiant flux, it would be extremely satisfactory if the same receiver is used for both characteristics. If, for any reason, a separate receiver is used for detecting the rate of increase in the radiant flux, it should have a time constant of the order of 0.1 second. It is our opinion that it is very feasible to develop a thermoelectric receiver with these characteristics, better than any other type of radiation receiver with which we are familiar.

In any method utilizing the radiant energy from flames to indicate fire and the changes of such energy to indicate "fire-out", the changes in the transmittance of the receiver envelope, particularly during a fire, must be taken into consideration. It is almost a certainty that soot will collect on the envelope during a fire. The transmittance of a soot deposit for radiant energy in the longer wavelength portion of the spectrum is greater than that for energy in the shorter wavelength portion. Soot and other deposits which are practically opaque in the ultraviolet and visible portions of the spectrum, transmit an appreciable fraction of the incident energy in the infrared. However, as the soot deposit becomes thicker, the fraction of the energy transmitted even in the infrared becomes less.

In the selection of a wavelength interval, consideration must be given not only to the amount of flux radiated by a flame and the transmittance of the envelope (with deposits of foreign materials thereon) but also to the amount of radiant flux from the background in the selected wavelength interval. The greater the wavelength at which the envelope material "cut-off" the greater will be the amount of radiant flux from a flame and the greater will be the transmittance of soot deposits. However, the amount of radiant flux from the background in the same wavelength interval will also be greater. About 10 percent of the radiant energy from the diffusion flames investigated was within the wavelength interval $\lambda \pm 4$ microns. A sensitive material with a long wavelength "cut-off" of 4 microns would transmit about 43 percent of the radiant flux from a candle at 1500° F and less for sizes smaller or lower temperatures.

Any receiver envelope or filter used must withstand ambient temperatures of 500° F (and possibly eventually 1000° F) in addition to the thermal shock and further heating resulting from a fire. The envelope material, therefore, must have characteristics very similar to those of fused silica in so far as resistance to high temperatures and thermal shock is concerned. In order to transmit as much as 75 percent of the radiant flux from a flame, it must have a long wavelength "cut-off" not less than

The first paragraph discusses the general situation of the country and the state of the economy. It mentions the impact of the war and the need for reconstruction. The text is somewhat blurry but appears to be a formal report or document.

The second paragraph continues the discussion, focusing on the specific challenges faced by the government and the population. It mentions the need for international aid and the role of the United Nations. The text is dense and contains many details.

The third paragraph provides a detailed account of the economic situation and the measures being taken to address it. It mentions the role of the private sector and the government's policies. The text is very detailed and covers a wide range of topics.

The fourth paragraph concludes the document, summarizing the main points and expressing the author's hopes for the future. It mentions the need for continued international support and the role of the United Nations. The text is shorter than the previous paragraphs.

that of fused silica, about 4 microns. If thermosensitive receivers are used there would be no need of providing a short wavelength "cut-off".

As a result of studies of reports regarding fire detecting systems and of discussions with personnel associated with the development, manufacture, maintenance, and use of fire detecting systems, we are left with the impression that most difficulties involving malfunction of some systems arise not from the inherent characteristics of the detectors but from those of the associated circuit elements and wiring.

... ..
... ..
... ..

... ..
... ..
... ..
... ..
... ..
... ..

SECTION VIII

RECOMMENDATIONS

It is recommended that a fire detecting system be developed with the following basic requirements.

The fire detecting system shall require the following two characteristics of a flame for the indication of a fire; one, the initial increase in the radiant flux at a radiation receiver viewing the interior of the nacelle, and the other, the flicker of the flame that follows the initial increase. The circuits shall be so interlocked that an indication of fire is given only when both of the above characteristics occur in the proper sequence. The circuits shall also be arranged to give a warning signal when only one of the circuits is actuated.

The system shall give an indication of a fire within 2 seconds of its initial appearance.

The fire detecting system shall clear the fire signal and return to an operational condition within 3 seconds after the fire is completely extinguished.

Suitable provisions for checking the operation of the complete system shall be provided. This check shall be a positive one.

The fire detecting system shall not give false indications of fire under any circumstance, including exposure of receivers to radiant energy from engine parts at temperatures ranging from -65° to $+1300^{\circ}$ F or from the sky.

The fire detecting system shall perform satisfactorily when the radiation receivers are exposed to ambient temperatures in the range -65° to 800° F.

The fire detection system shall operate on 17 to 29 volts DC or 100 to 130 volts and 380 to 420 cps AC, or both.

The fire detecting system shall detect a fire as small as that produced by burning gasoline in an open container 15 cm in diameter, at a distance of 125 cm from the receiver and at any location such that all the flame is within an angle of 45° with the normal to the receiver.

CONFIDENTIAL

It is recommended that a type specimen system be developed
and the following items be included:

The type specimen system shall contain the following:
1. A list of all the specimens to be included in the system.
2. A list of all the specimens to be included in the system.
3. A list of all the specimens to be included in the system.
4. A list of all the specimens to be included in the system.
5. A list of all the specimens to be included in the system.

The system shall be maintained in a secure manner
and the following items be included:

The system shall be maintained in a secure manner
and the following items be included:

The system shall be maintained in a secure manner
and the following items be included:

The system shall be maintained in a secure manner
and the following items be included:

The system shall be maintained in a secure manner
and the following items be included:

The system shall be maintained in a secure manner
and the following items be included:

The system shall be maintained in a secure manner
and the following items be included:

It is further recommended that, in the development of a fire detecting system to comply with the above requirements, consideration be given to the use of the following:

1. Thermosensitive receivers of the thermoelectric and the bolometer type.
2. A receiver envelope material with the thermal and optical properties of fused silica.
3. Magnetic amplifiers in lieu of vacuum tube amplifiers.
4. Circuit components with the minimum of weight and volume.
5. Simplicity in operation and maintenance.

A 30 page report was prepared by the ...
...
...

...
...

...
...

...
...

...
...

SECTION IX

BIBLIOGRAPHY

1. Dallas, A. W. and Hansberry, H. L., Determination of Means to Safeguard Aircraft from Powerplant Failures in Flight. CAA Technical Development Report No. 33 Part I, Sept. 1943
2. Figman, G. L., Determination of Means to Safeguard Aircraft from Powerplant Failures in Flight. CAA Technical Development Report No. 37 Part II, Oct. 1943
3. Hansberry, H. L., Determination of Means to Safeguard Aircraft from Powerplant Failures in Flight. CAA Technical Development Report No. 38 Part III, April 1944
4. Tarbell, L. E. and Keeler, H. R., Determination of Means to Safeguard Aircraft from Powerplant Failures in Flight. CAA Technical Development Report No. 107 Part IV, April 1950
5. Tarbell, L. E., Determination of Means to Safeguard Aircraft from Powerplant Failures in Flight. CAA Technical Development Report No. 198 Part V, April 1953
6. Moore, D. H. Jr., Aircraft Fire Protection. Aero Digest 56, 70 (April 1948)
7. Anon. Continuous Fire Detection. Aero Digest 64, 28 (April 1950)
8. Wheeler, D. R., Fire Detecting Cable. U. S. Patent 2423537
9. Blair, G. L., Fire Detecting Switch. U. S. Patent 2522248
10. Crosby, Fiske, and Forster, W. F. P. A. Handbook of Fire Protection. W. F. P. A. International, Boston, Mass.
11. Denne, R. A., The Problem of Fire in Aircraft. Aircraft Engineering 4, 98 (April 1932)
12. Klein, H. A., Jet Engine Fire Protection Program. A. F. Technical Report No. 5870, Air Materiel Command, Wright-Patterson Field, Ohio. (Feb. 1950)

INDEX

CONTENTS

1. Introduction 1

2. Theoretical Foundations 2

3. Experimental Methods 3

4. Results and Discussion 4

5. Conclusions 5

6. Acknowledgments 6

7. References 7

8. Appendix A 8

9. Appendix B 9

10. Appendix C 10

11. Appendix D 11

12. Appendix E 12

13. Appendix F 13

14. Appendix G 14

15. Appendix H 15

16. Appendix I 16

17. Appendix J 17

18. Appendix K 18

19. Appendix L 19

20. Appendix M 20

21. Appendix N 21

22. Appendix O 22

23. Appendix P 23

24. Appendix Q 24

25. Appendix R 25

26. Appendix S 26

27. Appendix T 27

28. Appendix U 28

29. Appendix V 29

30. Appendix W 30

31. Appendix X 31

32. Appendix Y 32

33. Appendix Z 33

13. C-O-Two Fire Equipment Co., Aircraft Power Plant Fire Protection. Army Air Force Contract No. W-33-038-ac-8489, (Feb 1948)
14. Constantino, J. D., Fire Alarm System
U. S. Patent 2583964
15. Anon., Kidde's Electronic Fire Detector. Aviation Week, 54, 50, (May 14, 1951)
16. Peters, M. F., Fire Detector Element
U. S. Patent 2586252
17. Anon., British Exhibits at Paris, Graviner Mfg. Co., The Aeroplane, 30, 717 (June 15, 1951)
18. Heath, W. Jr., Temperature Responsive Detector System., U. S. Patent No. 2615973
19. Anon., News of Industry. A Developed Fire Detector System. The Aeroplane, 396, Nov. 2, 1951
20. Selby-Mele, R. H., The Fire Danger in Aircraft. Aircraft Engineering 22, 2, (May 8, 1950)
21. Anon., Fighting Engine Fire. Aero Digest 54, 50 (June 1947)
22. Weiss, P. B., Electronic Fire and Flame Detector. Electronics, 19, 106, (July 1946)
23. Davillier, A., Flame Responsive Alarm System. U. S. Patent No. 2024100.
24. Wedel, J. J., Flame Detector. Memorandum No. 4-32. Jet Propulsion Laboratory. California Institute of Technology. June 1948
25. Hansberry, H. L., How You Can Cut Aircraft Fire Danger. Aviation Week, 52, 21, (May 8, 1950)
26. Anon., USAF Buying New Fire Detector
Aviation Week 53, 17, (July 10, 1950)

- 1. ...
- 2. ...
- 3. ...
- 4. ...
- 5. ...
- 6. ...
- 7. ...
- 8. ...
- 9. ...
- 10. ...
- 11. ...
- 12. ...
- 13. ...
- 14. ...
- 15. ...
- 16. ...
- 17. ...
- 18. ...
- 19. ...
- 20. ...

27. Balkind, A., Tests of a Photoelectric Fire Detection System. Memorandum Report No. MCHREB-664-451-L Air Materiel Command, Wright-Patterson Air Force Base, Dayton, Ohio (Feb 23, 1951)
28. Koulichkov, S. N., Fire Detecting Apparatus. U. S. Patent No. 2177493
29. Evans, F. C., Fire Detecting System. U. S. Patent No. 2385976
30. Dahline, J. J., Fire Detecting Apparatus. U. S. Patent No. 2478373
31. Bean, V. O., Fire Detecting Apparatus. U. S. Patent 2455351
32. Anon., Fire and Burglar Alarms. Mechanical Engineering 63, 600, (August 1941)
33. Anon., An Electronic Fire Alarm. The Aeroplane, 72,228 (August 22, 1947)
34. Centlin, J. H., Smoke-Spotting "Eyes" Give Plant Fire Alert. Aviation, 46, 44 (April 1947)
35. Kempner, B., Ultrasonic System Detects Intruders. Electronics, 24, 104, (April 1952)
36. Cleveland Laboratory Aircraft Fire Research Panel, Preliminary Survey of the Aircraft Fire Problems. NACA Research Memorandum RM No. 88B18 (May 22, 1948)
37. Hamer, W. J. and Schrodt, J.P., Investigations of Galvanic Cells with Solid and Molten Electrolytes. Journal of the American Chemical Society 71, 2347 (1949)
38. Weisz, P. B., Automatic Fire Alarm. U. S. Patent No. 2507359
39. Gaydon, A. G., Spectroscopy and Combustion Theory. Chapman and Hall Ltd., London, 1942 pp. 34, 69, 155-176
40. Gaydon, A. G. and Wolfhard, H. G., Flames. Chapman and Hall Ltd., London, 1953

41. Plyler, E. K., Infrared Radiation From a Bunsen Flame. Research Paper RP 1860 Journal of Research of the National Bureau of Standards, 40, 113 (1948)
42. Crowthers, J. A., Ions, Electrons, and Ionizing Radiation. Longmans, Green and Co., London, 1924 Page 130
43. Ellis, O. C. D. and Kirkby, W. A., Flames. Methuen and Co., London, 1936
44. Herzberg, G., Molecular Spectra and Molecular Structure. Prentice-Hall Inc., New York, 1939
45. Lewis, B. (Editor), Third Symposium on Combustion Flame and Explosion Phenomena. Williams and Wilkins Co., Baltimore, 1949 pp 245, 498-530, 641-680
46. Lewis, B. and Von Elbe, G., Combustion, Flames and Explosions of Gases. Academic Press Inc., New York, 1951
47. Pearce, R. W. B. and Gaydon, A. G., The Identification of Molecular Spectra. John Wiley and Sons, New York, 1941
48. Sawyer, R. A., Experimental Spectroscopy. Prentice-Hall Inc., New York, 1944
49. Anon., Aircraft Fire Fighting Equipment. Engineering 148, 236 (August 25, 1951)
50. Anon., New Edison Installation for Capital. Aviation Week, 51, 35 (Nov. 28, 1949)
51. Anon., Fire Protection for Aircraft Powerplants. Aero Digest 44, 86, (Feb. 1944)
52. Anon., Delayed Action Switch for Aircraft Engine Fire Extinguishers. Electrical Review, 146, 85, (Jan. 13, 1950)
53. Glendinning, W. G. and Drinkwater, J. W., Fire Prevention in Aircraft. Shell Aviation News, 122, 19 (August 1948)
54. Hartley, Dr. H., Report on the Conversion of the Potential Energy of Coal Gas into Radiant Energy. Transactions of the Institute of Gas Engineers 62, 466 (1932-33)

- 1. [Illegible text]
- 2. [Illegible text]
- 3. [Illegible text]
- 4. [Illegible text]
- 5. [Illegible text]
- 6. [Illegible text]
- 7. [Illegible text]
- 8. [Illegible text]
- 9. [Illegible text]
- 10. [Illegible text]
- 11. [Illegible text]
- 12. [Illegible text]
- 13. [Illegible text]
- 14. [Illegible text]
- 15. [Illegible text]
- 16. [Illegible text]
- 17. [Illegible text]
- 18. [Illegible text]
- 19. [Illegible text]
- 20. [Illegible text]
- 21. [Illegible text]
- 22. [Illegible text]
- 23. [Illegible text]
- 24. [Illegible text]
- 25. [Illegible text]
- 26. [Illegible text]
- 27. [Illegible text]
- 28. [Illegible text]
- 29. [Illegible text]
- 30. [Illegible text]
- 31. [Illegible text]
- 32. [Illegible text]
- 33. [Illegible text]
- 34. [Illegible text]
- 35. [Illegible text]
- 36. [Illegible text]
- 37. [Illegible text]
- 38. [Illegible text]
- 39. [Illegible text]
- 40. [Illegible text]
- 41. [Illegible text]
- 42. [Illegible text]
- 43. [Illegible text]
- 44. [Illegible text]
- 45. [Illegible text]
- 46. [Illegible text]
- 47. [Illegible text]
- 48. [Illegible text]
- 49. [Illegible text]
- 50. [Illegible text]

85. Harbeck, G. A. and Lerman, R. C., Experimental Flame Spectra. Industrial and Engineering Chemistry 43, 2733 (1951)
86. Sims, W. A. and Townsend, D. W. A., Flame and Combustion in Cases. Langport, Green and Co., London 1921 Page 433
87. Anon., Tentative Recommendations for Fire Protection of Passengers, Baggage and Passengers' Concessions, AIR CARRIER AIRCRAFT. NACA Bulletin No. 17
88. Anon., Aircraft Fire Protection Handbook. NAVAIR 00-102-01, Bureau of Aeronautics, Navy Department, November 9, 1941 (Restricted)
89. Equipment Laboratory, Engineering Division, Aircraft Wing Fire Extinguishing Tests 3-17 Airplane. AAF Technical Report 3105, Air Technical Service Command, Wright Field, Dayton, Ohio (1945) (Declassified)
90. McLeod, M. K., Inflammability Range of Various Aircraft Engine Fuels. Memorandum Report Serial No. WSO-7-311-40, Engineering Division, Air Material Command, Army Air Force, Wright Field, Dayton, Ohio (May 21, 1943)
91. Anon., Jet Engine Fire Protection Study. Engineering Division, Air Material Command, Army Air Force, Wright Field, Dayton, Ohio (July 1947)
92. Boardley, Capt. G. F., Report on Japanese Naval Aircraft Dog System Design. Air Technical Intelligence Review, Headquarters Air Material Command, Wright Field, Dayton, Ohio (August 1946)
93. Suttle, J. H., Coordination Report on Fire Tests on B-29 Model at Wright Field and Indianapolis. Document No. D-3306, Boeing Aircraft Co., Seattle, Washington (June 9, 1947)
94. Klein, R. A., Engine Fire Extinguishing Tests 3-17 Airplane, Memorandum Report Serial No. WSO-404-404, Engineering Division, Air Material Command, Army Air Force, Wright Field, Dayton, Ohio
95. Knickerbocker, H. L., Design Recommendations for Fire Protection of Aircraft Powerplant Installations. Air Technical Development Note No. 11, U. S. Dept. of Commerce, Washington, D. C.
96. Neill, W. H., Relation Between Inflammability and Ignition Sources in Aircraft Environments. NACA Report No. 1023, National Advisory Committee for Aeronautics, Washington, D. C. (1951)

Faint, illegible text, possibly bleed-through from the reverse side of the page. The text is arranged in approximately 10 horizontal lines.

67. Kuhn F., Examination and Testing of Fire Alarm and Fire Extinguishing Devices for Use in Aircraft (Second Partial Report) AAF Translation, Report No. F-TR-775-RE, Air Materiel Command, Wright Field, Dayton, Ohio (1946)
68. Lenard, P., Ueber die Elektrizitätsleitung in Flammen, Ann. der Physik (4) 9, 642 (1902) (in German)
69. Wilson, H. A., The Electrical Conductivity of Flames. Phil. Mag. (6) 10, 476, (1905)
70. Wilson, H. A., Electrical Conductivity of Flames. Rev. of Mod. Phys. 3, 156 (1931)
71. Andrade, E. N. da C., Ueber eine neue Methode, die Flammengeschwindigkeit zu bestimmen. Ann. der Physik (4) 37, 380 (1912) (in German)
72. Andrade, E. N. da C., Some Experiments on the Electrical Behaviour of Metallic Vapours in Flames. Phil. Mag. (6) 24, 15 (1912)
73. Plyler, E. K. and Ball, J. J., Infra-Red Absorption of Deposited Blacks. J. Opt. Soc. Am. 38, 983 (1948)
74. McAdams, W. H., Heat Transmission. McGraw-Hill Book Co., New York, 1942
75. Dahl, A. I. and Flock, E. F., Response Characteristics of Temperature sensing Elements for Use in the Control of Jet Engines. J. Research N. B. S. 45, 292 (1950) R. P. 2136
76. U. S. A. F. Specification No. 45001, 11 May 1949, Detector; Fire, thermocouple, Rate of temperature Rise, Probe Style, Type F-2.
77. Military Specification MIL-F-5369 (USAF), 8 May 1950, Fire Detector, Thermocouple, Type F-1.
78. Military Specification MIL-D-6698 (USAF), Nov. 1, 1951, Detector, Overheat, Adjustable, Type E-4
79. Military Specification MIL-F-6411 (USAF) 16 March 1951, Fire Detector, Thermocouple, Type B-3.

... ..
... ..
... ..

... ..
... ..

... ..
... ..

... ..
... ..

... ..
... ..

... ..
... ..

... ..
... ..

... ..
... ..

... ..
... ..

... ..
... ..

... ..
... ..

... ..
... ..

... ..
... ..

Specifications for a Fire Detecting System
based upon Recommendations in WADC TR 54-307

In our opinion a fire detecting system operating on the principle recommended in the report on "Principles of Fire Detection in Aircraft Engine Spaces" can be developed with any one of several combinations of circuit components. Consequently, in order not to restrict the developer in the use of any circuit component or combinations of such, we are giving here only the basic requirements of the recommended fire detecting system.

The fire detecting system shall require the following two characteristics of a flame for the indication of a fire; one, the initial increase in the radiant flux at a radiation receiver viewing the interior of the nacelle, and the other, the flicker of the flame that follows the initial increase. The circuits shall be so interlocked that an indication of fire is given only when both of the above characteristics occur in the proper sequence. The circuits shall also be arranged to give a warning signal when only one of the circuits is actuated.

The system shall give an indication of a fire within 2 seconds of its initial appearance.

The fire detecting system shall clear the fire signal and return to an operational condition within 3 seconds after the fire is completely extinguished.

Suitable provisions for checking the operation of the complete system shall be provided. This check shall be a positive one.

The fire detecting system shall not give false indications of fire under any circumstances, including exposure of the receivers to radiant energy from engine parts at temperatures ranging from -65° to $+1300^{\circ}\text{F}$ or from the sky.

The fire detecting system shall perform satisfactorily when the radiation receivers are exposed to ambient temperatures in the range -65° to 800°F .

The fire detection system shall operate on 17 to 29 volts DC or 150 to 130 volts and 350 to 420 cps AC, or both.

THE UNIVERSITY OF CHICAGO
DEPARTMENT OF CHEMISTRY

The following is a list of the
members of the Department of
Chemistry, University of Chicago,
for the year 1954-55. The
names are listed in alphabetical
order of last name.

Prof. J. H. Drenth
Prof. R. M. Waymouth
Prof. R. B. Nielsen
Prof. R. G. W. Norrish
Prof. R. S. Stein
Prof. R. H. Drenth
Prof. R. M. Waymouth
Prof. R. B. Nielsen
Prof. R. G. W. Norrish
Prof. R. S. Stein
Prof. R. H. Drenth
Prof. R. M. Waymouth
Prof. R. B. Nielsen
Prof. R. G. W. Norrish
Prof. R. S. Stein

The names of the members of the
Department of Chemistry, University
of Chicago, for the year 1954-55
are listed below.

The names of the members of the
Department of Chemistry, University
of Chicago, for the year 1954-55
are listed below.

The names of the members of the
Department of Chemistry, University
of Chicago, for the year 1954-55
are listed below.

The names of the members of the
Department of Chemistry, University
of Chicago, for the year 1954-55
are listed below.

The names of the members of the
Department of Chemistry, University
of Chicago, for the year 1954-55
are listed below.

The names of the members of the
Department of Chemistry, University
of Chicago, for the year 1954-55
are listed below.

Specifications Continued

The fire detecting system shall detect a fire as small as that produced by burning gasoline in an open container 15 cm in diameter, at a distance of 125 cm from the receiver and at any location such that all the flame is within an angle of 45° with the normal to the receiver

The following information is provided for your information. It is not intended to constitute an offer of insurance or any other financial product. Please contact your agent for more information.

1

THE NATIONAL BUREAU OF STANDARDS

Functions and Activities

The functions of the National Bureau of Standards are set forth in the Act of Congress, March 3, 1901, as amended by Congress in Public Law 619, 1950. These include the development and maintenance of the national standards of measurement and the provision of means and methods for making measurements consistent with these standards; the determination of physical constants and properties of materials; the development of methods and instruments for testing materials, devices, and structures; advisory services to Government Agencies on scientific and technical problems; invention and development of devices to serve special needs of the Government; and the development of standard practices, codes, and specifications. The work includes basic and applied research, development, engineering, instrumentation, testing, evaluation, calibration services, and various consultation and information services. A major portion of the Bureau's work is performed for other Government Agencies, particularly the Department of Defense and the Atomic Energy Commission. The scope of activities is suggested by the listing of divisions and sections on the inside of the front cover.

Reports and Publications

The results of the Bureau's work take the form of either actual equipment and devices or published papers and reports. Reports are issued to the sponsoring agency of a particular project or program. Published papers appear either in the Bureau's own series of publications or in the journals of professional and scientific societies. The Bureau itself publishes three monthly periodicals, available from the Government Printing Office: The Journal of Research, which presents complete papers reporting technical investigations; the Technical News Bulletin, which presents summary and preliminary reports on work in progress; and Basic Radio Propagation Predictions, which provides data for determining the best frequencies to use for radio communications throughout the world. There are also five series of nonperiodical publications: The Applied Mathematics Series, Circulars, Handbooks, Building Materials and Structures Reports, and Miscellaneous Publications.

Information on the Bureau's publications can be found in NBS Circular 460, Publications of the National Bureau of Standards (\$1.25) and its Supplement (\$0.75), available from the Superintendent of Documents, Government Printing Office. Inquiries regarding the Bureau's reports and publications should be addressed to the Office of Scientific Publications, National Bureau of Standards, Washington 25, D. C.

