

NATIONAL BUREAU OF STANDARDS REPORT

2807

MECHANICAL TYPE DOOR INTERLOCK

by

Alfred B. Castle

to

Engineering Division, Military Construction
Corps of Engineers
Department of the Army



U. S. DEPARTMENT OF COMMERCE
NATIONAL BUREAU OF STANDARDS

U. S. DEPARTMENT OF COMMERCE

Sinclair Weeks, Secretary

NATIONAL BUREAU OF STANDARDS

A. V. Astin, Director



THE NATIONAL BUREAU OF STANDARDS

The scope of activities of the National Bureau of Standards is suggested in the following listing of the divisions and sections engaged in technical work. In general, each section is engaged in specialized research, development, and engineering in the field indicated by its title. A brief description of the activities, and of the resultant reports and publications, appears on the inside of the back cover of this report.

Electricity. Resistance Measurements. Inductance and Capacitance. Electrical Instruments. Magnetic Measurements. Applied Electricity. Electrochemistry.

Optics and Metrology. Photometry and Colorimetry. Optical Instruments. Photographic Technology. Length. Gage.

Heat and Power. Temperature Measurements. Thermodynamics. Cryogenics. Engines and Lubrication. Engine Fuels. Cryogenic Engineering.

Atomic and Radiation Physics. Spectroscopy. Radiometry. Mass Spectrometry. Solid State Physics. Electron Physics. Atomic Physics. Neutron Measurements. Infrared Spectroscopy. Nuclear Physics. Radioactivity. X-Rays. Betatron. Nucleonic Instrumentation. Radiological Equipment. Atomic Energy Commission Instruments Branch.

Chemistry. Organic Coatings. Surface Chemistry. Organic Chemistry. Analytical Chemistry. Inorganic Chemistry. Electrodeposition. Gas Chemistry. Physical Chemistry. Thermochemistry. Spectrochemistry. Pure Substances.

Mechanics. Sound. Mechanical Instruments. Aerodynamics. Engineering Mechanics. Hydraulics. Mass. Capacity, Density, and Fluid Meters.

Organic and Fibrous Materials. Rubber. Textiles. Paper. Leather. Testing and Specifications. Polymer Structure. Organic Plastics. Dental Research.

Metallurgy. Thermal Metallurgy. Chemical Metallurgy. Mechanical Metallurgy. Corrosion.

Mineral Products. Porcelain and Pottery. Glass. Refractories. Enameled Metals. Concrete Materials. Constitution and Microstructure. Chemistry of Mineral Products.

Building Technology. Structural Engineering. Fire Protection. Heating and Air Conditioning. Floor, Roof, and Wall Coverings. Codes and Specifications.

Applied Mathematics. Numerical Analysis. Computation. Statistical Engineering. Machine Development.

Electronics. Engineering Electronics. Electron Tubes. Electronic Computers. Electronic Instrumentation.

Radio Propagation. Upper Atmosphere Research. Ionospheric Research. Regular Propagation Services. Frequency Utilization Research. Tropospheric Propagation Research. High Frequency Standards. Microwave Standards.

Ordnance Development. These three divisions are engaged in a broad program of research and development in advanced ordnance. Activities include basic and applied research, engineering, pilot production, field testing, and evaluation of a wide variety of ordnance matériel. Special skills and facilities of other NBS divisions also contribute to this program. The activity is sponsored by the Department of Defense.

Missile Development. Missile research and development: engineering, dynamics, intelligence, instrumentation, evaluation. Combustion in jet engines. These activities are sponsored by the Department of Defense.

● Office of Basic Instrumentation

● Office of Weights and Measures.

NATIONAL BUREAU OF STANDARDS REPORT

NBS PROJECT

0602-10-4716

October 9, 1953

NBS REPORT

2807

MECHANICAL TYPE DOOR INTERLOCK

by

Alfred B. Castle
Mechanical Instruments Section
Mechanics Division

Developed for

Engineering Division, Military Construction
Corps of Engineers
Department of the Army

MA448



The publication
unless permissi
25, D. C. Suc
prepared by th

Approved for public release by the
Director of the National Institute of
Standards and Technology (NIST)
on October 9, 2015.

or in part, is prohibited
Standards, Washington
ort has been specifically
report for its own use.

FOREWORD

Door interlocks of both mechanical and electrical types have been developed concurrently for the Engineering Division, Military Construction, Corps of Engineers, Department of the Army, during the present calendar year in the Mechanical Instruments Section principally under NBS Project No. 1000-10-4716 as authorized in the letters references (1) and (2). Only the mechanical type is described in this report.

The interlocks are designed primarily for use on multiple doors of a bathroom in veterans' hospitals 1) to lock the bathroom so as to afford privacy during occupancy, 2) to make it equally accessible to all potential users when idle, and 3) to open it easily in emergencies.

The text of the report was prepared principally by S.H.J. Womack, project supervisor.

Walter Ramberg, Chief
Mechanics Division

A. V. Astin, Director
National Bureau of Standards

MECHANICAL TYPE DOOR INTERLOCK

by

Alfred B. Castle

ABSTRACT

A mechanically operated door interlock specifically for use on two doors of a bathroom in veterans' hospitals was developed. The interlocks are separate from and obviate the need of ordinary door latches. With the interlocks, both doors to the bathroom can be locked by the occupant, and are unlocked when the bathroom is unoccupied. Several interlocks have been constructed and demonstrated in a laboratory installation. Design details are included in the report.

1. INTRODUCTION

Simple and automatic means for obtaining privacy for all parties concerned using one bathroom connecting between two or more rooms in hospitals has been a need particularly of U. S. Government operated hospitals.

The privacy desired is such that the user cannot be intruded upon from outside but when the room is not in use it remains equally available to all users. Also, in case of emergency the room should be easily opened from without.

Until the development of this mechanical interlock and the electrical type described in reference (3), no other hardware was known which would fit the need and yet be applicable to right and left hand doors regardless of relative location and also be simple and easy to operate. It had been reported that there is one commercial type of mechanical interlock which can be applied to two doors that are reasonably close together and opposite each other.

2. REQUIREMENTS

The interlocks, when installed on bathroom doors connected with two or more rooms, should meet the following minimum requirements:

- a). It should be possible to lock the bathroom doors from within against intrusion from without, simply by closing the doors and actuating a single handle or knob on any one door.
- b). Upon opening any one door, all doors must thereby become unlocked and remain so as long as any door remains open.
- c). While in the bathroom, locking any one door will simultaneously lock all other doors.
- d). When necessary it shall be possible to open any door from without by application of a simple tool or key.
- e). Breakage or slippage of the control cable shall either automatically unlock or permit emergency unlocking of all doors.
- f). The materials, workmanship and design of the locks shall afford a reasonably long trouble-free life.

The following additional features are desirable:

- g). An indicator that the bathroom is occupied should be easily visible from both connecting rooms.
- h). The locks should be applicable to either old or new construction and dispense with the use of existing types of hardware.
- i). Locking knobs or handles should be preferably similar to those normally used to obviate learning any new locking technique.

3. PRINCIPLE OF OPERATION AND DESCRIPTION

The principle of operation of this type of interlock will be explained in connection with its description.

In the locked condition the external opening handle 18, figure 2, is made ineffective against normal attempt at opening due to each tongue 7 acting to block movement of bolt 8 of either door. Refer to figure 1.

To unlock the doors, either internal handle is turned back to the horizontal or neutral position. From this position the bolt of either door may be retracted by sliding the handle toward the hinge line of the door for which slot A is provided in part 1. The doors may be opened from without by turning the handle to secure a similar sliding action and as shown at the upper right, figure 3. The mechanism is now ready for the next cycle of operation.

3.1 Door Units of Interlock

The latch bolt 8, figures 1 and 5, may be of circular but preferably of rectangular cross-section. It acts as a conventional latch, entering an opening in the face plate of the jamb unit under force of the springs 13

when the door is closed. The bolt is attached to a locking tongue or link which fits freely in a slot of the interlock ring segment 5 and may enter the rectangular slot 1A and 1B, figure 1. This occurs when moved hingeward by the handle 17 or 18 only when the doors are in the unlocked position. A ball, socket and spring unit 14 helps locate this position.

The turning of tongue 7 about the axis of the handle shaft deflects ring segment 5 so as to rotate the shorter concentric ring segment 6 in the jamb unit. Conversely a rotation of segment 6 arising from the remote lock causes segment 5 to rotate and deflect tongue 7.

Associated with the unit mortised into the door is the "lock side" handle 17, figure 2, which is provided with a square shaft. The shaft fits through the square hole in part 7. The ring 5 and tongue 7 can be rotated either direction through a limited angle from the horizontal either directly by rotating the handle or indirectly by action of the ring segments as already mentioned and illustrated in figure 3.

3.2 Jamb Units of Interlock

The hardware of the jamb part of the interlock consists mainly of a housing with an opening for a latch bolt, an interlock ring unit and a cable connector unit. The ring unit consists principally of the ring segment 6, a locking pawl 11 mounted and spring held in a notch of the connector arm 9 when the door bolt is not engaged with the jamb unit. Normally the turning of 6 at either door moves 9 in both doors up or down corresponding to the direction of the rotation because the transmitting wire in 15 is attached to connector 9 at each of its ends.

Movement of 9 in the jamb remote from the operator deflects the wire which in turn rotates ring segment 6, one end of which becomes extended beyond the jamb face. In so moving it deflects (rotates) ring segment 5 in the remote door and locks the door bolt 8 as securely as if it had been turned directly by its handle.

A safeguard has been incorporated in the design against closing and locking one door while the other is left open. This is the function of the pawl 11 in the jamb unit. Normally it locks part 9 first, and then part 6 against movement if the door bolt 8 is not fully in its socket. If the bolt is in, meaning that the door is closed, the crank arm 11 is disengaged by a cam action from 9 and permits the closing of the remote door.

The interlock pawl is somewhat accessible for "picking" through the latch bolt opening, but two persons, one at each door, will be required to lock one door independent of locking the other and thus circumvent the normal functioning of the locks. To make the picking of the interlock more difficult would probably unduly complicate the device. However, unless the mechanism is damaged, the units will function properly even after tampering.

The deflection transmitting cable 15 is a type familiar to the automotive and marine industry. It is important that the wire make a close but free fit inside the casing; excessive friction or looseness would introduce trouble in moving the elements of the remote door to the proper position for opening. The connector 9 moves in guides 10, figure 5.

4. INSTALLATION DETAILS

The mechanical interlock system may be installed in old but preferably in new work, in mortices or molded recesses made in accordance with the template, figure 4. In old work, the ordinary latch bolt should be removed or secured in the retracted position. Identically constructed units are installed at each door, care being taken that each door unit is so mounted that the latch bolt operates normally and that the jamb unit has such orientation as to make the interlock pawl engage properly with the latch bolt. The housing of all units are symmetrical about a horizontal axis and therefore may be inserted as required to effect the proper engagement of the pawl with the longer side of the bolt.

The transmitting cable 15 may be connected either from above or from below. The guide pieces 10 and the clamping arm 9, figure 5, have clamps at either end to accommodate the cable. Piece 10 is attached to piece 2 by two horizontal screws. For installation in new concrete or similar construction a roughing-in box should be mounted in the jamb and a conduit or tube of $3/8$ inch bore or larger should be connected between boxes. The roughing-in box should be $1\ 1/2$ " wide x $2\ 1/2$ " deep x 6" high, and have a knockout with its center located 2" from the face and $3/4$ " from the sides on both top and bottom. For best results the total length of conduit path should not exceed 25 feet and the minimum radius of bend should be 6 inches.

The handles 17 and 18, figure 2, are installed on the inside and outside of the door, respectively, by means of a set of screws, washers and the collar 19. The end of the collar and shaft are painted, like a half moon, for example, to indicate whether the door is locked or not, depending on the rotated position of the square shaft.

5. OPENING OF LOCKED DOORS

5.1 Normal Opening

Either door of the bathroom is unlocked simply by turning the control handle in the direction required to return the handle to the horizontal position. For doors of maximum separation a slight overthrow of the handle and then a return of it to the horizontal may be required if too much slack or backlash is allowed in the system or a shrinkage in the width of the door occurs. With the handle horizontal, the door may be opened by sliding the handle toward the hinges of the door enough to clear the bolt from the jamb.

Incidentally, turning the handle well beyond the horizontal position in the direction required initially to unlock the door does no harm; the doors simply became relocked in the alternate position as shown in figure 3.

5.2 Emergency Opening

Either door may be unlocked from without simply by applying the special tool 16, figure 2, on the exposed end of the shaft to rotate it to a horizontal position. The door may then be opened by operating the handle on the outside of the door.

6. EXTENSION TO MORE THAN TWO DOORS

The interlock although made initially for use on two doors can be extended theoretically to apply to any number of doors but practically to only three or possibly four doors. In the case of more than two doors the limitation on the total length (25 ft approx.) of connecting cable must be observed. The backlash is a function of the total length of cable and is limited principally by the tolerance in the fit of the interlocking parts 9 and 11, figures 1 and 5.

7. SUMMARY

A mechanically operated door interlock for locking and unlocking two doors simultaneously has been developed which meets all the essential requirements stated in section 2, above. The interlock is generally better adaptable to new than to old construction.

To effect locking, metallic segments which are linked to the remote end of an ordinary type bolt in each door are operated directly at one door by a handle and remotely at the other door by a jamb segment which is concentric with the door segment. Remote locking action is transmitted by means of a steel wire within a flexible metallic sheath. The operating handle requires a twisting motion to lock and unlock and a sliding motion to open the door. A bolt released interlock prevents locking of one door with the other door open.

With the commercial type of cable used the lost motion in a length of the cable and the necessary tolerance in the fit of the door with the jamb and in the fit of the interlocking parts limit the number of doors to about three and the total length of cable to about 25 feet.

The NBS developed mechanical interlock requires more torque to operate the control handles and is not so applicable to old construction as the NBS electrical interlock, reference 3, which was developed concurrently with the mechanical type. The mechanical type however, has no inherent shock hazard and is independent of electrical failure.

8. REFERENCES

1. Letter from Engineering Division, Military Construction, Corps of Engineers, Department of the Army, dated January 13, 1953, reference ENGES.
2. Letter from Engineering Division, Military Construction, Corps of Engineers, Department of the Army, dated May 13, 1953, reference ENGES.
3. NBS Report No. 2806 on Electrical Type Door Interlock, dated September 21, 1953.

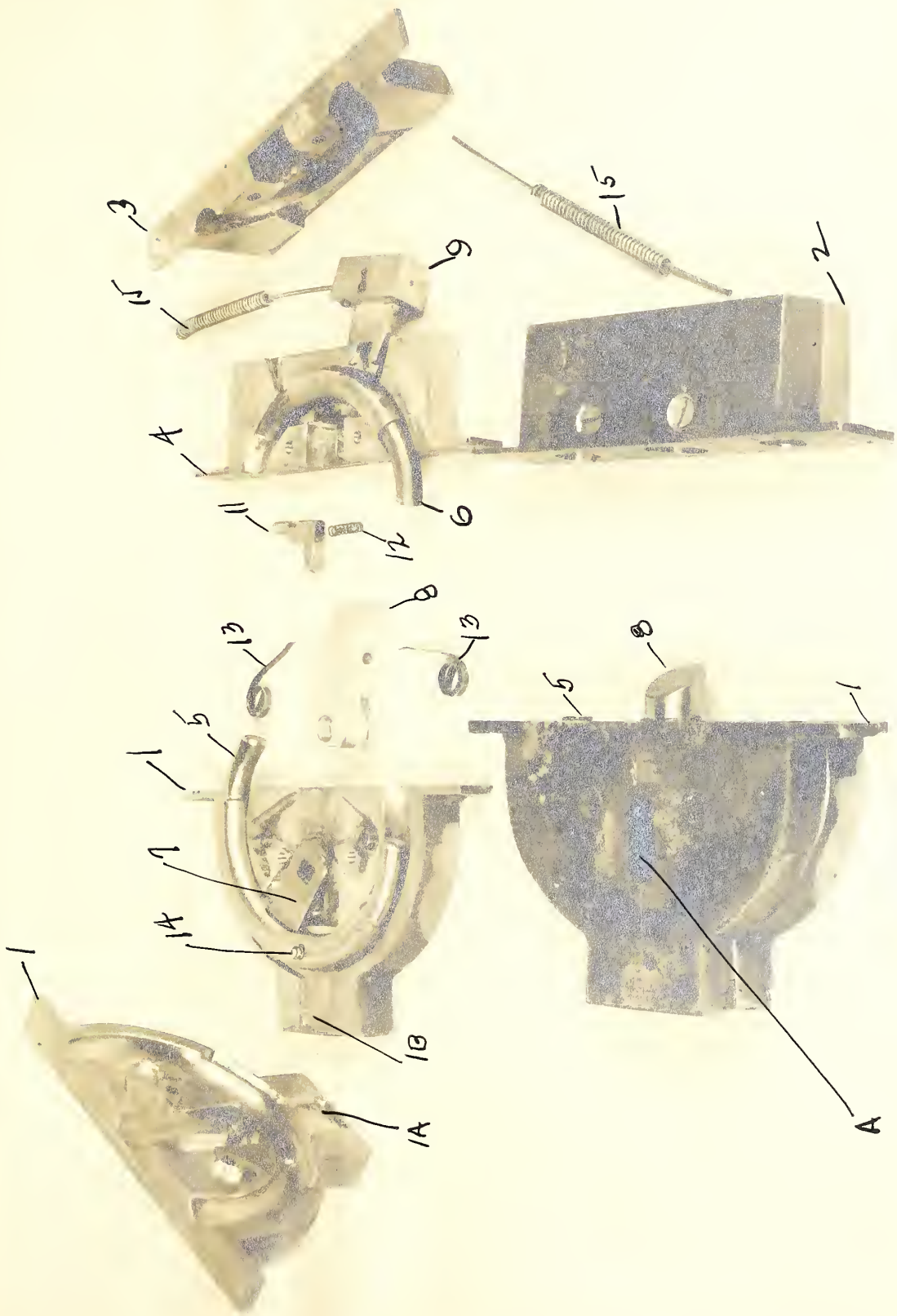
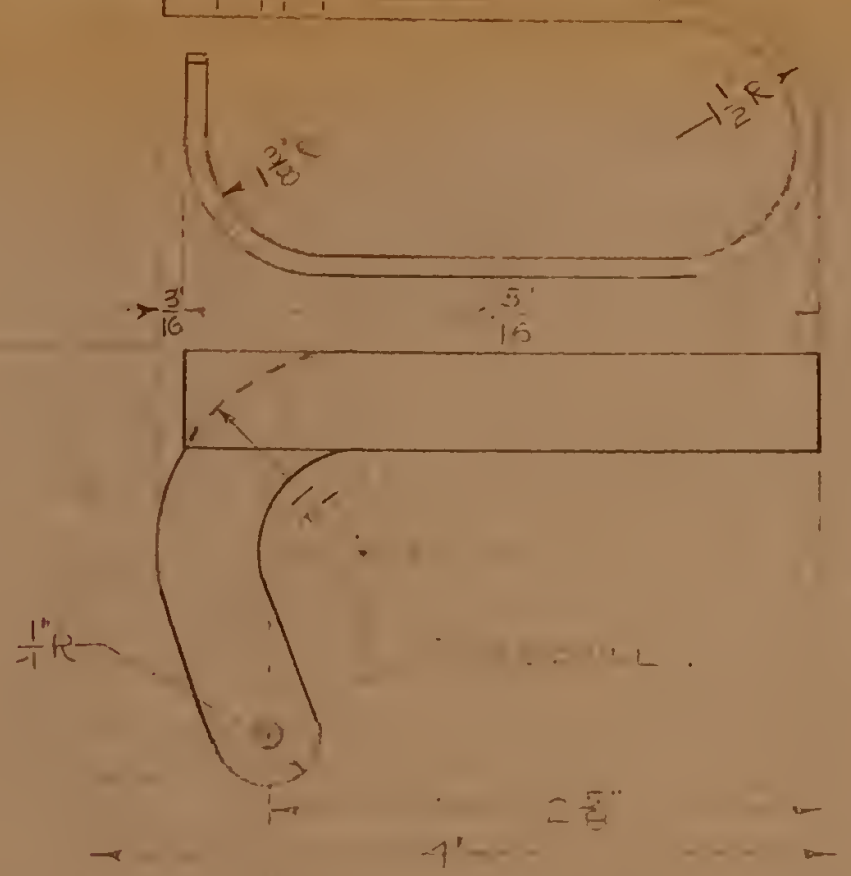

FIG. 1

ORIGINAL DATE OF DRAWING			
REVISIONS			
NO	E C N	CHANGE	DATE
1			
2			
3			
4			

OPENING HANDLE



(18)

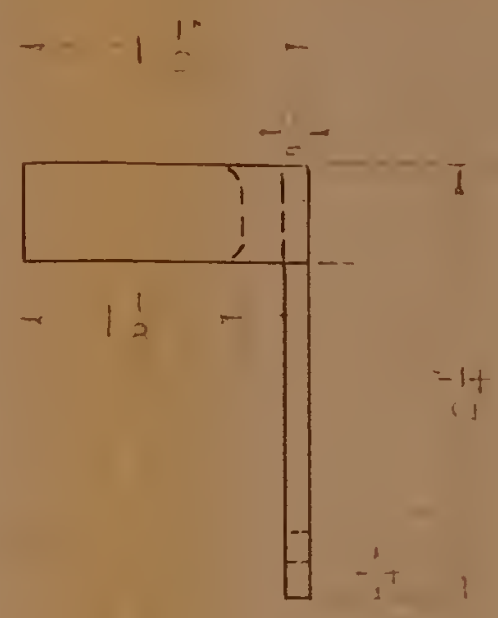

REF. DW'G 858

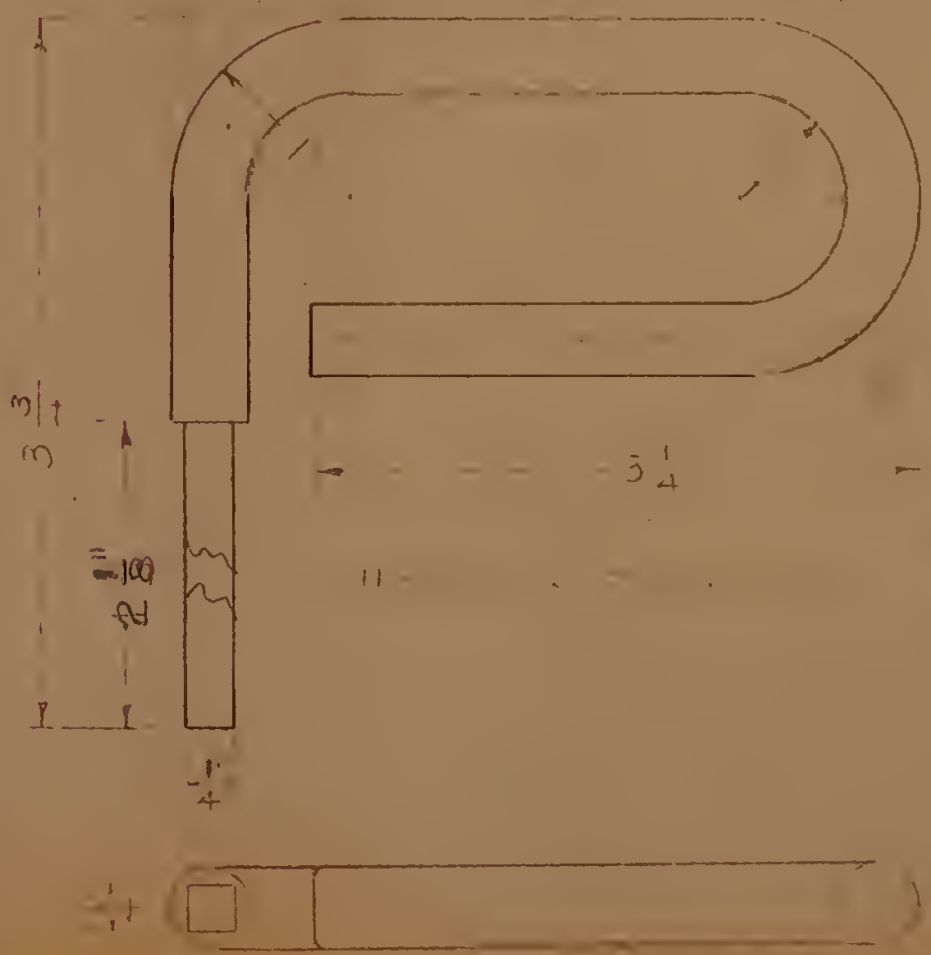

17

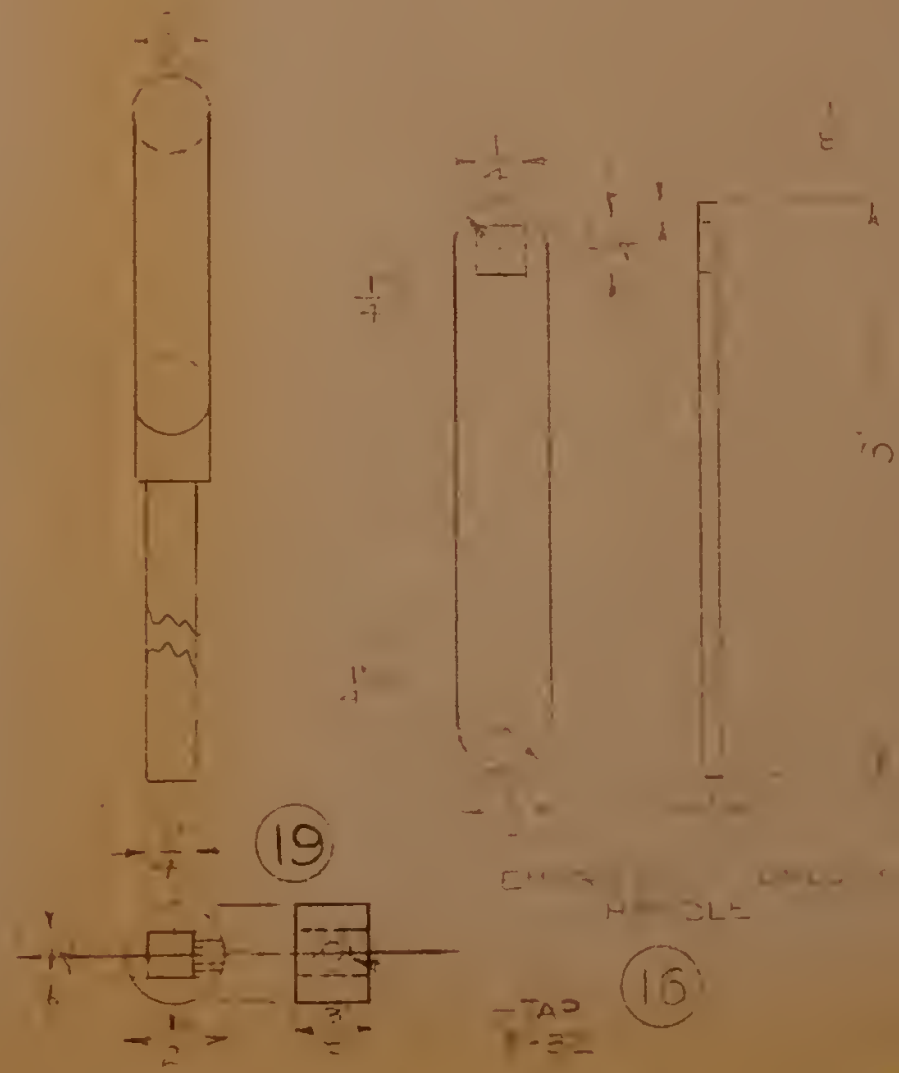

(19)

(16)

PIECE NO.	NOMENCLATURE	NO. RED'D
NATIONAL BUREAU OF STANDARDS WASHINGTON 25, D. C.		
MULTIPLE LOOK PARTS FOR MECHANICAL		
MODEL	TYPE	SCALE
DIMENSIONS IN INCHES (Unless otherwise specified)	DRAFTSMAN	CHECKER
TOLERANCES (Unless otherwise specified)	PROJECT ENGR.	PROJECT ENGR.
DECIMALS ±.008	SUBMITTED BY	
FRACTIONS ±.015	CHIEF, SEC.....	
ANGLES ±1/2°	EXAMINED BY	
DO NOT SCALE THIS PRINT	CHIEF ENGINEER	
DIV. SEC.	THIS PRINT ISSUED	APPROVED BY
6-		CHIEF, DIV.....
		862/FIG.2

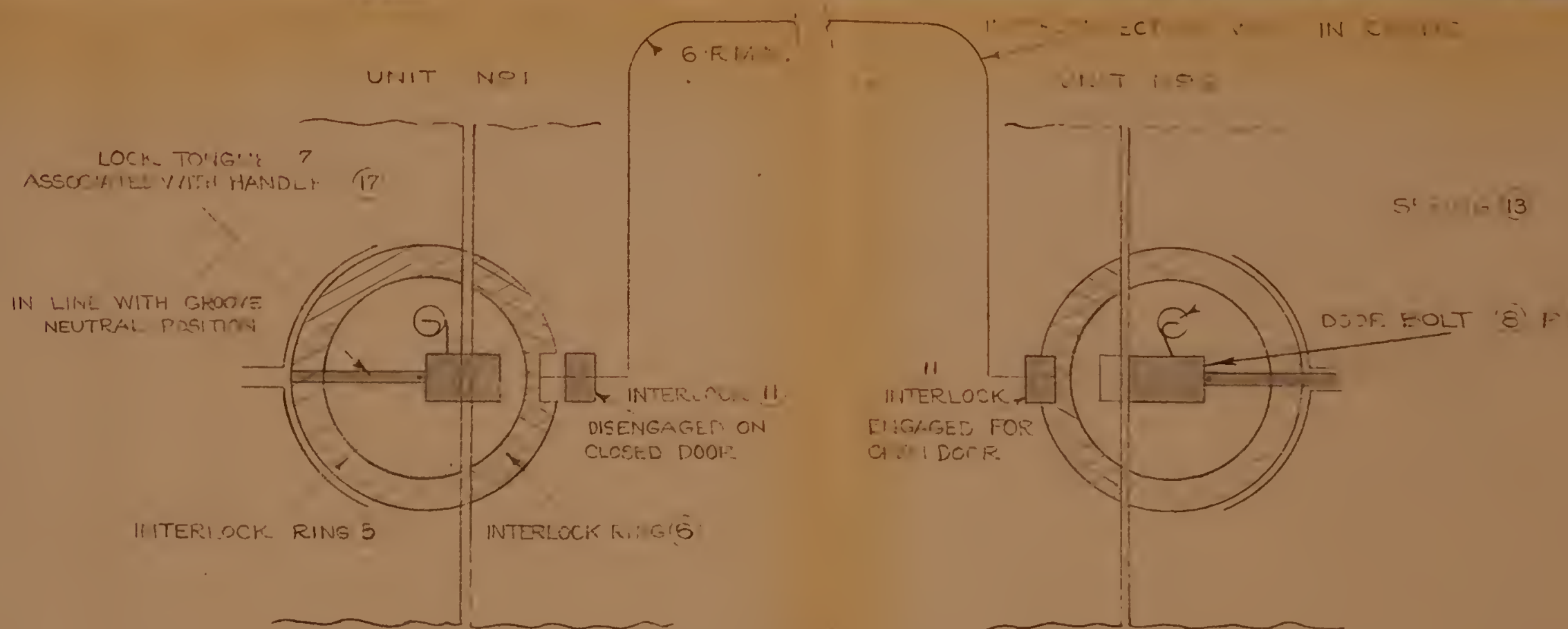

ORIGINAL DATE OF DRAWING			
REVISIONS			
NO.	E C N	CHANGE	DATE
1			
2			
3			
4			

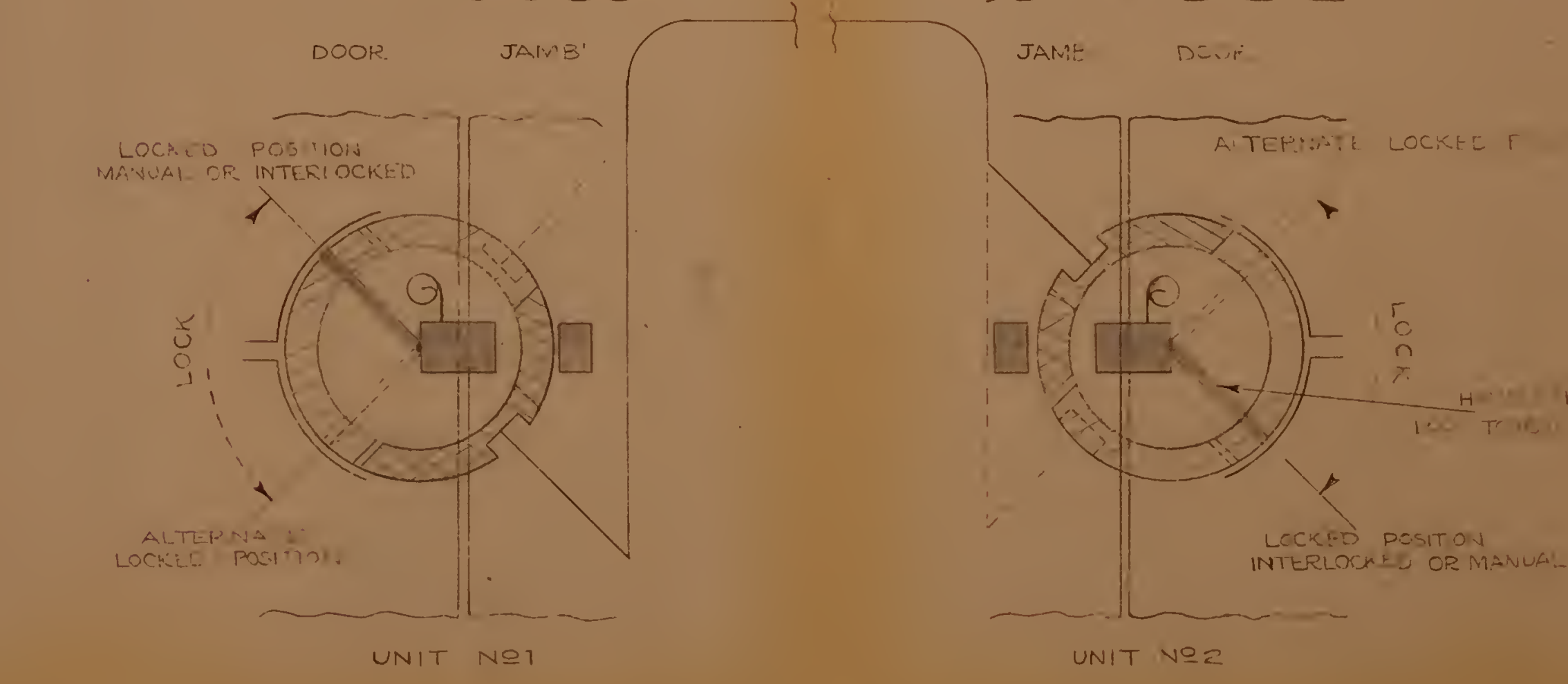

PIECE NO.	NOMENCLATURE	NO. REQ'D
NATIONAL BUREAU OF STANDARDS WASHINGTON 25, D. C.		
MULTIPLE DOOR INTERLOCK		
FOR MILITARY - SCIENTIFIC		
MODEL 2	TYPE 1	SCALE 2
DIMENSIONS IN INCHES (Unless otherwise specified)	DRAFTSMAN ABC	CHECKER
TOLERANCES (Unless otherwise specified)	PROJECT ENGR. ABC	PROJECT ENGR. SHW
DECIMALS ±.008	SUBMITTED BY	
FRACTIONS ±.018	CHIEF, SEC.	
ANGLES +1/2°	EXAMINED BY	
DO NOT SCALE THIS PRINT		CHIEF ENGINEER
DIV. SEC.	THIS PRINT ISSUED	APPROVED BY
62		CHIEF, DIV.
		859/FIG. 3

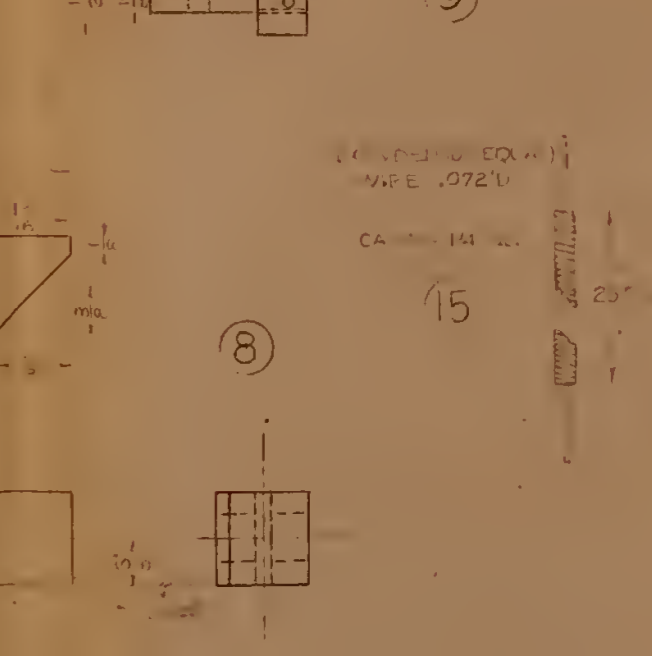
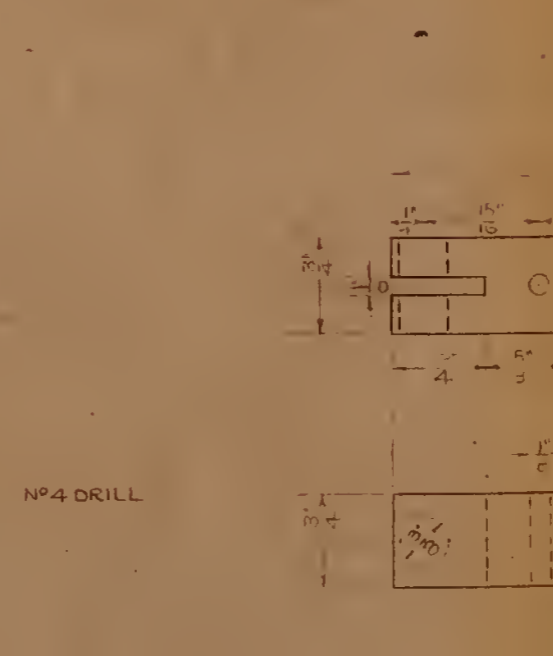
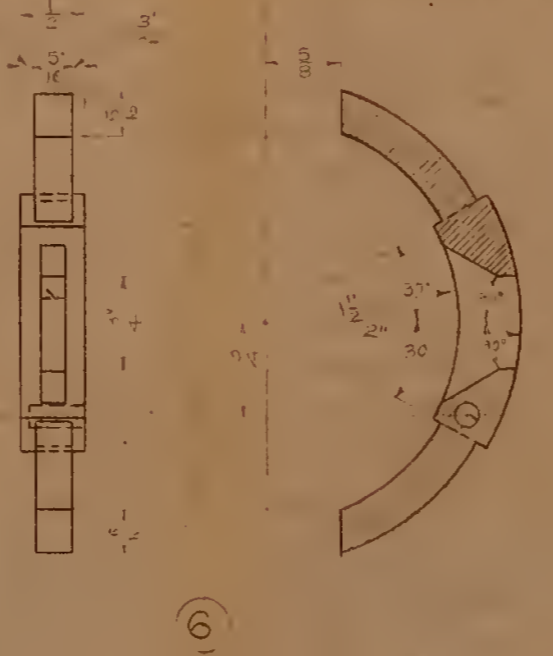
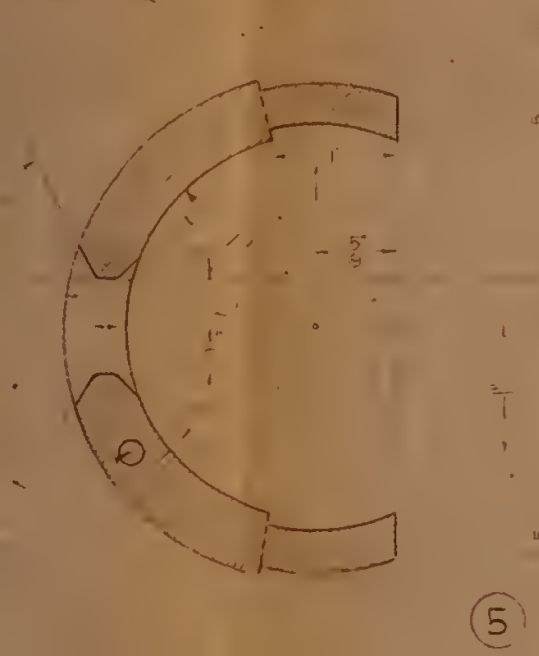
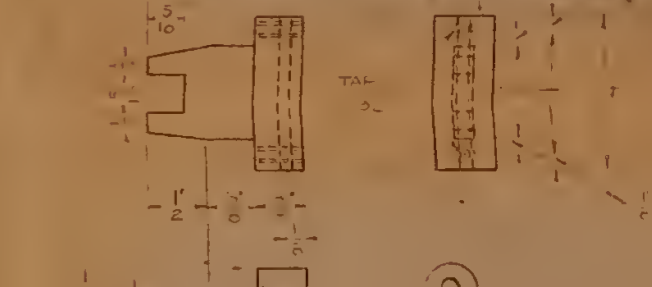
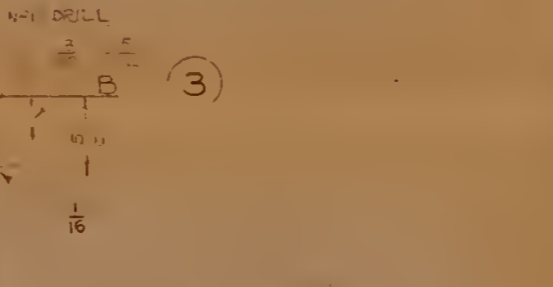
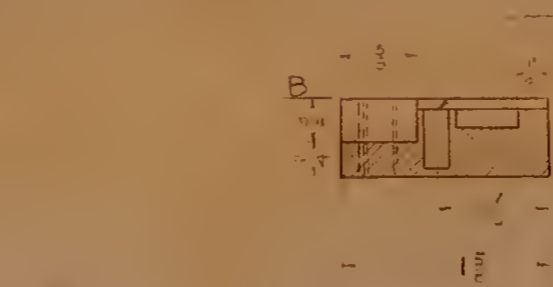
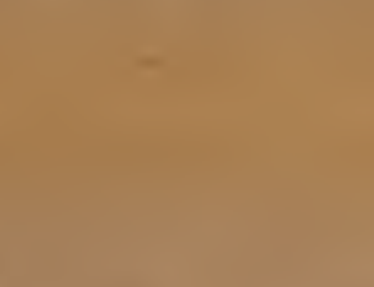
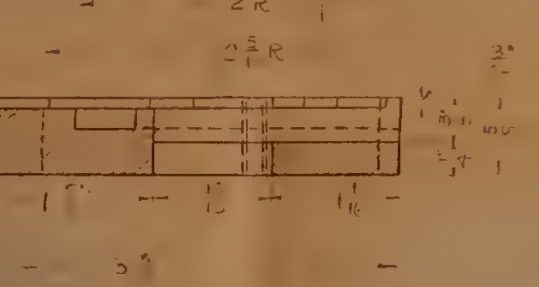
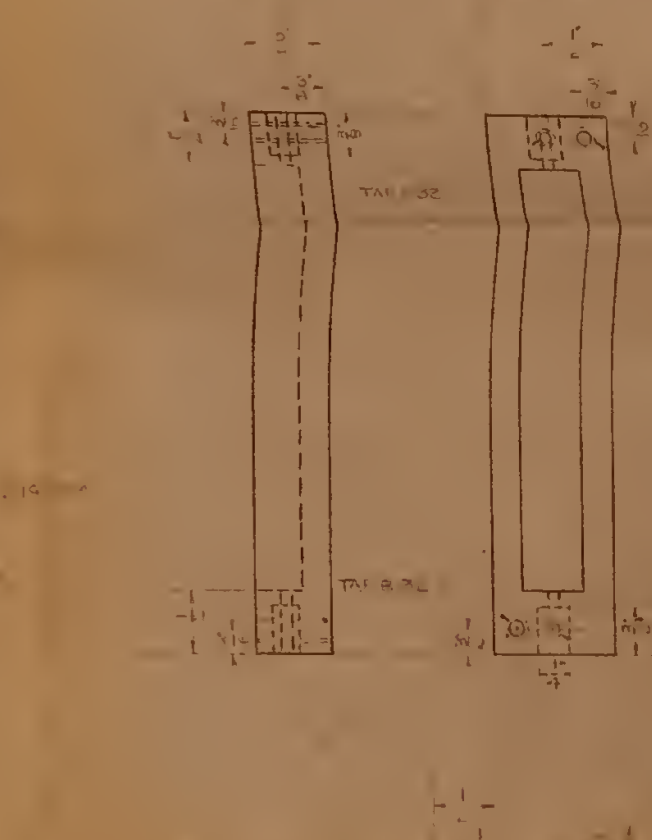
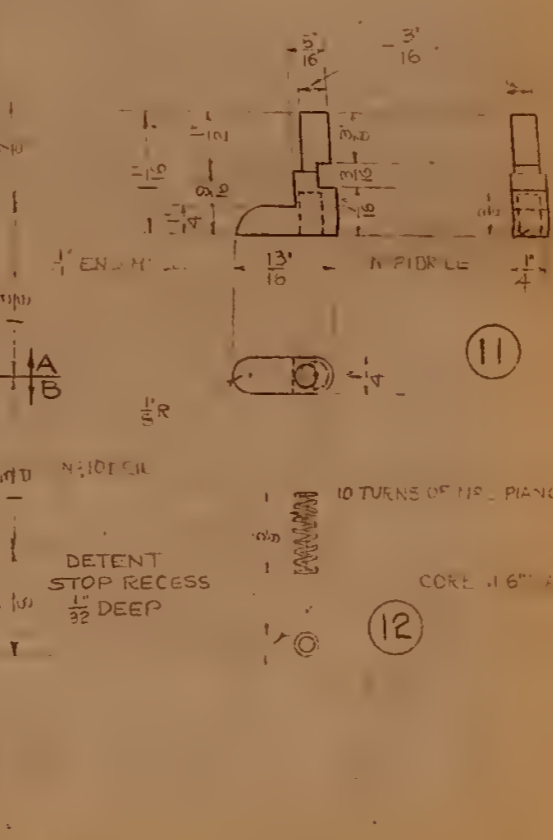
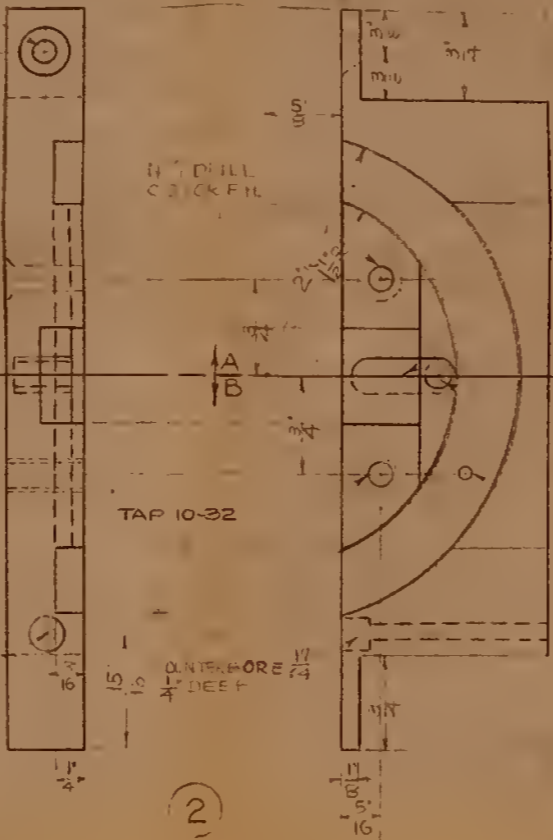
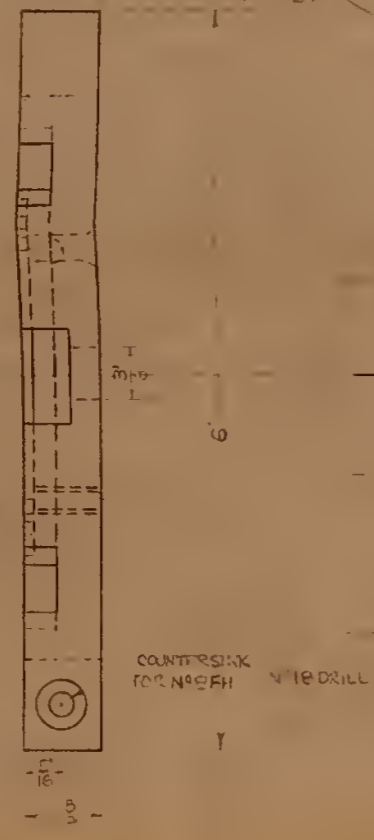
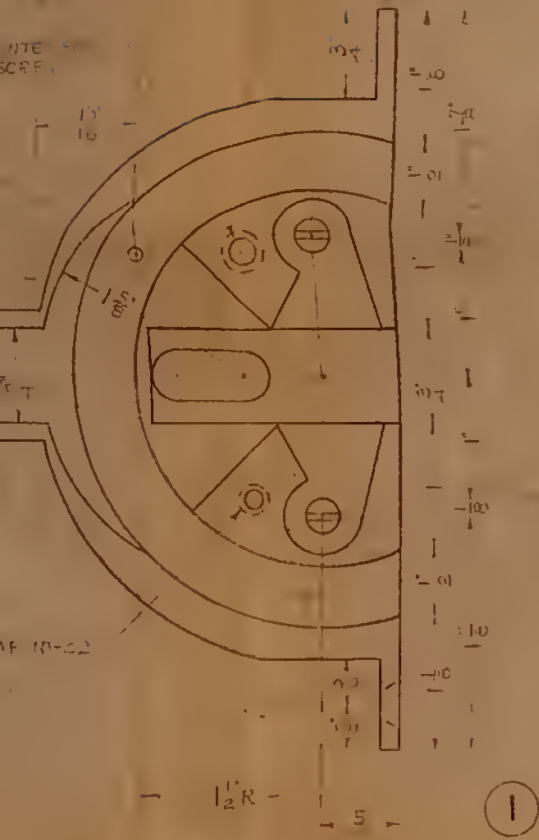

CONVEX EQU
WIRE .072"
CAL. 141

THE NATIONAL BUREAU OF STANDARDS

Functions and Activities

The functions of the National Bureau of Standards are set forth in the Act of Congress, March 3, 1901, as amended by Congress in Public Law 619, 1950. These include the development and maintenance of the national standards of measurement and the provision of means and methods for making measurements consistent with these standards; the determination of physical constants and properties of materials; the development of methods and instruments for testing materials, devices, and structures; advisory services to Government Agencies on scientific and technical problems; invention and development of devices to serve special needs of the Government; and the development of standard practices, codes, and specifications. The work includes basic and applied research, development, engineering, instrumentation, testing, evaluation, calibration services, and various consultation and information services. A major portion of the Bureau's work is performed for other Government Agencies, particularly the Department of Defense and the Atomic Energy Commission. The scope of activities is suggested by the listing of divisions and sections on the inside of the front cover.

Reports and Publications

The results of the Bureau's work take the form of either actual equipment and devices or published papers and reports. Reports are issued to the sponsoring agency of a particular project or program. Published papers appear either in the Bureau's own series of publications or in the journals of professional and scientific societies. The Bureau itself publishes three monthly periodicals, available from the Government Printing Office: The Journal of Research, which presents complete papers reporting technical investigations; the Technical News Bulletin, which presents summary and preliminary reports on work in progress; and Basic Radio Propagation Predictions, which provides data for determining the best frequencies to use for radio communications throughout the world. There are also five series of nonperiodical publications: The Applied Mathematics Series, Circulars, Handbooks, Building Materials and Structures Reports, and Miscellaneous Publications.

Information on the Bureau's publications can be found in NBS Circular 460, Publications of the National Bureau of Standards (\$1.00). Information on calibration services and fees can be found in NBS Circular 483, Testing by the National Bureau of Standards (25 cents). Both are available from the Government Printing Office. Inquiries regarding the Bureau's reports and publications should be addressed to the Office of Scientific Publications, National Bureau of Standards, Washington 25, D. C.

