

INTERCOMPARISON OF LOAD CELL VERIFICATION TESTS PERFORMED BY NATIONAL LABORATORIES OF FIVE COUNTRIES

**Richard A. Mitchell
Simone L. Yaniv
Kenneth Yee**

**U.S. DEPARTMENT OF COMMERCE
National Institute of Standards
and Technology
National Engineering Laboratory
Center for Manufacturing Engineering
Automated Production Technology Division**

Otto K. Warnlof

**U.S. DEPARTMENT OF COMMERCE
National Institute of Standards
and Technology
Office of the Director
Associate Director for Industry
and Standards
Office of Standards Management
Gaithersburg, MD 20899**

**U.S. DEPARTMENT OF COMMERCE
Robert A. Mosbacher, Secretary
NATIONAL INSTITUTE OF STANDARDS
AND TECHNOLOGY
Raymond G. Kammer, Acting Director**

QC
100
.U56
89-4101
1989

NIST

NATIONAL INSTITUTE OF STANDARDS &
TECHNOLOGY
Research Information Center
Gaithersburg, MD 20899

DATE DUE

INTERCOMPARISON OF LOAD CELL VERIFICATION TESTS PERFORMED BY NATIONAL LABORATORIES OF FIVE COUNTRIES

NISTC
26100
USA
10. 31-11011
1989
L2

**Richard A. Mitchell
Simone L. Yaniv
Kenneth Yee**

**U.S. DEPARTMENT OF COMMERCE
National Institute of Standards
and Technology
National Engineering Laboratory
Center for Manufacturing Engineering
Automated Production Technology Division**

Otto K. Warnlof

**U.S. DEPARTMENT OF COMMERCE
National Institute of Standards
and Technology
Office of the Director
Associate Director for Industry and
Standards
Office of Standards Management
Gaithersburg, MD 20899**

August 1989



**U.S. DEPARTMENT OF COMMERCE
Robert A. Mosbacher, Secretary
NATIONAL INSTITUTE OF STANDARDS
AND TECHNOLOGY
Raymond G. Kammer, Acting Director**

FOREWORD

The Load Cell Intercomparison Program was initiated by the National Institute of Standards and Technology (NIST) Office of Standards Management. Its aim was to compare the results of type evaluation tests on load cells conducted by various laboratories following the OIML International Recommendation R60 "Load Cells." The ultimate goal was that it would serve as the technical basis for the development of a "Memorandum of Understanding" amongst the participating nations, so that the results of a test on a load cell by a participating nation would be mutually recognized by the other participants in the type evaluation process. This would provide for an effective and efficient allocation of the limited resources available to government entities, would provide economies to load cell manufacturers, and would significantly reduce technical barriers to trade.

ACKNOWLEDGEMENTS

Program management was provided by the NIST Office of Standards Management, technical support by the NIST Automated Production Technology Division, and industrial liaison by the Scale Manufacturers Association. The following U.S. manufacturers provided \$43,000 in financial assistance:

Hottinger Baldwin Measurements, Inc.
Revere Corporation of America
Transducers, Inc.
BLH Electronics
Weigh-Tronix, Inc.
Ohaus Corporation
John Chatillon & Sons, Inc.

The national laboratories that performed the load cell verification tests and served as a pivot laboratory are:

National Standards Commission, Australia
Physikalisch-Technische Bundesanstalt, Federal Republic of Germany
Dienst van het IJkwezen, the Netherlands
National Weights and Measures Laboratory, the United Kingdom
National Institute of Standards and Technology, the United States

The manufacturers that performed some of the load cell verification tests under the supervision of a national laboratory are:

W&T Avery, UK
Toledo Scale, USA

The load cells that were tested were provided by:

W&T Avery, UK
Bizerba, FRG
Hottinger Baldwin Messtechnik GmbH, FRG
Molen, the Netherlands
Revere Corporation of America, USA
Transducers, Inc., USA

The computer program used by NIST to analyze all of the test data was developed by Clare W. Amoruso, NIST Automated Production Technology Division.

Table of Contents

	<u>Page</u>
List of Tables	vii
Abstract	1
1. INTRODUCTION	1
2. TEST CONDITIONS	2
2.1. Measurement Uncertainty	2
2.2. Test Loading	3
2.3. Temperature Control	3
2.4. Readout Instrumentation	3
3. TEST PROCEDURE	3
3.1. Load Cycle Test	4
3.2. Minimum Dead Load Output Return Test	4
3.3. Creep Test	5
3.4. Pressure Sensitivity Test	5
4. DATA ANALYSIS ALGORITHM	6
4.1. Load Cycle Test	7
4.1.1. Combined Error	8
4.1.2. Repeatability Error	9
4.1.3. Temperature Effect on Minimum Dead Load Output	11
4.2. Minimum Dead Load Output Return Test	11
4.3. Creep Test	12
4.4. Pressure Sensitivity Test	13
5. TEST RESULTS	13
5.1. 25000 kg Load Cell	21
5.2. 20000 kg Load Cell	21
5.3. 1500 kg Load Cell	22
5.4. 500 kg Load Cell	22
5.5. 200 kg Load Cell	22
5.6. 18 kg Load Cell	22
6. PIVOT LABORATORY REPORTS	23
6.1. 25000 kg Load Cell	23
6.2. 20000 kg Load Cell	23
6.3. 1500 kg Load Cell	24
6.4. 500 kg Load Cell	24
6.5. 200 kg Load Cell	24
6.6. 18 kg Load Cell	24
7. CONCLUSIONS	25
APPENDIX A: Pivot Laboratory Report--25000 kg Load Cell	A-1
APPENDIX B: Pivot Laboratory Report--20000 kg Load Cell	B-1

Table of Contents (Continued)

	<u>Page</u>
APPENDIX C: Pivot Laboratory Report--1500 kg Load Cell	C-1
APPENDIX D: Pivot Laboratory Report--500 kg Load Cell	D-1
APPENDIX E: Pivot Laboratory Report--200 kg And 18 kg Load Cells	E-1

List of Tables

	<u>Page</u>
Table 1. Characteristic critical ratio -- 25000 kg load cell analyzed for 3000v	15
Table 2. Characteristic critical ratio -- 20000 kg load cell analyzed for 3500v	16
Table 3. Characteristic critical ratio -- 1500 kg load cell analyzed for 2500v	17
Table 4. Characteristic critical ratio -- 500 kg load cell analyzed for 3500v	18
Table 5. Characteristic critical ratio -- 200 kg load cell analyzed for 2500v	19
Table 6. Characteristic critical ratio -- 18 kg load cell analyzed for 6000v	20
Table 7. Maximum number of verification intervals	21

INTERCOMPARISON OF LOAD CELL VERIFICATION TESTS PERFORMED BY NATIONAL LABORATORIES OF FIVE COUNTRIES

Richard A. Mitchell
Simone L. Yaniv
Kenneth Yee
Otto K. Warnlof

ABSTRACT

A round-robin intercomparison of OIML IR 60 load cell verification tests, as performed by national laboratories of five countries, is reported. The five participating countries were Australia, the Federal Republic of Germany, the Netherlands, the United Kingdom, and the United States. Six OIML Class C load cells, ranging in capacity from 18 kg to 25000 kg, were tested by the five laboratories. The objective was to determine the comparability of the results from the verification test processes of the five laboratories, so that the laboratories could accept the results from any one laboratory and avoid the cost of retesting. Overall, the test results indicate reasonably good agreement among the five laboratories in the measurement of most of the characteristics of the six load cells. The degree and pattern of the differences in the results can serve as a guide to making refinements in the verification test processes.

KEY WORDS: International intercomparison; legal metrology; load cell; load cell verification test; OIML IR 60 "Load Cells"; weighing instruments.

1. INTRODUCTION

Verification tests were performed on a set of six different load cells by national laboratories of five countries.¹ While the tests generally followed the International Recommendation Number 60 (IR 60) of the International Organization of Legal Metrology (OIML), additional test requirements were prescribed in this intercomparison. These included requirements for an additional test temperature, a specific temperature sequence, a specific loading sequence, and other test conditions. In some cases the tests were not performed precisely as prescribed because of limitations in the loading machines and temperature control systems.

The objective of this program was to determine the comparability of the results from the load cell verification test processes of the five participating laboratories. The program focus was on the measurement process rather than on the intercomparison of the loading machines and other laboratory equipment. The underlying purpose of the program was to develop, experimentally, the rationale for a national laboratory of one country to use, as a basis for load cell acceptance and classification, test data obtained in a national laboratory of another country.

¹One of the load cells was tested by only three of the laboratories.

The following six OIML Class C load cells were tested:

- a. 18 kg capacity, single-cantilever beam type, manufactured in the Federal Republic of Germany (FRG).
- b. 200 kg capacity, single-cantilever beam type, manufactured in the United States of America (USA).
- c. 500 kg capacity, single-cantilever beam type, manufactured in the USA.
- d. 1500 kg capacity, single-cantilever beam type, manufactured in the United Kingdom (UK).
- e. 20000 kg capacity, canister compression type, manufactured in the FRG.
- f. 25000 kg capacity, canister compression type, manufactured in the Netherlands.

The five participating laboratories were:

- a. National Standards Commission (NSC), Australia.
- b. Physikalisch-Technische Bundesanstalt (PTB), FRG.
- c. Dienst van het IJkwezen (WT), the Netherlands.
- d. National Weights and Measures Laboratory (NWML), UK. The tests were performed under the supervision of NWML by the Avery, Ltd. laboratory (Tamebridge, England).
- e. National Institute of Standards and Technology (NIST), formerly the National Bureau of Standards, USA. The tests of the 200, 500, and 1500 kg load cells were performed under the supervision of NIST by the Toledo Scale laboratory (Columbus, Ohio).

2. TEST CONDITIONS

Although the test conditions prescribed for this intercomparison, described in Sections 2.1. through 2.4. below, were generally consistent with the requirements of IR 60, additional requirements were imposed in an effort to reduce the between-laboratory differences in test data, and to allow for a more precise numerical comparison of results. The agreed upon requirements are listed below.

2.1. Measurement Uncertainty

The combined measurement uncertainty of the loading machine and the readout instrument, at a particular test load, was to be less than 0.3 times the maximum permissible error of the load cell under test.

2.2. Test Loading

The test loads were to be generated by standard test weights. Therefore, the forces sensed by a given load cell depended on the local gravity field and on the density of the test weights and the surrounding air. In order to compare precisely the test results obtained at different laboratories, it was necessary to convert the test loads to a common loading unit that is proportional to force. Accordingly, the program required that the local gravity constant (g), the density of the test weights (D), and the estimated mean air density during the test (d) be reported along with the test data, unless the test loads were reported in force units.

2.3. Temperature Control

The tests were to be conducted, as nearly as practicable, at the target temperatures of 20, 40, -10, 5, and 20 °C, and in that temperature sequence. During a test, the temperature was to be held within ± 2 °C of the target temperature while the variation of temperature during a test was to be no greater than ± 1 °C. The temperature soak time, after the temperature had been adjusted to be within ± 2 °C of the target temperature, before a test was begun, was to be recorded.

2.4. Readout Instrumentation

The output of the load cell was to be measured with a stable linear readout instrument whose calibration was periodically verified. The manufacturer, model, serial number, excitation voltage, and frequency of the readout instrument were to be reported. The readout instrument was to be located outside the temperature chamber and maintained at a stable room temperature. The load cell was to be energized continuously throughout the entire series of tests.

The readout instrument was to be connected to the integral load cell cable by a 6-wire instrument cable. The load cell cable was to be coiled loosely around the load cell and extended, outside the temperature chamber, no more than necessary to connect to the readout instrument cable at a terminal strip to be located at least 5 cm from the temperature chamber. The length of the cable outside the temperature chamber was to be reported. The terminal strip and the section of the load cell cable outside the temperature chamber was to be anchored securely to prevent any change in the length of cable outside the chamber.

3. TEST PROCEDURE

A complete load cell verification consists of the following tests: (1) load cycle, (2) minimum dead load output return, (3) creep, and (4) pressure sensitivity. In this intercomparison each one of the first three tests was conducted in the sequence listed above, first at 20 °C and then at 40, -10, and 5 °C; then only the load cycle test was repeated at 20 °C. The pressure sensitivity test was conducted only at room temperature and independently of the other three tests. The detailed procedures prescribed for conducting each test at a particular temperature follow.

3.1. Load Cycle Test

The load cycle test consisted of three complete load-unload cycles between the minimum dead load and the maximum test load, at each test temperature. This test allows for a determination of: (1) the combined error due to nonlinearity, hysteresis, and temperature effect on sensitivity; (2) the repeatability error; and (3) the temperature effect on minimum dead load output. At each test temperature, the procedure called for the following steps:

- a. After a stable temperature was achieved and an adequate soaking time was allowed, the load cell was exercised by applying the maximum test load three times, returning to minimum dead load after each maximum load application.
- b. The load cell was allowed to rest for 5 minutes at minimum dead load.
- c. The load cell output, the test temperature, and the barometric pressure were recorded at minimum dead load.
- d. Test loads were applied in at least 5 increments to maximum test load, applying the loads at approximately equal time intervals.
- e. Load cell outputs were recorded at each ascending test load, at a time following the application of the load increment that corresponded, as nearly as practicable, to the times listed in point 7 of OIML IR 60.
- f. Test loads were removed in increments to minimum dead load, as in step d above.
- g. Load cell outputs were recorded at each descending test load, as in step e above.
- h. The load cell output, the test temperature, and the barometric pressure were recorded upon returning to minimum dead load.
- i. Steps c through h were repeated two more times at the same test temperature. Then the minimum dead load output return test and the creep test were performed before resetting the temperature chamber to the next test temperature.

3.2. Minimum Dead Load Output Return Test

This test consisted of the application of a constant maximum test load for 30 minutes at each test temperature. The temperature sequence for this test was 20, 40, -10, and 5 °C. The difference between the load cell output at minimum dead load before the 30 minute application of the test load and the output upon returning to minimum dead load is, by definition, the minimum dead load output return. At each test temperature, the procedure consisted of the following steps:

- a. The load cell was allowed to rest for at least one hour at minimum dead load after completion of a load cycle test at the same test temperature.
- b. The readout instrumentation was checked and the minimum dead load output was monitored until stable.
- c. At minimum dead load, the load cell output, the test temperature, and the barometric pressure were recorded.
- d. The maximum test load was applied for 30 minutes.
- e. The load was reduced to the minimum dead load and the load cell output, the test temperature, and the barometric pressure were recorded, as nearly as practicable, in accordance with point 7 of OIML IR 60. Then the creep test was performed before resetting the temperature chamber to the next test temperature.

3.3. Creep Test

At each test temperature, a constant maximum test load was applied for 4 hours, in the temperature sequence 20, 40, -10, and 5 °C. The maximum difference between the initial reading of load cell output after application of the maximum test load and any subsequent reading during the 4 hour period under load is, by definition, the creep. At each test temperature the procedure consisted of the following steps:

- a. The load cell was allowed to rest for at least one hour at minimum dead load after completion of a minimum dead load output return test at the same test temperature.
- b. The readout instrumentation was checked and the minimum dead load output was monitored until stable.
- c. The maximum test load was applied and the initial load cell output was recorded, as nearly as practicable, in accordance with point 7 of OIML IR 60.
- d. The load cell output and the corresponding time were recorded periodically throughout the 4-hour test. The test temperature and the barometric pressure were recorded at least hourly during the test.

3.4. Pressure Sensitivity Test

This test, conducted at room temperature, consisted of the application of a range of barometric pressures to the unloaded load cell. The ratio of the resulting change in load cell output to the corresponding change in applied barometric pressure is, by definition, the pressure sensitivity. The procedure consisted of the following steps:

- a. The load cell was inserted into a pressure chamber at atmospheric pressure and at room temperature.
- b. The load cell was connected to a readout instrument that was located outside the pressure chamber.
- c. The readout instrumentation was checked and the load cell output was monitored until stable.
- d. A series of test pressures were applied and the corresponding load cell outputs were recorded. The test was performed over as much of the atmospheric range from 95 kPa to 105 kPa as the pressure chamber and associated equipment would permit.

4. DATA ANALYSIS ALGORITHM

An OIML load cell verification test allows for the determination of six load cell performance characteristics. These are: (1) the combined error due to nonlinearity, hysteresis, and temperature effect on sensitivity; (2) the repeatability error; (3) the temperature effect on minimum dead load output; (4) the minimum dead load output return; (5) the creep; and (6) the pressure sensitivity. The data analyses performed in this intercomparison quantify these six characteristics and compute the critical ratio of each characteristic to the corresponding maximum permissible value of that characteristic.

The test results from the five laboratories were normalized to a common test load unit, to load cell capacity, and to the target test temperatures by using the procedures outlined below.

- a. Comparison Mass Unit - Test loads were recorded in either mass or force units. When loads were recorded in mass units, the reported data were first converted to force units by the use of local gravity, weight density, and estimated air density. Test loads were then converted to a common "comparison mass unit", proportional to the applied force, defined by a single arbitrary set of gravity and density values.
- b. Test Loading Range - In some cases, due to the limitations of the loading machine, the test loading range did not equal the load cell capacity. In the analysis of load cycle test data, the errors were referenced to load cell capacity. Minimum dead load output return and creep test data were normalized by multiplying by the ratio of the load cell capacity to the test loading range.
- c. Test Temperature - In some cases, the measured test temperature departed slightly from the target test temperature. The load cycle test data, other than the 20 °C data, were linearly scaled to the target temperature by using the results from the initial test at 20 °C as the reference. Minimum dead load output return and creep test data were linearly interpolated or extrapolated to the high and low target temperatures.

The following test data were used, in combination with the classification parameters listed below, to quantify the six performance characteristics of a load cell:

- a. Test Load - Any test load, including the minimum test dead load, applied during either a load cycle test, a minimum dead load output return test, or a creep test.
- b. Output - The load cell output at minimum dead load or at any other test load.
- c. Factor - Readout instrument calibration factor used to adjust output reading to a common unit in cases where the readout instrument sensitivity had changed during or between tests.
- d. Test Temperature - The measured temperature that best represents the temperature of the load cell. It may have been the average of two or more temperatures sensed on or near the load cell.
- e. Test Pressure - The measured barometric pressure that best represents the pressure acting on the load cell.
- f. Gravimetric Data - The local gravity constant (g), the density of the test weights (D), and the estimated air density during the test (d).

The following classification parameters were used, in combination with the test data listed above, to quantify the six performance characteristics of a load cell:

- a. Capacity - The load cell capacity in mass units.
- b. Class - The OIML Class of the load cell -- Class C for all load cells in this intercomparison.
- c. Maximum Intervals - The maximum number (n_{\max}) of load cell verification intervals (v) into which the load cell measuring range (capacity) can be divided.
- d. Minimum Interval - The minimum load cell verification interval (v_{\min}) into which the load cell measuring range can be divided.
- e. Target Temperatures - The target test temperatures.
- f. Comparison Gravimetric Constants - A single set of arbitrary values of the gravity constant (g_c), weight density (D_c), and air density (d_c).

4.1. Load Cycle Test

Three load cycle performance characteristics are determined by the load cycle test. These are: (1) the combined error due to non-linearity, hysteresis, and

temperature effect on sensitivity; (2) the repeatability error; and (3) the temperature effect on minimum dead load output.

4.1.1. Combined Error

The combined load cell errors due to non-linearity, hysteresis, and temperature effect on sensitivity were computed relative to the mean load cell response at a load of 75 percent of capacity during the ascending part of the initial three load cycles at 20 °C. If there was no test load at 75 percent of capacity, the reference output was computed by linearly interpolating between the two mean outputs at the nearest test loads above and below 75 percent of capacity.

Using equations 1, 2, and 3 below, the recorded test loads were first converted to kilogram-force (kgf) units, then to common comparison mass units, expressed in kilograms (kg), and then to load cell verification interval (v) units:

$$F = \frac{Mg}{9.80665} (1 - d/D), \quad (1)$$

where F is the test load in kgf; M is the test load in kg; g is the local gravity constant in m/s²; d is the estimated local air density; and D is the density of the test weights.

$$M_c = F \frac{9.80665}{g_c(1 - d_c/D_c)}, \quad (2)$$

where M_c is the test load in comparison mass kg units; F is the test load in kgf; g_c is the arbitrary gravity constant in m/s²; d_c is the arbitrary value of air density; and D_c is the arbitrary value of weight density.

$$\text{NET LOAD, in } v = \frac{\text{NET LOAD, in kg}}{\text{CAPACITY, in kg}} (n_{\max}), \quad (3)$$

where NET LOAD is the test load minus the minimum dead load; CAPACITY is the capacity of the load cell; and n_{max} is the maximum number of load cell verification intervals. The same set of arbitrary constants g_c, d_c, and D_c were used in equation 2 to analyze all of the intercomparison test data from all five participating laboratories.

The load cell output readings were recorded either in millivolts per volt (mV/V) or in arbitrary units. Where the readout instrument sensitivity had changed during or between any of the tests, the output readings were adjusted to a common unit by multiplying each reading by the appropriate instrument calibration factor. The load cell output at minimum dead load, at the beginning of each load cycle, was subtracted from the output at each test load of that cycle to obtain the net load cell output. The net load cell output was converted to load cell verification intervals (v) by multiplying the output by the verification interval-output ratio (R) defined by equation 4.

$$R = \frac{0.75 \eta_{\max}}{\text{Interpolated Net Mean Output at 0.75 Capacity}} \quad (4)$$

With both the net test loads and the net mean outputs expressed in verification intervals (v), the combined error y, in v units, at each test load was computed by the use of equation 5.

$$y = (\text{NET OUTPUT, in } v) - (\text{NET LOAD, in } v) \quad (5)$$

The combined errors were normalized from the actual test temperature to the corresponding target temperature by linear interpolation, using the mean errors from the three initial loading cycles at approximately 20 °C as the reference data. The combined errors were interpolated (or extrapolated) to the target temperature by using equation 6.

$$y_i = y_r - \frac{(t_r - t_i)}{(t_r - t_t)} (y_r - y_t), \quad (6)$$

where y_i is the combined error normalized to the target temperature; y_r is the mean combined error during the initial cycles at the reference temperature; y_t is the combined error at the test temperature; t_i is the target temperature; t_r is the actual temperature during the initial cycles at the reference temperature; and t_t is the test temperature.

An example of a plot of the mean combined errors due to nonlinearity, hysteresis, and temperature effect on sensitivity is given in Fig. 1. Each plotted point represents the mean of the errors during three loading cycles at a particular temperature, normalized to the corresponding target temperature. Note that test loads do not coincide with the steps in the error bounds (at 500v and 2000v) and with load cell capacity (η_{\max}). To compensate for this, estimates of the errors that might have occurred at these load levels were computed by linearly interpolating (or extrapolating if necessary at η_{\max}) between the mean errors resulting from adjacent test loads. Each of these interpolated error estimates, along with each of the mean errors, was compared with the maximum permissible error at the corresponding load level. The maximum ratio of either type of error (absolute value) to the corresponding maximum permissible error was dubbed the critical mean combined error ratio.

4.1.2. Repeatability Error

The repeatability error is defined as the maximum difference between the three net load cell outputs at a particular test load during the three loading cycles at a particular temperature. The repeatability error was computed, for each test load and temperature, as the absolute value of the maximum algebraic difference between the three errors computed by equation 6 above. Each of these repeatability errors was divided by the maximum permissible error at the corresponding load level and the maximum ratio obtained was dubbed the critical repeatability error ratio.

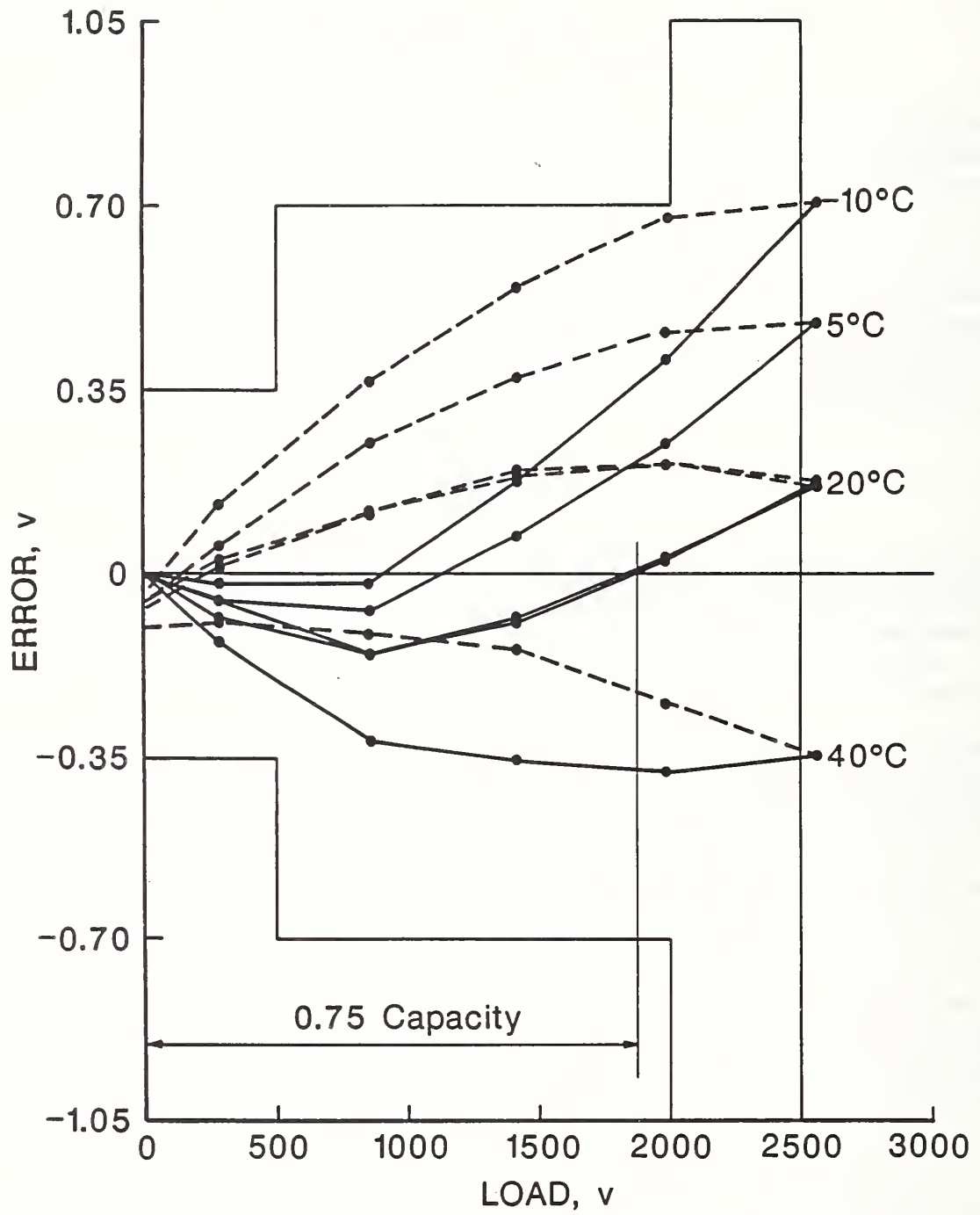

FIGURE 1. Mean combined error during a test of the 200 kg load cell.

4.1.3. Temperature Effect on Minimum Dead Load Output

OIML IR60 specifies that the minimum dead load output shall not vary by more than 0.7 of the minimum load cell verification interval (v_{\min}) for any change of stable load cell temperature of 5 °C. This temperature effect was computed by comparing the minimum dead load outputs at successive test temperatures, after correcting for pressure effects on the outputs. For each test temperature and for the initial minimum dead load of each of the three loading cycles, the following three quantities were computed: (1) the mean minimum dead load output, (2) the mean test temperature, and (3) the mean test pressure. The mean test pressure for the initial load cycle test at 20 °C was used as the reference pressure. The mean minimum dead load outputs for the other test temperatures were corrected for pressure effects by using equation 7.

$$\text{Corrected Output} = \text{Output} - S_p(p_t - p_r), \quad (7)$$

where S_p is the pressure sensitivity of the load cell; p_t is the mean test pressure; and p_r is the reference pressure.

For each successive pair of test temperatures, the difference between the pressure-corrected mean minimum dead load outputs, the difference between the mean test temperatures, and the ratio of the output difference to the temperature difference were computed. The maximum computed ratio was selected, multiplied by 5, and multiplied by the ratio R from equation 4 to obtain the temperature effect on minimum dead load output in verification intervals per 5 °C. This temperature effect was divided by 0.7 (v_{\min}), where v_{\min} was expressed in units of the verification interval v , to obtain the critical ratio of the temperature effect on minimum dead load output.

4.2. Minimum Dead Load Output Return Test

The analysis of data from the minimum dead load output return test involved the following steps:

- a. The net test load was converted to comparison mass units by the use of equations 1 and 2.
- b. The load cell output readings were adjusted to a common unit by multiplying each reading by the appropriate instrument calibration factor, as necessary.
- c. For each test temperature, the difference between the load cell outputs before and after the 30 minute load application was computed by subtracting the initial reference output from the corresponding pressure-corrected return output. The return output was corrected for pressure effect by the use of equation 7. The reference pressure was the pressure recorded at minimum dead load before the 30 minute load application.
- d. The differences computed in step c were normalized to load cell capacity by multiplying each by the ratio of capacity to net test load.

- e. The normalized differences computed in step d were converted to verification interval (v) units by multiplying each by the ratio R in equation 4.
- f. Estimated differences, corresponding with the extreme high and low target temperatures, were linearly interpolated (or extrapolated), relative to the differences computed in step e. The 40 °C value was interpolated relative to the test results at approximately 20 and 40 °C. The -10 °C value was interpolated relative to the test results at approximately -10 and 5 °C.
- g. The maximum absolute value was selected from the differences computed in step e and the estimated differences interpolated in step f. This maximum absolute value was taken to be the minimum dead load output return characteristic of the load cell. This result was divided by 0.5v to obtain the critical minimum dead load output return ratio.

4.3. Creep Test

The analysis of data from the creep test involved the following steps:

- a. The net creep test load was converted to comparison mass units by the use of equations 1 and 2.
- b. The load cell output readings were adjusted to a common unit by multiplying each reading by the appropriate instrument calibration factor, as necessary.
- c. For each test temperature, the differences between the initial reference load cell output and all outputs recorded during the subsequent 4 hours of the creep test were computed by subtracting the initial reference output from the pressure-corrected subsequent outputs. The subsequent outputs were corrected for pressure effects by the use of equation 7. The reference pressure was the pressure recorded at the time of the reference output reading. For each test temperature, the maximum absolute value of the differences was selected, but the algebraic sign of that difference was retained.
- d. The maximum differences computed in step c were normalized to load cell capacity by multiplying each by the ratio of capacity to net creep test load.
- e. The normalized differences computed in step d were converted to verification interval (v) units by multiplying each by the ratio R in equation 4.
- f. Estimated differences, corresponding to the extreme high and low target temperatures, were linearly interpolated (or extrapolated), relative to the maximum differences computed in step e. The 40 °C value was interpolated relative to the test results at approximately

20 and 40 °C. The -10 °C value was interpolated relative to the test results at approximately -10 and 5 °C.

- g. The maximum absolute value was selected from the differences computed in step e and the estimated differences interpolated in step f. This maximum absolute value was taken to be the creep characteristic of the load cell. This result was divided by 1.5 times the maximum permissible error at capacity load, expressed in units of the verification interval v , to obtain the critical creep ratio.

4.4 Pressure Sensitivity Test

The analysis of data from the pressure sensitivity test involved the following steps:

- a. The recorded test pressures were converted to kilopascal (kPa) units.
- b. The load cell output readings were adjusted to a common unit by multiplying each reading by the appropriate instrument calibration factor, as necessary.
- c. A straight line was fitted to the output versus pressure data. The slope of the line is the pressure sensitivity, in common output units, per kPa.
- e. The pressure sensitivity was converted to verification intervals (v) per kPa by multiplying by the ratio R in equation 4. This pressure sensitivity was divided by v_{\min} , where v_{\min} was expressed in units of the verification interval v , to obtain the critical pressure sensitivity ratio.

5. TEST RESULTS

In the analysis of the test results from all five laboratories, the following constraints were placed on the classification parameters:

- a. All the results for a particular load cell were analyzed for the same maximum number of verification intervals and the value of n_{\max} was restricted to be a multiple of 500.
- b. In all cases, the value of the minimum load cell verification interval (v_{\min}) was set equal to the load cell verification interval (v).
- c. All test loads were converted to common "comparison mass units" that were determined by the following comparison gravimetric constants: $g_c = 9.801 \text{ m/s}^2$, $d_c = 0.0012 \text{ g/cm}^3$, $D_c = 8.0 \text{ g/cm}^3$.

The test results obtained by the five participating laboratories from tests of the six load cells are summarized in Tables 1 through 6. Each table gives the test results for one load cell. Within a table, each numbered column gives the test results from one laboratory. Each row, except the bottom row, gives the critical ratio of a measured characteristic to the limiting value of that characteristic. The bottom row gives the largest value of the characteristic critical ratios. The two rightmost columns give the mean values and the estimated standard deviations of the characteristic critical ratios that are not underlined. The critical ratios that are underlined have been excluded from the computation of the mean and standard deviation because of some limitation in test conditions or procedures, as explained in footnotes below the tables. Two laboratories did not test the 1500 kg load cell and did not perform some of the tests on some of the other load cells; these cases are indicated by dashed lines in Tables 1 through 6. Pressure sensitivity tests were performed only on the 20000 kg and 25000 kg canister load cells.

The magnitudes of the characteristic critical ratios given in Tables 1 through 6 depend on the particular maximum number of verification intervals (n_{\max}) for which the test data are analyzed. However, the relative magnitudes would be roughly the same for other values of n_{\max} , although there would be some differences depending on the relationships of test loads to steps in the error bounds.

The classification of each load cell would be limited by the characteristic maximum critical ratio, the result given in the bottom row of Tables 1 through 6. These results from the 28 tests indicate that the load cell classification would be limited in 13 cases by the minimum dead load output return, in 10 cases by the mean combined error, in 3 cases by the repeatability error, and in 2 cases by the temperature effect on minimum dead load output. Table 7 gives the maximum number of verification intervals for which the four larger-capacity load cells would qualify, based on a direct application of these numerical results. The two smaller-capacity load cells are not included in Table 7 because of differences between some of the measured characteristics that make direct comparisons based on the maximum critical ratio not meaningful.

In evaluating these results, it is useful to compare the separate characteristic critical ratios as well as the maximum critical ratios. The mean and standard deviation values are useful references when making these comparisons. With a few exceptions, there is reasonably good agreement in the measurement of the separate characteristics of the six load cells. In the cases where a measured characteristic appears to be inconsistent with the results from other laboratories, the laboratory that performed the test can consider the particular case and make appropriate refinements in its measurement process.

Specific points concerning the results of the tests of each of the six load cells, as presented in Tables 1 through 6, are given in Sections 5.1. through 5.6.

TABLE 1. CHARACTERISTIC CRITICAL RATIO -- 25000 kg LOAD CELL
ANALYZED FOR 3000v

CHARACTERISTIC	LABORATORY					MEAN	STRD. DEV.
	1	2	3	4	5		
Mean combined error	0.92	0.72	0.69	0.66	0.78	0.75	0.10
Repeatability error	0.18	0.28	0.16	0.17	0.31	N/A	N/A
Temp. effect on min. output	0.08	0.13	0.19	<u>0.20</u> ¹	0.15	0.14	0.05
Min. output return	0.63	0.71	0.86	0.91	0.84	0.79	0.12
Creep	-----	0.44	0.48	0.59	0.39	0.48	0.09
Pressure sensitivity	-----	-----	0.03	0.03	0.03	0.03	0.00
Max. critical ratio	0.92	0.72	0.86	0.91	0.84	N/A	N/A

¹Not included in computation of mean. Computed from outputs before and after temperature steps rather than from outputs during load cycle tests.

TABLE 2. CHARACTERISTIC CRITICAL RATIO -- 20000 kg LOAD CELL
ANALYZED FOR 3500v

CHARACTERISTIC	LABORATORY					MEAN	STRD. DEV.
	1	2	3	4	5		
Mean combined error	0.72	0.77	0.60	<u>0.41</u> ¹	1.06	0.79	0.20
Repeatability error	0.64	0.39	0.10	<u>0.25</u> ¹	0.45	N/A	N/A
Temp. effect on min. output	0.13	0.15	0.14	<u>0.19</u> ²	0.15	0.14	0.01
Min. output return	0.71	0.88	0.89	0.81	0.84	0.83	0.07
Creep	-----	0.43	0.47	0.44	0.51	0.46	0.04
Pressure sensitivity	-----	0.10	0.10	0.10	0.10	0.10	0.00
Max. critical ratio	0.72	0.88	0.89	0.81	1.06	N/A	N/A

¹Not included in computation of mean. Only 4 test loads applied.

²Not included in computation of mean. Computed from outputs before and after temperature steps rather than from outputs during load cycle tests.

TABLE 3. CHARACTERISTIC CRITICAL RATIO -- 1500 kg LOAD CELL
ANALYZED FOR 2500v

CHARACTERISTIC	LABORATORY					MEAN	STRD. DEV.
	1	2	3	4	5		
Mean combined error	-----	-----	0.57	0.85	<u>0.96</u> ¹	N/A	N/A
Repeatability error	-----	-----	0.16	0.21	<u>0.24</u> ¹	N/A	N/A
Temp. effect on min. output	-----	-----	0.30	<u>0.26</u> ²	0.20	N/A	N/A
Min. output return	-----	-----	1.00	0.63	0.43	0.69	0.29
Creep	-----	-----	0.65	0.58	0.40	0.54	0.13
Max. critical ratio	-----	-----	1.00	0.85	0.96	N/A	N/A

¹Not included in computation of mean. Only 4 test loads applied.

²Not included in computation of mean. Computed from outputs before and after temperature steps rather than from outputs during load cycle tests.

TABLE 4. CHARACTERISTIC CRITICAL RATIO -- 500 kg LOAD CELL
ANALYZED FOR 3500v

CHARACTERISTIC	LABORATORY					MEAN	STRD. DEV.
	1	2	3	4	5		
Mean combined error	0.74	0.60	0.67	0.77	0.86	0.73	0.10
Repeatability error	1.10	0.12	0.35	0.70	0.45	N/A	N/A
Temp. effect on min. output	0.38	1.01	0.63	<u>0.65</u> ¹	0.65	0.67	0.26
Min. output return	1.33	0.83	0.89	0.91	0.70	0.93	0.24
Creep	-----	0.42	0.45	0.40	0.32	0.40	0.06
Max. critical ratio	1.33	1.01	0.89	0.91	0.86	N/A	N/A

¹Not included in computation of mean. Computed from outputs before and after temperature steps rather than from outputs during load cycle tests.

TABLE 5. CHARACTERISTIC CRITICAL RATIO -- 200 kg LOAD CELL
ANALYZED FOR 2500v

CHARACTERISTIC	LABORATORY					MEAN	STRD. DEV.
	1	2	3	4	5		
Mean combined error	1.18	<u>1.27</u> ¹	0.96	0.60	<u>0.99</u> ²	0.91	0.29
Repeatability error	0.29	<u>0.73</u> ¹	0.25	0.61	<u>0.82</u> ²	N/A	N/A
Temp. effect on min. output	0.18	0.30	0.45	<u>0.21</u> ³	0.39	0.33	0.12
Min. output return	1.65	0.55	0.44	0.59	1.64	0.97	0.62
Creep	-----	-----	0.17	0.43	0.51	0.37	0.18
Max. critical ratio	1.65	1.27	0.96	0.61	1.64	N/A	N/A

¹Not included in computation of mean. Only 2 load cycles included in initial test at 20 °C.

²Not included in computation of mean. Data from only 2 load cycles included in computations for -10 °C, 5 °C, and 40 °C.

³Not included in computation of mean. Computed from outputs before and after temperature steps rather than from outputs during load cycle tests.

TABLE 6. CHARACTERISTIC CRITICAL RATIO -- 18 kg LOAD CELL
ANALYZED FOR 6000v

CHARACTERISTIC	LABORATORY					MEAN	STRD. DEV.
	1	2	3	4	5		
Mean combined error	0.80	0.90	0.58	1.31	1.31	0.98	0.32
Repeatability error	1.80	0.28	0.62	0.95	1.04	N/A	N/A
Temp. effect on min. output	0.59	0.37	0.53	<u>1.68</u> ¹	0.36	0.46	0.12
Min. output return	-----	0.60	0.49	0.90	1.73	0.93	0.56
Creep	-----	0.34	0.42	0.93	0.76	0.61	0.28
Max. critical ratio	1.80	0.90	0.62	1.68	1.73	N/A	N/A

¹Not included in computation of mean. Computed from outputs before and after temperature steps rather than from outputs during load cycle tests.

TABLE 7. MAXIMUM NUMBER OF VERIFICATION INTERVALS

CAPACITY kg	LABORATORY				
	1	2	3	4	5
25000	3000	4000	3000	3000	3500
20000	4500	3500	3500	4000	3000
1500	----	----	2500	2500	2500
500	2500	3000	3500	3500	4000

5.1. 25000 kg Load Cell

- a. The maximum number of load cell intervals (n_{\max}) would be limited by the mean combined error in two cases and by the minimum dead load output return in three cases.
- b. The pressure sensitivity of the load cell is lower than the temperature effect on minimum dead load output. Therefore, the minimum load cell verification interval (v_{\min}) would be limited by the temperature effect on minimum dead load output. The results from the five laboratories correspond to values of v_{\min} ranging from 8 to 20 percent of the load cell verification interval v (for $3000v$).²

5.2. 20000 kg Load Cell

- a. The n_{\max} would be limited by the mean combined error in two cases and by the minimum dead load output return in three cases.
- b. The pressure sensitivity of the load cell is lower than the temperature effect on minimum dead load output. Therefore, the minimum load cell verification interval (v_{\min}) would be limited by the temperature effect on minimum dead load output. The results from the five laboratories correspond to values of v_{\min} ranging from 13 to 19 percent of the load cell verification interval v (for $3500v$).²

²In computing the error ratios for the temperature effect on minimum dead load output, the value of v_{\min} was arbitrarily set equal to v . Therefore, the tabulated error ratios are the ratios of the minimum value of v_{\min} for which the load cell could be classified to the verification interval v used in the data analysis.

5.3. 1500 kg Load Cell

- a. The n_{\max} would be limited by the mean combined error in two cases and by the minimum dead load output return in one case.
- b. The results from the three laboratories correspond to values of v_{\min} ranging from 20 to 30 percent of the load cell verification interval v (for 2500v).²

5.4. 500 kg Load Cell

- a. The n_{\max} would be limited by the mean combined error in one case, by the temperature effect on minimum dead load output in one case, and by the minimum dead load output return in three cases.
- b. The result from Laboratory 2 exceeds the permissible value of the temperature effect on minimum dead load output by one percent (for 3500v). The results from the other four laboratories correspond to values of v_{\min} ranging from 38 to 65 percent of the load cell verification interval v (for 3500v).²
- c. The repeatability error from Laboratory 1 would not exceed the limit for 3000v.
- d. The minimum dead load output return from Laboratory 1 would exceed the limit for 3000v by only 3 counts in 100000.

5.5. 200 kg Load Cell

- a. The n_{\max} would be limited by the mean combined error in two cases, by the repeatability error in one case, and by the minimum dead load output return in two cases.
- b. The results from the five laboratories correspond to values of v_{\min} ranging from 18 to 45 percent of the load cell verification interval v (for 2500v).²
- c. The mean combined error from Laboratory 2 exceeds the limit for 2500v in only one reading at -10 °C.
- d. The minimum dead load output return results from Laboratories 1 and 5 were both obtained at 40 °C and they are in good agreement, whereas the results from the other three laboratories were obtained at either -10 °C or 5 °C. However, the results from Laboratories 1 and 5 appear to be high in relation to the creep results from the three laboratories that performed the creep test.

5.6. 18 kg Load Cell

- a. The n_{\max} would be limited by the mean combined error in one case, by the repeatability error in two cases, by the temperature effect on

minimum dead load output in one case, and by the minimum dead load output return in one case.

- b. The result from Laboratory 4 exceeds the permissible value of the temperature effect on minimum dead load output by 68 percent (for 6000v). The results from the other four laboratories correspond to values of v_{\min} ranging from 36 to 59 percent of the load cell verification interval v (for 6000v).²
- c. Although several of these results exceed the permissible values for 6000v, they would all be well within the limits for 3000v.

6. PIVOT LABORATORY REPORTS

The first laboratory that tested each load cell was designated the pivot laboratory for that load cell. Each pivot laboratory performed the following three special tasks:

- a. Retest - After the load cell had been tested by all laboratories, it was returned to the pivot laboratory for additional measurements to determine whether or not it had remained stable throughout the testing program. The scope of these additional measurements was decided by the pivot laboratory.
- b. Data Analysis - Each laboratory submitted its test data for a particular load cell to the pivot laboratory responsible for that load cell. The pivot laboratory analyzed these data using its own algorithm, which did not necessarily include normalization for load and temperature as described in section 4 of this report.
- c. Report - The pivot laboratory prepared a summary report covering its retest of the load cell and its analysis of the test data from all laboratories by its own algorithm.

The reports prepared by the five pivot laboratories are appended to this report as Appendices A through E. A brief summary of the pivot laboratory report on each of the six load cells follows.

6.1. 25000 kg Load Cell

A load cycle test at 20.7 °C was performed after the load cell had been tested by the other laboratories. These results indicate that the load cell remained sufficiently stable throughout the testing program. The pivot laboratory analysis of the test data from the five laboratories gave maximum numbers of verification intervals of from 3000v to 4000v, which is in agreement with Table 7.

6.2. 20000 kg Load Cell

The complete verification test was repeated, except for the pressure sensitivity test, after the load cell had been tested by the other laboratories. These results indicate that the load cell remained sufficiently

stable throughout the testing program. The pivot laboratory analysis of the test data from the five laboratories gave maximum numbers of verification intervals of from 2500v to 4000v, which is 500v lower than the range given in Table 7.

6.3. 1500 kg Load Cell

The results of load cycle tests at approximately 20 °C, both before and after the load cell was tested by the other laboratories, indicate that the load cell remained sufficiently stable throughout the testing program. The pivot laboratory analysis of the test data from the three laboratories that tested this load cell is not in a form that permits a direct comparison with the results given in Table 7.

6.4. 500 kg Load Cell

Zero-load output and full-scale output at room temperature were measured both before and after the load cell was tested by the other laboratories. These results indicate that the load cell remained sufficiently stable throughout the testing program. The pivot laboratory analysis of the test data from the five laboratories gave maximum numbers of verification intervals of from 2500v to 4000v. However, most of the data from all five laboratories is consistent with a classification of 3500v. And, except for differences of only a few counts in several output readings, all five laboratories could have classified the load cell for 3500v.

6.5. 200 kg Load Cell

The complete load cycle test was repeated after the load cell had been tested by the other laboratories. These results indicate that the load cell remained sufficiently stable throughout the testing program. The pivot laboratory analysis of the test data from the five laboratories gave maximum numbers of verification intervals of from 1500v to 4500v, which correlates with the range of the maximum critical ratios given in Table 5.

6.6. 18 kg Load Cell

The complete load cycle test was repeated after the load cell had been tested by the other laboratories. These results indicate that the load cell remained sufficiently stable throughout the testing program. The pivot laboratory analysis of the test data from the five laboratories gave maximum numbers of verification intervals of from 3000v to 9000v, which correlates with the range of the maximum critical ratios given in Table 6.

7. CONCLUSIONS

The test results support the following conclusions:

- a. The six load cells remained sufficiently stable throughout the testing program.
- b. Overall, there is reasonably good agreement among the five laboratories in the measurement of most of the characteristics of the six load cells (see Tables 1 through 6). The agreement is generally better for the four larger-capacity load cells than for the two smaller-capacity ones.
- c. The between-laboratory differences in the maximum number of verification intervals of the four larger-capacity load cells range from 0v to 1500v (see Table 7). The between-laboratory differences in the maximum number of verification intervals of the two smaller-capacity load cells are not meaningful because of the variations in some of the measured characteristics of these load cells (see Tables 5 and 6).
- d. Of the 28 load cell verification tests that were performed, the load cell classification (n_{\max}) was limited by the minimum dead load output return in 13 cases and by the mean combined error in 10 cases (see Tables 1 through 6). This is an indication of the relative importance of the measurement of these two characteristics in determining the classification of a load cell.
- e. The test results from all five participating laboratories would qualify the 25000 kg, the 20000 kg, and the 18 kg load cells for at least 3000v.
- f. The test results from four of the five participating laboratories would qualify the 500 kg load cell for at least 3000v. The results from the fifth laboratory would qualify this load cell for 3000v, except for a single minimum dead load output return reading that exceeded the permissible value by only 3 counts in 100000.
- g. The test results from the three laboratories that tested the 1500 kg load cell would qualify that load cell for 2500v.
- h. Most of the test results for the 200 kg load cell would be consistent with a classification of at least 2000v.
- i. Assuming that the appropriate refinements in the measurement processes will be made, the results reported here provide the rationale for the exchange of test data between national laboratories for purposes of load cell classification for at least 3000v.

APPENDIX A
PIVOT LABORATORY REPORT
25000 kg LOAD CELL

Report of an international intercomparison of a load cell test

1. Introduction

During the period 1985-1987 five national metrological laboratories have carried out an intercomparison program on pattern approval examinations of load cells.

This report evaluates the results of one of the load cells used in the program.

A 25000 kg canister compression type load cell, made in the Netherlands, was tested by five national metrological laboratories at the following dates:

- Dienst van het IJkwezen (dept. weighing technology (WT)), the Netherlands, during the period February 1986;
- Physikalisch-Technische Bundesanstalt (PTB), Federal Republic of Germany, during the period March 1986;
- National Bureau of Standards (NBS), United States of America, during the period June 1986;
- National Standards Commission (NSC), Australia, during the period February 1987;
- National Weights and Measures Laboratory (NWML), United Kingdom, during the period September 1987.
The tests however, were carried out under supervision of NWML at W & T Avery Ltd. at Tamebridge;
- Retest at the Dienst van het IJkwezen (WT), the Netherlands, during the period January 1988.

The retest at WT in January 1988 did not include the temperature test or the creep test, but a linearity and hysteresis test at room temperature.

The identification of the laboratories in this report is the same as on the meeting in Teddington, May 1988.

Summarized Conclusion

Although the load cell is of a type which does not need any special precautions to carry out the pattern approval tests, the overall conclusion of the five national metrological laboratories is not the same. Three laboratories would approve the load cell for 3500 scale intervals. One laboratory would give a pattern approval for 3000 scale intervals and the fifth laboratory would give a pattern approval for 4000 scale intervals. The values for the minimum verification scale interval lies closer to each other, with one exception. This extreme high value however, should always ask for a retest.

3. The equipment

3.1 The load cell

A canister compression type load cell with a capacity of 25000 kg was supplied by a Dutch manufacturer for the intercomparison program. The load cell (4-wire system) was supplied without a connector or loading equipment to the national metrological laboratories. The overall dimensions of the load cell are shown in figure below.

A = ϕ 72 mm
B = 83 mm
C = 33 mm
D = 150 mm
E = 61 mm
F = 10 mm

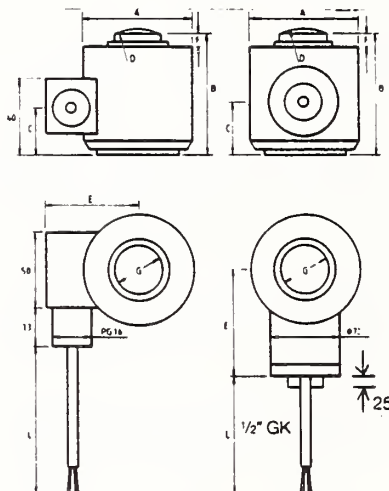

3.2 The indicators

Because in 1985 no appointments were made about the indicator to be used, each laboratory used their own indicator for the examinations.

The following indicators are used:

WT : manufacture : Servo-balans
type : 380
voltage : 10 V DC

PTB : manufacture : HBM
type : DMP-39 S6
voltage : 10 V AC
frequency : 225 Hz

NBS : manufacture : Gilmore/DJ-instruments
type : 354/101-C
voltage : 10 V DC

NSC : manufacture : Toledo
type : 8132
voltage : 10 V DC (gated)
frequency : 225 Hz

NWML: manufacture : Datron D.V.M./Power design
type : 1071/2010
voltage : 15 V DC

3.3 The standard machines

Because the type of standard machine may have influence on the test results it would be advisable to draw up an inventory of the machines used for the examination. The several reports however do not describe in detail the machines which are used. For instance, WT used for the temperature test a lever type testing machine with 2500 kg deadweight. For the 1/2 hour creep however, a hydraulic testing machine is used because the semi-deadweight standard machine can not remove the weights as quickly as necessary. The deadload of WT was in the first test about 2000 kg (8 %). At the retest in 1988 however the deadload was reduced to 200 kg. The PTB used for their testing the 1 MN deadweight standard machine with a relative small deadload (about 0,1 %) on the load cell. NBS used for their testing the 112 klf deadweight standard machine with a deadload of 3 klf (about 5 %) on the load cell. The Australian colleagues (NSC) used their 50 tons testing machine which also has a lever system. The deadload on the load cell was 1.6 ton (6.5 %). NWML tested the load cell on the deadweight machine from W & T Avery Ltd. which has a capacity of 55 tons and a deadload of about 10 kg (0,05 %). There are several points which are important to know which testing machine has been used for the tests. One of those points is that from a theoretical point of view a deadweight standard machine may have a higher accuracy than a lever-type machine. Another point is that the deadload of some machines is so high that characteristics in the lower area of the measuring range can not be identified.

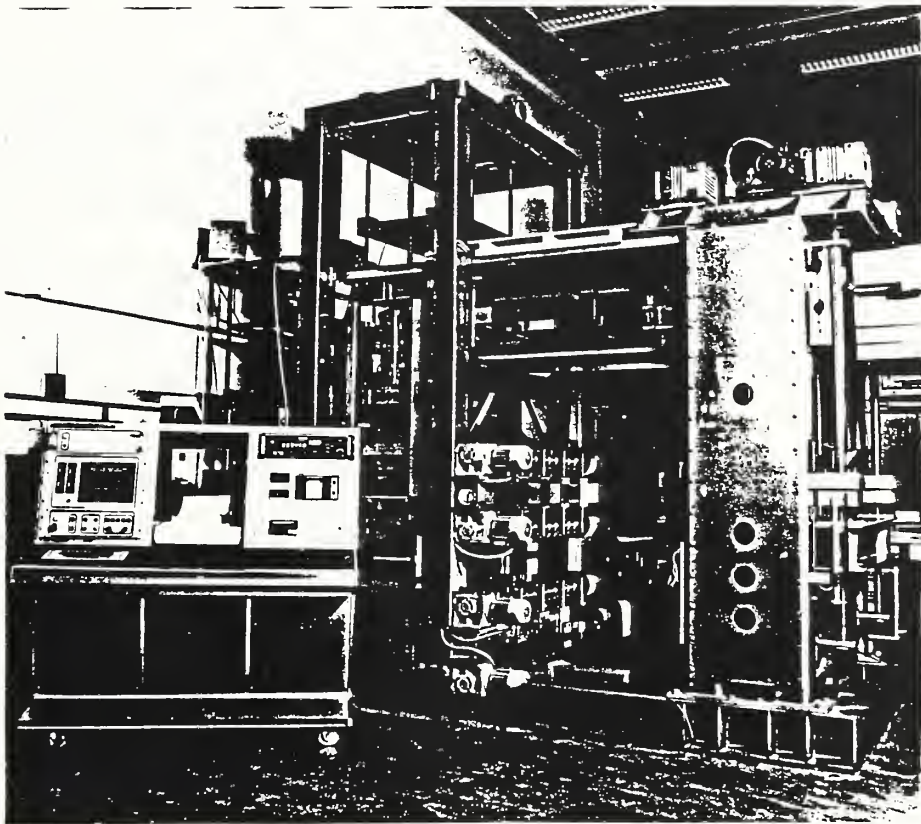

4. Testresults

All data which were received from the several metrological laboratories have been evaluated in the way as usual in the Netherlands i.e. per item and related to IR 60. The following conclusions are made:

4.1. Non-linearity

Non-linearity is defined as the deviation of the increasing load cell output from a straight line. During the pattern approval tests the non-linearity is tested at several temperatures between - 10 °C and + 40 °C. Normally the following cycle is used: 20, 40, (20,) -10, +5 and 20 °C. The average load cell output at increasing and decreasing load is plotted in the diagrams (see fig. 2 - 7).

As follows from the graphs it is obvious that the maximum number, of verification scale intervals is limited by the characteristics of the load cell at maximum capacity. Three laboratories found 3500 scale intervals as the maximum amount of scale intervals, laboratory 2 found 4000 scale intervals and laboratory 4 found 5000 scale intervals. A second characteristic of the load cell, namely a bend in the curve at a capacity of approximately 10 %, was only found by the laboratories 2 and 5. This is caused by the low deadload and increments of 2000 or 2500 kg used by these laboratories. All laboratories found that the temperature compensation of the load cell was in the way that the high temperature curve laid under the room temperature and the low temperature curve was above the room temperature curve, with one exception (laboratory 5), where all curve were very near to each other.

4.2. Hysteresis

Hysteresis is defined as the difference between load cell output readings for the same applied load; that is, one reading is obtained by increasing loading-steps and the other by decreasing loading-steps.

The results of all the laboratories with respect to hysteresis were very close to each other.

The highest hysteresis appeared in the range from 800 - 2500 v and was for all temperatures approximately the same, except for the high temperature, 4 laboratories found a smaller value. Only laboratory 5 found no smaller value for the high temperature. The overall value for hysteresis can be found in fig.1

4.3. Temperature effect on minimum dead load output.

The temperature effect on minimum dead load output is defined as the change in minimum deadload output due to a change in ambient temperature.

In the Netherlands normally the results given from the readings from the temperature test are laid down in a graph after which a second grade curve is drawn to which all the data points fits as close as possible.

The angle of the tangent per 5 degrees celsius is an indication for the minimum verification scale interval (v(min)). Laboratory 1 found a very high value for v(min): N/65000. Laboratory 3, 4 and 5 found values which were very close together: N/17000 and N/14000. Laboratory 2 found a somewhat larger value N/25000. This last value was found during the temperature change from + 40 °C to - 10 °C. The time between these two readings took 3 days. This could effect the found value.

4.4. Temperature effect on sensitivity

The temperature effect on sensitivity is defined as the change in sensitivity due to a change in ambient temperature. The data received from the laboratories have been evaluated and the results for the various temperatures are plotted in the figures 2 - 7.

The figures show that the laboratories 1, 3 and 4 found a dispersion of less than 0.4 v between all temperatures. Laboratories 2 and 5 however found a dispersion of 1 v and 0.8 v.

4.5. Minimum deadload output return (1/2 hr. creep)

With the minimum deadload output return test the difference between the initial reading after returning to the minimum deadload and the reading prior to the application of a load of approximately 100 % of the capacity which has been applied on the load cell for 30 minutes can be found. The results of this however can heavily be effected by the speed in the which the load cell can be unloaded. For example laboratory 1 could unload the load cell within 3 seconds. Laboratory 3 needed 90 seconds to unload the load cell. In the results however this expected effect of the different unloading-speeds was not found.

As result of this test two laboratories found 4000 scale intervals, two other laboratories found 3500 scale intervals and the laboratory with the 90 seconds time-interval found 3000 scale intervals.

Laboratory 1 carried the test only at 20 °C, 40 °C and - 10 °C out and not at 5 °C.

4.6 Creep at maximum capacity

The creep at maximum capacity is defined as the difference between the initial reading and any reading during the test when a load of 90 - 100 % of the maximum capacity has been placed on the load cell during a period of four hours.

The maximum scale intervals which were found by the laboratories were estimated at different temperatures. For example laboratory 2 found a maximum number of scale divisions of 6000 at 40 °C. Laboratory 4 however found a maximum number of scale divisions of 5000 at a temperature of -10 °C. And laboratory 5 at least found 7000 divisions at a temperature of 5 °C.

4.7. Overall

In figure 1 the results from all the tests are given per laboratory. Per test the lowest value is given. In annex 2 all data and the results per test are evaluated.

	non-linearity	hysteresis	temp. effect on zero	temp. effect on span	1/2 hr creep	4 hour creep	overall results
lab 1	3500	0.25 V_{3500}	$V_{min} = N/65000$	fig. 2	4000 v	-----	3500 v
lab 2	4000	0.4 V_{4000}	$V_{min} = N/25000$	fig. 3	4000 v	6000 v	4000 v
lab 3	3500	0.25 V_{3500}	$V_{min} = N/17000$	fig. 4	3000 v	5000 v	3000 v
lab 4	5000	0.3 V_{3500}	$V_{min} = N/14000$	fig. 5	3500 v	5000 v	3500 v
lab 5	3500	0.3 V_{3500}	$V_{min} = N/14000$	fig. 6	3500 v	7000 v	3500 v

Figure 1: Results

Intercomparison program
for load-cells

Laboratory 1

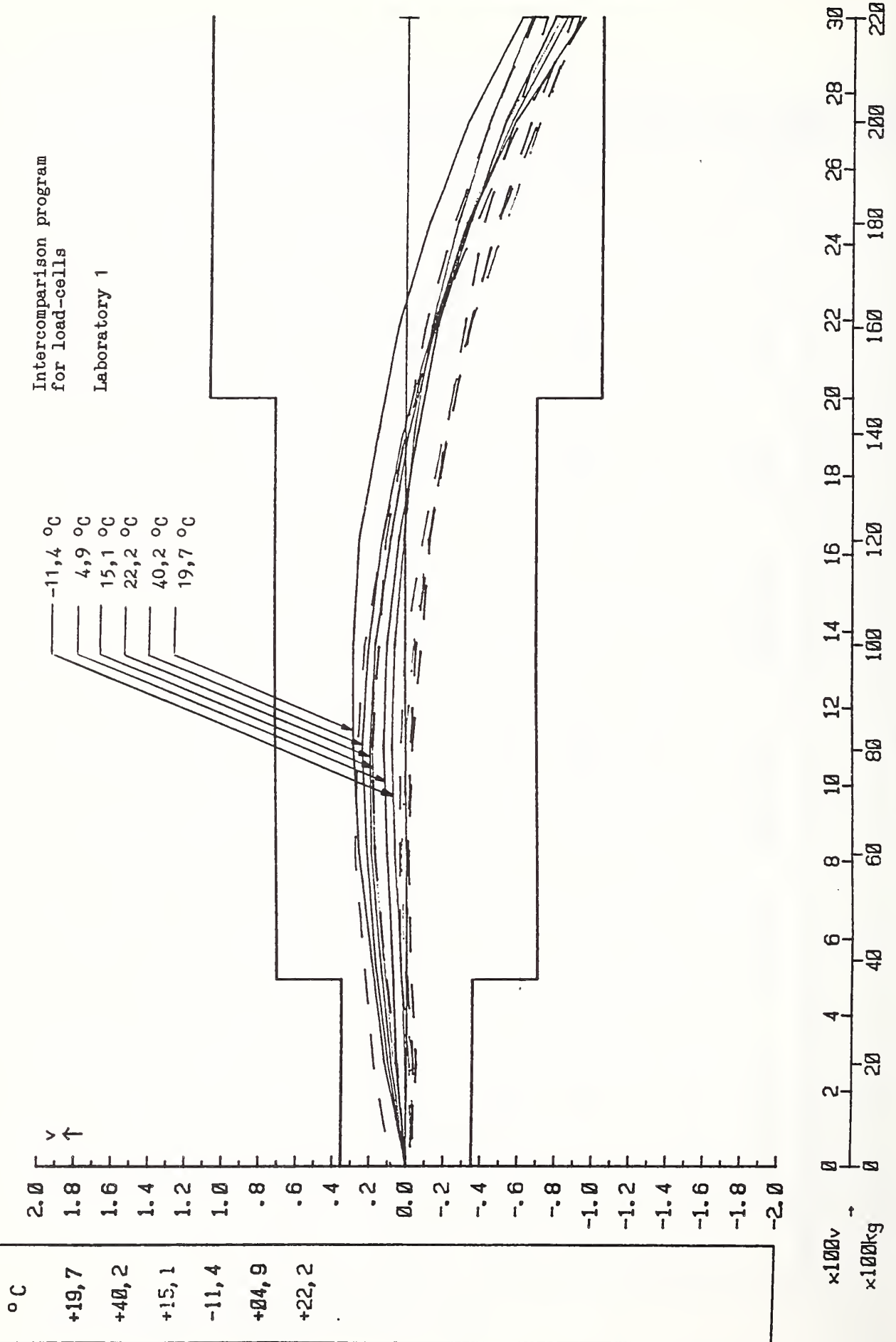

Intercomparison program
for load-cells
Laboratory 2

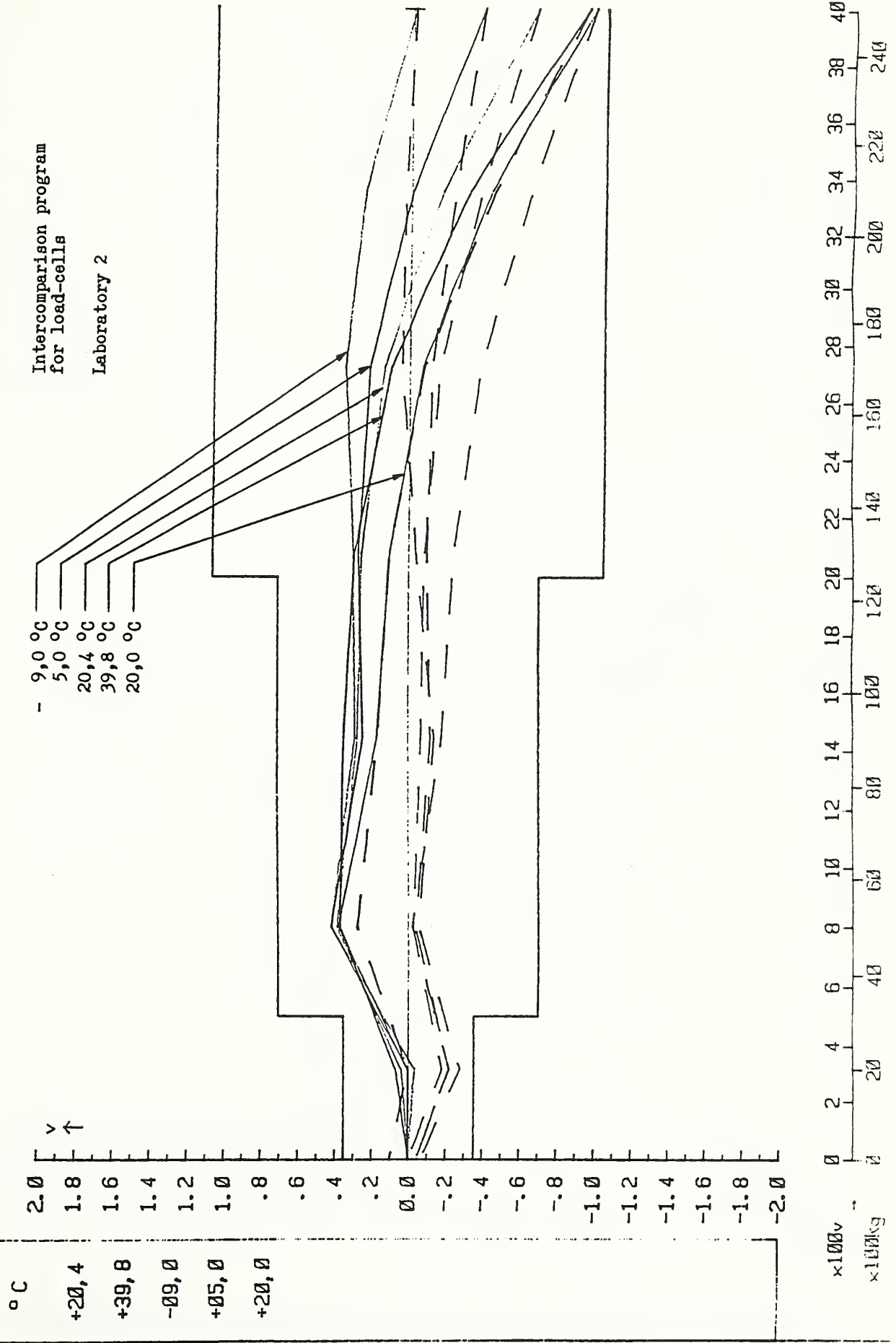

°C
20.4
40.5
-9.4
19.7
4.4
-9.4

Intercomparison program
for load-cells
Laboratory 3

40,5 °C
20,4 °C
19,7 °C
4,4 °C
- 9,4 °C

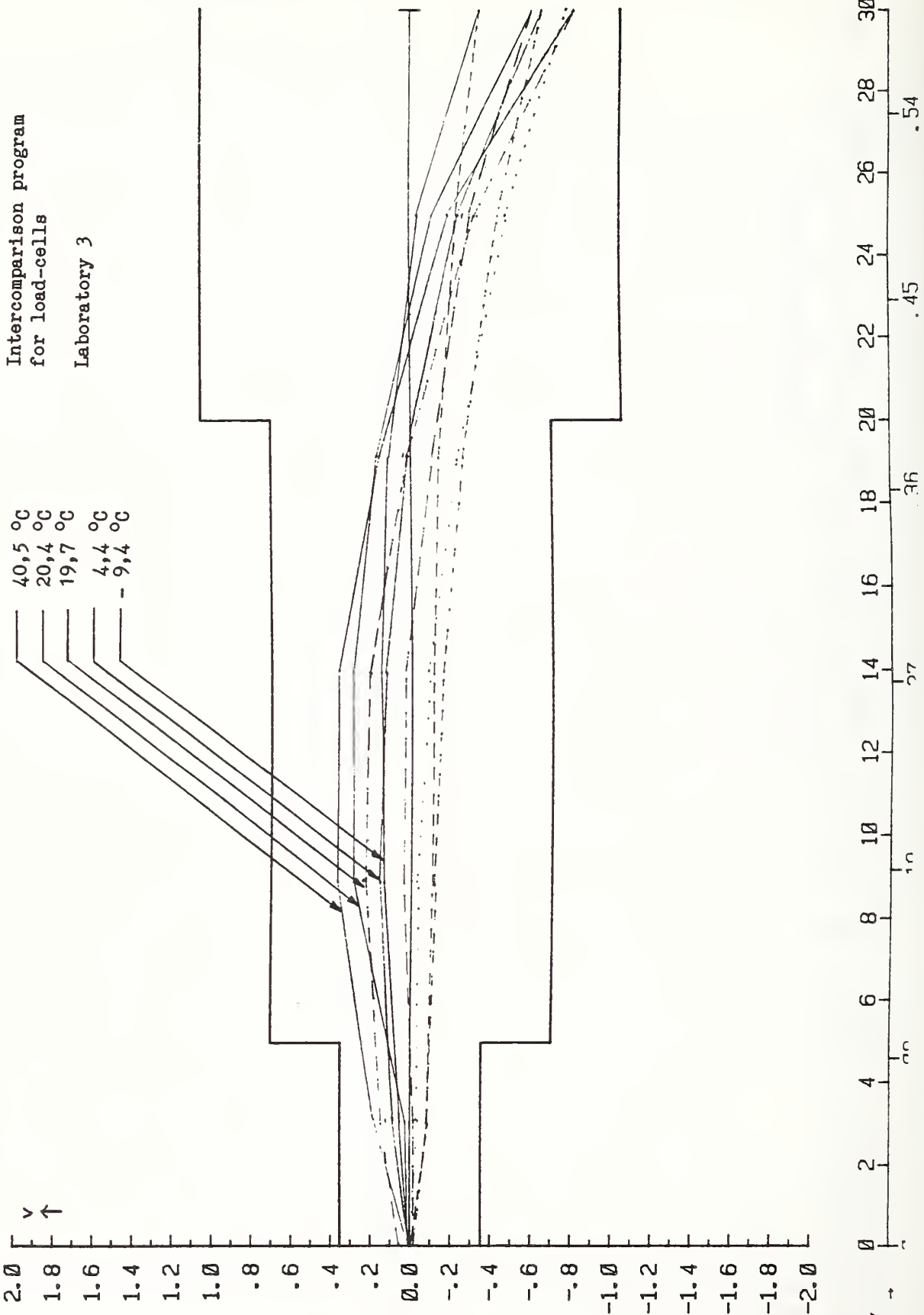

0 2 4 6 8 10 12 14 16 18 20 22 24 26 28 30
x100v
10
27
36
45
54

°C

+21, 2
+39, 2
-24, 3
+05, 4
+18, 0

Intercomparison program
for load-cells
Laboratory 4

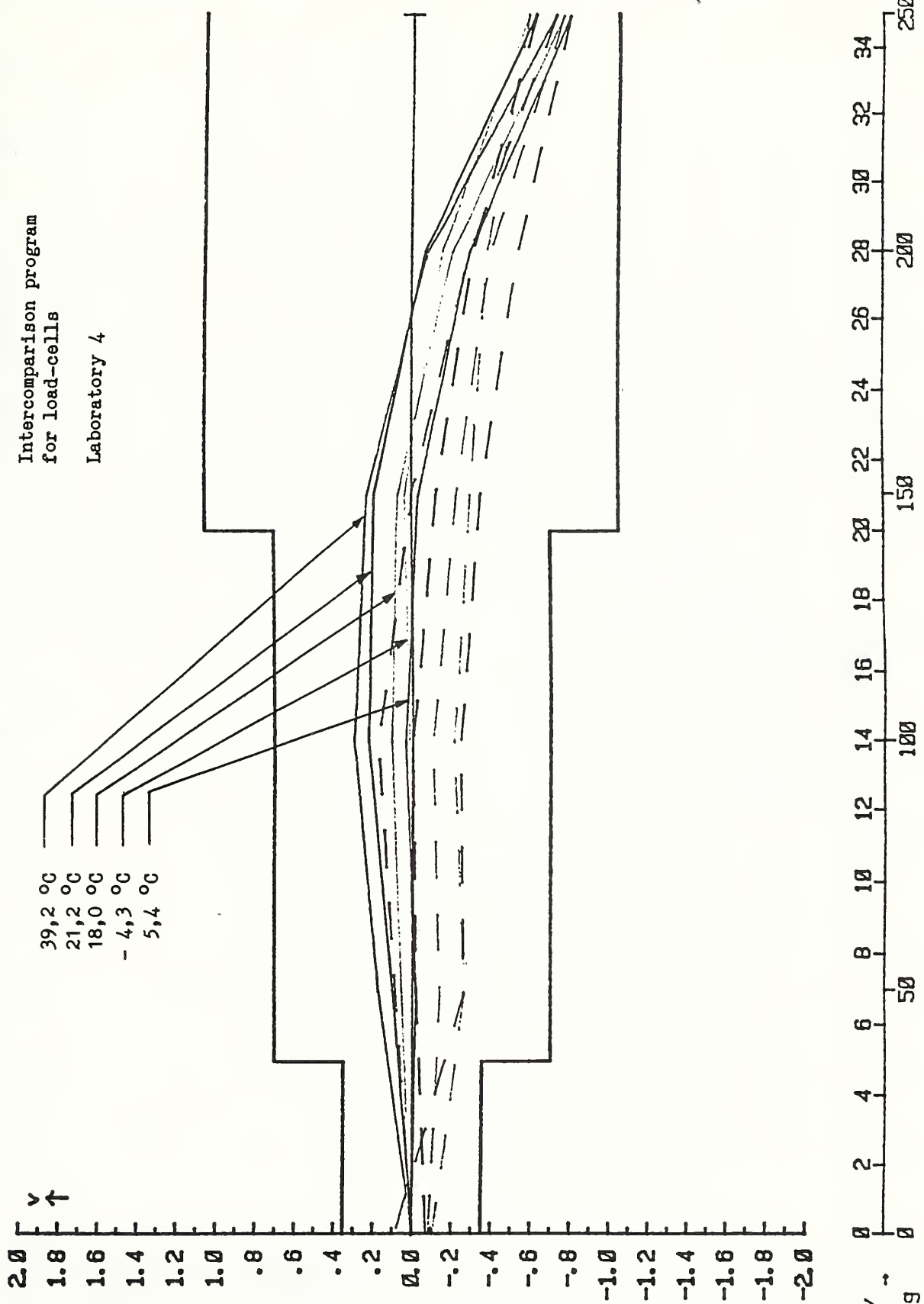

Intercomparison program
for load-cells
Laboratory 5

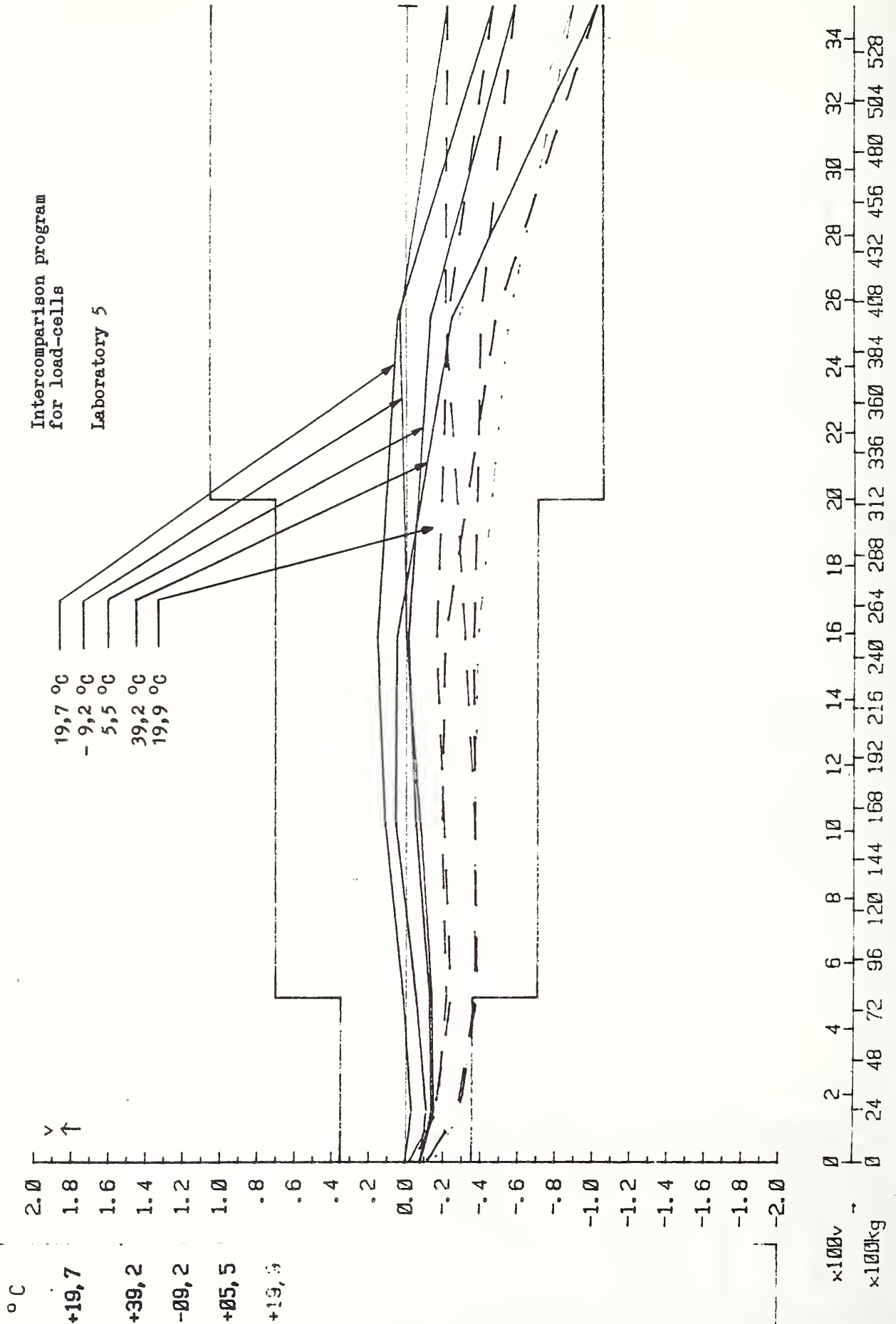

Ordermr.:

Seriesnr.:

Type:

RETEST AT PIVOT LABORATORY

°C

+20,7

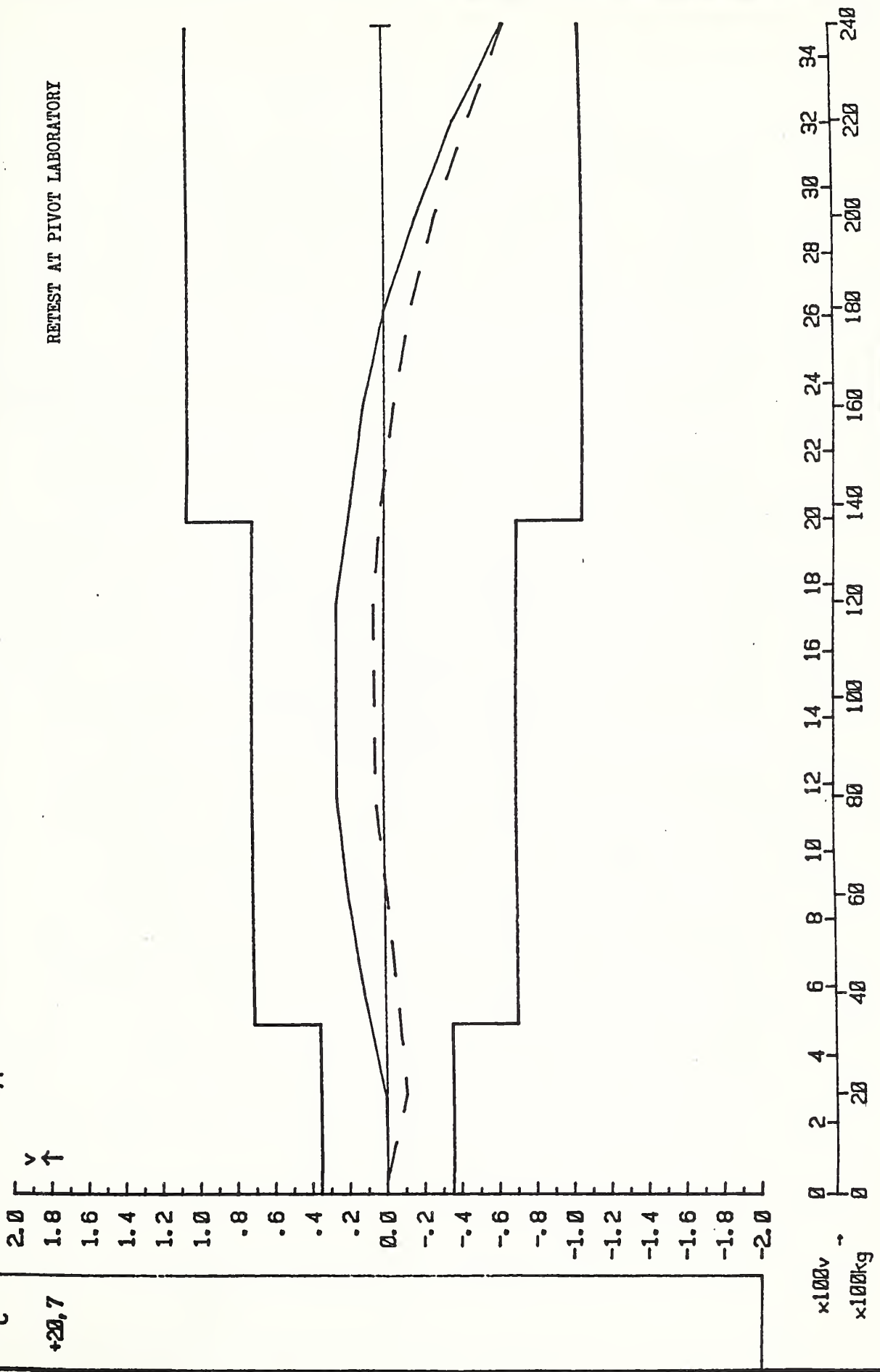

x100v

x100kg

APPENDIX B
PIVOT LABORATORY REPORT
20000 kg LOAD CELL

INTERNATIONAL LOAD CELL INTERCOMPARISON TESTS

PIVOT LABORATORY REPORT ON THE COMPARISON OF RESULTS FOR A 20 t LOAD CELL

JULY 1989

SUMMARY

As pivot laboratory (LAB 4) for the 20 t load cell which formed part of the International load cell intercomparison tests, the results of the five laboratories were compared to ensure that the characteristics of the load cell did not change during the tests and that the results from each laboratory were of the same order.

Generally the results showed that the characteristics of the load cell did not change, but the number of approved scale intervals proposed by each laboratory varied from 2 500 to 4 500.

COMPARISON METHODS

As the results from each laboratory were based on different units, they were adjusted by ratio to give an error expressed in scale intervals (v) with the maximum load used by each laboratory equivalent to 10 000 scale intervals (see Table 1). The following additional adjustments were also made:

- (a) Temperature effect on minimum dead load output return (see Figure 1) and creep (see Figure 2)

No additional adjustments were made as the results were given as differences between two readings for the same load separated by a time interval.

- (b) Temperature effect on minimum dead load output (see Figure 3)

The errors were calculated as the difference between the measurement at the minimum dead load for the first test at 20°C and the measurement at all other temperatures. The measurement for the first test at 20°C was therefore normalised to zero.

- (c) Temperature effect on maximum load output (see Figure 4)

The error at the maximum load for each temperature was calculated with the error at minimum dead load for increasing load, and for each temperature being adjusted to zero.

The results were obtained by calculating the difference between the results for the maximum load output at 20°C for the first test and the results at all other temperatures. The measurement of the maximum load output at 20°C for the first test was therefore normalised to zero.

- (d) Pressure effect on minimum dead load output (see Figure 5)

The errors were calculated as the difference between the results at 1 010 hPa and the results at other pressures. The results at 1 010 hPa were therefore normalised to zero.

No adjustments were made to take into account the small differences between laboratories of minimum dead load, maximum load and temperature, except in the case of LAB 4 for the minimum dead load output return. As the result at -10°C was the critical characteristic for this load cell, the results obtained by LAB 4 at -8 and -6°C were extrapolated to -10°C .

Figures 6-11 show the results for linearity, hysteresis and temperature effect on sensitivity. Figures 6-10 were produced by LABS 1-4. LAB 5 did not produce a graph, so Figure 11 was produced by the LAB 4 from the results given.

Appendix I details the methods used by LAB 4 to assess the maximum number of scale intervals from the results for 10 000 v. The test procedures and equipment used by the laboratories are included in other reports of the intercomparison tests.

TEST RESULTS

Linearity, Hysteresis and Temperature Effect on Sensitivity

Figures 6-11 show that, except for the results from LAB 5, the performance curves can all fit within 6 000 v. The curves show that the most critical result occurred for a load equivalent to 500 v. As LAB 4 used only four test loads this critical result did not show up as no test load was applied at this point.

The maximum number of scale intervals actually recommended by the laboratories were:

LAB 1	-	3 000
LAB 2	-	5 000
LAB 3	-	3 500
LAB 4	-	6 000

The results from LAB 5 were significantly different, particularly at -10 and 5°C , and this limited their results to 2 500 v, once again at the 500 v point.

Figure 4, which compares the results obtained for the maximum load output at various temperatures, shows a wide range in the results, particularly at -10°C . This effect is considerably reduced at a load equivalent to 500 v where the critical results occur, so that except for LAB 5 the variation at maximum load was not significant to the final result.

Minimum Dead Load Output Return

Although the results for linearity, hysteresis and temperature effect on sensitivity would allow 6 000 v (except for LAB 5), all laboratories found that the minimum dead load output return at -10°C limited the load cell to less than 6 000 v. The results are shown in Figure 1, and although the variation between laboratories is only 0.5 in 10 000, this is equivalent to a variation in allowable number of scale intervals of 1 500. The number of scale intervals for the various laboratories based on the results were:

LAB 1	-	3 000
LAB 2	-	4 000
LAB 3	-	3 500
LAB 4	-	4 000 (first test) and 4 500 (second test)
LAB 5	-	4 000

This is one of the most sensitive factors controlling the number of approved scale intervals.

Creep

The results of the four hour creep tests at the various temperatures is shown in Figure 2. The errors are approximately twice the errors for minimum dead load output return but as the allowable error is three times (1.5 v for creep and 0.5 v for minimum dead load output return), the creep errors are not a limiting factor for determining the maximum number of scale intervals.

Minimum Scale Interval

The value of the minimum scale interval (v_{\min}) is determined by the results of the tests for temperature and pressure effects on the minimum dead load output.

(a) Temperature Effect

The temperature effect (see Figure 3) is shown by the slope of the curve and varies from 0.24 to 0.38 in 10 000 scale intervals per 5°C between the laboratories.

Both LAB 4 results are displaced from the results from the other laboratories although the slope is similar. This is probably due to the difference in procedure between LAB 4 and other laboratories for taking the minimum dead load output reading at each temperature. LAB 4 takes readings after the creep test for one temperature and before the start of the load tests at the new temperature. All other laboratories take the minimum dead load output readings before the load tests at each temperature.

A special test conducted by LAB 4 conformed with the procedure used by other laboratories and was in agreement with their results.

(b) Pressure Effect

The pressure effect (see Figure 4) is of the order of 0.30 in 10 000 scale intervals per 1 kPa for all laboratories which carried out this test.

Although these effects are of the same order, the maximum permissible error for temperature effect is less than for pressure (0.7 v_{\min} against 1.0 v_{\min}) so that the results for temperature will dictate v_{\min} . The equivalent range of v_{\min} between the various laboratories is from 0.61 to 1.49 kg.

Not all laboratories carried out the pressure test and quoted a minimum scale interval. This was not required for the intercomparison tests but it is just as important as the maximum number of scale intervals in specifying the performance of a load cell. Otherwise the tests for temperature and pressure effects on minimum dead load output are not necessary.

For this load cell v_{\min} is sufficiently small so that when multiplied by the maximum number of v_{\min} scale intervals the capacity of the load cell is not exceeded.

CONCLUSIONS

Conclusions reached from the analysis of the test results are:

- (a) It is important to apply sufficient test loads, particularly near the changes in maximum permissible errors, to determine the load curves. This is illustrated by the LAB 4 results.
- (b) The minimum dead load output reading should be taken during the three load tests at each temperature and these should be used to determine the effect of temperature on minimum dead load output. This is also illustrated by LAB 4 results.
- (c) The results obtained by LAB 5 for the combined effects of linearity, hysteresis and temperature effect on sensitivity are significantly different to all other laboratories with respect to the effect of temperature on the load curves. These results limited the load cell to 2 500 scale intervals.
- (d) LAB 1 did not carry out the pressure or the creep test.
- (e) The minimum scale interval was not specified by LABS 1, 3 or 5.
- (f) Except for LAB 5, the maximum number of scale intervals was limited by the results for the minimum dead load output return. Despite good agreement in results, the number of scale intervals varied from 3 000 to 4 500 v due to the demanding requirements of International Recommendation 60.
- (g) A summary of the recommended number of scale intervals proposed by the five laboratories for the load cell are:

LAB 1	-	3 000 (Interpreted by LAB 4 from LAB 1 results)
LAB 2	-	4 000
LAB 3	-	3 500
LAB 4	-	4 000 and 4 500
LAB 5	-	2 500

Recommended minimum verification scale intervals are as follows:

LAB 1	-	-
LAB 2	-	0.61 kg
LAB 3	-	-
LAB 4	-	1.14 and 1.49 kg
LAB 5	-	-

The manufacturer of the load cell rated it for 3 000 scale intervals. All laboratories (except LAB 5) would accept it for 3 000 v.

APPENDIX I. ASSESSMENT OF LOAD CELL TEST RESULTS FOR 10 000 v

Submission no.

Manufacturer

Load cell type

Load cell class

Load cell serial number

Load cell capacity (kg)

Test dead load (kg)

Headwork used

Method of loading

Test results for 10 000 v (explained below)	Maximum error (Intervals) in 10 000 v	Number of verification Intervals (v)
Linearity, hysteresis and temperature effect on sensitivity	A
Full load creep	B at °C
Minimum dead load output return	C at °C
Temperature effect on minimum dead load output per 5°C	D ... from ... °C to ... °C
Pressure effect on minimum dead load output per kPa	E ... from ... kPa to ... kPa

Limiting value of maximum number of Intervals

Limiting value of minimum verification Interval

Note: [MPE] Indicates the absolute value of the maximum permissible error. The maximum permissible errors (MPE) used should be the value appropriate for the number of verification Intervals anticipated.

Linearity, Hysteresis and Temperature Effect on Sensitivity

The number of verification intervals for linearity, hysteresis and temperature effect on sensitivity is based on the error limits which just enclose the performance curves for the tests. This may be done by trial and error using say overlays of the error limits for various numbers of intervals.

Full Load Creep

Maximum number of verification intervals is $1.5 \times [\text{MPE}] \times 10\,000 / B$ where B is full load creep error.

Note: If $B < 7.8 \text{ v}$ use [MPE] for $> 2\,000 \text{ v}$ or if $B > 7.8 \text{ v}$ use [MPE] for $< 2\,000 \text{ v}$

Minimum Dead Load Output Return

Maximum number of verification intervals = $0.5 \times 10\,000 / C$ where C is minimum dead load output return error.

Temperature Effect on Minimum Dead Load per 5°C

Minimum verification interval (v_{\min}) = maximum capacity $\times D / 0.7 \times 10\,000$ where D is temperature effect on minimum dead load output per 5°C.

Pressure Effect on Minimum Dead Load Output per kPa

Minimum verification interval (v_{\min}) = maximum capacity $\times E / 10\,000$ where E is the pressure effect on minimum dead load output per kPa.

Table 1. Comparison of Results for 20 t Load Cell
(error in scale intervals for 10 000 scale intervals (max))

(a) Temperature Effect on Minimum Dead Load Output Return

Temp (°C)	LAB 4 (1)	LAB 1	LAB 3	LAB 4 (2)	LAB 5	LAB 2
+20	-0.50	-0.55	-0.76	-0.5	-0.65	-0.66
+40	-0.20	-0.45	-0.57	-0.2	-0.70	-0.46
-10	-1.15	-1.45	-1.30	-1.0	-1.15	-1.25
+5	-0.75	-	-1.09	-0.9	-0.90	-
+20	-0.60	-	-	-0.4	-0.75	-

(b) Temperature Effect on Creep

Temp (°C)	LAB 4 (1)	LAB 1	LAB 3	LAB 4 (2)	LAB 5	LAB 2
+20	-1.15	-	-1.72	-1.55	-1.60	-1.22
+40	-1.15	-	-0.95	-1.25	-1.60	-0.86
-10	-1.95	-	-2.15	-2.00	-2.26	-1.96
+5	-1.65	-	-2.07	-1.70	-2.01	-1.72
+20	-1.85	-	-	-1.35	-1.96	-

(c) Temperature Effect on Minimum Dead Load Output

Temp (°C)	LAB 4 (1)	LAB 1	LAB 3	LAB 4 (2)	LAB 5	LAB 2	LAB 4 (3)
+20	0.00	0.00	0.00	0.00	0.00	0.00	0.00
+40	+0.60	+0.20	+1.18	+0.65	+0.80	+0.90	+0.85
-10	-3.20	-1.80	-1.58	-3.40	-2.10	-1.36	-2.30
+5	-2.35	-1.15	-0.08	-2.25	-0.95	-0.42	-1.35
+20	-1.75	-0.50	+0.39	-1.15	-0.15	+0.38	-0.30

(d) Temperature Effect on Maximum Load Output

Temp (°C)	LAB 4 (1)	LAB 1	LAB 3	LAB 4 (2)	LAB 5	LAB 2
+20	0.00	0.00	0.00	0.00	0.00	0.00
+40	-0.11	-0.85	-0.20	-0.50	+0.30	-0.65
-10	+0.90	-0.25	+1.55	+0.57	-1.12	+0.26
+5	+0.28	-0.65	+0.18	-0.05	-1.39	-0.49
+20	+0.25	-0.35	-0.03	+0.22	-0.84	-0.70

(e) Pressure Effect on Minimum Dead Load Output

Pressure (hPa)	LAB 4 (1)	LAB 1	LAB 3	LAB 4 (2)	LAB 5 ^a	LAB 2
1 050	1.20	-	-	-	1.10	-
1 047	-	-	1.04	-	-	-
1 040	-	-	0.87	-	-	-
1 035	-	-	-	-	0.85	0.74
1 030	0.60	-	-	-	0.65	0.61
1 027	-	-	0.50	-	0.60	-
1 025	-	-	-	-	0.40	0.45
1 020	-	-	-	-	0.20	0.31
1 015	-	-	-	-	0.10	0.15
1 013	-	-	0.10	-	-	-
1 010	0.00	-	0.00	-	0.00	0.00
1 000	-0.30	-	-0.32	-	0.35	-
990	-0.60	-	-	-	0.71	-
987	-	-	-0.68	-	-	-
973	-	-	-1.07	-	-	-
970	-1.15	-	-	-	1.31	-
950	-1.75	-	-	-	-	-
947	-	-	-1.82	-	-	-

* Not all readings plotted for LAB 5 on Figure 5 are shown here.

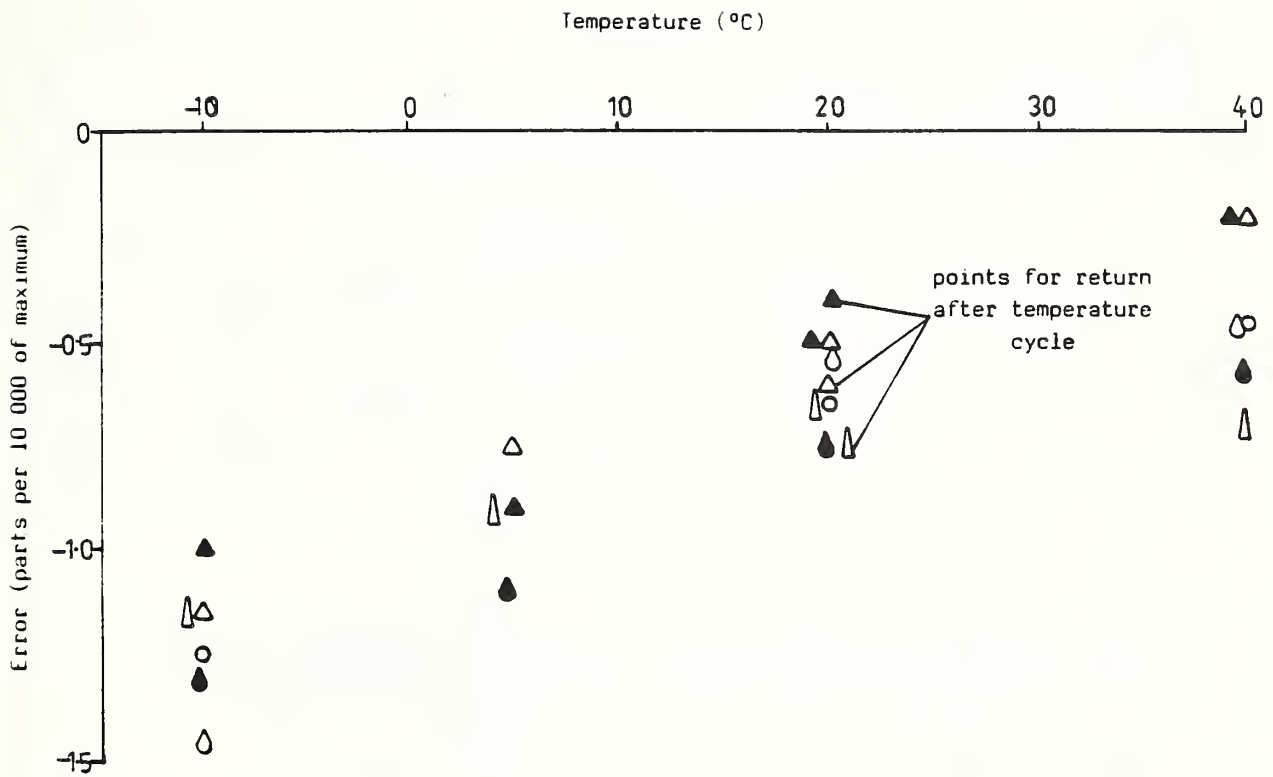

Figure 1. Temperature effect on minimum dead load output return
 (△LAB 4 first test, ▲ LAB 4 repeat test, ◊ LAB 1, ◆ LAB 3, ○ LAB 2, ▽LAB 5)

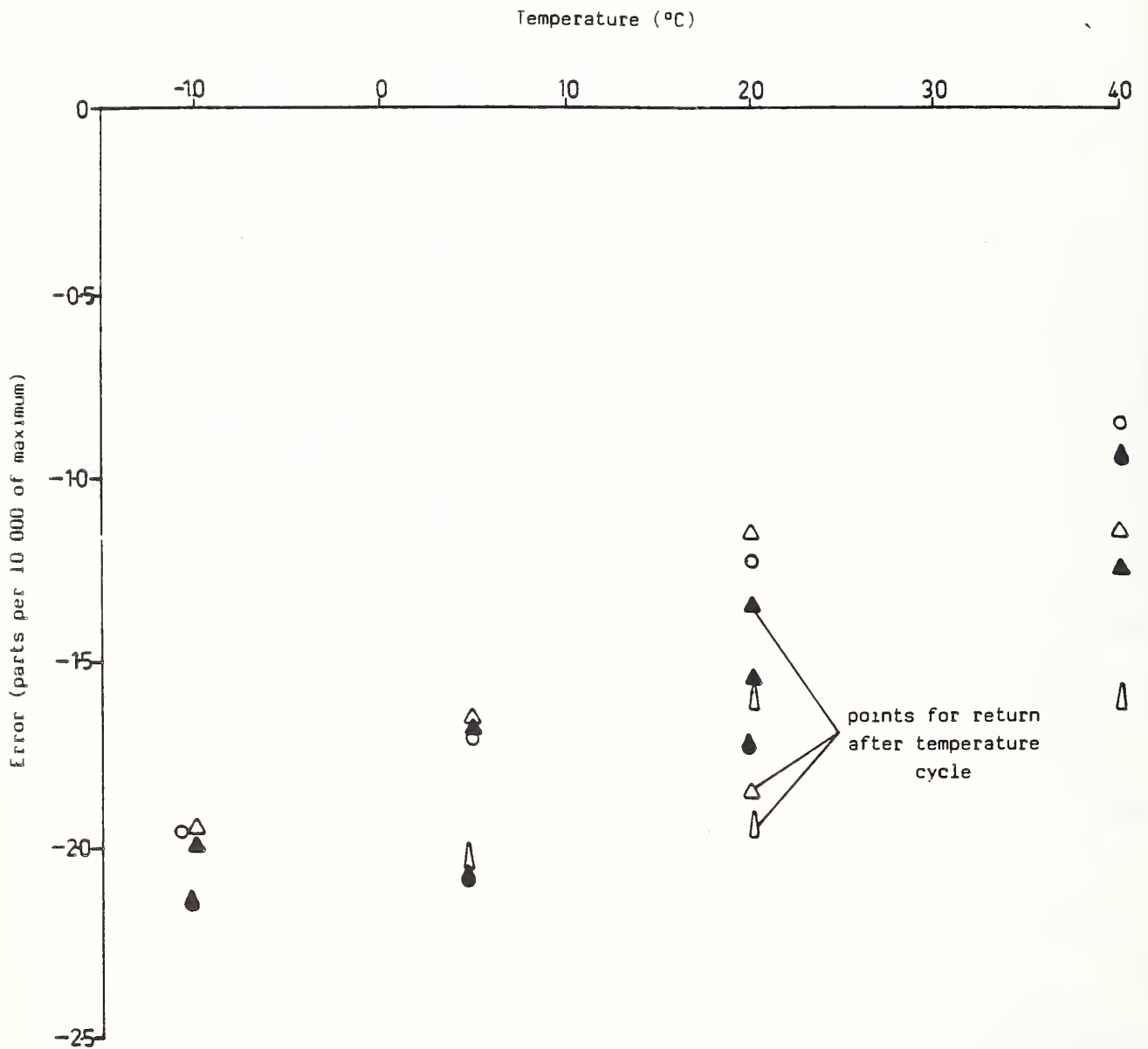

Figure 2. Temperature effect on creep
 (△ LAB 4 first test, ▲ LAB 4 repeat test, ◆ LAB 3, ○ LAB 2, △ LAB 5)

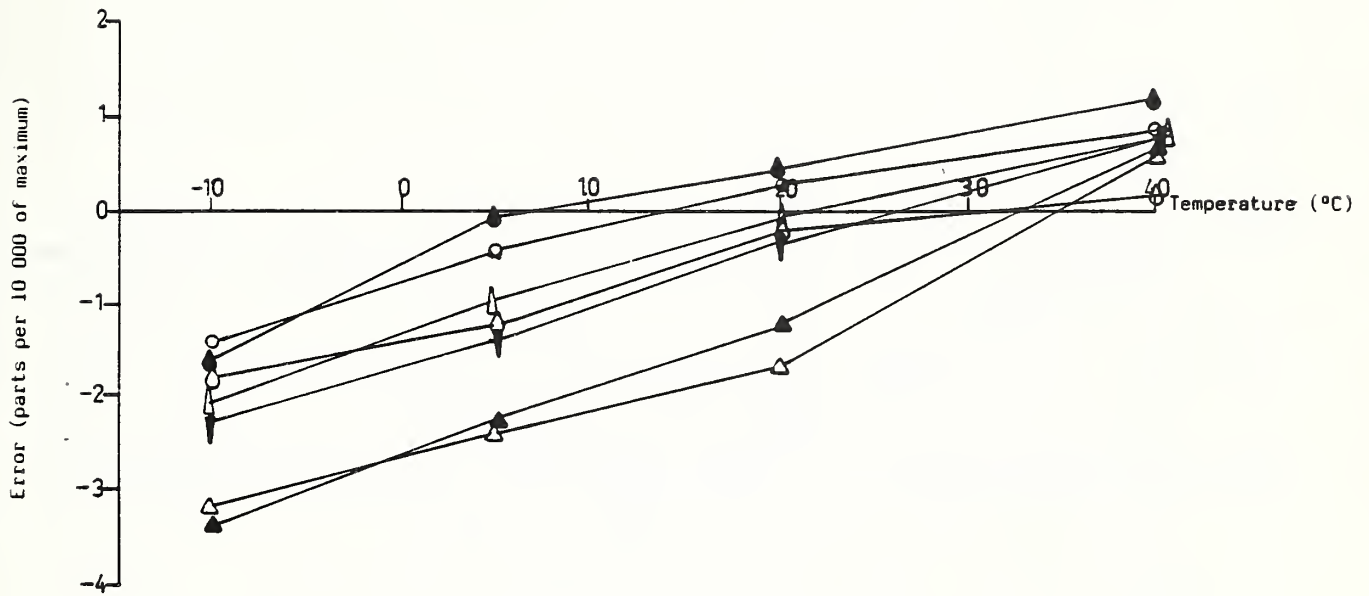

Figure 3. Temperature effect on minimum dead load output
 (Δ LAB 4 first test, ▲ LAB 4 repeat test, ∇ LAB 4 special test,
 ◊ LAB 1, ◆ LAB 3, ○ LAB 2, ◓ LAB 5)

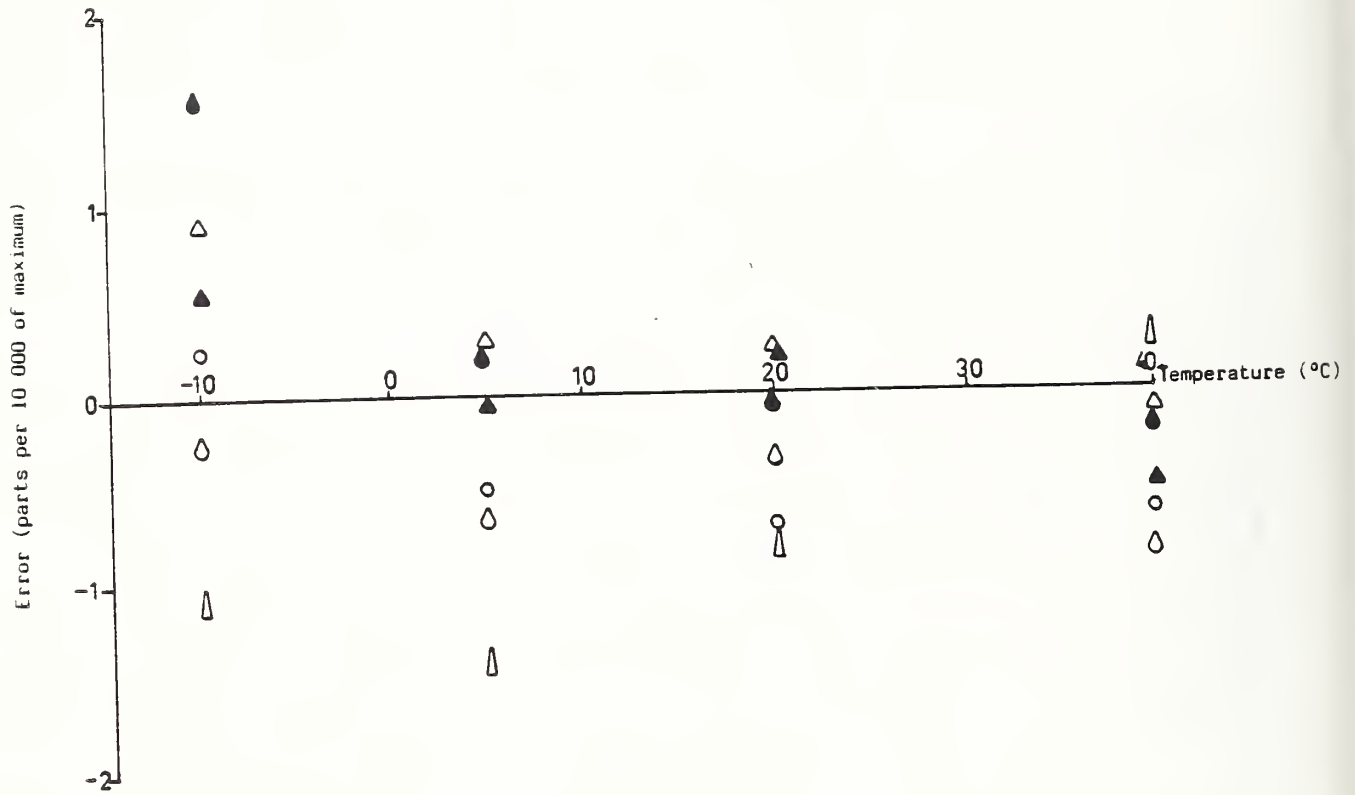

Figure 4. Temperature effect on maximum load output
 (Δ LAB 4 first test, ▲ LAB 4 repeat test, ◊ LAB 1, ◆ LAB 3, ○ LAB 2, ◃ LAB 5)

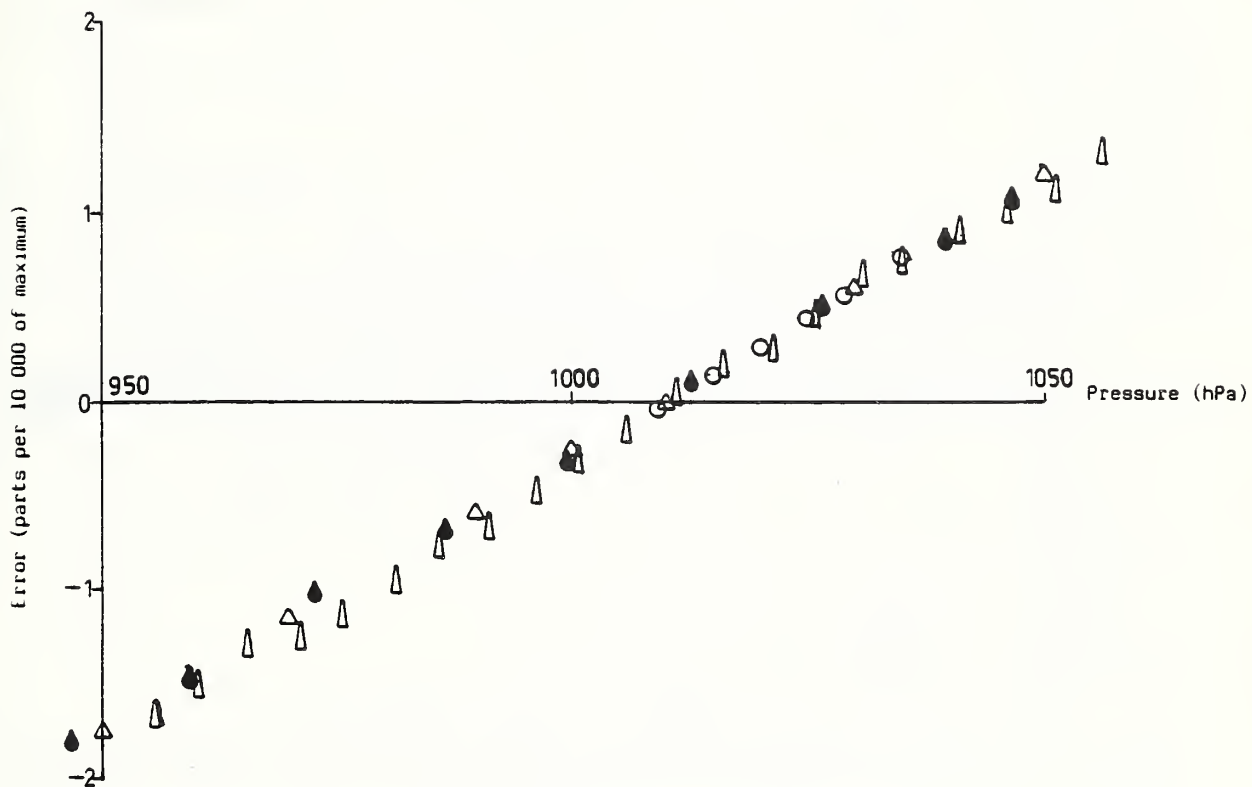

Figure 5. Pressure effect on minimum dead load output
 (△LAB 4 first test, ▲ LAB 4 repeat test, ▽ LAB 1, ● LAB 3, ○ LAB 2, ▽ LAB 5)

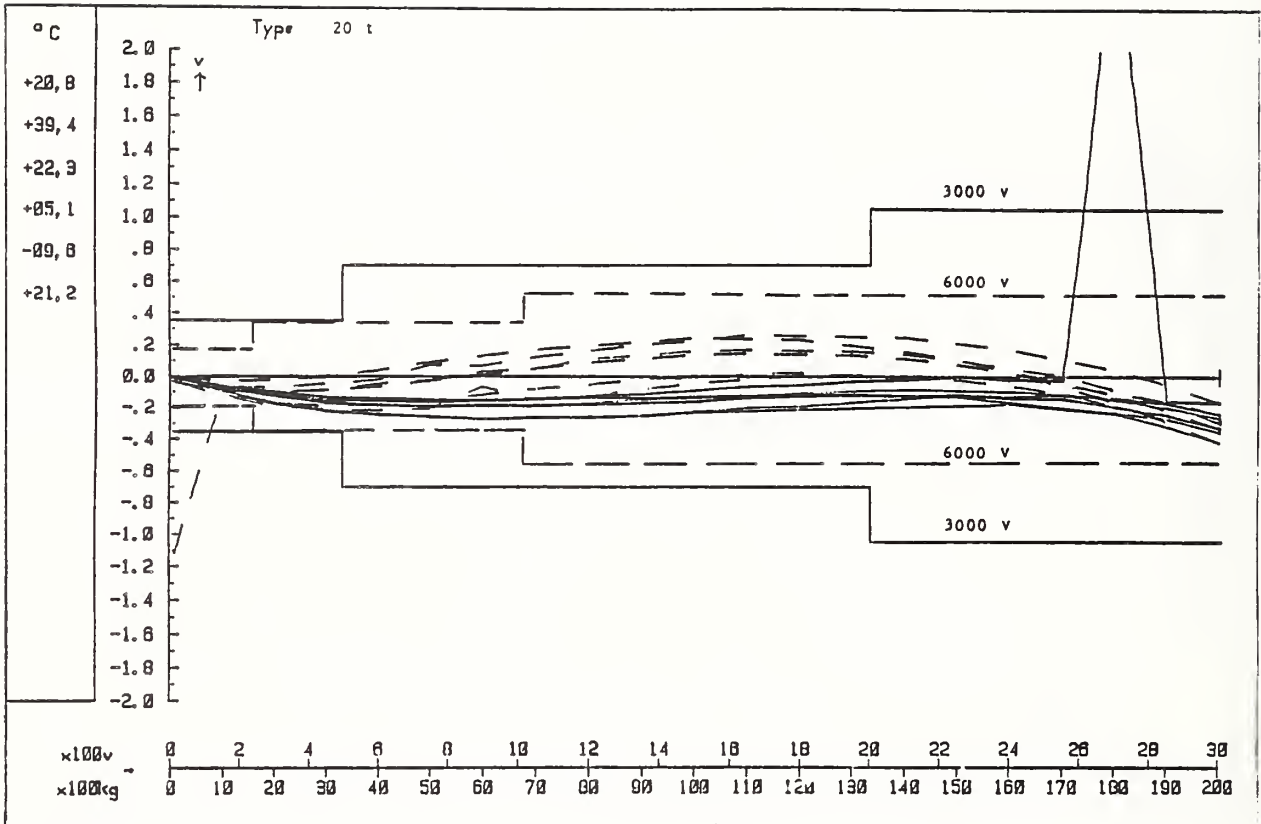

Figure 6. Linearity, hysteresis and temperature effect for LAB 1

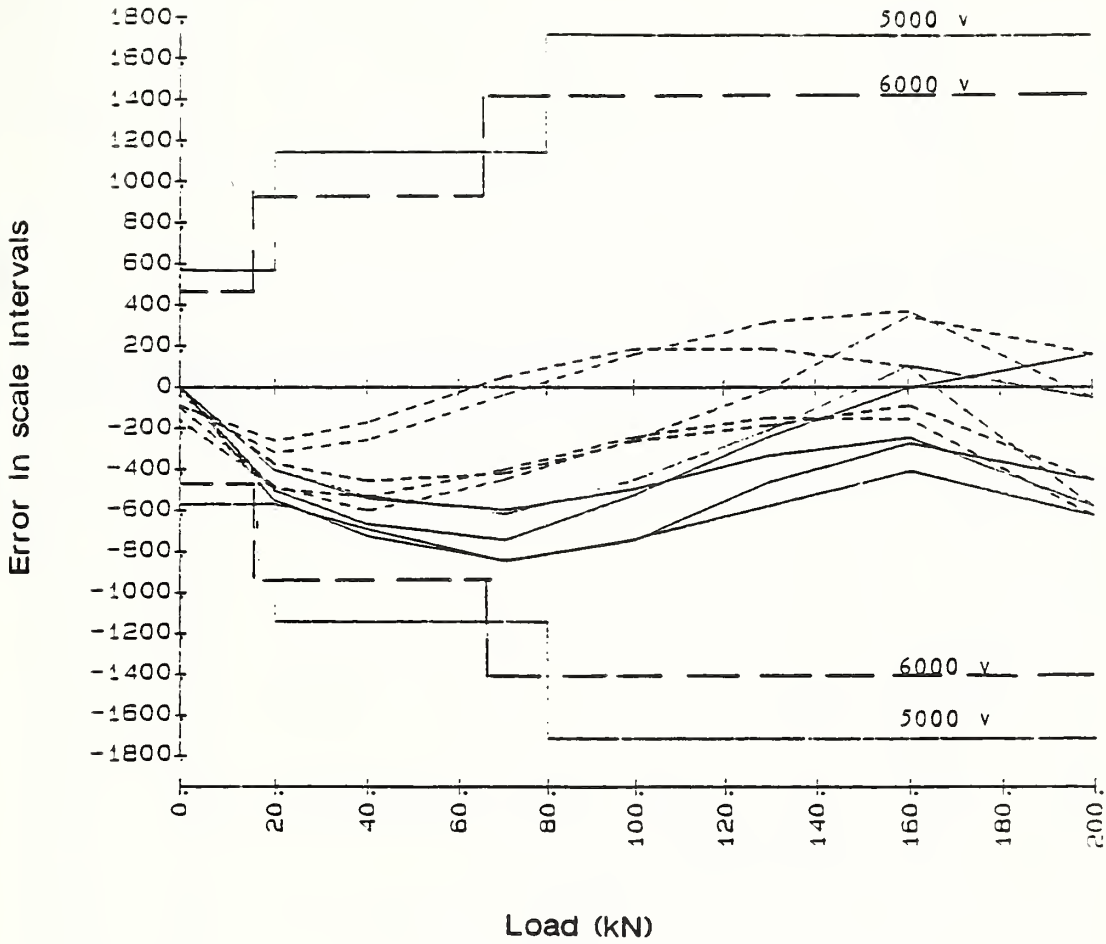

Figure 7. Linearity, hysteresis and temperature effect for LAB 2 (test 1, 22.7°C; test 2, 40°C; test 3, -10°C; test 4, 5°C; test 5, 20°C)

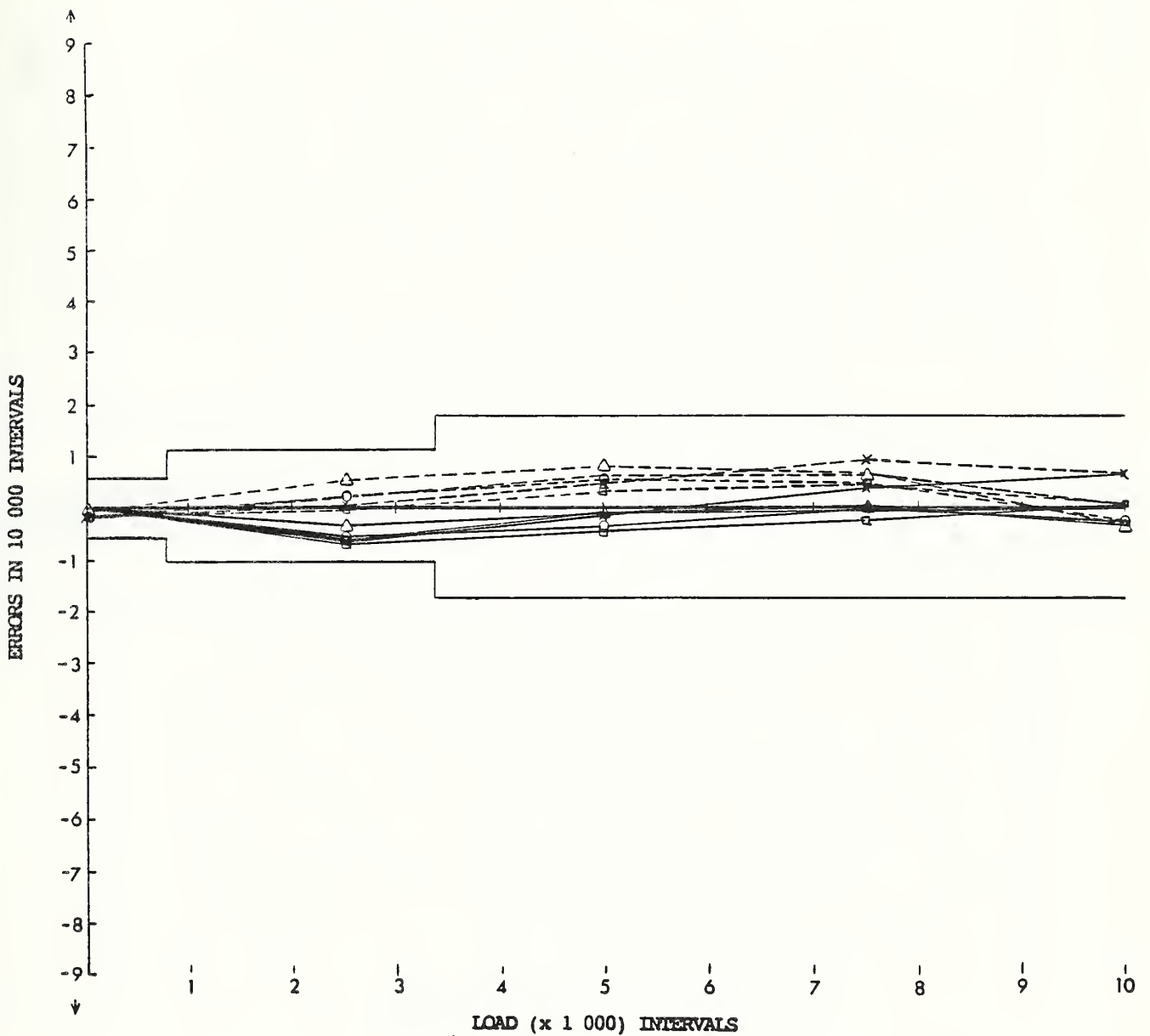

Figure 9. Linearity, hysteresis and temperature effect for LAB 4, first test (error limits for 6 000 v)

- o— Increasing 20.6°C, --o-- decreasing 20.6°C
- Δ— Increasing 39.3°C, --Δ-- decreasing 39.3°C
- x— Increasing -8.0°C, --x-- decreasing -8.0°C
- ▽— Increasing 19.7°C, --▽-- decreasing 19.7°C
- Increasing 5.5°C, --□-- decreasing 5.5°C

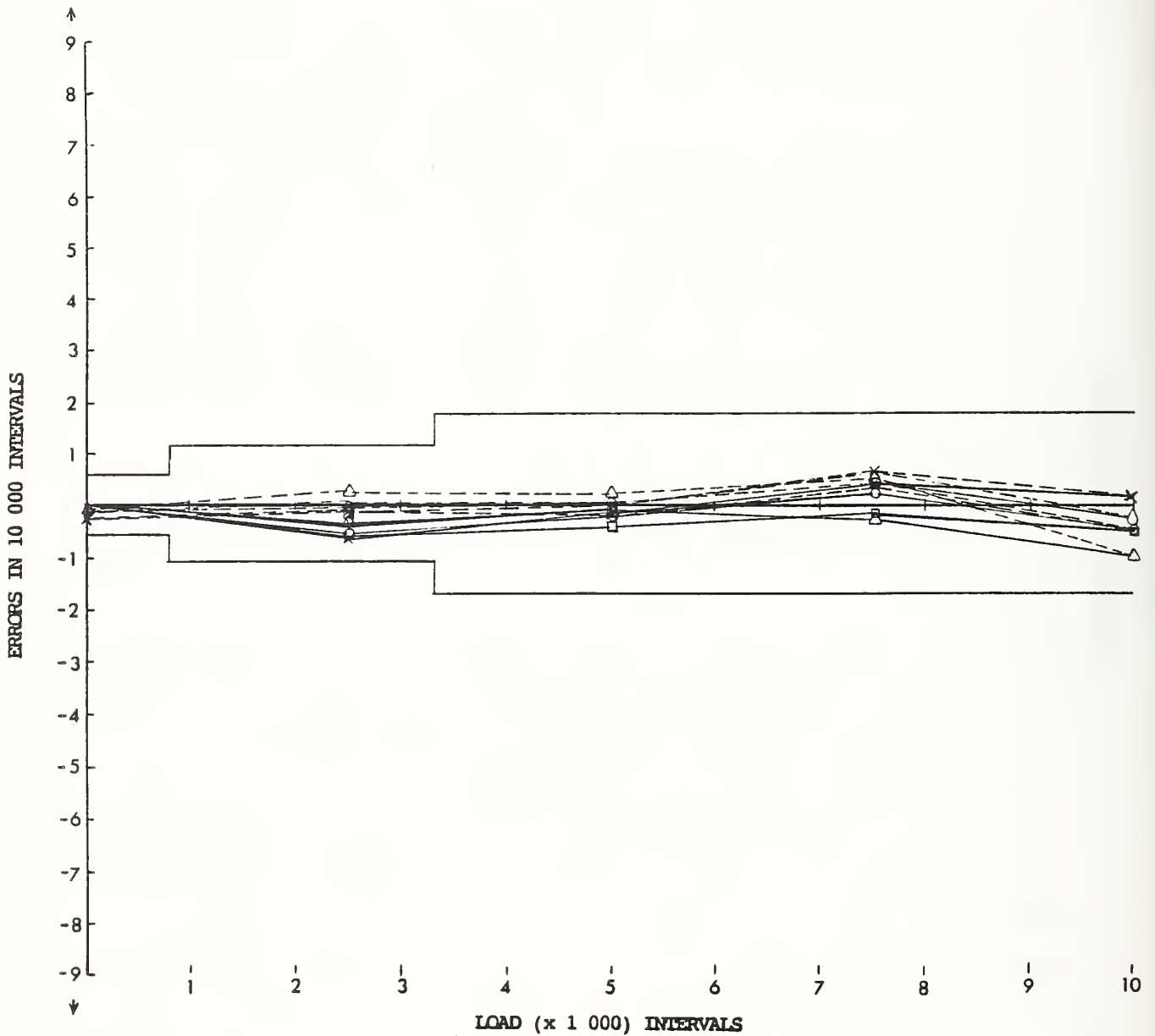

Figure 10. Linearity, hysteresis and temperature effect for LAB 4, second test (error limits for 6 000 v)

- Increasing 19.9°C, --○-- decreasing 19.9°C
- △— Increasing 38.8°C, --△-- decreasing 38.8°C
- x— Increasing -6.0°C, --x-- decreasing -6.0°C
- ◊— Increasing 20.8°C, --◊-- decreasing 20.8°C
- Increasing 6.6°C, --□-- decreasing 6.6°C

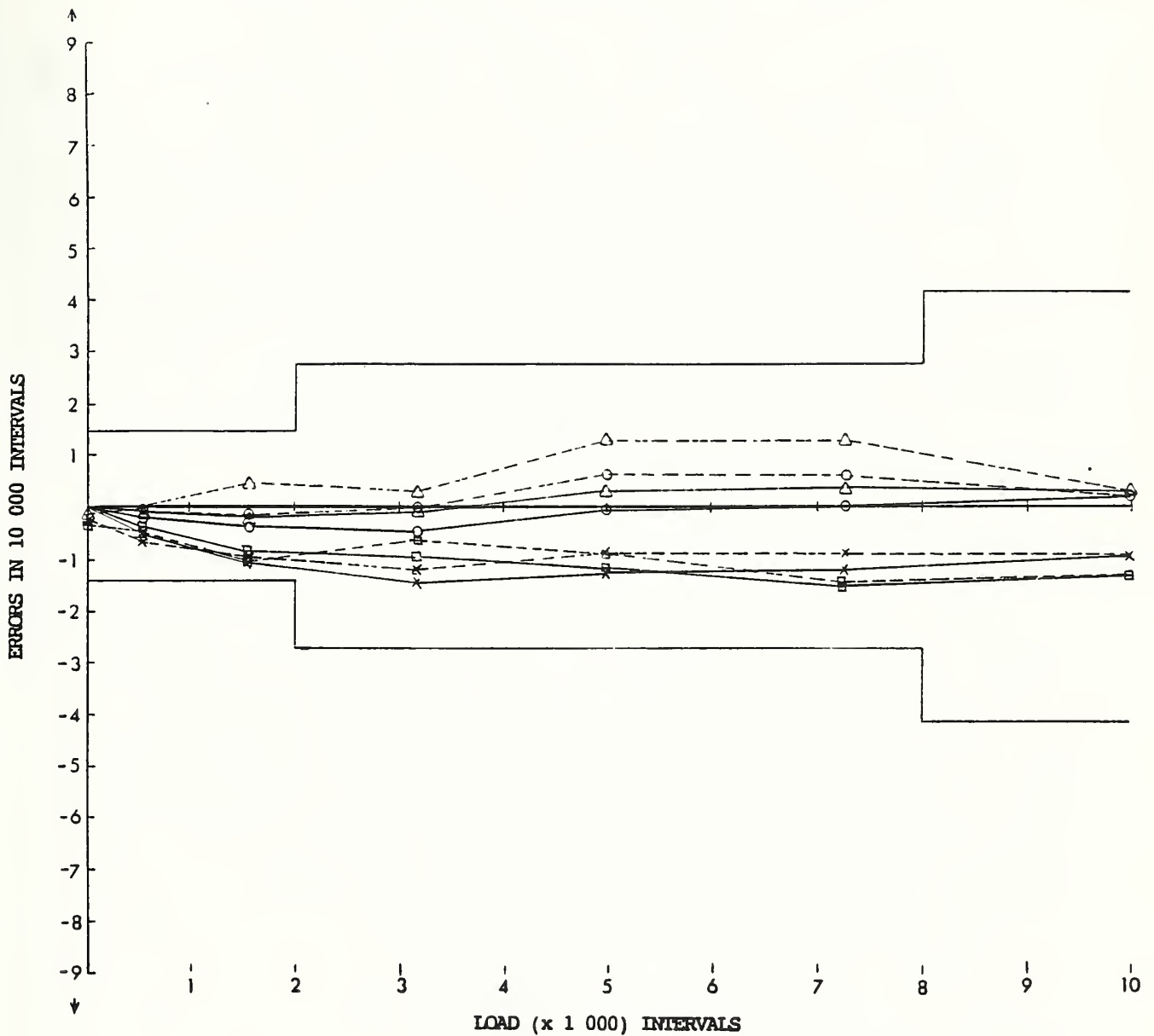

Figure 11. Linearity, hysteresis and temperature effect calculated by LAB 4 for LAB 5 (error limits for 2 500 v)

- Increasing 20°C, --○-- decreasing 20°C
- △— Increasing 40°C, --△-- decreasing 40°C
- x— Increasing -10°C, --x-- decreasing -10°C
- Increasing 5°C, --□-- decreasing 5°C

APPENDIX C
PIVOT LABORATORY REPORT
1500 kg LOAD CELL

INTERNATIONAL LOAD CELL INTERCOMPARISON EXERCISE OIML SP7 Sr8
PIVOT LABORATORY REPORT BY NWML FOR THE 1.5 t LOAD CELL

INTRODUCTION

The NWML is the pivot laboratory for the 1.5 tonne load cell used in the above exercise. The other states involved in testing this device were Australia (National Standards Commission) and USA (National Bureau of Standards). As the NWML deadweight test facility was not operational during the period of the exercise, testing on behalf of NWML was contracted-out to W & T Avery Ltd Transducer Development Division whose work was monitored by the reporter. The NWML facility became available during 1988 and was used to complete the testing of the 1.5 t load cell. The circuit for this device was therefore:

- test 1. Avery (UK)
- test 2. USA (NBS)
- test 3. Australia (NSC)
- test 4. Avery (UK)
- test 5. NWML

The UK participation was further complicated by the lack of a temperature control facility for the Avery deadweight machine during test 1. This test was done by using the deadweight machine at ambient temperature to achieve four increments. The effect of variation in temperature was then tested separately by use of standard weights to maximum capacity in one increment inside an environmental chamber.

Scope of evaluation

Results from testing the 1.5 tonne load cell have been received from NSC (Australia) and NBS (USA) along with recommended load cell intervals for the device. We therefore have four sets of comparable results from NSC, NBS, Avery (2nd test) and NWML. At the time of writing, NWML have yet to programme computer facilities to process load cell test results entirely in accord with OIML RI 60. To avoid further delay in reporting, NWML is forwarding this report on the basis of assessment of linearity and hysteresis using the above four sets of comparable results.

To reap maximum benefit from the exercise NWML recognises the need to supplement this report with a more comprehensive assessment by inclusion of comparison of results for repeatability and temperature effect on minimum deadload output.

Results for minimum deadload output return and creep were only judged against the number of load cell intervals derived from assessment of linearity and hysteresis. Again we recognise the need to make an individual assessment of these characteristics in due course. All four sets of results assessed as above by NWML showed that for the number of load cell intervals at which the load cell performance was satisfactory for linearity and hysteresis, it would also have been satisfactory with regard to creep and minimum deadload output return.

Linearity and hysteresis

Graphs were made showing error (relative to the reference envelope) against load for each of the five temperature tests for each of the four sets of National tests (i.e. 20 graphs). The curves for the Lab 4 and Pivot results show a marked similarity, typified by the Lab 4 40 °C test attached as Figure 1 and Pivot 1st 20 °C test at Figure 2. The curves for the Lab 3 results are similar to Lab 4 and Pivot except for the hysteresis characteristic here shown in Figure 3, whilst the curves for the Lab 5 results show rather differing and slightly inconsistent characteristics shown by the 1st 20 °C test at Figure 4 and 5 °C test at Figure 5.

Though the above curves show some similarities their error envelopes vary considerably. To show this, TABLE 1 presents the load cell intervals which NWML would deduce from the results of each Laboratory's incremental loading test at each temperature. The penultimate column giving the overall assessment which NWML would have made and the final column giving the testing laboratories' assessment. Figure 6 is intended to illustrate this variation, though only in a primitive form as, of course, the adjoining lines merely represent the sequence of temperature tests and are not representative of the two variables.

Conclusions

Using results of the load cell tests done by NBS, NSC, Avery and NWML to allocate the number of load cell verification intervals based solely on assessment of linearity and hysteresis; the exercise could not be used to justify confidence in either:

(a) another laboratory's evaluation of load cell verification intervals, or

(b) another laboratory's test results.

The statement of (a) is due to the disparity in the number of load cell verification intervals recommended by each laboratory (see TABLE 1).

The statement at (b) is due to the disparity in the number of load cell verification intervals evaluated by NWML using each of the laboratory's results (see TABLE 1).

In order to make best use of the results from the exercise and help understand why the results are unfavourable, there is a need for NWML to supplement this assessment of linearity and hysteresis by using the same results to evaluate all other recognised characteristics of load cells.



Roger Robinson

NWML

22 September 1988

**TABLE 1 VERIFICATION INTERVALS FOR THE 1.5 TONNE LOAD CELL
ASSESSMENT OF RESULTS FROM INTERNATIONAL LOAD CELL INTERCOMPARISON EXERCISE**

LABORATORY'S TEST RESULTS	NWML ASSESSED					TESTING LABORATORY ASSESSMENT
	TEMPERATURE (°C)					
	20	40	-10	5	20	
Lab 3	4000	2000	4000	5000	7000	2000
Lab 4	3500	4000	2500	3000	3500	3000
Lab 5	7000	5500	1500	4000	5500	-
Pivot	2000	1000	1000	1500	2000	1000

FIGURE 1

LINEARITY & HYSTERESIS

Lab 4 40°C

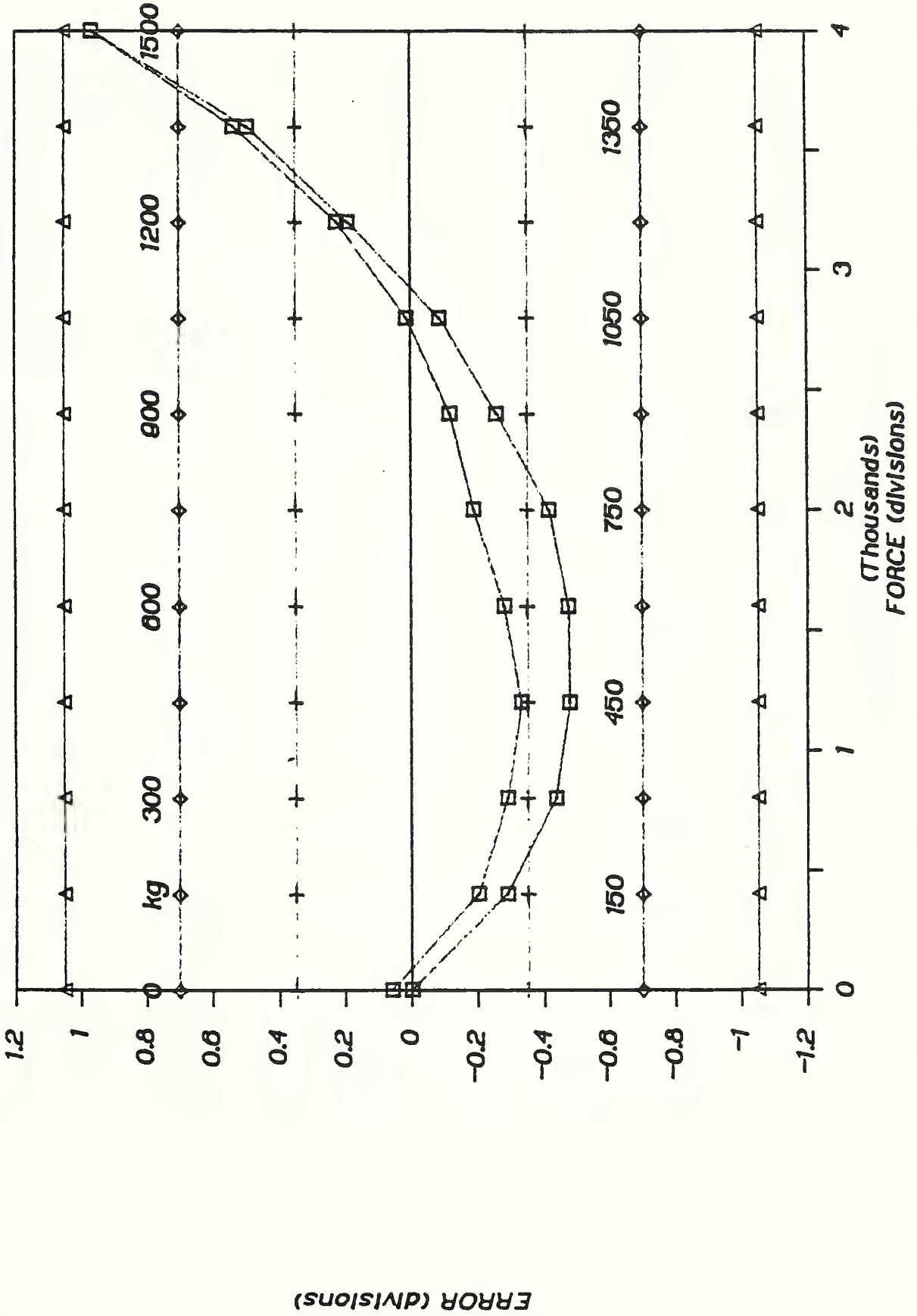

FIGURE 2

LINEARITY & HYSTERESIS

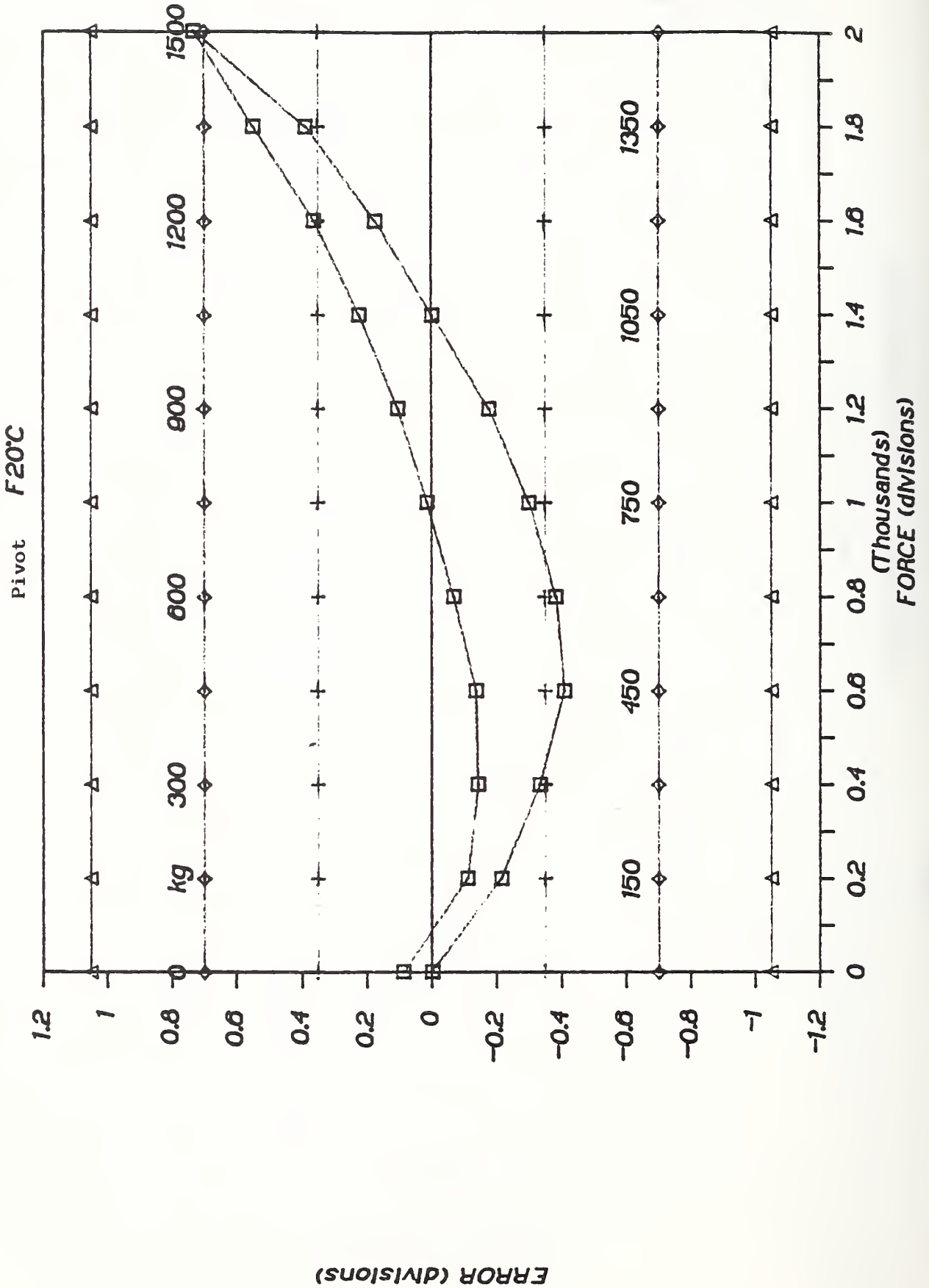

FIGURE 3

LINEARITY & HYSTERESIS

Lab 3 5°C

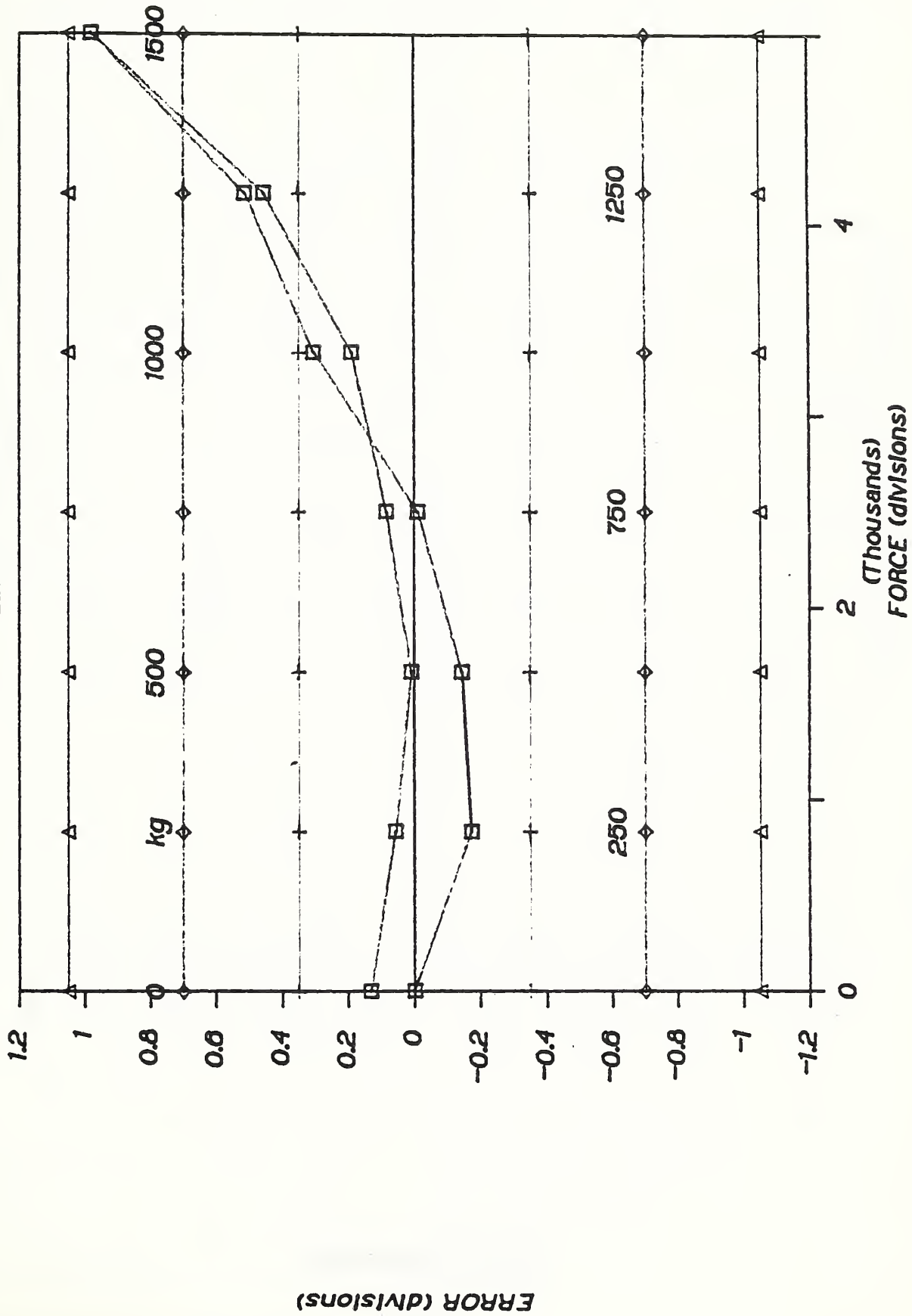

FIGURE 4

LINEARITY & HYSTERESIS

Lab 5 F 20°C

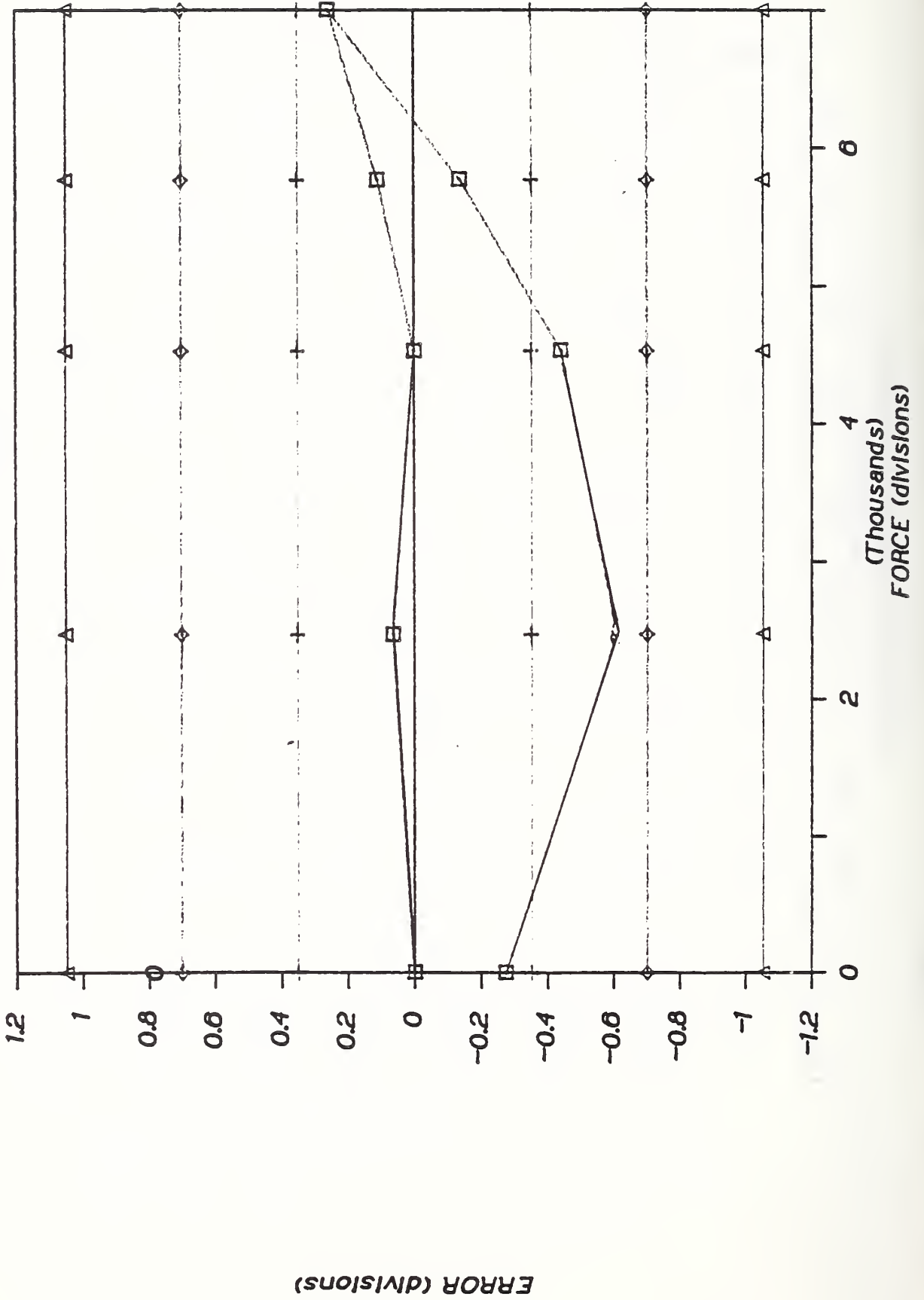

FIGURE 5

LINEARITY & HYSTERESIS

Lab 5 5°C

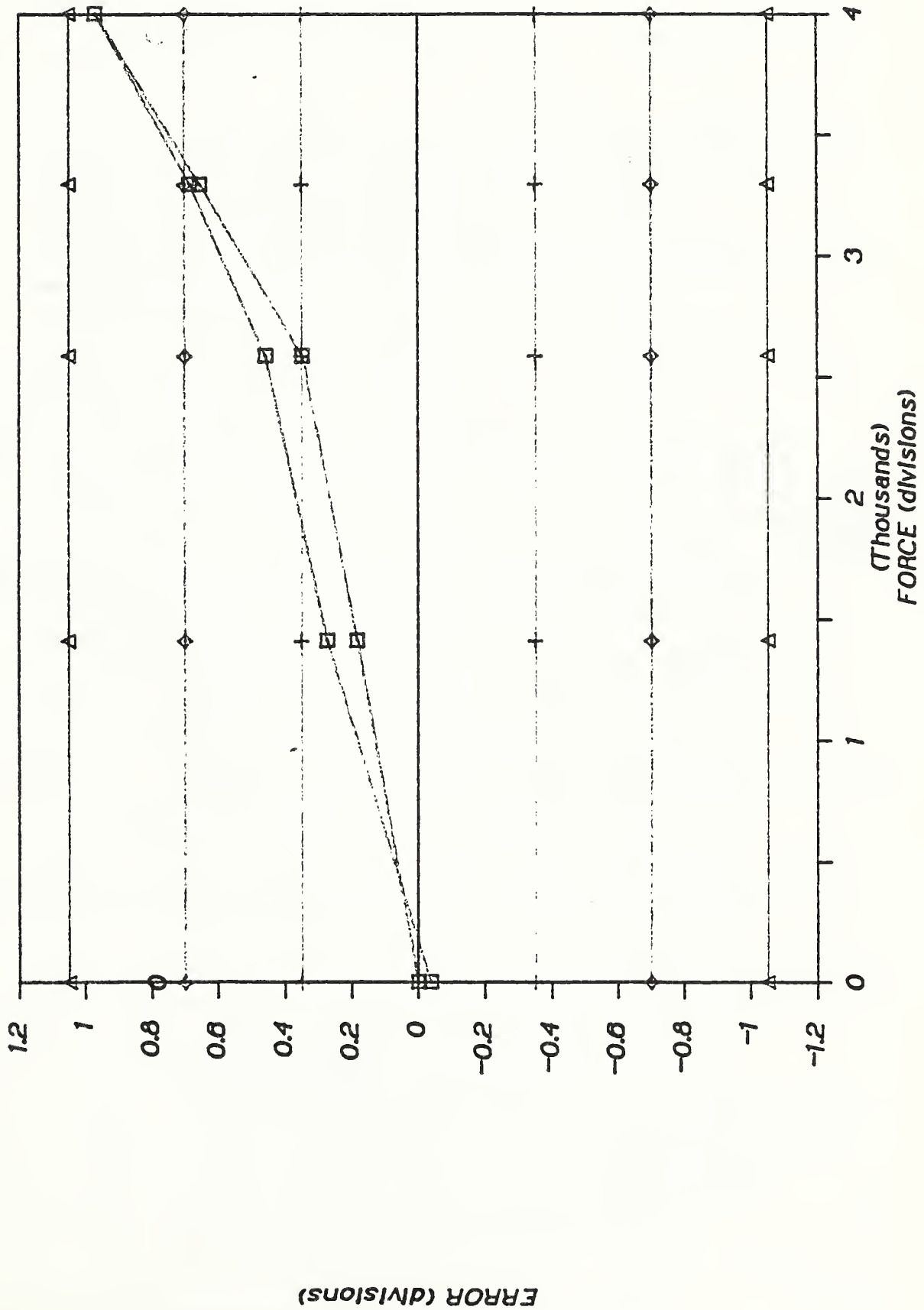
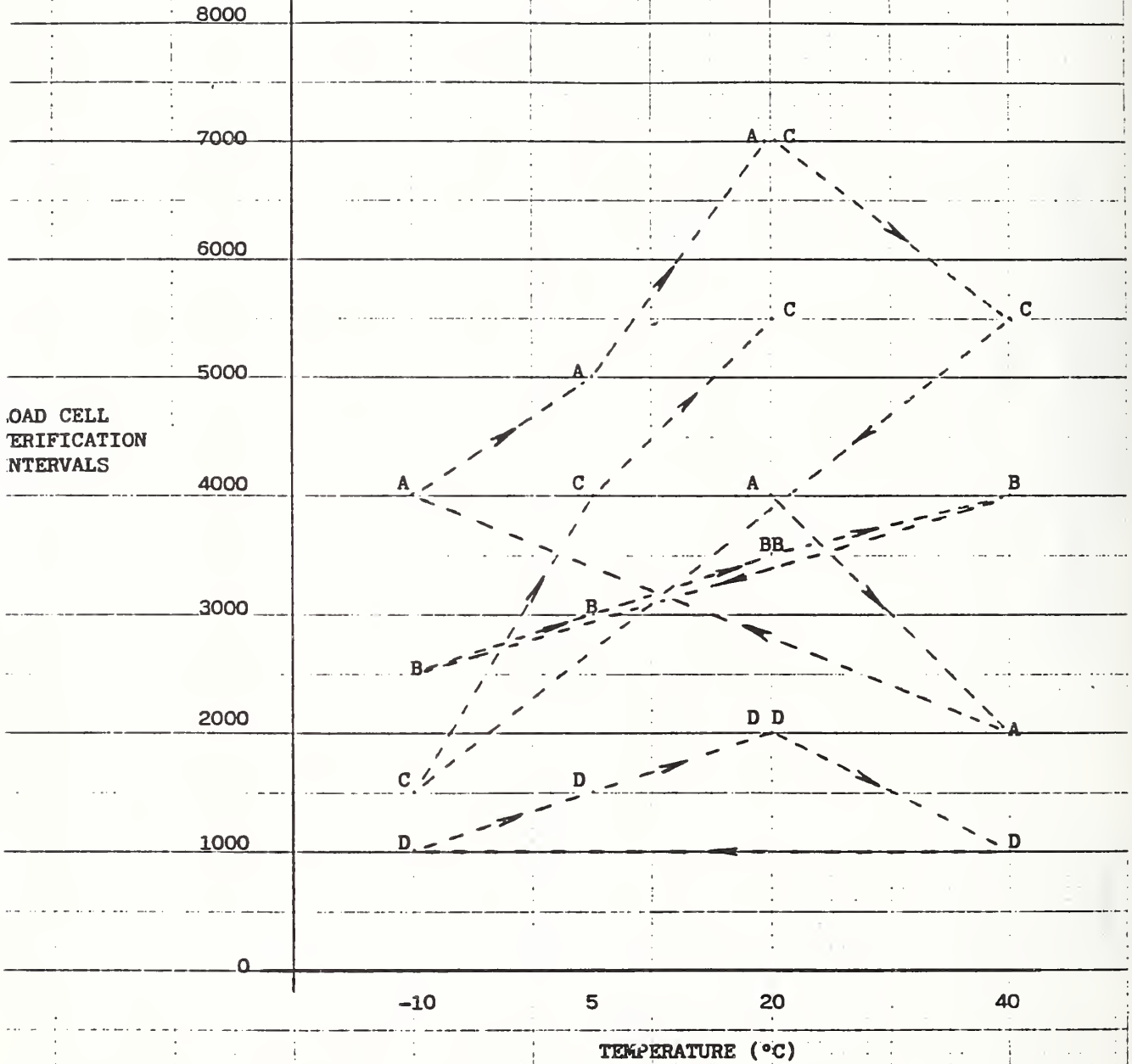

FIGURE 6. NWML ASSESSMENT OF LOAD CELL VERIFICATION INTERVALS FOR EACH SET OF TEST LABORATORY RESULTS

1.5 TONNE LOAD CELL



Key: A - Lab 3
 B - Lab 4
 C - Lab 5
 D - Pivot

APPENDIX D
PIVOT LABORATORY REPORT
500 kg LOAD CELL



**VERIFICATION TESTS OF A 500-KILOGRAM LOAD CELL
AT FIVE NATIONAL LABORATORIES**

1. INTRODUCTION

A 500 kg capacity, single-cantilever beam-type load cell was tested by five national laboratories. The participating laboratories and the dates of test completion were:

- a. National Bureau of Standards (NBS), United States of America (November, 1985). The test was performed under the supervision of NBS by the Toledo Scale laboratory (Columbus, Ohio).
- b. National Standards Commission (NSC), Australia (May, 1986).
- c. National Weights and Measures Laboratory (NWML), United Kingdom (August, 1986). The test was performed under the supervision of NWML by the Avery, Ltd. laboratory (Tamebridge).
- d. Physikalisch-Technische Bundesanstalt (PTB), Federal Republic of Germany (May, 1987).
- e. Van Swinden Laboratory (VSL), the Netherlands (September, 1987).

The load cell was shipped to each laboratory with a compression loading button attached but without a base block. Therefore, each laboratory provided the base block used in the test it performed.

To check the long-term stability of the load cell, zero-load output and full-scale output at room temperature were measured by NBS both before and after the load cell was tested by the other four laboratories. The measured values, given in Table 1, show that the load cell remained stable during the two years of the testing program.

TABLE 1. ZERO-LOAD OUTPUT AND FULL-SCALE OUTPUT AT NBS

YEAR	LOAD, kg	OUTPUT, mV/V	TEMPERATURE, ° C
1985	0	-0.03815	23.0
1987	0	-0.03982	22.9
1985	500	1.99764	21.4
1987	500	1.99850	23.0

2. TEST RESULTS

The test results from the five laboratories were normalized to a common test load unit, to load cell capacity, and to the target test temperatures by using the procedures outlined below.

- a. Comparison Mass Unit - Test loads were recorded in either mass or force units. When loads were recorded in mass units, the reported data were first converted to force units by the use of local gravity, weight density, and estimated air density. The resulting test loads were then converted to a common "comparison mass unit" that is proportional to the applied force and that is defined by the following set of gravity and density values: $g_c = 9.801 \text{ m/s}^2$, $D_c = 8.0 \text{ g/cm}^3$, $d_c = 0.0012 \text{ g/cm}^3$.
- b. Test Loading Range - In some cases, due to the limitations of the loading machine, the test loading range did not equal the load cell capacity. In the analysis of load cycle test data, the computed errors were referenced to load cell capacity. Minimum dead load output return and creep test data were normalized by multiplying the measured results by the ratio of load cell capacity to test loading range.
- c. Test Temperature - In some cases, the measured test temperature departed slightly from the target test temperature. The load cycle test data, other than the 20 °C data, were linearly scaled to the target temperature by using the results from the initial test at 20 °C as the reference. Minimum dead load output return and creep test data were linearly interpolated or extrapolated to the high and low target temperatures.

The test results from all five laboratories were analyzed for 3500 load cell verification intervals. The value of the minimum load cell verification interval (v_{\min}) was set equal to the load cell verification interval (v).

2.1. Mean Combined Error

Plots of the mean combined errors due to nonlinearity, hysteresis, and temperature effect on sensitivity are given in Figs. 1 through 5 as a function of laboratory. The nominal test temperatures are indicated by the plotted data points as follows:

- 1 - 20°C (initial test)
- 2 - 40°C
- 3 - -10°C
- 4 - 5°C
- 5 - 20°C (repeat test)

The general patterns of the data from all five laboratories are reasonably similar. Also, the computed load cell errors at the high and the low temperatures are generally higher than those computed at the other temperatures. Plots of the mean combined errors for only the high and low temperature tests at all five laboratories are given in Figs. 6 and 7, respectively. These plots show reasonably good agreement at the high temperature (within about 0.45v) and even better agreement at the low temperature (within about 0.3v).

Since test loads did not coincide precisely with the steps in the error bounds and with load cell capacity, estimates of the errors that might have occurred at these critical load levels were interpolated (or extrapolated at 3500v) relative to the mean errors resulting from adjacent test loads. Each of these interpolated error estimates, along with each of the mean errors, was compared with the maximum permissible error at the corresponding load level. The critical maximum ratio of either type of combined error (measured or interpolated) to the maximum permissible error is given in the first row of Table 2 for each laboratory. In all five cases the critical maximum ratio was produced at or near capacity load, in three cases at the high temperature (Fig. 6) and in two cases at the low temperature (Fig. 7).

2.2. Repeatability Error

Each repeatability error was divided by the maximum permissible error at the corresponding load level. The resulting critical maximum ratio is given in the second row of Table 2 for each laboratory. In all five cases the critical maximum ratio was produced at a load of less than 500v. At four laboratories the maximum repeatability error was well within the permissible error bounds. Laboratory 1 only exceeded the maximum permissible error by 2 counts (in 100,000) in one reading and by 1 count in another reading.

2.3. Temperature Effect on Minimum Dead Load Output

A plot of minimum dead load output versus temperature for four of the laboratories is given in Fig. 8. In this plot, test data recorded at consecutive test temperatures are connected by straight lines. The maximum slopes of the straight lines were divided by the maximum permissible value of the temperature effect and the resulting critical maximum ratio for each laboratory is given in the third row of Table 2.

TABLE 2. CRITICAL ERROR RATIO

CHARACTERISTIC	LABORATORY					MEAN	STRD. DEV.
	1	2	3	4	5		
Mean combined error	0.745	0.595	0.633	0.772	0.862	0.721	0.108
Repeatability error	1.102	0.115	0.350	0.700	0.451	N/A	N/A
Temp. effect on min. output	0.382	1.010	0.629	<u>0.651</u> ¹	0.653	0.668	0.259
Min. output return	<u>1.331</u> ²	0.83 ³	0.893	0.910	0.697	0.832	0.097
Creep	-----	0.42 ³	0.448	0.405	0.320	0.398	0.055
Max. critical ratio	1.331	1.010	0.893	0.910	0.862	N/A	N/A

1. Not included in computation of mean. Computed from outputs before and after temperature steps rather than from outputs during load cycle tests.
2. Not included in computation of mean. Load cell not tested at 5 °C.
3. Computed from graphical rather than digital data.

The Laboratory 4 results are not included in Fig. 8 because they were computed from outputs recorded immediately before and after each temperature step, rather than from outputs recorded during the load cycle tests. Nevertheless, the computed critical maximum ratio given in Table 2 for Laboratory 4 is in good agreement with the results from the other laboratories.

An alternative view of the same minimum dead load output data is given in Fig. 9. This plot shows that, except for the one low point at the low test temperature, the data from the four laboratories are reasonably clustered at each test temperature. However, the low point at 5°C in combination with the high point at -10°C give a critical maximum slope for Laboratory 2 that slightly exceeds the permissible value. This illustrates the sensitivity of this result to small differences in the minimum dead load output readings. The curve drawn through the data is not a least-squares fitted curve; it is only intended to illustrate that all of these data, including the low point at the low test temperature, could roughly be approximated by a single-valued function of temperature.

The minimum load cell verification interval (v_{\min}) of this load cell would be limited by the temperature effect on minimum dead load output. In computing the critical error ratios given in the third row of Table 2, the value of v_{\min} was arbitrarily set equal to v . Therefore, the tabulated critical error ratios are the ratios of the minimum value of v_{\min} for which the load cell could be classified to the verification interval v (for 3500v).

2.4. Minimum Dead Load Output Return

A plot of minimum dead load output return versus temperature for the five laboratories is given in Fig. 10. Laboratory 1 did not perform this test at 5°C; therefore, for this laboratory, the results from tests at approximately -10°C and 20°C are connected by a straight line. The maximum value of the output return was divided by the maximum permissible value and the resulting critical maximum ratio is given in the fourth row of Table 2 for each laboratory.

Two different patterns are suggested by the data plotted in Fig. 10, one by the data from Laboratories 1 and 4 and one by the data from Laboratories 2, 3, and 5. From this sample of data, it is not clear which pattern better represents the true characteristic of the load cell.

2.5. Creep

A plot of four-hour creep versus temperature for the four laboratories that performed the creep test is given in Fig. 11. There is a clear similarity between the patterns of these creep

data and the corresponding minimum dead load output return data plotted in Fig. 10. This might have been expected, since creep and creep recovery are related phenomena. The critical maximum creep values at 40°C are in good agreement. The creep versus time results plotted in Fig. 12 are also in generally good agreement. For each laboratory, the maximum four-hour creep value was divided by the maximum permissible value and the resulting critical maximum ratio is given in the fifth row of Table 2.

2.6. Maximum Critical Ratio

The maximum critical value of the five performance characteristic ratios is given in the sixth row of Table 2 for each laboratory. In three cases the critical characteristic is the minimum dead load output return, in one case it is the temperature effect on minimum dead load output, and in one case it is the combined error. Based on a direct application of these numerical results, in two cases the load cell would qualify for 3500v, in one case it would barely qualify for 4000v, in one case it would fall short of qualifying for 3500v (by only 1 percent), and in one case it would qualify for 2500v. In the latter case (Laboratory 1) the load cell would also qualify for 3500v, except for three readings that exceeded the repeatability error limit by one or two counts (in 100,000) and except for the minimum dead load output return results that exceeded the error limit by 5 counts at 20°C and by one count at 40°C (see Fig. 10). Although Laboratory 1 did not perform the creep test, it is unlikely that this test would have limited the load cell classification.

3. CONCLUSIONS

The test data support the following conclusions:

- a. The load cell remained stable throughout the two year testing program (see Table 1).
- b. The load cycle test data from the five laboratories were in reasonably good agreement, particularly at the critical high and low test temperatures (see Figs. 6 and 7).
- c. Only one laboratory had repeatability errors greater than permissible (for 3500v). Those errors exceeded the limit at only two test loads by only one or two counts in 100,000.
- d. The minimum dead load output readings were in reasonably good agreement. Only one laboratory had a test result that exceeded the permissible limit, and in that case by only about one percent (for 3500v).

- e. There is a clear similarity between the patterns of the creep data and the corresponding minimum dead load output return data when plotted as a function of temperature (see Figs. 10 and 11).

- f. Based on the test results from the five participating laboratories, it is seen that the load cell would qualify in two cases for 3500v, in one case for 4000v, in one case for 3000v, and in one case for 2500v. However, most of the data from all five laboratories is consistent with a classification of 3500v. And, except for differences of only a few counts in several output readings, all five laboratories could have classified the load cell for 3500v.

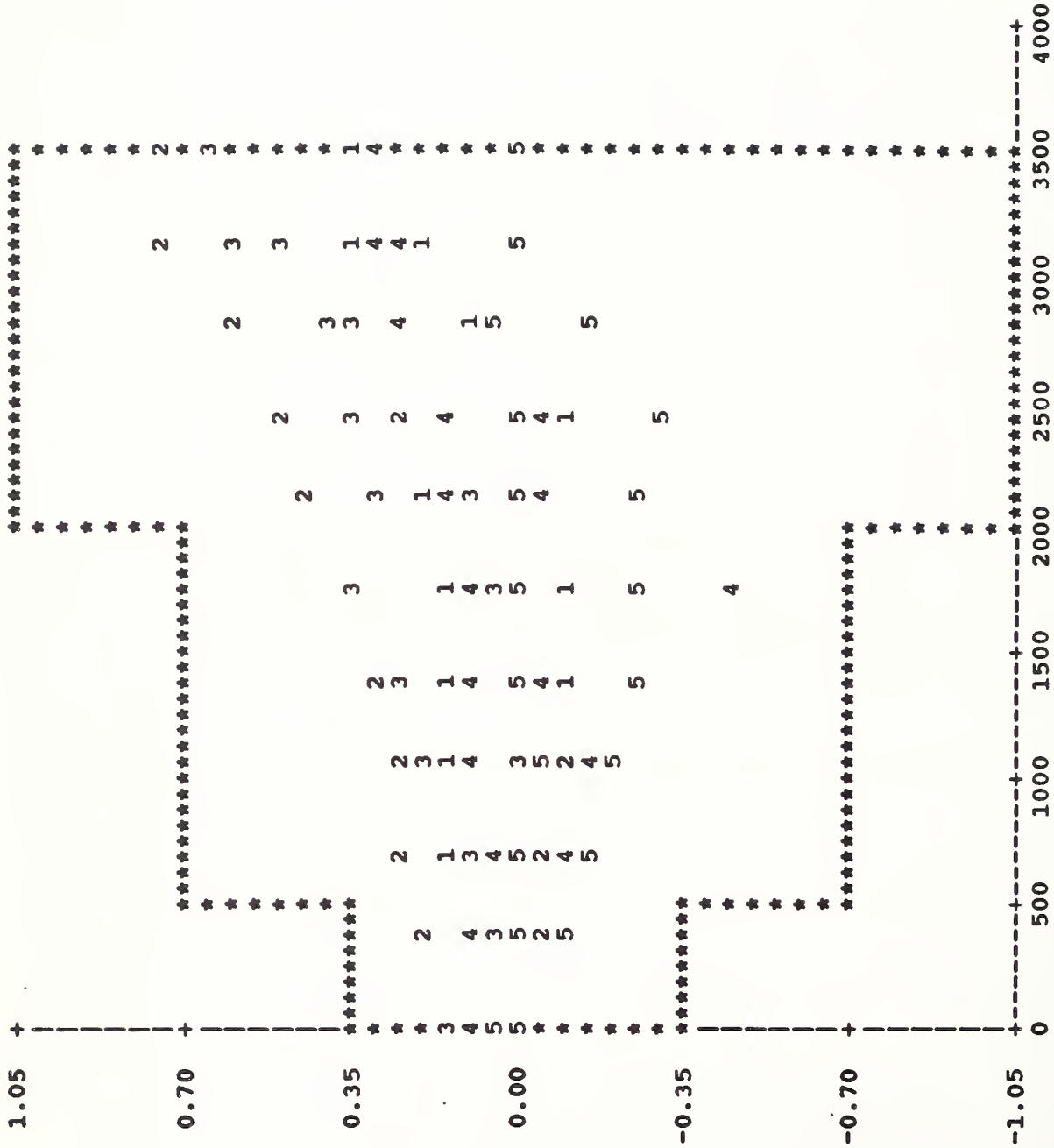

FIGURE 1. Mean combined errors at Laboratory 1.

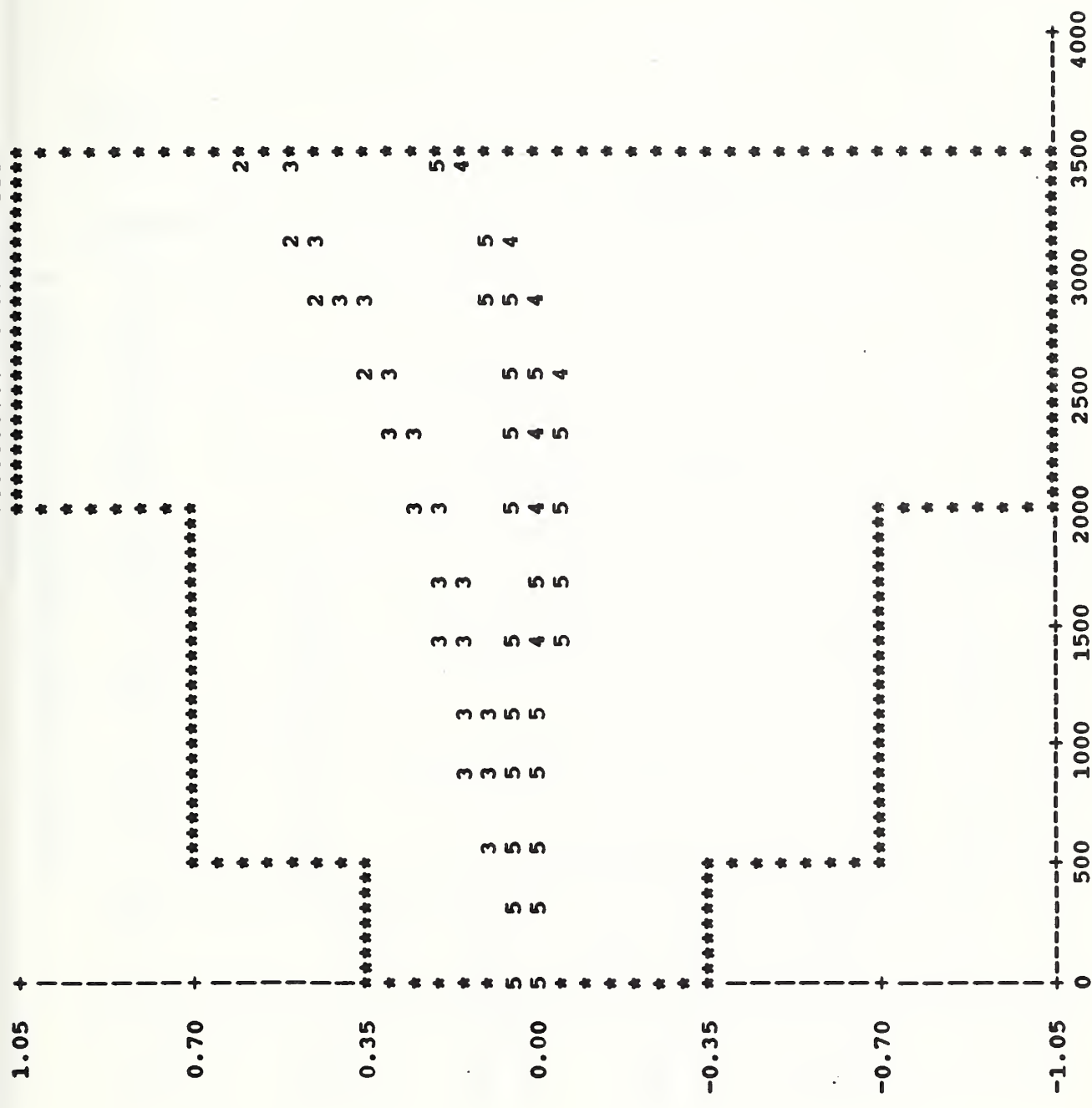

FIGURE 2. Mean combined errors at Laboratory 2.

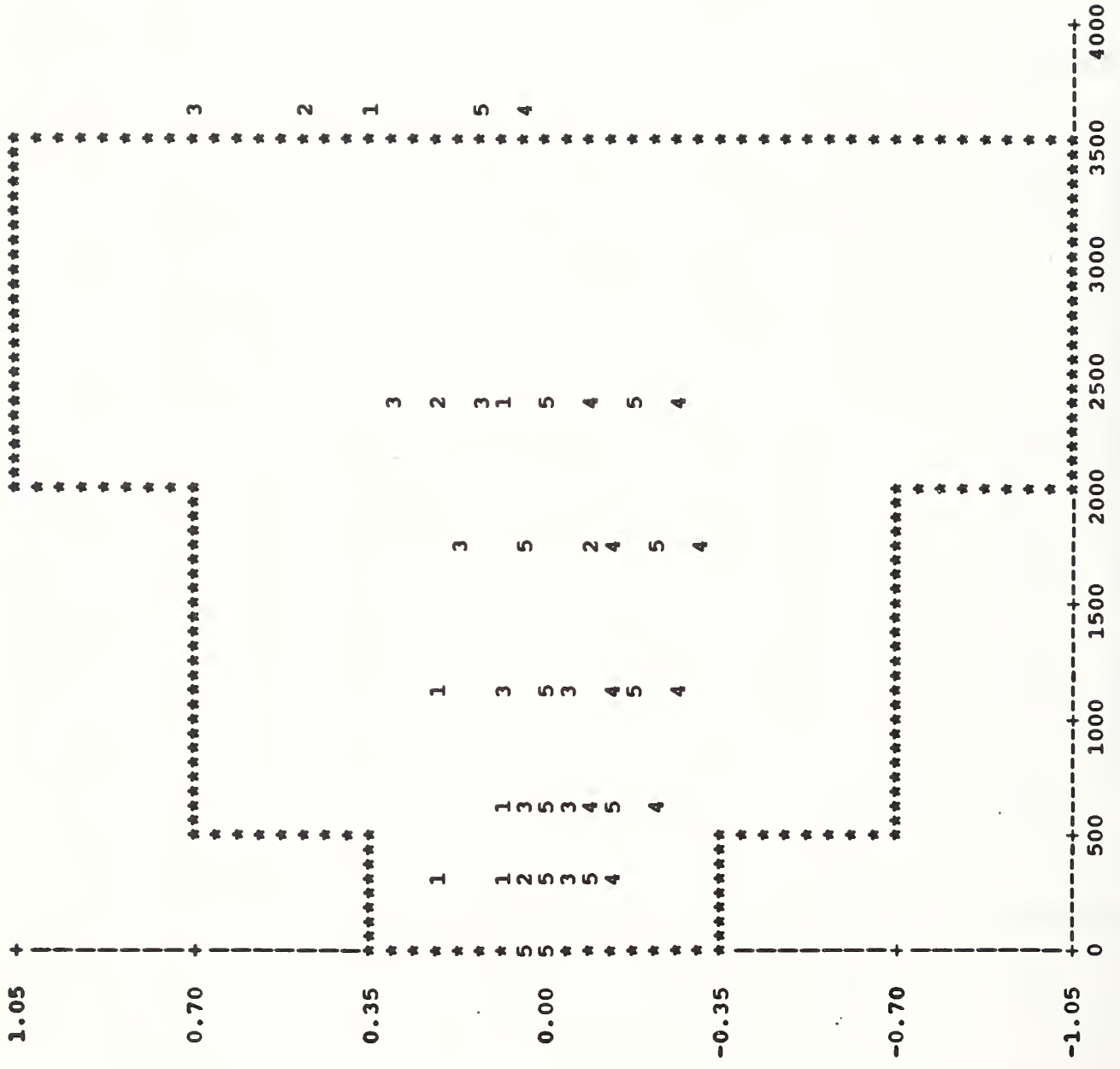

FIGURE 3. Mean combined errors at Laboratory 3.

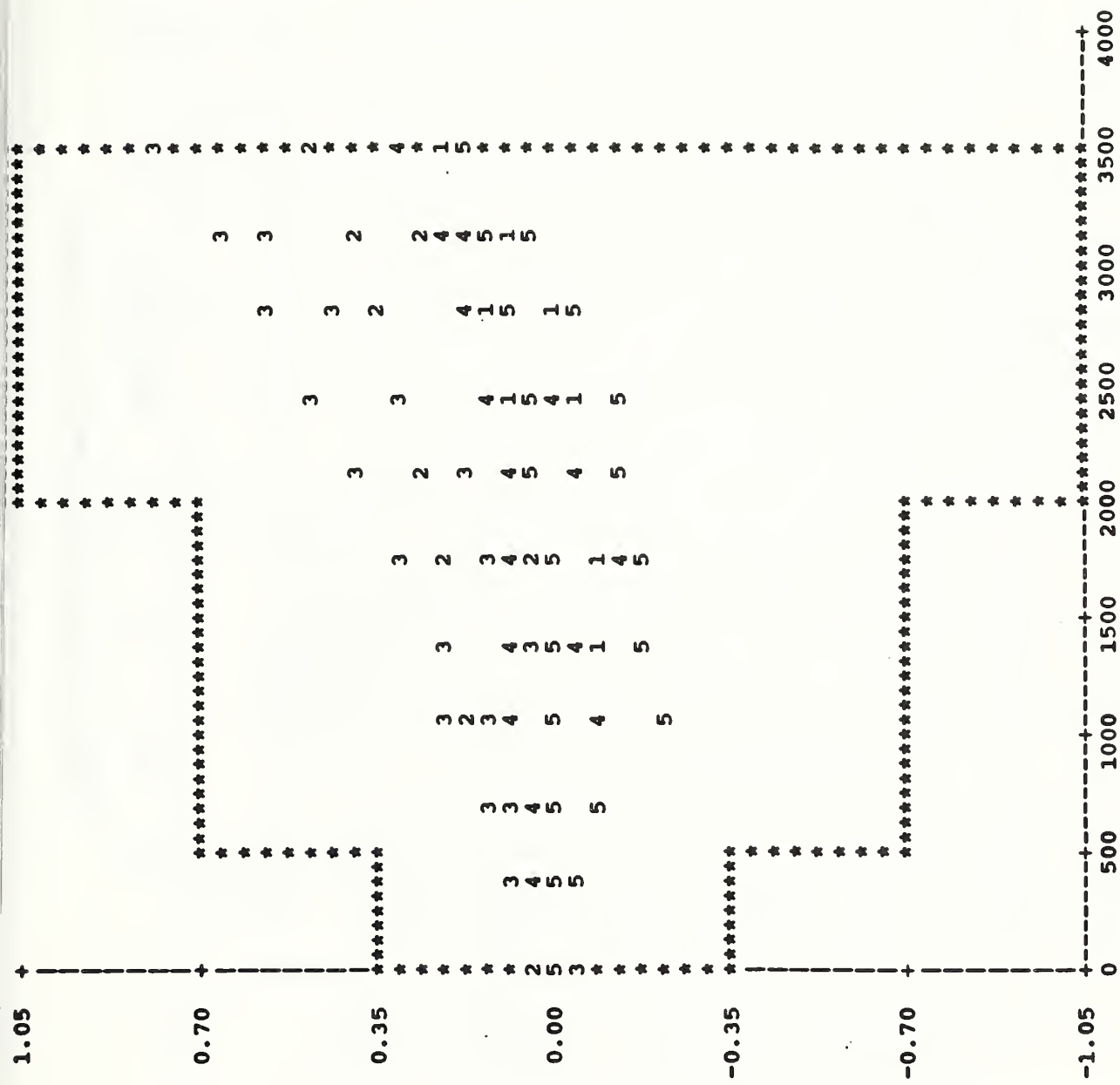

FIGURE 4. Mean combined errors at Laboratory 4.

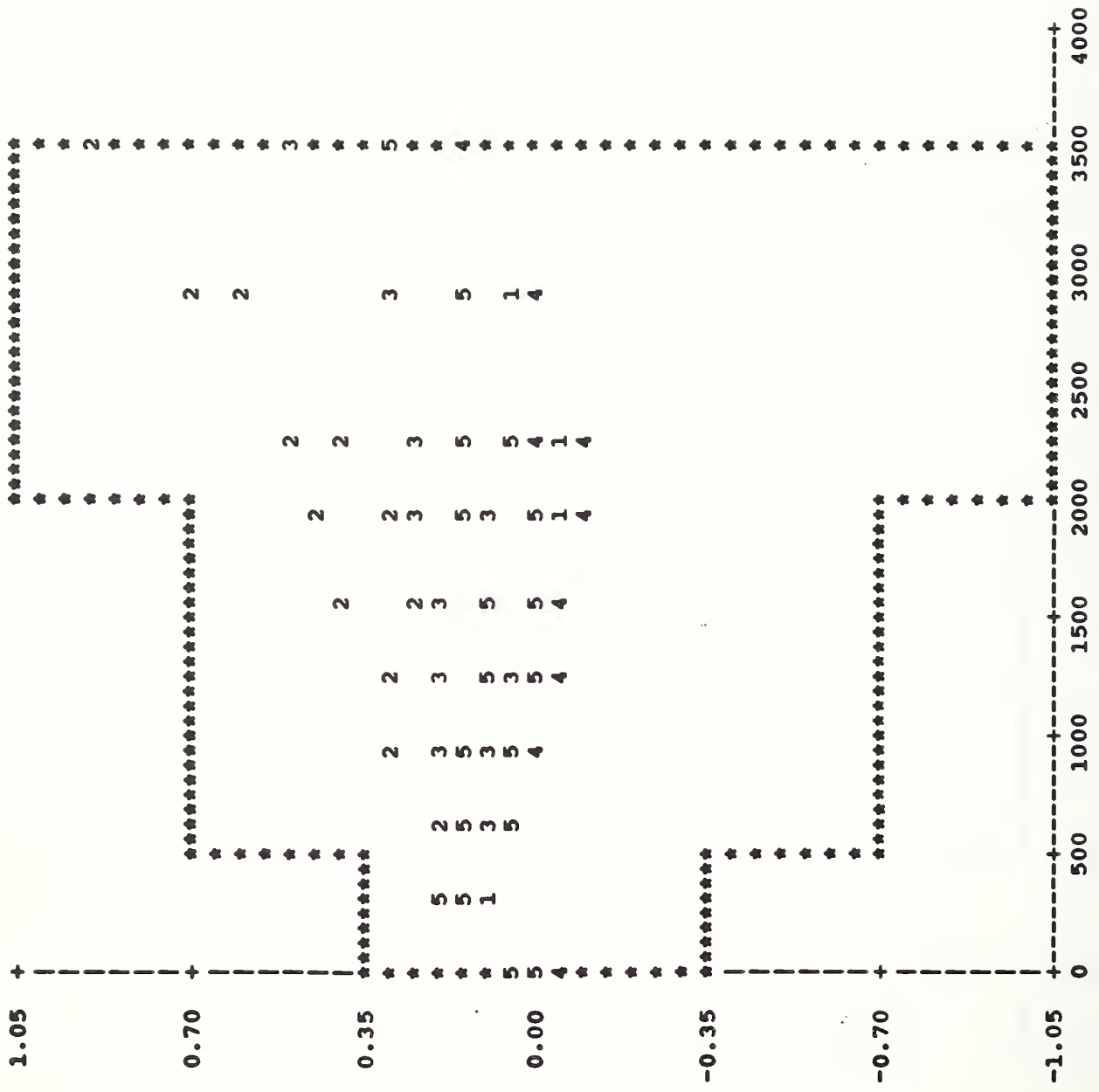

FIGURE 5. Mean combined errors at Laboratory 5.

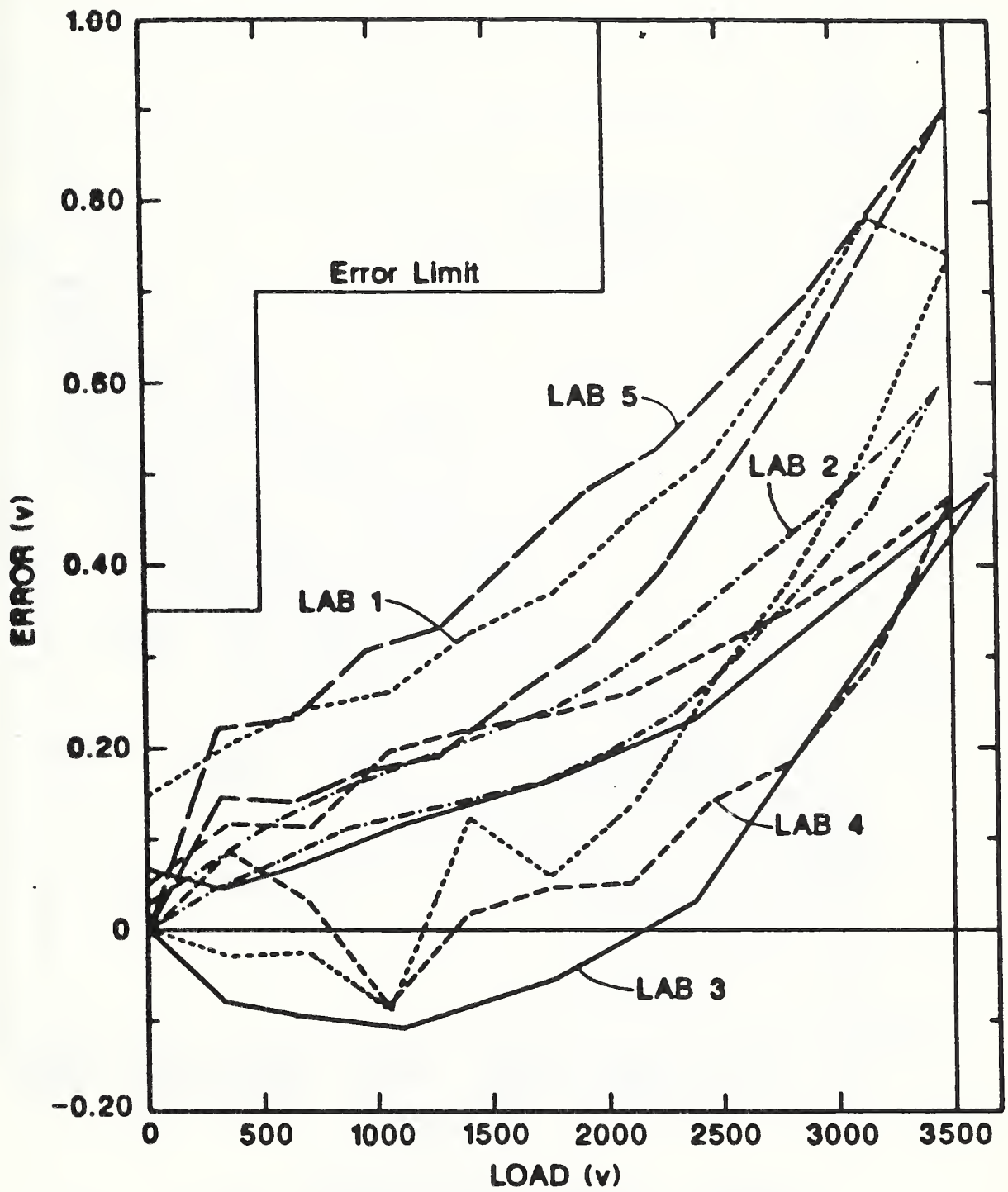

FIGURE 6. Mean combined errors at 40°C.

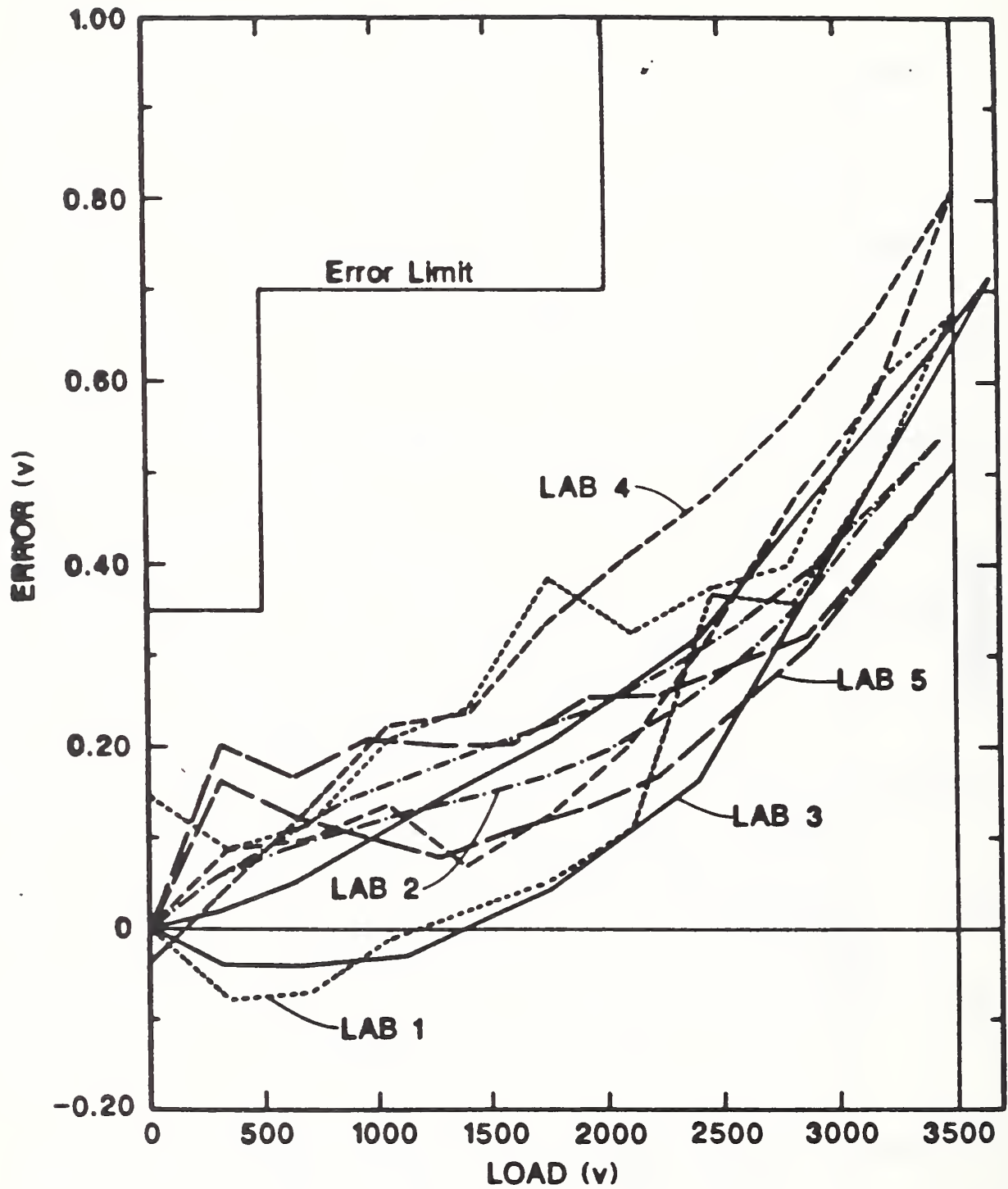

FIGURE 7. Mean combined errors at -10°C .

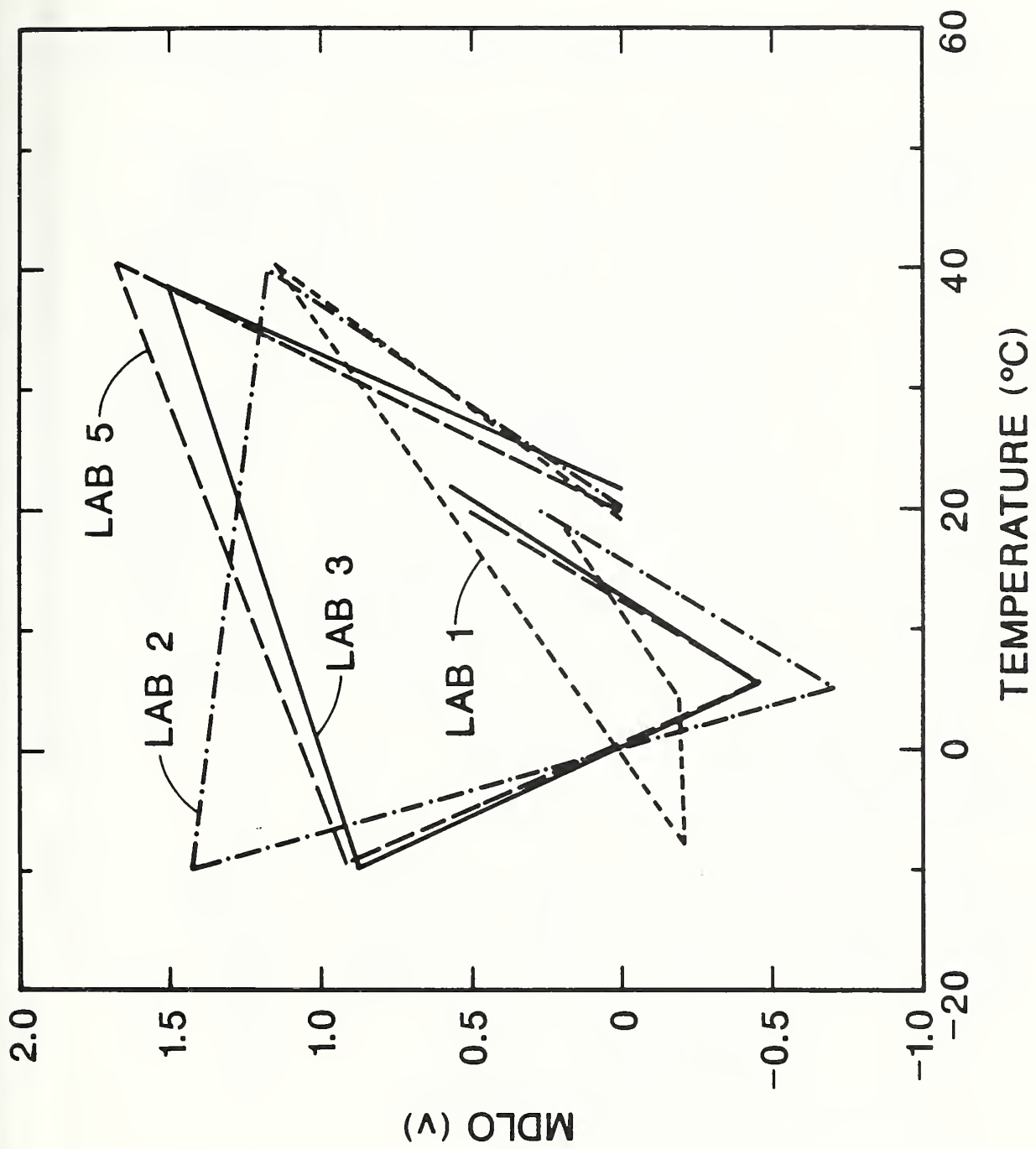

FIGURE 8. Minimum dead load output versus temperature.

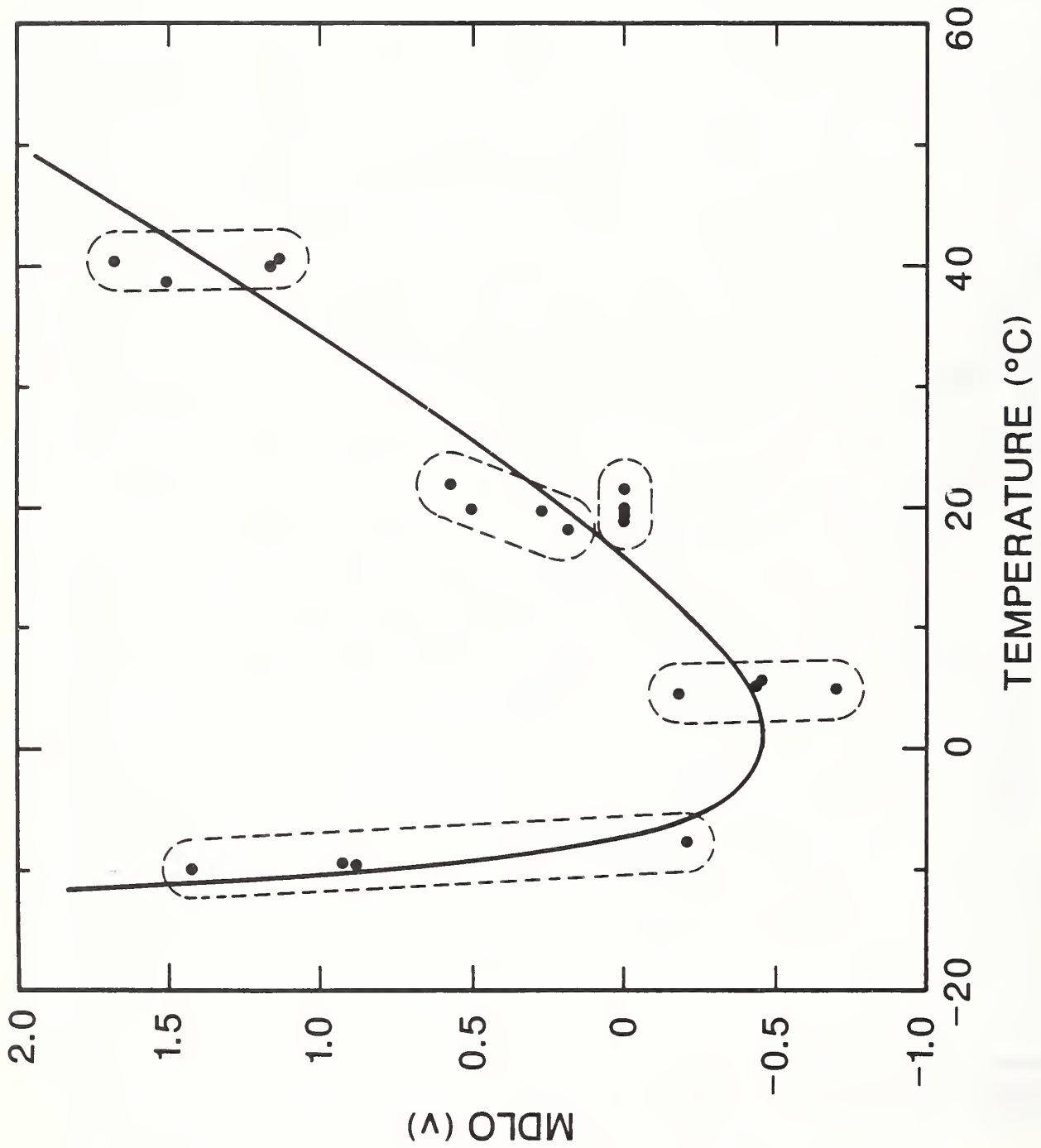

FIGURE 9. Alternative plot of minimum dead load output versus temperature.

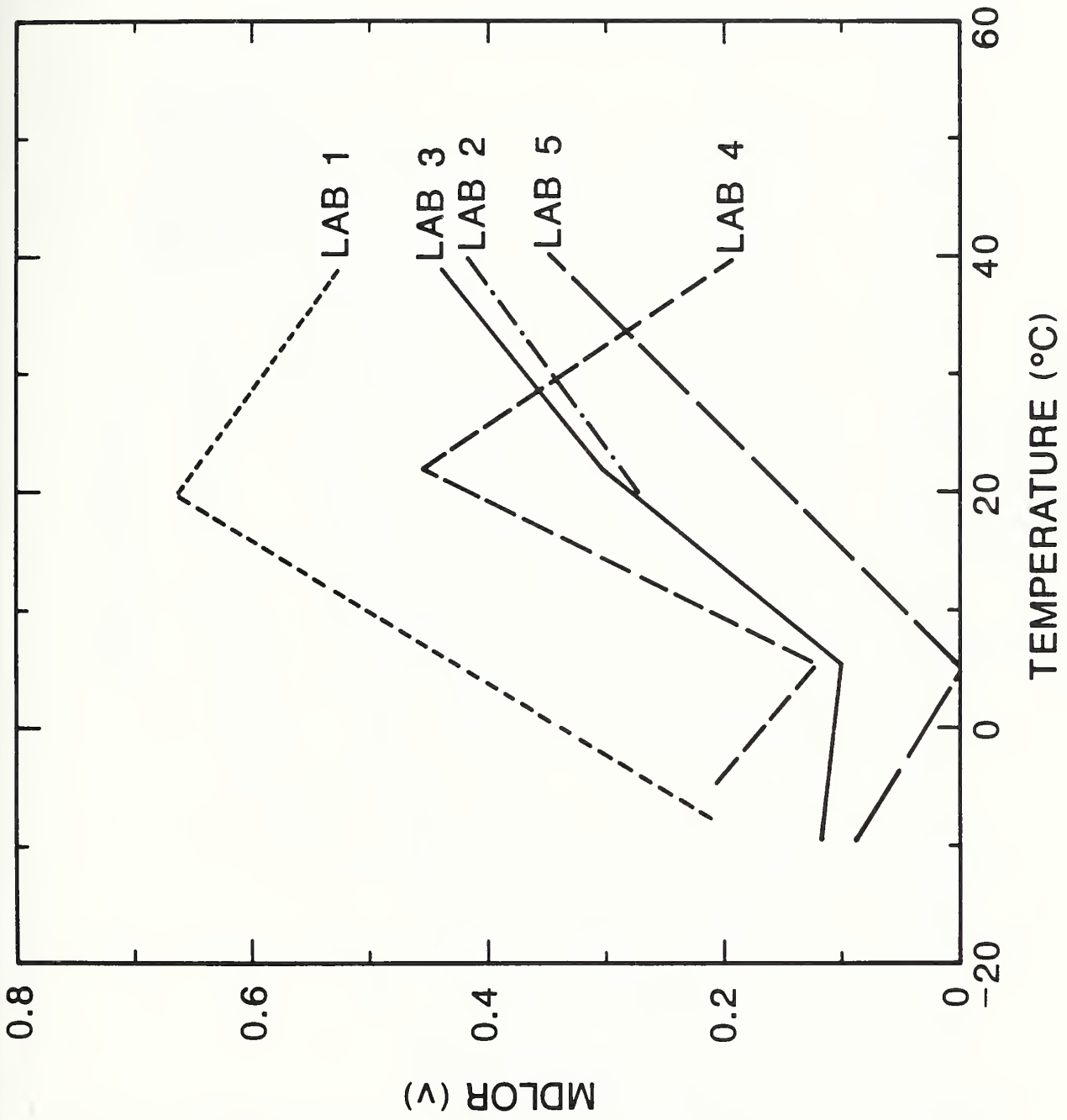

FIGURE 10. Minimum dead load output return versus temperature.

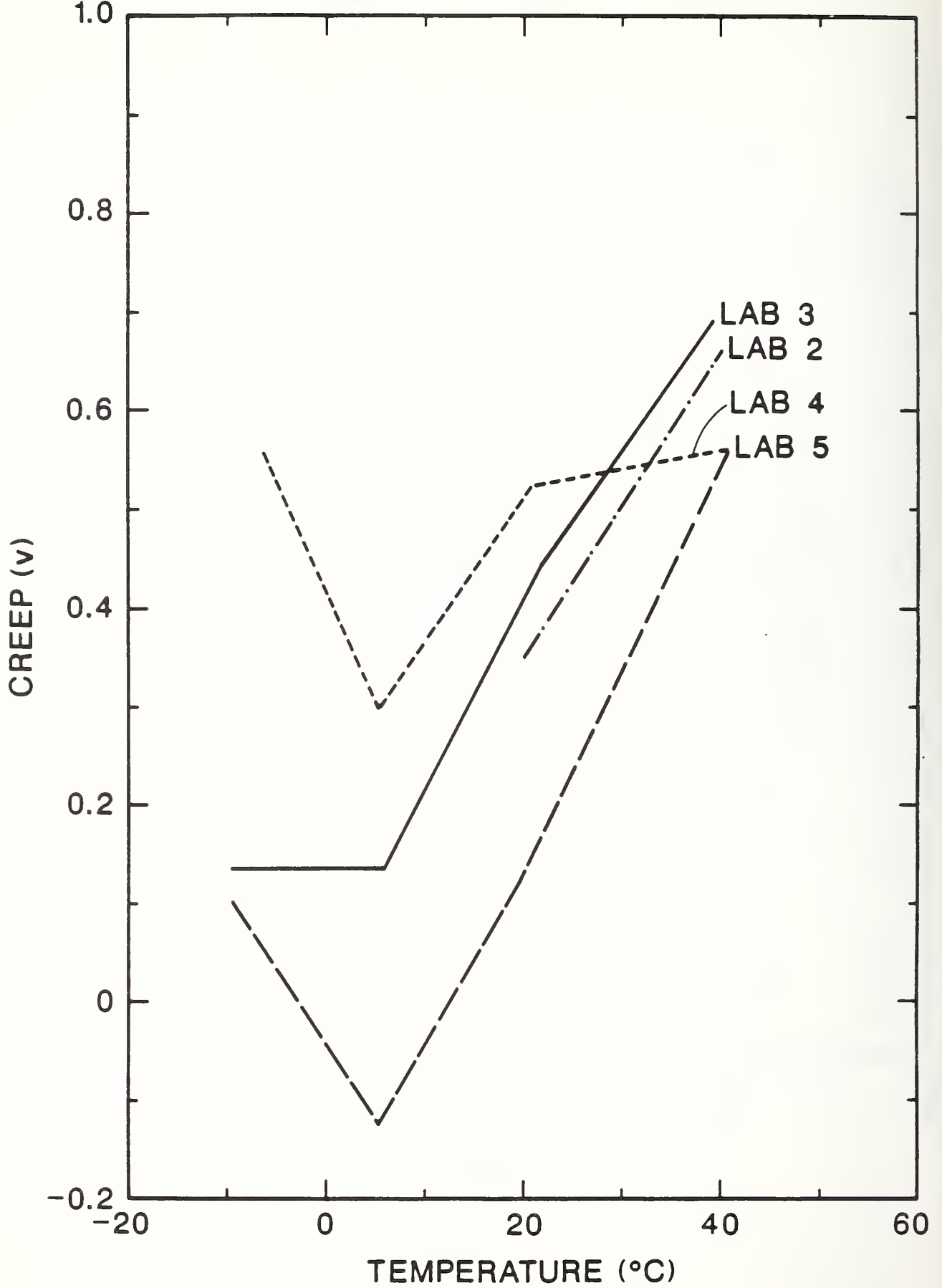

FIGURE 11. Four hour creep versus temperature.

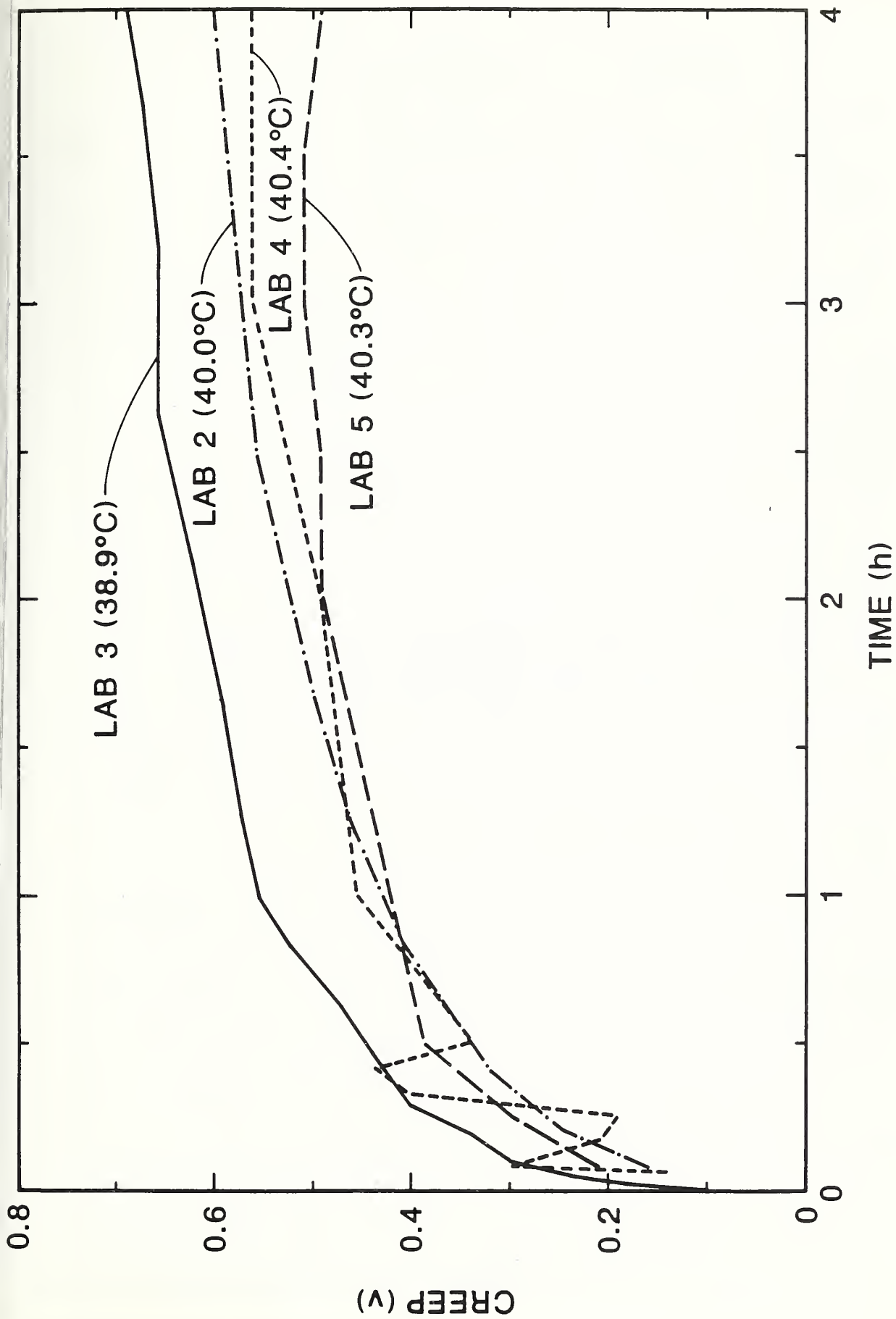

FIGURE 12. Creep versus time.

APPENDIX E
PIVOT LABORATORY REPORT
200 kg AND 18 kg LOAD CELLS

OIML Intercomparison of Load Cells

Report of Results for
18 kg and 200 kg

by C. U. Volkmann, B. Meißner and K. Schulz

1. Introduction

The O I M L - International Recommendation No 60: **Metrological Regulations for LOAD CELLS** has been accepted for the first time in October 1984 at the Seventh International Conference of Legal Metrology.

The IR-60 was created by the SP7/SR8 working group with two international meetings in June 1979 in Paris and in October 1980 in Braunschweig under chair of the United States of America.

To gain experience with the new IR-60 an intercomparison program with six different load cells with capacities from 18 kg up to 25 000 kg was started by:

National Standards Commission (NSC), Australia

Physikalisch-Technische Bundesanstalt (PTB), Federal Republic of Germany

Dienst van het IJkwesen (VSL), the Netherlands

National Weights and Measures Laboratory (NWML), United Kingdom

National Bureau of Standards (NBS), United States of America

Each laboratory was nominated to act as pivot laboratory for at least one of the patterns, PTB being responsible for the 18 kg (single beam) and for the 200 kg (double beam).

2. Test procedure

The test procedure is described in IR-60 No 15. To obtain more adequate results, time intervals for loading and temperature sequence have been fixed as follows.

2.1 Loading sequence

- A Three exercising load applications to maximum load
- B Five minutes rest
- C Three measurement cycles of the load cell output by given loads according IR-60 No 7 (time table) and 15.1.5 to 15.1.10
- D At least one hour rest
- E Test of minimum dead load output return after half an hour load application
- F At least one hour rest
- G Four hour creep test

A to G shall be performed in sequence for each test temperature. If it is more convenient the characteristic C may be gained in one temperature cycle (ABC) with E and G being object of an extra cycle (ADEFG).

2.2 Temperature cycle

Sensitivity and minimum dead load output of a load cell may be influenced by the temperature succession, sequence of the temperatures has been set to 20, 40, -10, 5 and 20 degree centigrade.

3. Presentation of the intercomparison

3.1 The equipment

Load cells, indicators and loading equipment are described by drawings, photos or tables.

3.2 Test results

The allowed limits are fixed in IR-60 No 5 to 10.

3.2.1 Maximum permissible errors

Linearity, hysteresis and temperature effect on sensitivity. The tables show the maximum number of load cell intervals n_{max} , due to the maximum permissible errors, the hysteresis in v^* (verification interval) or ppm and the temperature effects on sensitivity $\{s_m - s_0\}(\delta)$ in ppm.

In the added diagrams the deviation of the output signal from a straight line is shown, using the average output of three measurements for increasing and decreasing load. The straight line is calculated from minimum dead load to 75% load output for increasing load. The diagrams show in addition the repeatability after the temperature cycle and the smoothness of the curves gives an impression of loading errors, indicator errors and load feeding errors.

However not all types of errors can be detected and especially by the averaging smaller errors will be hidden.

3.2.2 Temperature effect on minimum dead load output MDLO(δ)

The values s_0 are shown in ppm in a table, mostly this effect is responsible for the smallest verification interval v_{min} . v_{min} is independent of the

maximum number of load cell intervals n_{max} .

Terms: L_m = maximum capacity, L_o = minimum dead load, δ = temperature,
 S_o = output signal at MDLO, S_m = output signal at L_m ,
 ΔS_o = deviation of S_o , referred $\Delta s_o = \Delta S_o / (S_m - S_o)$

Minimum load cell verification interval caused by temperature variation
$$v_{min}(\delta) = [L_m \cdot \Delta s_o / (\Delta \delta / 5K)] / 0,7$$

variation: measurement of S_o three times ($m=3$) just before and between measurement cycles in accordance to IR-60 No 15.1.6, adveraged for all temperatures ($k=5$).

$$var = \sqrt{1/k \sum_{\delta_i} 1/(m-1) \sum_{\delta=const} (s_o - \bar{s}_o)^2}$$

3.2.3 Minimum dead load output return MDLOR

The time table in IR-60 No 7 has to be met, the results are shown in tables.

3.2.4 Four hour creep

Time table in No 7 has to be met, the results are shown in tables, usually the four hour creep will satisfy the conditions when MDLOR has passed.

3.2.5 Pressure effect on minimum dead load output MDLO(p)

No 10.2 has to be met.

4. Intercomparison using the 18 kg load cell

4.1 The equipment

4.1.1 Strain gage load cell

The load cell under test was a single beam load cell with an integrated lever above the strain gage application. The strain gages are hermetically encapsulated.

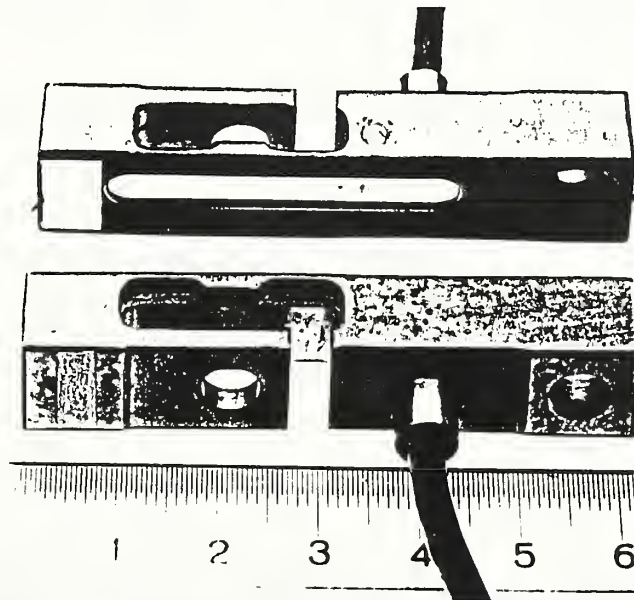

Strain gage load cell 18 kg

The maximum capacity is 18 kg, recommended power supply is 7 volt, bridge resistance is 1000 ohm, material of the cantilever beam is titanium.

To obtain comparable results the load cell was provided with a mounting block and a socket with a steel ball.

Further the equipment was supplied with a symmetric loading shakel.

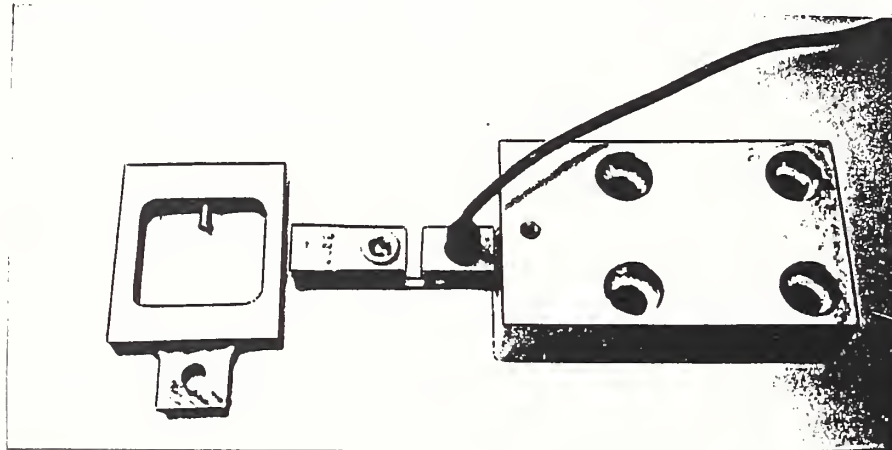

Load cell with mounting device and shakel

4.1.2 Used indicators

PTB	DMP 39 S6	H B M	7 V	225 Hz	SN	128
NWML	Mod: 1071	Datron	7 V	DC	SN	15165
NSC	DMP 39 S	H B M	15 V	225 Hz	SN	114
NBS	Mod: 101-C	DJ-Instrum.	7 V	DC	SN	15279
VSL	DMP 39	H B M		225 Hz		

4.1.3 Used loading equipments, measuring ranges and dead loads

PTB	*	18	kg	704	g
NWML	*	16	kg	920	g
NSC	*	18	kg	750	g
NBS	*	40,61	lb (18,42 kg)	84	g
VSL	*	18	kg	-	

* All laboratories tested by applying weights by hand.

4.2 Test results

4.2.1 Maximum permissible Errors

The results are shown in the diagrams page 11 to 17. All diagrams are fitted with the maximum permissible load cell errors for $n = 6000$.

Linearity, hysteresis and temperature effect on sensitivity

	n* _{max}	hysteresis v*	ppm	{s _m -s _o } (δ) ppm/10K	notes limiting characteristics
LAB 2	6700	0,10	16	+39'	max. load -10°C, lower limit 20°C to -10°C
LAB 5	6000	0,29	48	+43'	like LAB 2
LAB 4	4700	0,23	49	-44"	lower limit -10°C pt 500 20°C to 40°C
LAB 3	9200	0,10	11	+25'	like LAB 2
LAB 1	7700	0,29	38	+40'	like LAB 2
PIVOT 2	5200	0,07	10	+49'	like LAB 2
PIVOT	3800	PIVOT 2 datas referred to LAB 2 measurement			

4.2.2 Temperature effects on minimum dead load output: MDLO(δ) / ppm

Temperature	20°C	-40°C	-10°C	5°C	20°C	var	notes test load	v _{min}
LAB 2	0	-170	-150	-60	-20	6	18 kg	1,1 g
LAB 5	0	-210 42,4°C	-180 -9,2°C	-105	-95	16	16 kg achieved temperature	1,2 g
LAB 4	- 21,2°C	- 40,9°C	- -2,8°C	- 5,5°C	- 21,4°C	-	cancelled, chang. proced. achieved temperature	
LAB 3	0 20,7°C	-260 42°C	-10 -8,5°C	+30	-40 20,7°C	10	18,4 kg achieved temperature	1,6 g
LAB 1	0 19,5°C	-280	+90 -9°C	+165	0 +35	48	18 kg achieved temperature changed sequence	1,8 g
PIVOT 2	0	-160	-130	+30	+40	6	18 kg	1,4 g

4.2.3 Minimum dead load output return: MDLOR / ppm

Temperature	20°C	40°C	-10°C	5°C	20°C	n* _{max}
LAB 2	<+5	-50	+15	+10	<+5	10000
LAB 5	-23	-120	-10	-140	-45	3500
LAB 4	-35	-80	-20	-35	+30	6300
LAB 3	+30	-40	+10	+20	-	12500
LAB 1	+10	-155	+45	-	-	3200

4.2.4 4 hour creep / ppm

Temperature	20°C	40°C	-10°C	5°C	20°C	n''_{max}
LAB 2	-	-90	+50	+30	-40	11500
LAB 5	-45	-270	+60	+30	-60	3900
LAB 4	-95	-80	-170	-95	-65	6200
LAB 3	+10	-115	+30	+30	-	9100
LAB 1	-	-	-	-	-	-

4.2.5 Pressure effect

Due to the design no essential effect has to be expected at all. LAB 5 and LAB 4 found a very small effect of about 4 to 5 ppm/kPa although the dispersions had the same amounts. These variations can even be caused by a temperature change of 0.3 K caused by the variation of air pressure. Taking care of these effects PTB didn't find any pressure influence.

4.2.6 Résumé of single results for the 18 kg load cell

The maximum number of load cell intervals is presented in steps of 500.

	n_{max}	v_{min}	notes
LAB 2	6500	1,1 g	
LAB 5	3500	1,2 g	MDLOR, creep
LAB 4	4500	-	
LAB 3	9000	1,6 g	
LAB 1	3000	1,8 g	MDLOR
PIVOT 2	5000	1,4 g	

PIVOT 2 results referred to LAB 2 measurement will not be considered here as all other measurements do not deal with this effect. It has been noticed, that the basis plate changed some little its leveling, furthermore an aging can't be excluded.

5. Intercomparison using the 200 kg load cell

5.1 The equipment

5.1.1 Strain gage loads cell

The load cell under test was a double bending beam load cell with a metallic bellow for the hermetically encapsulation of the strain gages.

The maximum capacity is 200 kg, recommended power supply is 10 volt, bridge resistance is 350 ohm, material of the cantilever beam is stainless steel.

No further equipment has been necessary for circulation.

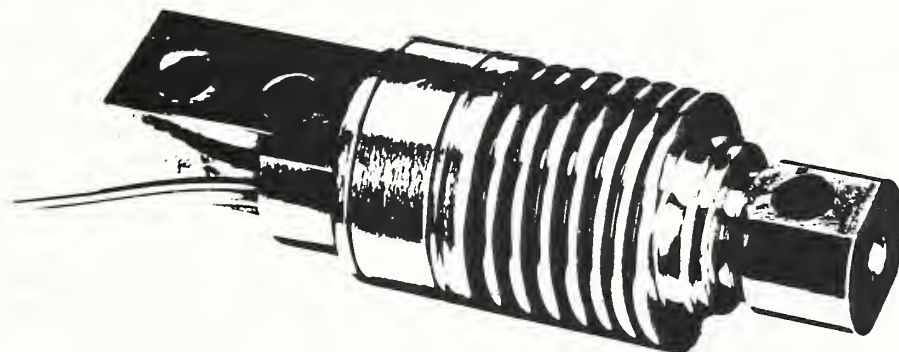

Strain gage load cell 200 kg

5.1.2 Used indicators

P T B	DMP 39S6	H B M	10 V	225 Hz	SN 128
	(DK 37A	H B M	5 V	225 Hz	SN 433)*
N W M L	Mod:1071	Datron	10 V DC		SN 15 165
N B S	Mod:8132	Toledo	$\pm 7,5V$	50% Duty Cy	218Hz SN 2 150 847
N S C	Mod:8132	Toledo	10 V DC	gated 225 Hz	SN 405 6869-4
V S L	Mod:350	Servo Balans	10 V DC		SN 06 683 E

* used for creep measurement and pre measurement

5.1.3 Used loading equipments, measuring ranges and dead loads

P T B	PTB 1.13	Deadweight, 4 kN stack	2 kN (203,82 kg)	4,5 kg
N W M L	Avery	Deadweight 71N59, tare equipment	400 lb (181,44 kg)	0 lb
N B S		Deadweight, 2400 lb	450 lb (204,12 kg)	50 lb
N S C	NSC	Lever 2:1, 500 kg	200 kg	10 kg
V S L	VSL	machine, 550 kg	200 kg	0,2 kg

5.2 Test results

5.2.1 Maximum permissible error

The results are shown in the diagrams page 18 to 24. All diagrams are fitted with the maximum permissible load cell errors for $n = 3000$.

Linearity, hysteresis and temperature effect on sensitivity

	n^*_{max}	hysteresis v*	ppm	$\{s_m - s_0\} (\delta)$ ppm/10K	notes limiting characteristics {power supply}
LAB 2	3000	0,45	150	-60	decreasing load -10°C pt 2000 upper limit {10V AC 225Hz}
LAB 5) ¹	2500	0,34	135	-40	20 to 40°C, otherwise smaller, increasing load +40°C pt 500 lower limit {10V DC} ?
LAB 4	3000	0,43	143	-80	like LAB 2 {±7,5V 218Hz}
LAB 3	4500	0,75	167	±20	like LAB 5, but -7°C {10V gated DC}
LAB 1	2000	0,40	200	-75	like LAB 2 {10V DC}
PIVOT 2	2500	0,43	170	-75	like LAB 2 {10V AC 225Hz}
PIVOT"0"	8000	1,20	155	-40	like LAB 5 {5V AC 225Hz}

)¹ gained on 2nd and 3rd load cycle

PIVOT"0" is measured with a different indicator just before the intercomparison for purpose of pattern approval. PTB accepted only $n_{max} = 3000$ because of the hysteresis. The temperature effect on sensitivity is dependend on the power supply except the results of LAB 5.

5.2.2 Temperature effects on minimum dead load output: MDLO (δ) / ppm

Temperature	20°C	40°C	-10°C	5°C	20°C	var	notes test load	v_{min}
LAB 2	0	+325	-265	-180	-20	11	203,8 kg	24 g
LAB 5	0	+280	-180	+5	0	194	181,4 kg	18 g
	0	+510	-260	-70	-20	37		33 g) ¹
LAB 3	0	+450	-510	-255	-5	5	204,1 kg	33 g
	20,6°C		-9,2°C	7,9°C	20,6°C		achieved temperature	
LAB 4		+240	-190	-105	-90		changed procedure	
	0	+215	-220	-120			200 kg	17 g
			-6,8°C				achieved temperature	
LAB 1	0	+170	-120	-80	-30	9	200 kg	15 g
	21,3°C	37,4°C	-9,0°C	6,5°C	20,5°C		achieved temperature	
	1	2	4	3	5		changed sequence	
PIVOT 2	0	+375	-265	-170	+10	12	203,8 kg	27 g

)¹ gained on MDLO before 2nd and 3rd load cycle, var smaller

5.2.3 Minimum dead load output return: MDLOR / ppm

Temperature	20°C	40°C	-10°C	5°C	20°C	notes initial reading	n'' _{max}
LAB 2	-95	-100	-90	-110	-105	time 19 s	4500
LAB 5	-70	+330	-140	-225	-80	time 10 s	1500
LAB 3	-70	-70	-70	-90	-	time 31 s	5600
LAB 4	-50	-80	-105	-55	-50		4800
LAB 1	+80	+330	+210	changed procedure, without exercising, separate measurement			1500

5.2.4 4 hour creep / ppm

Temperature	20°C	40°C	-10°C	5°C	20°C	notes initial reading	n'' _{max}
LAB 2	4 hour not measured; 1/2 hour creep with MDLOR test: creep in last 15 minutes smaller than 10 ppm						-
LAB 5	-60	-40	-320	-210	-60	time 10 s	3300
LAB 3	-90	-105	-80	-90	-	time 30 s	10000
LAB 4	-115	-115	-205	-125	-135	temperature instable -6,3 to 0,2°C	5100
LAB 1	not measured, short final date						-

5.2.5 Pressure effect

Due to the design of the load cell no essential effect has to be expected at all. The supplied raw datas from LAB 5 and LAB 4 don't show any pressure influence.

5.2.6 Résumé of single results for the 200 kg load cell

The maximum number of load cell intervals is presented in steps of 500.

	n _{max}	v _{min}	notes
LAB 2	3000	24 g	
LAB 5	1500	33 g	MDLOR
LAB 3	3000	33 g	
LAB 4	4500	17 g	
LAB 1	2000(1500)	15 g	MDLOR
PIVOT 2	2500	27 g	

6. Concluding Observations

A lot of the single results are in good agreement to another. However the overall results don't allow the general acceptance of test reports at the moment. Even the calculation of all raw datas by one pivot laboratory couldn't prevent the different results.

6.1 Reasons for disagreement

6.1.1 Attribute of the patterns

The 18 kg load cell is not easy to handle. In good condition the load cell allows a very high number of load cell intervals. The temperature effect on sensitivity was not perfectly adjusted to gain a measurement effect to be compared.

The very small size and the material of the 18 kg load cell make it sensitive against gradients of the temperature. Further the single beam is asking for a very accurate force applying equipment.

The 200 kg load cell is unusually sensitive against changing of the power supply.

6.1.2 Test procedure

For some results the procedure has not been observed sufficiently.

In 4.2.2 MDLO(δ) the LAB 4 changed procedure. In 5.2.3 (MDLOR), after temperature changing the LAB 1 didn't exercise the load cell before test. In 5.2.2 MDLO(δ) and 5.2.1 Linearity ... LAB 5 didn't exercise sufficient the load cell before the test run. For calculation and averaging in the diagrams the first run has been cancelled.

The experience of PTB shows that one pre run produces more stability than three times exercising. May be that a better discribing of the exercising will do.

6.1.3 Redundancy of measured datas

For discovering of noises sometimes it is necessary to get redundancy datas, for example for creep and for MDLOR measurement.

6.1.4 Test equipment

The diagrams are gained on averaged datas, although some environmental conditions seemed to be not stable enough.

6.2 Further application of the IR 60

PTB is doing intercomparisations with every manufacturer who will get an "approval" for his load cells, hence a single test of one pattern is not sufficient to be shure that in future all built load cells of the same type will satisfy the requirements.

6.3 Future aspects

The international intercomparison should be repeated in some time. Further some long stability tests have to be added.

LOAD CELL CHARACTERISTICS, WITH ZERO CORRECTION

MANUFACTURER: ----- N=6000, LOAD CELL ERROR 70%
 TYPE : ----- NOMINAL LOAD : 18 KG
 PTB CODE : 00570 ----- MMTXX MINIMUM LOAD : 0.KG
 MDMP 39TASTATUR MAXIMUM LOAD : 18.KG

DATE	TEST NO.	RUN NO.	TEMP. CEL
27-01-86	1	1	20
28-01-86	2	1	40
29-01-86	3	1	-10
30-01-86	4	1	5
31-01-86	5	1	20

REFERENCE: 1 . TEST , 1 . RUN , 75 %

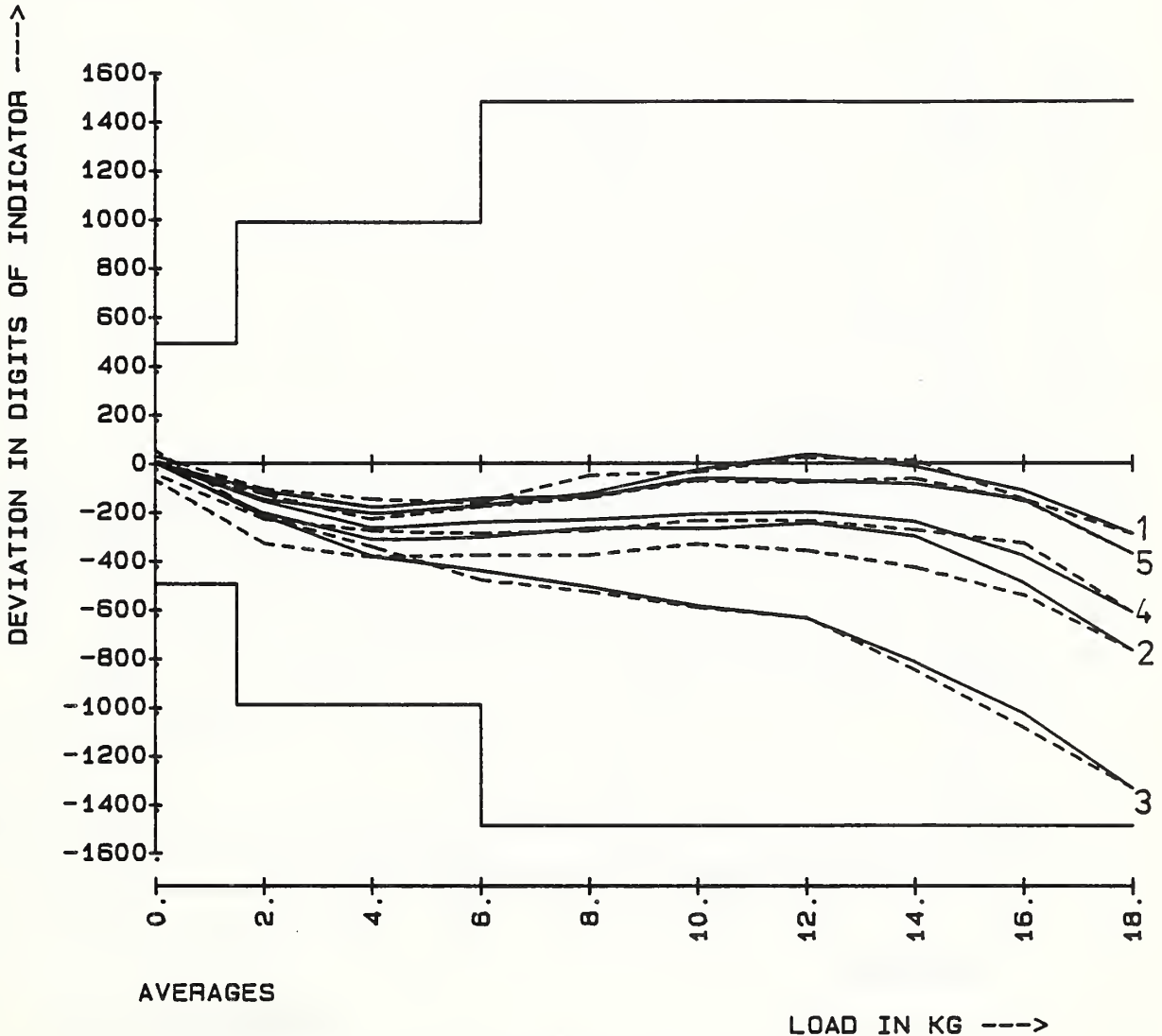

- P T B - BRAUNSCHWEIG -

LOAD CELL CHARACTERISTICS, WITH ZERO CORRECTION

MANUFACTURER:	----	N=6000, LOAD CELL ERROR 70%	
TYPE :	----	NOMINAL LOAD :	16 KG
PTB CODE : 74200	---- MMTXX	MINIMUM LOAD :	0.KG
MDMP 39TASTATUR		MAXIMUM LOAD :	16.KG

DATE	TEST NO.	RUN NO.	TEMP. CEL
02-06-86	1	1	20.2
03-06-86	2	1	42.7
04-06-86	3	1	-9.2
05-06-86	4	1	5.1
06-06-86	5	1	20.4

REFERENCE: 1 . TEST , 1 . RUN , 75 %

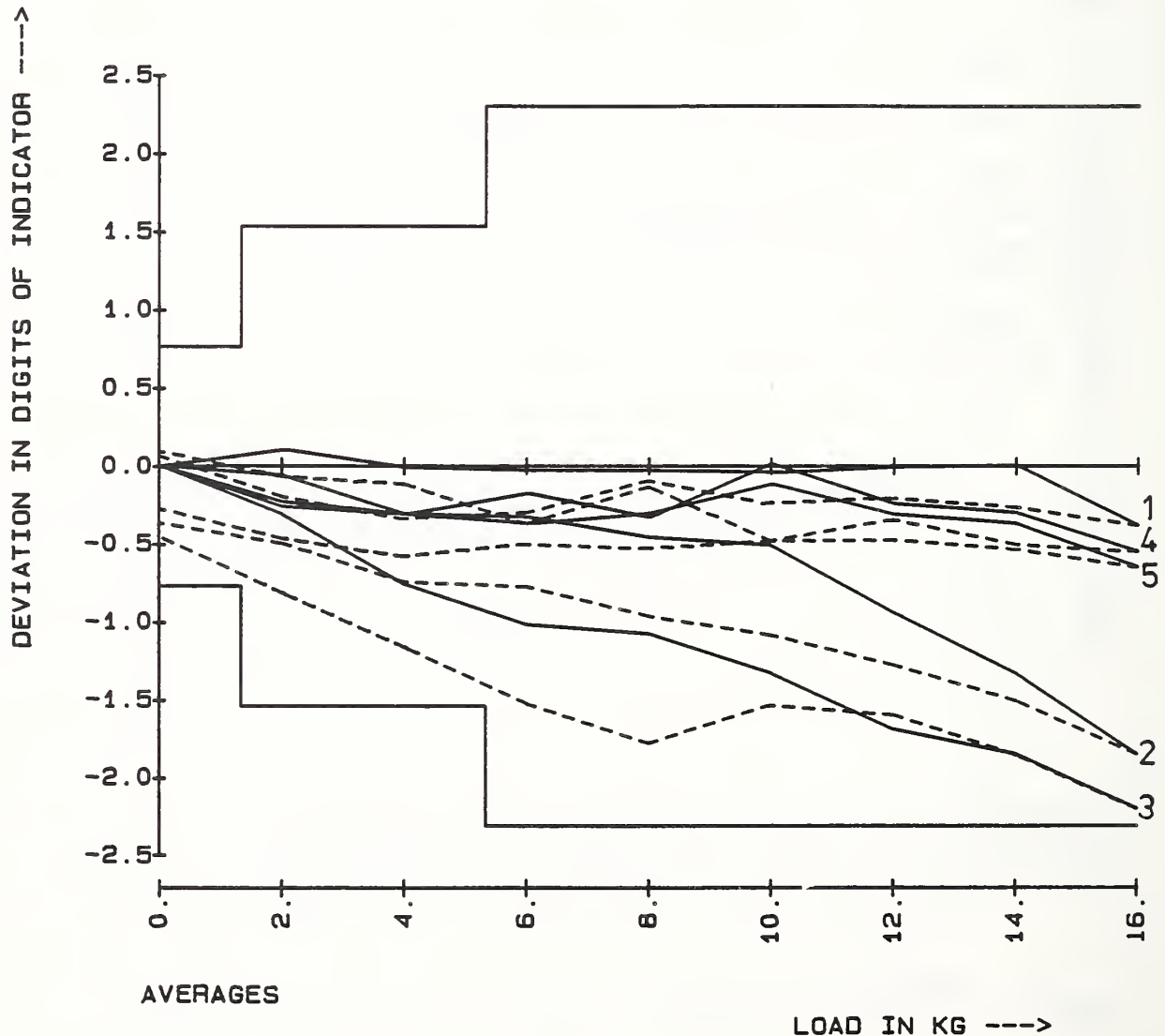

- P T B - BRAUNSCHWEIG -

LOAD CELL CHARACTERISTICS, WITH ZERO CORRECTION

MANUFACTURER:	----	N=6000, LOAD CELL ERROR 70%
TYPE :	----	NOMINAL LOAD : 18 KG
PTB CODE : 74100	---- MMTXX	MINIMUM LOAD : 0.KG
MDMP 39TASTATUR		MAXIMUM LOAD : 18.KG

DATE	TEST NO.	RUN NO.	TEMP. CEL
22-09-86	1	1	21.2
23-09-86	2	1	40.9
25-09-86	3	1	-3.1
25-09-86	4	1	5.5
26-09-86	5	1	21.4

REFERENCE: 1 . TEST , 1 . RUN , 75 %

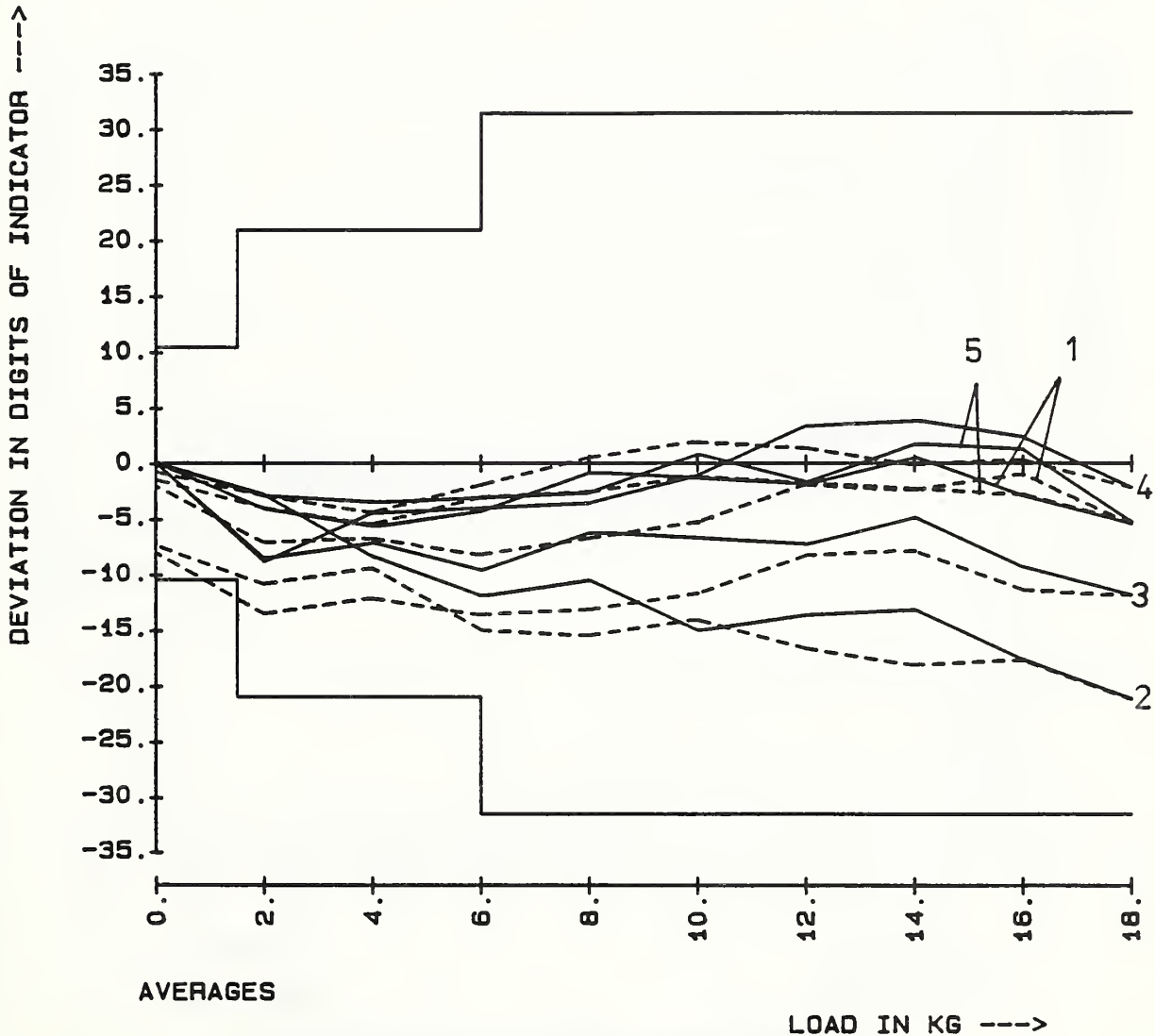

- P T B - BRAUNSCHWEIG -

LOAD CELL CHARACTERISTICS, WITH ZERO CORRECTION

MANUFACTURER: ----- N=6000, LOAD CELL ERROR 70%
 TYPE : ----- NOMINAL LOAD : 18 KG
 PTB CODE : 74400 ----- MMTXX MINIMUM LOAD : 0.00000KG
 MDMP 39TASTATUR MAXIMUM LOAD : 18.42000KG

DATE	TEST NO.	RUN NO.	TEMP. CEL
2-02-87	1	1	20.7
3-02-87	2	1	42
04-02-87	3	1	-8.5
05-02-87	4	1	5.3
6-02-87	5	1	20.7

REFERENCE: 1 . TEST , 1 . RUN , 75 %

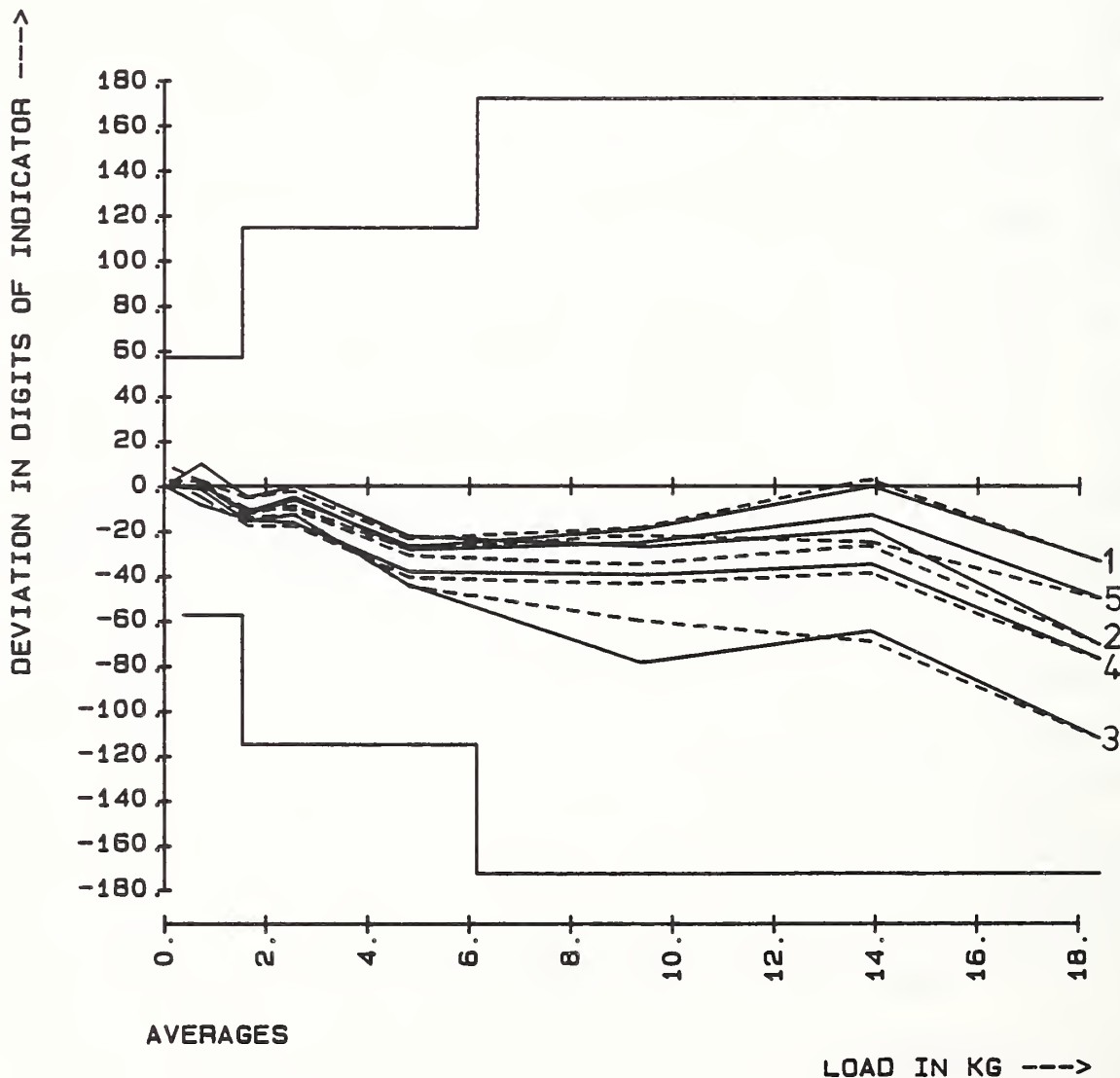

- P T B - BRAUNSCHWEIG -

LOAD CELL CHARACTERISTICS, WITH ZERO CORRECTION

MANUFACTURER: ----- N=6000, LOAD CELL ERROR 70%
 TYPE : ----- NOMINAL LOAD : 18 KG
 PTB CODE : 74300 ----- MMTXX MINIMUM LOAD : 0.KG
 MDMP 39TASTATUR MAXIMUM LOAD : 18.KG

DATE	TEST NO.	RUN NO.	TEMP. CEL
01-04-86	1	1	19.5
02-04-86	2	1	40.0
04-04-86	3	1	5.0
05-04-86	4	1	-9.0
06-04-86	5	1	20.0

REFERENCE: 1 . TEST , 1 . RUN , 75 %

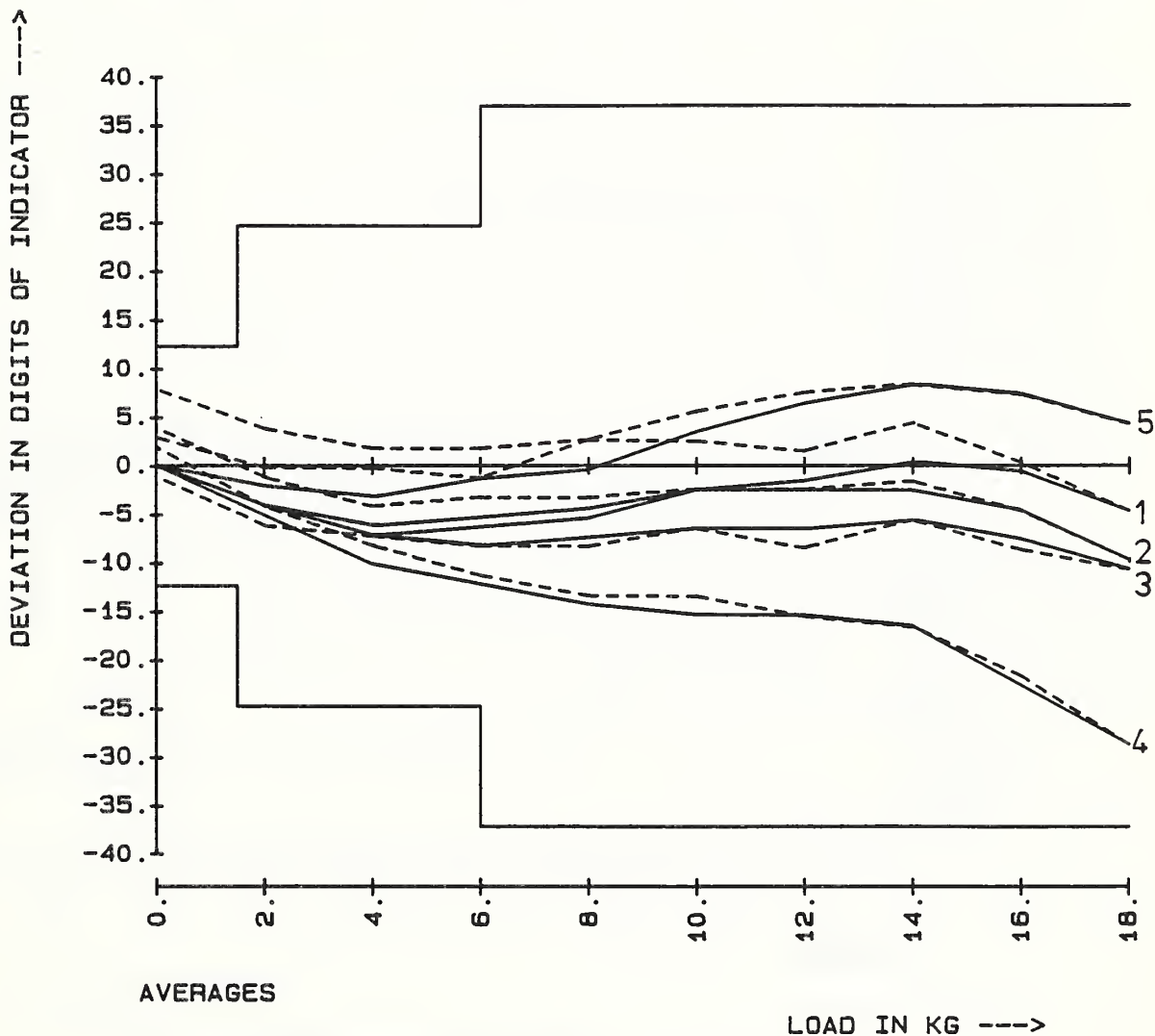

- P T B - BRAUNSCHWEIG -

LOAD CELL CHARACTERISTICS, WITH ZERO CORRECTION

MANUFACTURER:	----	N=6000, LOAD CELL ERROR 70%
TYPE :	----	NOMINAL LOAD : 18 KG
PTB CODE : 00570	---- MMTXX	MINIMUM LOAD : 0.KG
MDMP 39TASTATUR		MAXIMUM LOAD : 18.KG

DATE	TEST NO.	RUN NO.	TEMP. CEL
09-10-87	6	1	20
10-10-87	7	1	40
11-10-87	8	1	-10.5
12-10-87	9	1	5
14-10-87	10	1	20

REFERENCE: 6 . TEST , 1 . RUN , 75 %

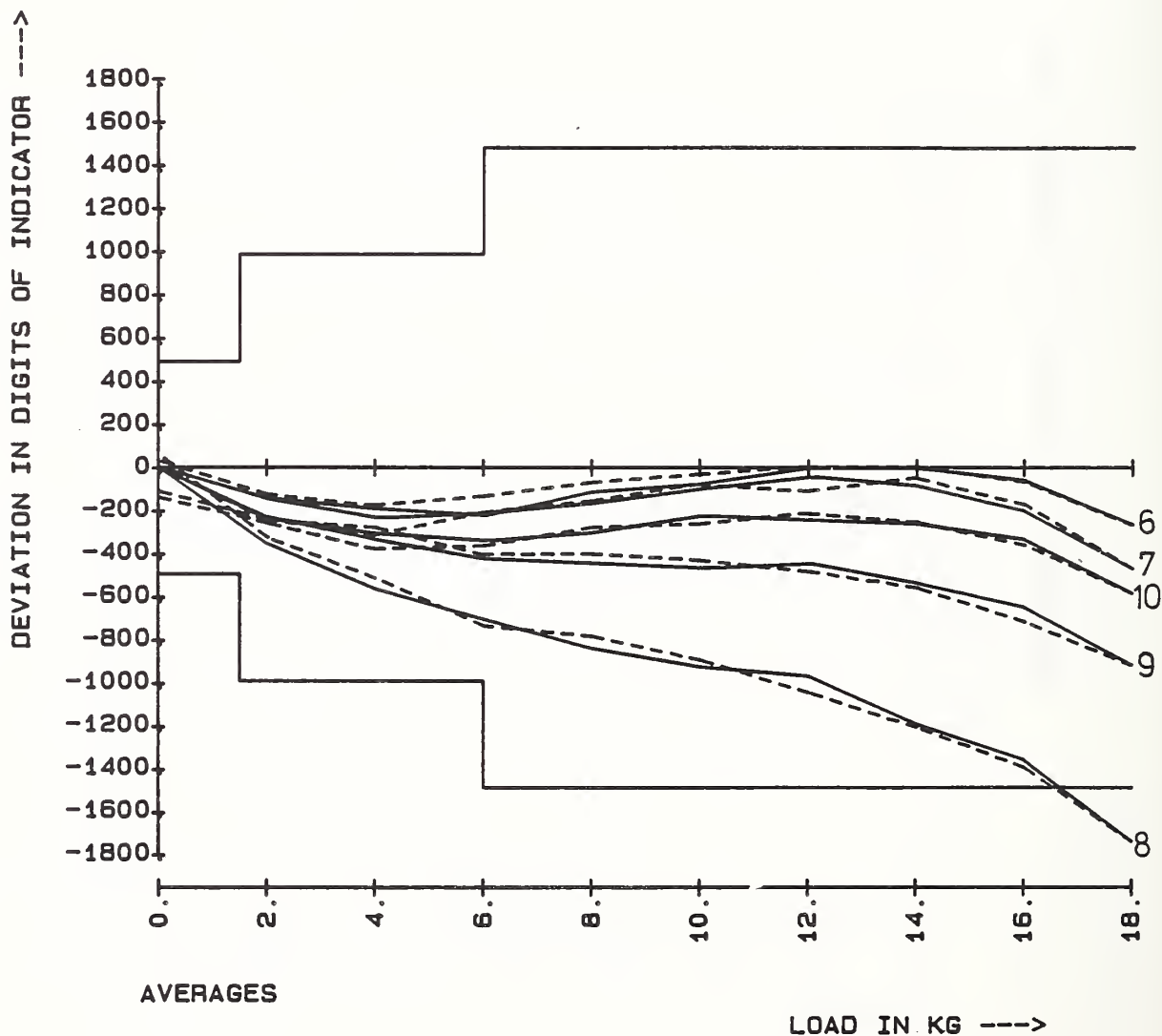

- P T B - BRAUNSCHWEIG -

LOAD CELL CHARACTERISTICS, WITH ZERO CORRECTION

MANUFACTURER: ----- N=6000, LOAD CELL ERROR 70%
 TYPE : ----- NOMINAL LOAD : 18 KG
 PTB CODE : 00570 ----- MMTXX MINIMUM LOAD : 0.KG
 MDMP 39TASTATUR MAXIMUM LOAD : 18.KG

DATE	TEST NO.	RUN NO.	TEMP. CEL
09-10-87	6	1	20
10-10-87	7	1	40
11-10-87	8	1	-10.5
12-10-87	9	1	5
14-10-87	10	1	20

REFERENCE: 1 . TEST , 1 . RUN , 75 %

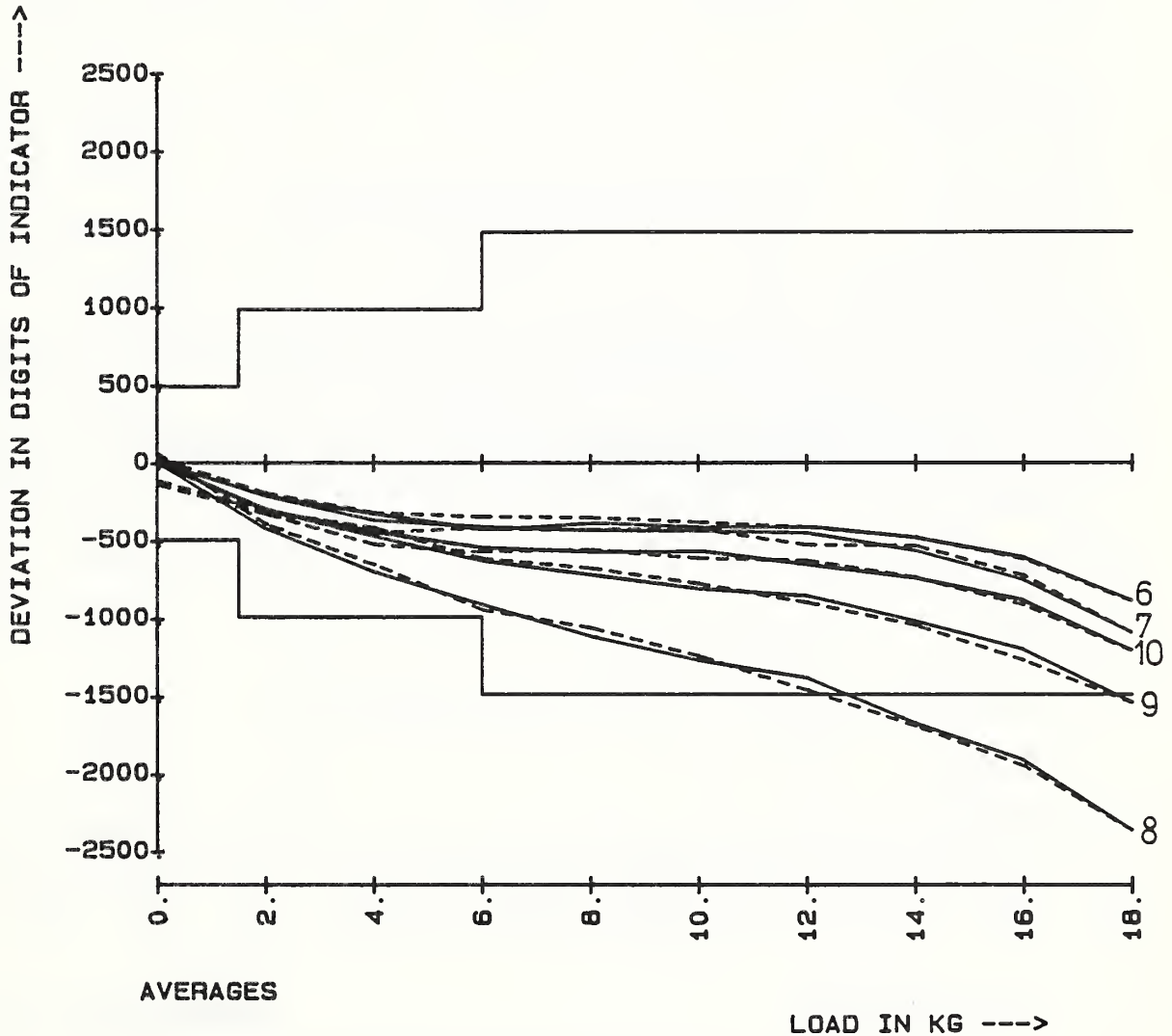

- P T B - BRAUNSCHWEIG -

LOAD CELL CHARACTERISTICS, WITH ZERO CORRECTION

MANUFACTURER : N= 3000, LOAD CELL ERROR: 70%
 F.NO/TYPE : NOM. CAPACITY : 200 KG
 CODE : 64043 MMIXX MINIMUM FORCE : 0 KN
 ZULASSUNGSPRUEF. DMP 39 IEC-BUS MAXIMUM FORCE : 2 KN

DATE	TIME	NO.	RUN	TLC/C	TR/C	R.H./%	P/MBAR
22.07.86	00:00:00	1	1	20.0	19.0	55	1010
24.07.86	00:00:00	2	1	40.0	19.0	70	1007
25.07.86	00:00:00	3	1	-10.0	19.0	55	1014
28.07.86	00:00:00	4	1	5.0	19.0	65	1023
30.07.86	00:00:00	5	1	19.9	19.5	60	1018

REFERENCE : 1 . TEST , 1 . RUN , 75 % OF MAX. LOAD

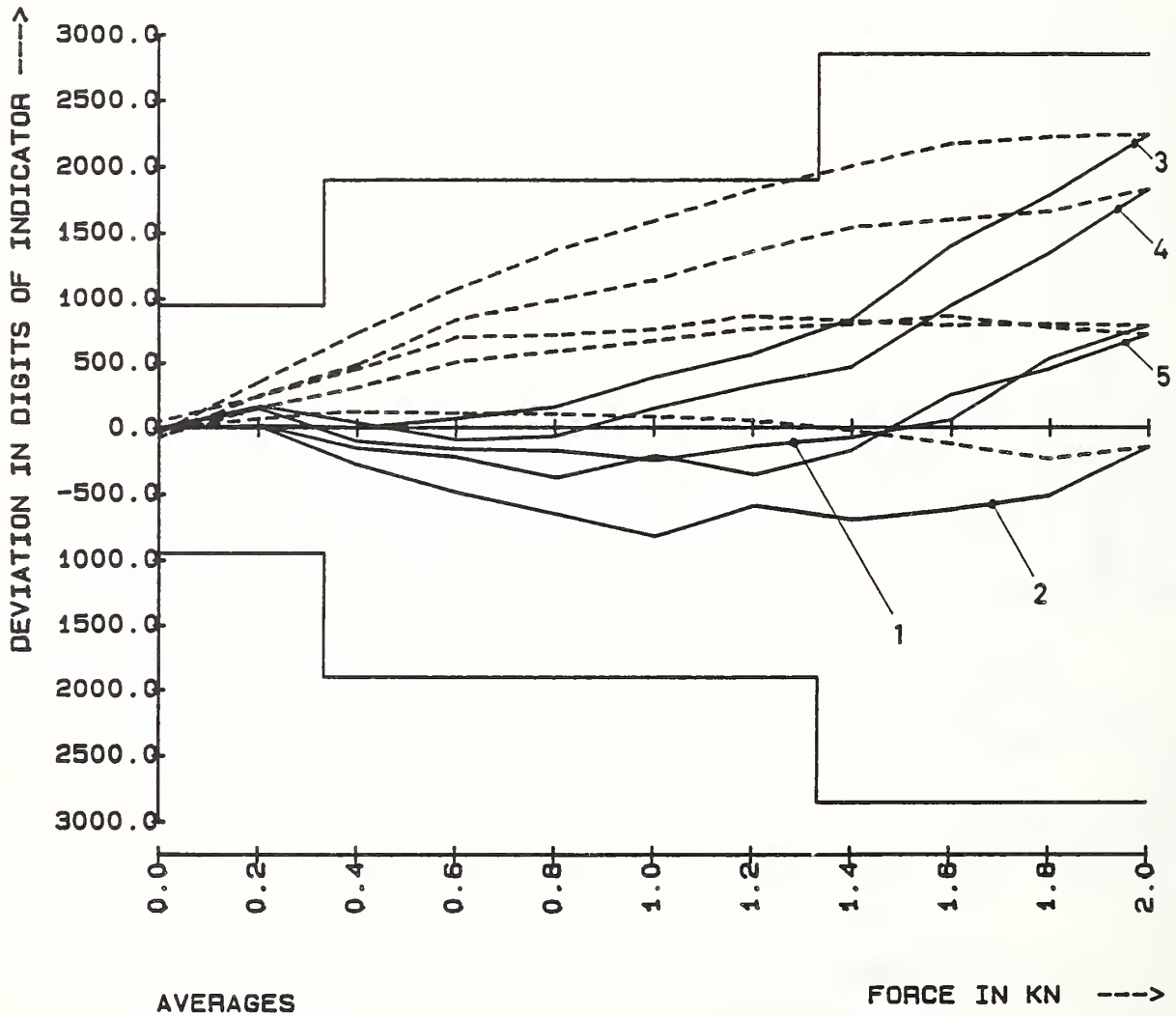

- P T B - BRAUNSCHWEIG -

LOAD CELL CHARACTERISTICS, WITH ZERO CORRECTION

MANUFACTURER:		N=3000, LOAD CELL ERROR 70%
TYPE :		NOMINAL LOAD : 400.LBS
PTB CODE : 86346	MMTXX	MINIMUM LOAD : 0.LBS
MDMP 39TASTATUR		MAXIMUM LOAD : 400.LBS

DATE	TEST NO.	RUN NO.	TEMP. CEL
09-03-87	1	1	19.8
10-03-87	2	1	39.9
11-03-87	3	1	-9.5
12-03-87	4	1	4.9
13-03-87	5	1	19.6

REFERENCE: 1 . TEST , 1 . RUN , 75 %

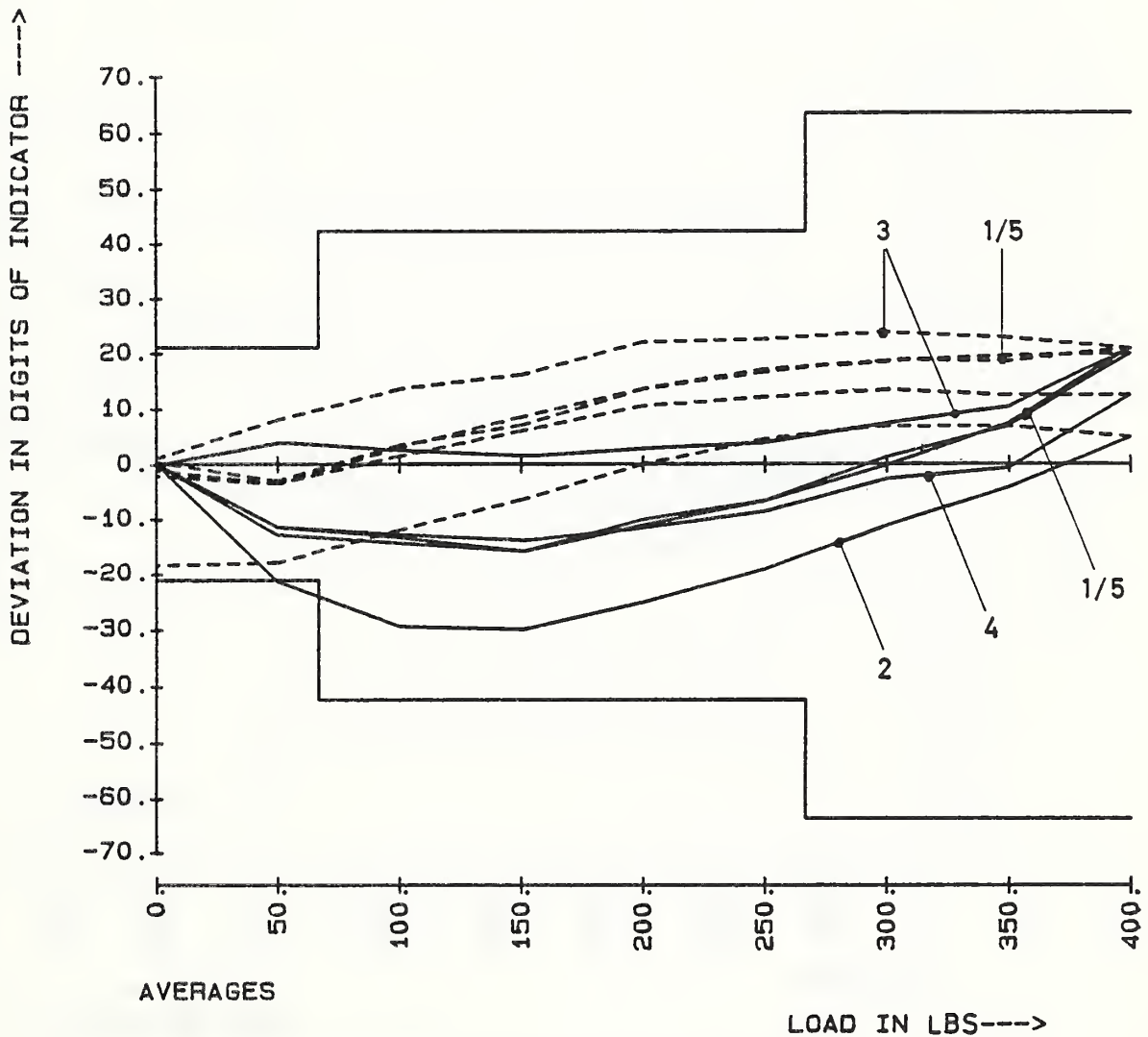

- P T B - BRAUNSCHWEIG -

LOAD CELL CHARACTERISTICS, WITH ZERO CORRECTION

MANUFACTURER:		N=3000, LOAD CELL ERROR 70%
TYPE :		NOMINAL LOAD : 500 LBS
PTB CODE : 86349	MMTXX	MINIMUM LOAD : 50.LBS
MDMP 39TASTATUR		MAXIMUM LOAD : 500.LBS

DATE	TEST NO.	RUN NO.	TEMP. CEL
15-05-87	1	1	20.6
16-05-87	2	1	38.9
16-05-87	3	1	-9.0
17-05-87	4	1	8.1
18-05-87	5	1	20.7

REFERENCE: 1 . TEST , 1 . RUN , 75 %

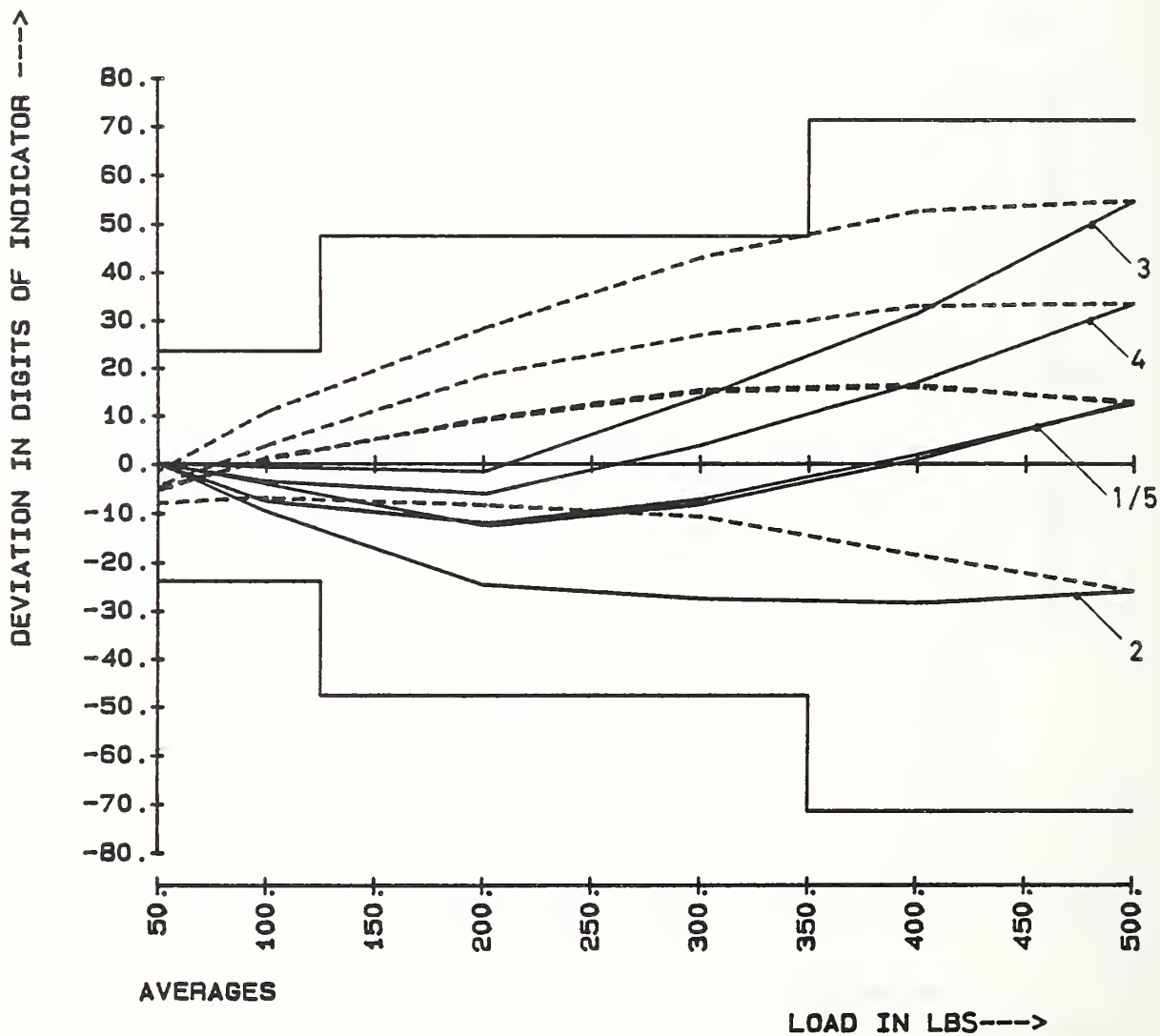

- P T B - BRAUNSCHWEIG -

LOAD CELL CHARACTERISTICS, WITH ZERO CORRECTION

MANUFACTURER:	N=3000, LOAD CELL ERROR 70%		
TYPE :	NOMINAL LOAD : 200 KG		
PTB CODE : 86345	MMTXX	MINIMUM LOAD : 0.KG	
MDMP 39TASTATUR		MAXIMUM LOAD : 200.KG	

DATE	TEST NO.	RUN NO.	TEMP. CEL
12-02-88	1	1	20
15-02-88	2	1	40
16-02-88	3	1	-5.8
17-02-88	4	1	5.5
18-02-88	5	1	20.5

REFERENCE: 1 . TEST , 1 . RUN , 75 %

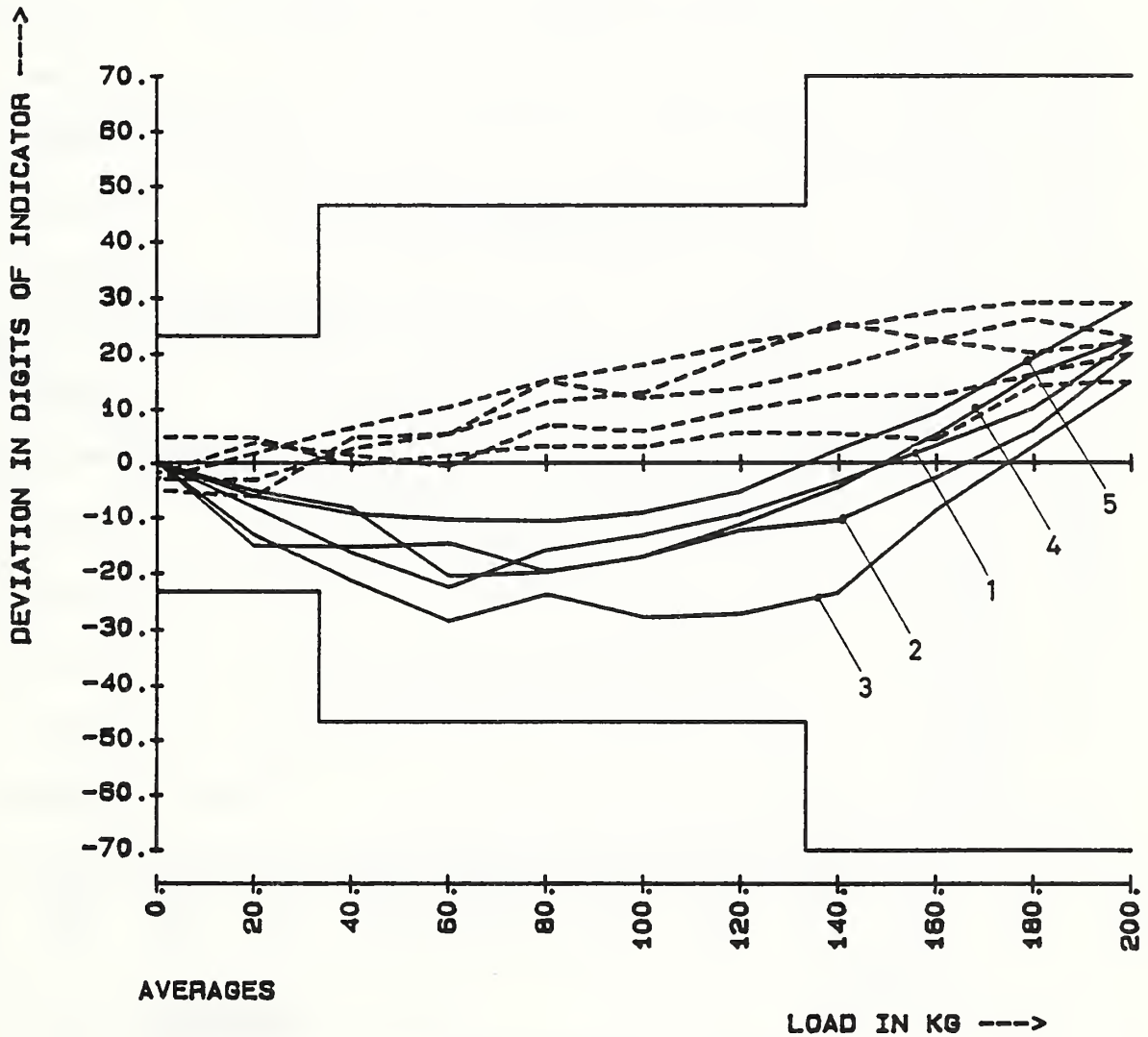

- P T B - BRAUNSCHWEIG -

LOAD CELL CHARACTERISTICS, WITH ZERO CORRECTION

MANUFACTURER:		N=3000, LOAD CELL ERROR 70%
TYPE :		NOMINAL LOAD : 200 KG
PTB CODE : 86347	MMTXX	MINIMUM LOAD : 0.KG
MDMP 39TASTATUR		MAXIMUM LOAD : 200.KG

DATE	TEST NO.	RUN NO.	TEMP. CEL
28-03-88	1	1	21.2
28-03-88	2	1	37.4
28-03-88	3	1	6.5
29-03-88	4	1	-9
30-03-88	5	1	20.5

REFERENCE: 1 . TEST , 1 . RUN , 75 %

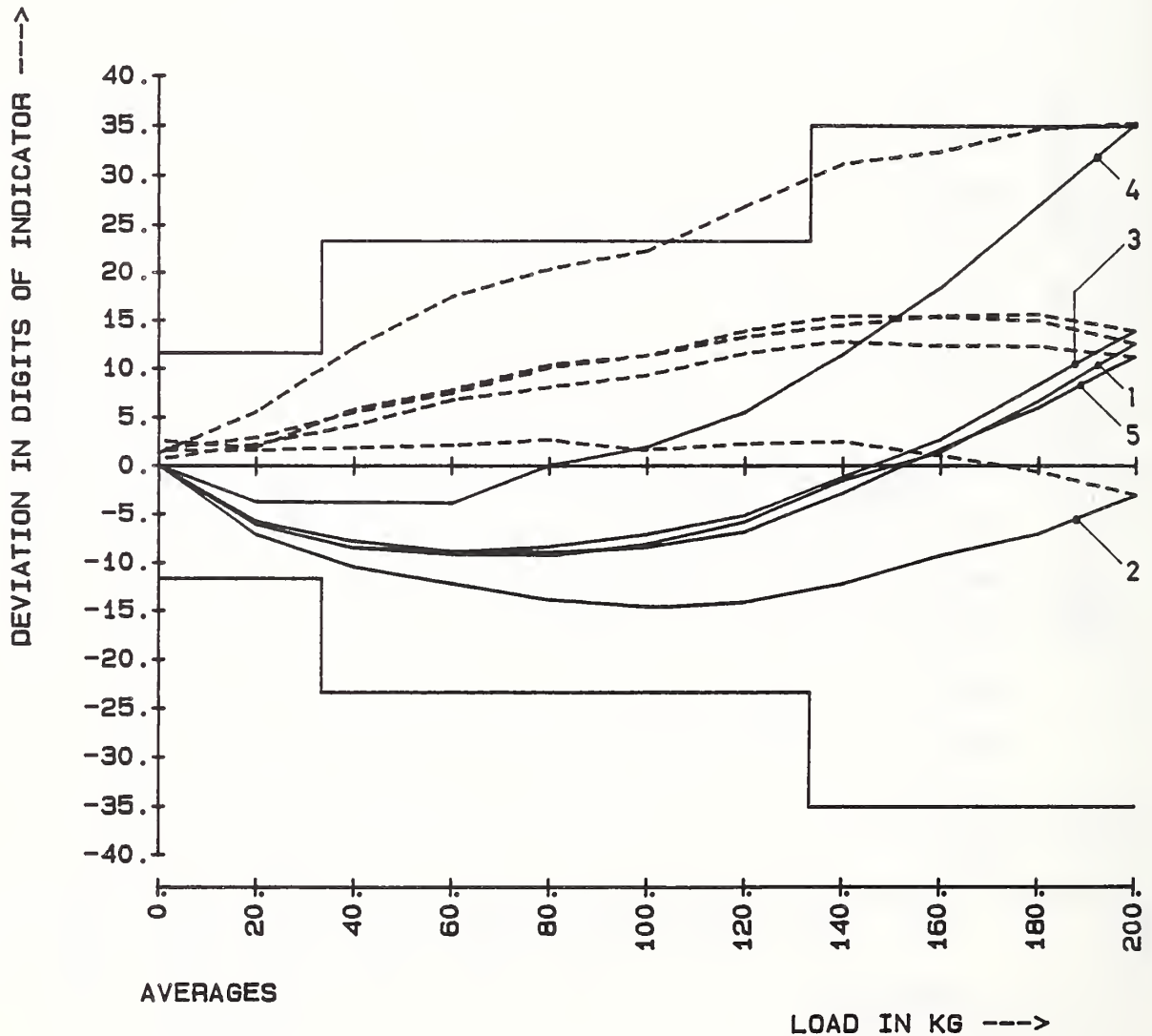

- P T B - BRAUNSCHWEIG -

LOAD CELL CHARACTERISTICS, WITH ZERO CORRECTION

MANUFACTURER : N= 3000, LOAD CELL ERROR: 70%
 F.NO/TYPE : NOM. CAPACITY : 200 KG
 CODE : 86348 MMIXX MINIMUM FORCE : 0 KN
 ZULASSUNGSPRUEF. DMP 39 IEC-BUS MAXIMUM FORCE : 2 KN

DATE	TIME	NO.	RUN	TLC/C	TR/C	R.H./%	P/MBAR
08.04.88	00:00:00	1	1	20.0	20.0	--	--
08.04.88	00:00:00	2	1	40.0	20.0	--	--
09.04.88	00:00:00	3	1	-10.0	20.0	--	--
09.04.88	00:00:00	4	1	5.0	20.0	--	--
10.04.88	00:00:00	5	1	20.0	20.0	--	--

REFERENCE : 1 . TEST , 1 . RUN , 75 % OF MAX. LOAD

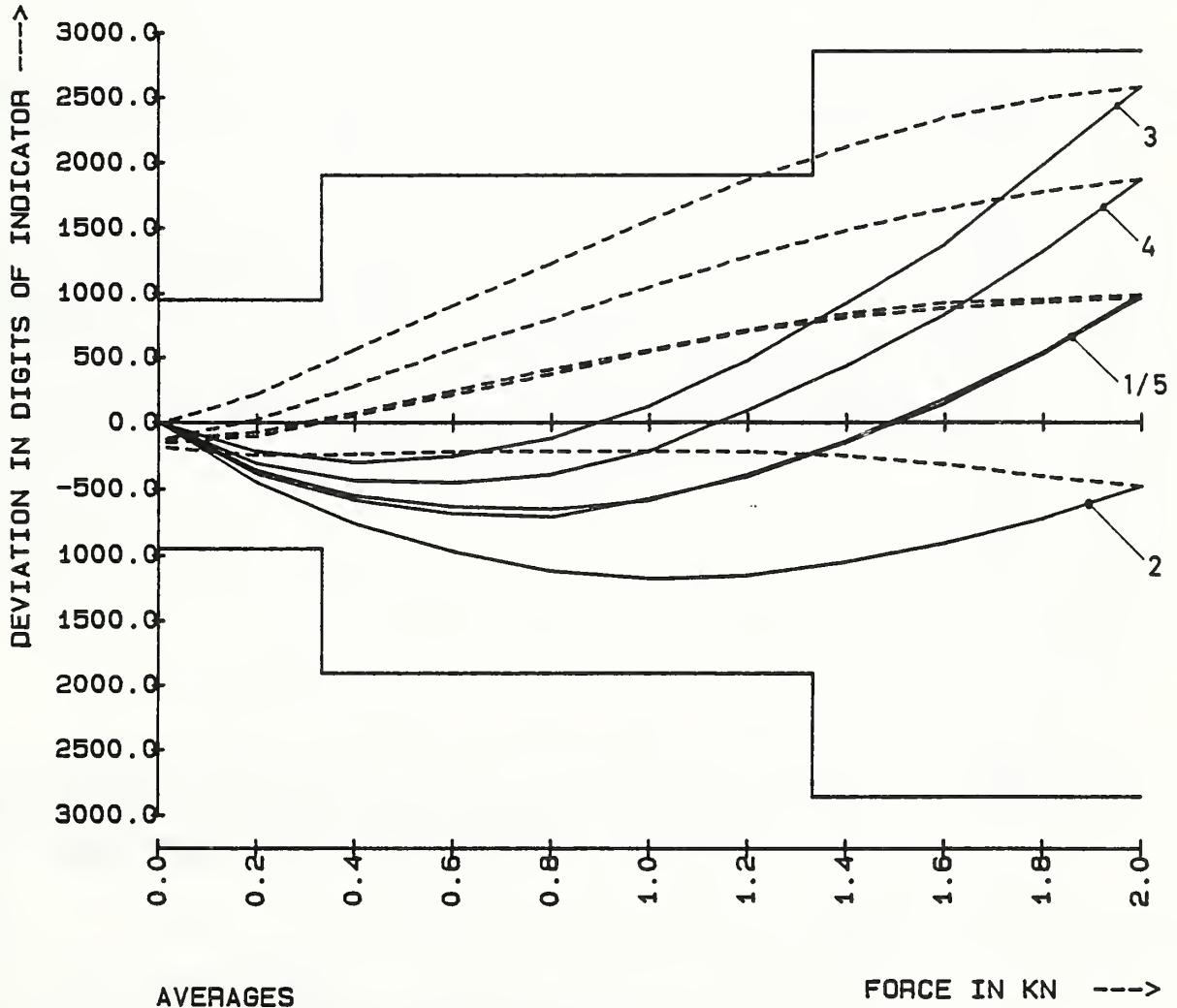

- P T B - BRAUNSCHWEIG -

LOAD CELL CHARACTERISTICS, WITH ZERO CORRECTION

MANUFACTURER:		N=3000, LOAD CELL ERROR 70%
TYPE :	863464,	NOMINAL LOAD : 2 KN
PTB CODE :	64043 MDTXX	MINIMUM LOAD : 0.0KN
MDK 37 ATASTATUR		MAXIMUM LOAD : 2.0KN

DATE	TEST NO.	RUN NO.	TEMP. CEL
2-05-86	1	1	20
05-05-86	2	1	40
06-05-88	3	1	-10
07-05-86	4	1	5
12-05-86	5	1	20

REFERENCE: 1 . TEST , 1 . RUN , 75 %

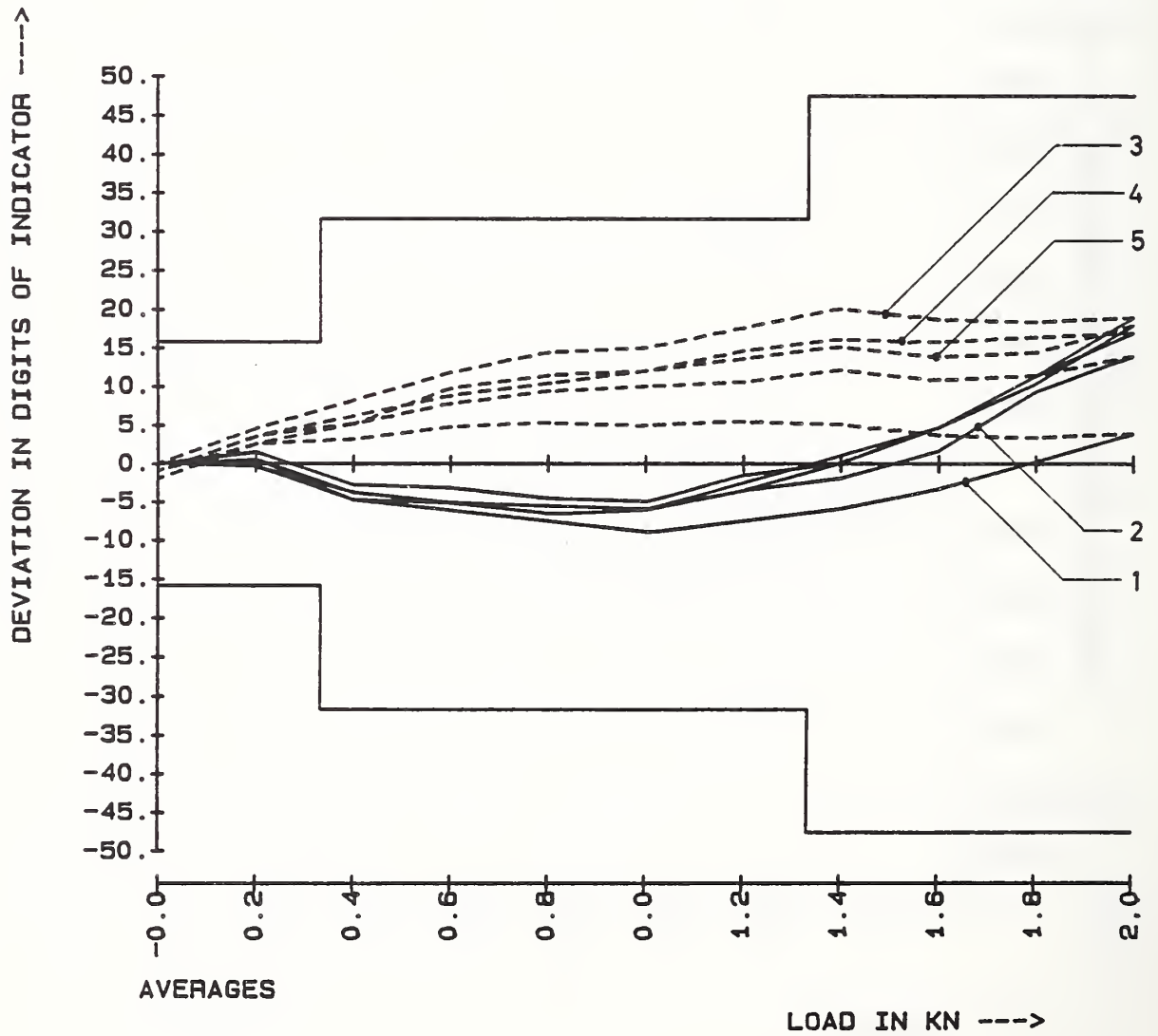

- P T B - BRAUNSCHWEIG -

BIBLIOGRAPHIC DATA SHEET

TITLE AND SUBTITLE

Intercomparison of Load Cell Verification Tests Performed by National Laboratories of Five Countries

AUTHOR(S)

Richard A. Mitchell, Simone L. Yaniv, Kenneth Yee, Otto K. Warnlof

PERFORMING ORGANIZATION (IF JOINT OR OTHER THAN NIST, SEE INSTRUCTIONS)

U.S. DEPARTMENT OF COMMERCE
NATIONAL INSTITUTE OF STANDARDS AND TECHNOLOGY
GAITHERSBURG, MD 20899

7. CONTRACT/GRANT NUMBER

8. TYPE OF REPORT AND PERIOD COVERED

Final

SPONSORING ORGANIZATION NAME AND COMPLETE ADDRESS (STREET, CITY, STATE, ZIP)

same of item 6

SUPPLEMENTARY NOTES

DOCUMENT DESCRIBES A COMPUTER PROGRAM; SF-185, FIPS SOFTWARE SUMMARY, IS ATTACHED.

ABSTRACT (A 200-WORD OR LESS FACTUAL SUMMARY OF MOST SIGNIFICANT INFORMATION. IF DOCUMENT INCLUDES A SIGNIFICANT BIBLIOGRAPHY OR LITERATURE SURVEY, MENTION IT HERE.)

A round-robin intercomparison of OIML IR 60 load cell verification tests, as performed by national laboratories of five countries, is reported. The five participating countries were Australia, the Federal Republic of Germany, the Netherlands, the United Kingdom, and the United States. Six OIML Class C load cells, ranging in capacity from 18 kg to 25000 kg, were tested by the five laboratories. The objective was to determine the comparability of the results from the verification test processes of the five laboratories, so that the laboratories could accept the results from any one laboratory and avoid the cost of retesting. Overall, the test results indicate reasonably good agreement among the five laboratories in the measurement of most of the characteristics of the six load cells. The degree and pattern of the differences in the results can serve as a guide to making refinements in the verification test processes.

2. KEY WORDS (6 TO 12 ENTRIES; ALPHABETICAL ORDER; CAPITALIZE ONLY PROPER NAMES; AND SEPARATE KEY WORDS BY SEMICOLONS)

International intercomparison; legal metrology; load cell; load cell verification test; OIML IR 60 "Load Cells"; weighing instruments

3. AVAILABILITY

UNLIMITED

FOR OFFICIAL DISTRIBUTION. DO NOT RELEASE TO NATIONAL TECHNICAL INFORMATION SERVICE (NTIS).

ORDER FROM SUPERINTENDENT OF DOCUMENTS, U.S. GOVERNMENT PRINTING OFFICE, WASHINGTON, DC 20402.

ORDER FROM NATIONAL TECHNICAL INFORMATION SERVICE (NTIS), SPRINGFIELD, VA 22161.

14. NUMBER OF PRINTED PAGES

123

15. PRICE

\$19.95

