

**NISTIR 5907**

---

---

**Proceedings of a Workshop on Developing and  
Adopting Seismic Design and Construction  
Standards for Lifelines**

---

---

Edited by  
Robert D. Dikkers, Riley M. Chung, Bijan Mohraz, H. S. Lew, and Richard N. Wright

for  
Federal Emergency Management Agency  
Mitigation Directorate  
Washington, D.C. 20472

October 1996  
Building and Fire Research Laboratory  
National Institute of Standards and Technology  
Gaithersburg, Maryland 20899



**U.S. Department of Commerce**  
Michael Kantor, *Secretary*  
**Technology Administration**  
Mary L. Good, *Under Secretary for Technology*  
**National Institute of Standards and Technology**  
Arati A. Prabhakar, *Director*

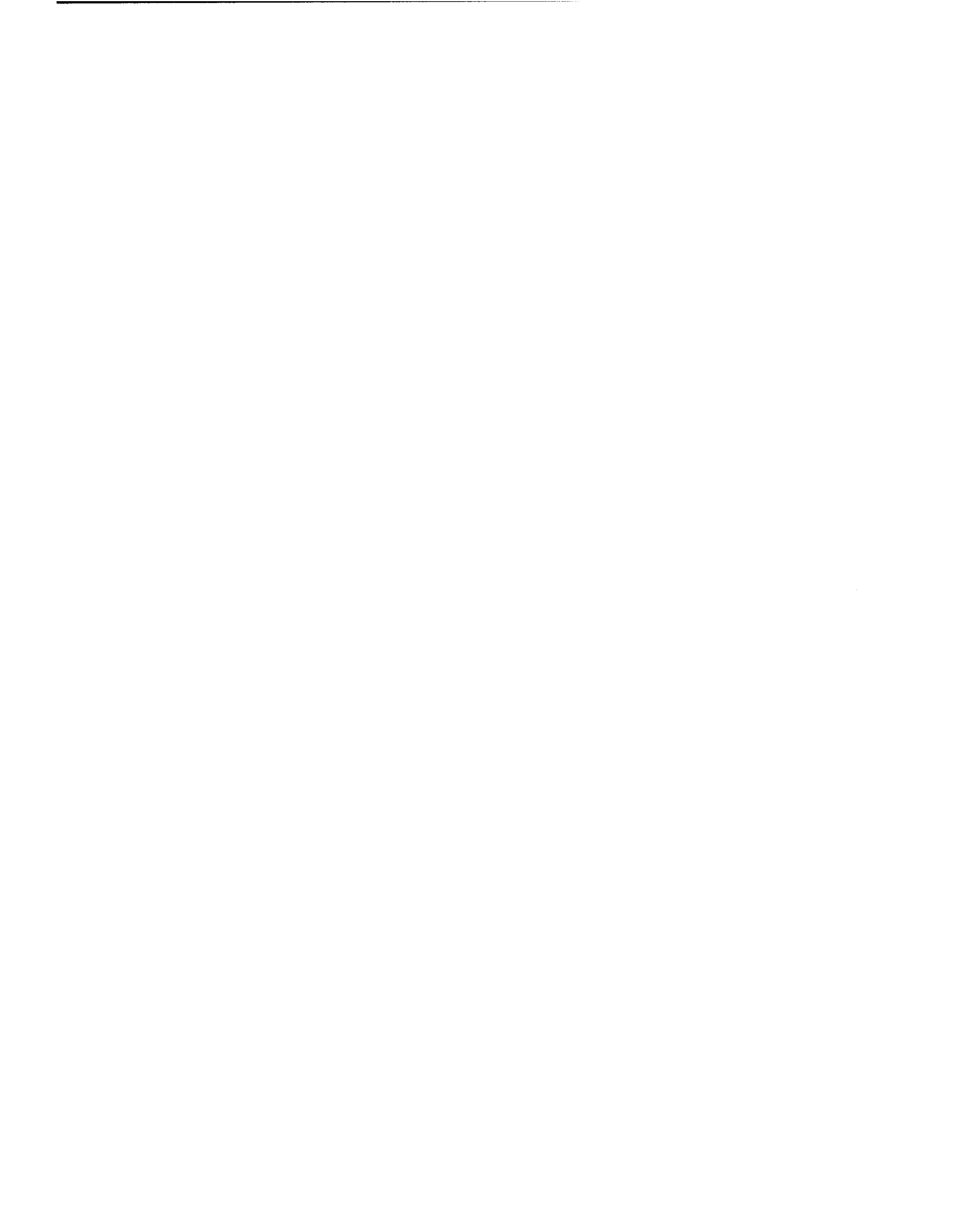


---

## NOTE

---

*Proceedings of a workshop on Developing and Adopting Seismic Design and Construction Standards for Lifelines* was prepared in 1992. The publication of the proceedings, however, was delayed until a *Plan for Developing and Adopting Seismic Design Guidelines and Standards for Lifelines* (FEMA 271, 5/96) was submitted by the Federal Emergency Management Agency to Congress in September 1995.



---

## ABSTRACT

---

The recommendations for developing and adopting seismic design and construction standards for lifelines presented in this report were prepared in response to Public Law 101-614, the National Earthquake Hazard Reduction Program (NEHRP) Reauthorization Act. The recommendations were based on inputs from experts in research and practice of lifeline earthquake engineering in private and public sectors; the Technical Council on Lifeline Earthquake Engineering of the American Society of Civil Engineers; utility organizations; and local, state, and federal government who participated in a workshop in Denver, Colorado, September 25-27, 1991. The workshop concluded that standards are needed to reduce the vulnerability of lifelines to earthquakes, and recommended the need to develop recommendations for standards, encourage and support the adoption of these recommendations by the standard organizations serving the lifeline community, and to work with the lifeline community to achieve their implementation.

Parts of these recommendations were included in the "Plan for Developing and Adopting Seismic Design Guidelines and Standards for Lifelines," *FEMA 271, 5/96*, submitted by the Federal Emergency Management Agency to Congress in September 1995.



---

# CONTENTS

---

	<b>Page</b>
Illustrations	xv
Acknowledgments	xix
Biographies of Authors	xxi
<b>EXECUTIVE SUMMARY</b>	<b>xxiii</b>
<b>CHAPTER I: INTRODUCTION</b>	
I-1.    THE CONSEQUENCES OF EARTHQUAKES	I-1
I-2.    LIFELINE VULNERABILITY TO EARTHQUAKE DAMAGE	I-1
I-3.    LIFELINES IN THE NATIONAL EARTHQUAKE HAZARDS REDUCTION PROGRAM	I-3
I-4.    BACKGROUND FOR DEVELOPMENT OF LIFELINE SEISMIC STANDARDS	I-4
I-5.    PLANNING FOR THE DEVELOPMENT OF LIFELINE SEISMIC STANDARDS	I-6
I-6.    REFERENCES	I-6
<b>CHAPTER II: ELECTRICAL POWER LIFELINES</b>	
II-1.   INTRODUCTION	II-1
II-1.1 Power System Functions, Elements, And Components	II-2
II-1.2 Power System Elements, Components, And Functions For Which Standards Should Be Applied	II-3
II-1.3 Power System Facilities For Which Seismic Standards Are Not Being Considered	II-3
II-2.   STATE OF THE ART	II-4
II-2.1 Vulnerability	II-4
II-2.1.1 Limitations In Assessing Power System Vulnerability	II-4
II-2.1.2 Basis For Evaluating Power System Vulnerability	II-5
II-2.1.3 Impact Of Seismic Hazards On Power Systems	II-5
II-2.1.4 Methods For Vulnerability Evaluation	II-7
II-2.1.5 Overall Evaluation Of Power System Vulnerability	II-8
II-2.1.6 Seismic Evaluation Of Power System Elements	II-8
II-2.1.6.1 Power-Generating Facilities	II-8
II-2.1.6.2 Transmission And Distribution Substations	II-10
II-2.1.6.3 Transmission And Distribution Lines	II-15
II-2.1.6.4 Communication (Power Utility), Monitoring, Protection, And Control Facilities And Operations	II-15

---

## CONTENTS (Continued)

---

	<b>Page</b>
II-2.1.6.5 Maintenance Support Facilities	II-16
II-2.2 Current Practice	II-17
II-2.2.1 Power-Generation Facilities	II-17
II-2.2.2 Transmission And Distribution Substations	II-17
II-2.2.3 Transmission And Distribution Lines	II-18
II-2.2.4 Communication, Monitoring, Protection, And Control Facilities and Operations	II-18
II-2.2.5 Maintenance Support Facilities	II-18
II-2.2.6 Technical Support Facilities	II-18
II-2.2.7 Emergency Planning And Response	II-18
II-2.2.8 Postearthquake Evaluation	II-19
II-2.3 Existing Knowledge	II-19
II-3. STANDARDS DEVELOPMENT	II-20
II-3.1 Introduction	II-20
II-3.2 Features And Issues Related To Electrical Power Systems	II-20
II-3.3 Overview Of The Basis And Approach To Power System Standards	II-23
II-3.3.1 Measures For Evaluating Power System Performance	II-24
II-3.3.1.1 Life-Safety	II-24
II-3.3.1.2 Financial Losses	II-24
II-3.3.1.3 Environmental Impacts	II-25
II-3.3.2 Observations On The Seismic Performance Of California Power Systems	II-25
II-3.3.3 An Approach To Seismic Standards	II-25
II-3.3.4 New Construction, Refurbishment, And Retrofitting	II-26
II-3.4 Structure Of Power System Standards	II-27
II-3.5 Standards Development Activities	II-28
II-3.5.1 Policy Statement	II-30
II-3.5.2 System Performance Evaluation Standards	II-33
II-3.5.3 Element Evaluation And Design Standards	II-34
II-3.5.4 Equipment And Material Standards	II-39
II-3.5.5 Disaster Response Planning Standard	II-44
II-3.6 Postearthquake Evaluation	II-46
II-3.7 Overall Schedule And Budget	II-48
II-4. ACKNOWLEDGMENTS	II-52
II-5. REFERENCES	II-52
II-6. APPENDICES	II-54
<b>CHAPTER III: GAS AND LIQUID FUEL LIFELINES</b>	
III-1. INTRODUCTION	III-1
III-1.1 Definitions	III-1



---

## CONTENTS (Continued)

---

	<b>Page</b>
III-1.2 Scope	III-2
III-1.3 Philosophy	III-3
III-1.3.1 Policy	III-3
III-1.3.2 System Design	III-5
III-2. STATE OF THE ART	III-5
III-2.1 Seismic Hazards For Gas And Liquid Fuel Systems	III-5
III-2.1.1 Ground Movement Effects On Pipelines	III-6
III-2.1.1.1 Fault Movements	III-6
III-2.1.1.2 Liquefaction	III-7
III-2.1.1.3 Landslides	III-8
III-2.1.2 Storage Tanks	III-8
III-2.1.3 Plant Facilities And Equipment	III-9
III-2.2 Current Practice	III-9
III-2.3 Current State Of Knowledge	III-11
III-2.3.1 Pipeline Design For Ground Movement Effects	III-11
III-2.3.1.1 Fault Movement	III-12
III-2.3.1.2 Liquefaction	III-14
III-2.3.1.3 Landslides	III-14
III-2.3.2 Storage Tanks	III-14
III-2.3.3 Gas And Liquid Fuel Plant Facilities	III-15
III-2.3.4 Seismic Contingency Plans	III-16
III-2.4 Research Needs	III-17
III-3. PLAN FOR DEVELOPMENT OF SEISMIC STANDARDS	III-18
III-3.1 System Performance Objectives	III-18
III-3.2 Vulnerability Assessment	III-19
III-3.3 Model Standards Development	III-21
III-3.3.1 Transmission Lines	III-22
III-3.3.2 Distribution Systems	III-22
III-3.3.3 Oil Storage Tanks	III-23
III-3.3.4 Refineries	III-23
III-3.4 Identification And Initiation Of Research	III-24
III-3.5 Cost And Schedule Summary	III-24
III-4. ACKNOWLEDGMENTS	III-24
III-5. REFERENCES	III-25
<b>CHAPTER IV: TELECOMMUNICATION LIFELINES</b>	
IV-1. GENERAL	IV-1
IV-1.1 Telecommunication Systems	IV-1
IV-1.2 Scope	IV-4
IV-1.3 Philosophy	IV-4
IV-1.3.1 Policy	IV-5

---

## CONTENTS (Continued)

---

	<b>Page</b>
IV-1.3.2 System Design	IV-5
IV-1.3.3 Component Design	IV-5
IV-1.3.3.1 Buildings	IV-6
IV-1.3.3.2 Underground Conduits And Manholes	IV-6
IV-1.3.3.3 Transceiver Towers And Aerial Cable Poles	IV-7
IV-1.3.4 Equipment And Material Provisions	IV-7
IV-2. SWITCHING FACILITIES	IV-8
IV-2.1 Introduction	IV-8
IV-2.2 State Of The Art	IV-9
IV-2.2.1 Vulnerability	IV-9
IV-2.2.1.1 Site Evaluation	IV-9
IV-2.2.1.2 Equipment Evaluation	IV-10
IV-2.2.1.3 Support Facilities Evaluation	IV-11
IV-2.2.1.4 Cable Distribution System Evaluation	IV-12
IV-2.2.1.5 Structural And Architectural (Nonstructural) Elements Evaluation	IV-13
IV-2.2.2 Current Practices	IV-13
IV-2.2.3 Existing Knowledge	IV-16
IV-2.3 Standards Plan For New Facilities/Construction (NF)	IV-16
IV-2.3.1 Scope	IV-16
IV-2.3.2 Standards Plan	IV-16
IV-2.4 Standards Plan For Existing Facilities (EF)	IV-18
IV-2.4.1 Scope	IV-18
IV-2.4.2 Standards Plan	IV-19
IV-3. OUTSIDE TRANSPORT FACILITIES	IV-20
IV-3.1 Introduction	IV-20
IV-3.2 State Of The Art	IV-20
IV-3.2.1 Vulnerability	IV-20
IV-3.2.2 Current Practices	IV-21
IV-3.2.3 Existing Knowledge	IV-22
IV-3.3 Standards Plan For New Facilities (NF)	IV-22
IV-3.3.1 Scope	IV-22
IV-3.3.2 Standards Plan	IV-22
IV-3.4 Standards Plan For Existing Facilities (EF)	IV-23
IV-3.4.1 Scope	IV-23
IV-3.4.2 Standards Plan	IV-23
IV-4. SYSTEM AND SPECIAL SERVICES	IV-24
IV-4.1 Introduction	IV-24
IV-4.2 State Of The Art	IV-24
IV-4.2.1 Vulnerability	IV-24
IV-4.2.2 Current Practices	IV-25
IV-4.2.3 Existing Knowledge	IV-26

---

## CONTENTS (Continued)

---

	<b>Page</b>
IV-4.3 Standards Plan For System And Special Services (SP)	IV-26
IV-4.3.1 Scope	IV-26
IV-4.3.2 Standards Plan	IV-26
IV-5. SUMMARY OF STANDARDS PLAN SCHEDULE AND PRIORITY	IV-28
IV-6. ACKNOWLEDGMENTS	IV-30
IV-7. REFERENCES	IV-30
 <b>CHAPTER V: TRANSPORTATION LIFELINES</b>	
V-1. INTRODUCTION	V-1
V-1.1 Transportation Systems	V-1
V-1.2 Scope	V-3
V-1.3 Concept	V-4
V-1.3.1 Philosophy	V-4
V-1.3.2 System Design And Construction	V-4
V-1.3.3 Component Design And Construction	V-5
V-1.3.4 Equipment And Material Provisions	V-5
V-2. PLAN FOR TRANSPORTATION STANDARDS	V-5
V-2.1 State Of The Art	V-5
V-2.1.1 Introduction	V-5
V-2.1.2 Vulnerability	V-6
V-2.1.3 Current Practice	V-8
V-2.1.4 Existing Knowledge	V-9
V-2.2 Standards Plan For Transportation Systems	V-10
V-2.3 Standards Plan For Design Of New Construction	V-11
V-2.3.1 Scope	V-11
V-2.3.2 Plan	V-12
V-2.3.3 Research Program	V-15
V-2.3.3.1 System Vulnerability	V-15
V-2.3.3.2 Geotechnical And Seismic Hazards	V-16
V-2.3.3.3 Soil-Structure Interaction	V-17
V-2.3.3.4 Structural Response	V-19
V-2.3.4 Budgets, Schedules, And Personnel	V-21
V-2.3.5 Priorities For New Construction Standards	V-23
V-2.4 Standards Plan For Retrofit of Existing Facilities	V-23
V-2.4.1 Scope	V-23
V-2.4.2 Plan	V-24
V-2.4.3 Research Program	V-26
V-2.4.3.1 Performance Criteria	V-27
V-2.4.3.2 Vulnerability Assessment Of Existing Systems	V-27

---

## CONTENTS (Continued)

---

	<b>Page</b>
V-2.4.3.3 Evaluation Of Existing Systems	V-28
V-2.4.3.4 Strengthening Of Existing Systems	V-29
V-2.4.3.5 Guidelines And Manuals For Seismic Retrofitting	V-29
V-2.4.4 Budgets, Schedules, And Personnel	V-30
V-2.4.5 Priorities For Existing Construction Standards	V-31
V-3. ACKNOWLEDGMENTS	V-32
V-4. REFERENCES	V-32
V-5. APPENDIX	V-45
 <b>CHAPTER VI: WATER AND SEWER LIFELINES</b>	
VI-1. INTRODUCTION	VI-1
VI-1.1 Elements Of A Lifeline Standard: Water And Sewer Facilities	VI-1
VI-1.2 Water And Sewer System Components	VI-1
VI-1.3 Historic Performance Of Water And Sewer Systems In Earthquakes	VI-3
VI-1.4 Current Status Of Standards	VI-4
VI-1.5 Standards Development	VI-5
VI-2. STATE OF THE ART	VI-5
VI-2.1 Introduction	VI-5
VI-2.2 Vulnerability Assessments	VI-5
VI-2.3 Current Design And Construction Practices And Standards	VI-8
VI-2.3.1 ASCE TCLEE Documents	VI-8
VI-2.3.2 Guidelines And Standards Of Practice Specifically Developed For Seismic Resistance Of Water And Sewer Facilities	VI-9
VI-2.3.3 Standards and Guidelines That Address Or Could Potentially Address Water And Sewer Facility System Components	VI-9
VI-2.4 Current System Emergency Operation Planning, Response, And Recovery Documents	VI-12
VI-2.5 Available Knowledge To Improve Existing Practice	VI-12
VI-3. STANDARDS DEVELOPMENT ACTIVITIES	VI-12
VI-3.1 Introduction	VI-12
VI-3.2 Elements Of A Lifeline Standard--Water And Sewer	VI-12
VI-3.3 Need For A System Seismic Vulnerability Assessment	VI-13
VI-3.4 Basis For Schedule And Cost Estimates	VI-14
VI-3.5 Common Areas Between Lifelines	VI-14
VI-3.6 Policy Statement	VI-15
VI-3.7 System Evaluation	VI-17

---

## CONTENTS (Continued)

---

	<b>Page</b>
VI-3.8 Component Design/Evaluation	VI-20
VI-3.9 Equipment And Material Standards	VI-22
VI-3.10 System Emergency Operation Planning, Response, And Recovery	VI-23
VI-3.11 Schedule	VI-23
VI-4. ACKNOWLEDGMENTS	VI-24
VI-5. REFERENCES	VI-24
 <b>CHAPTER VII: FEDERAL ROLES IN DEVELOPMENT, ADOPTION, AND IMPLEMENTATION OF SEISMIC DESIGN STANDARDS FOR LIFELINES</b>	
VII-1. INTRODUCTION	VII-1
VII-2. DEVELOPMENT OF DESIGN STANDARDS	VII-2
VII-2.1 Sources Of Standards	VII-2
VII-2.2 Federal Policy Toward Standards	VII-3
VII-2.3 Need For Seismic Design Standards	VII-3
VII-2.4 Recommended Plan To Develop Seismic Design Standards For Lifelines	VII-4
VII-3. ADOPTION AND IMPLEMENTATION OF LIFELINE SEISMIC DESIGN STANDARDS	VII-6
VII-3.1 Implementation--A Political And Social Context	VII-6
VII-3.1.1 Low Priority Of Seismic Risk	VII-6
VII-3.1.2 Federal Perceptions Of Seismic Risk	VII-7
VII-3.2 Implementation--An Economic Context	VII-8
VII-3.2.1 Unfunded Contingent Liability	VII-9
VII-3.2.2 Direct And Indirect Losses	VII-10
VII-3.2.3 Dependence And Interdependence	VII-10
VII-3.3 Implementation--A Regulatory Context	VII-11
VII-3.3.1 Lifelines--A Regulated Environment	VII-11
VII-3.3.2 Congressional Jurisdiction	VII-14
VII-3.3.3 Uncertain Trumpet Of Federal Seismic Regulation	VII-15
VII-3.3.4 Federal Implementation Of Lifeline Seismic Design Standards	VII-15
VII-4. ACKNOWLEDGMENTS	VII-17
VII-5. REFERENCES	VII-17
VII-A. APPENDIX	VII-26

---

**CONTENTS (Continued)**

---

	<b>Page</b>
<b>APPENDIX A: CONTRIBUTORS TO THE PLAN</b>	A-1
<b>APPENDIX B: AGENDA - LIFELINES STANDARDS WORKSHOP</b>	B-1

---

## ILLUSTRATIONS

---

	Page
<b>Figures</b>	
<i>Chapter I</i>	
1. Major crack system	I-8
2a. Four-story building	I-9
2b. Example of four-story building with multiple garages	I-9
3a. Tilting and settlement of apartment buildings	I-10
3b. Close-up view of apartment buildings affected by liquefaction	I-10
4a. Diagram of lateral spread	I-11
4b. Building pulled apart by lateral spreading	I-11
5. A 21-story steel frame building	I-12
6. Earthquakes with maximum Modified Mercalli Intensities	I-13
7. Earthquake Intensities in the Eastern and Western United States	I-14
8a. Aerial photo of collapsed portion Of Cypress Structure	I-15
8b. View Of the west Side of Cypress Structure	I-15
9a. Electrical power equipment after San Fernando earthquake of 1971	I-16
9b. Dead tank circuit breaker	I-16
9c. Older vintage live tank circuit breaker	I-16
10. Damage to oil storage tanks	I-17
11a. Oakland CO friction clip failure	I-17
11b. Conduit pinched by ironworks	I-17
12a. Aerial photo of collapsed 15.1 m deck spans	I-18
12b. Schematic detail of Pier E-9	I-18
13. Water hydrant shattered by high water pressure	I-19
14. Workshop planning	I-20
<i>Chapter II</i>	
1. Damage to turbine in the 1972 Managua, Nicaragua earthquake	II-58
2. Damaged tank	II-58
3. Imploded tanks in Sendai, Japan, from 1978 earthquake	II-59
4. Seismic stop on boiler support structure	II-59
5. Damaged steam pipe restraint	II-60
6. Transformers damaged after rolling off of rail supports in the 1971 San Fernando earthquake	II-60
7. Live-tank circuit breaker damaged in the 1988 Tejon Ranch, California, earthquake	II-61
8. Unanchored transformer slides and damages lightning arrestor	II-61
9. Damaged transformer control cables	II-62
10. Transformer bushings damaged in 1978 Sendai, Japan, earthquake	II-62
11. Current transformer damaged in the 1989 Loma Prieta earthquake	II-63
12. Disconnect switch damaged in the 1989 Loma Prieta earthquake	II-63
13. Substation control house damage	II-64
14. Control room ceiling failure in 1971 San Fernando earthquake	II-64
15. Fallen platform-mounted distribution transformer in the 1952 Kern County, California, earthquake	II-65

---

## ILLUSTRATIONS (Continued)

---

	<b>Page</b>
<i>Chapter III</i>	
1. Schematic of natural gas pipeline system	III-31
2. Schematic of liquid fuel pipeline system	III-32
3. Seismic hazards affecting transmission system	III-33
4. Types of fault movement	III-34
5. Movement of shallow buried pipeline due to strike-slip fault displacement	III-35
6. Lateral spread ground displacement	III-36
7. Landslide effect on buried pipeline	III-37
8. Water tank at Olive View Hospital	III-38
9. Example of earthquake nonstructural damage	III-39
10. Buckled steel gas pipeline	III-40
11. Pipeline trench at fault crossing	III-41
12. Schedule for gas and liquid fuel standards development	III-42
<i>Chapter IV</i>	
1. Typical outside plant	IV-32
2. Cellular radio concept	IV-33
3. Simplified long-distance network	IV-34
4. Number of COs In North America	IV-35
5. Network interconnection and names of trunks	IV-36
6. Simplified action vs reaction	IV-37
7. Open slot versus close slot shelf mounting	IV-38
8. Side post bracing applied to raised-floor application	IV-39
9. Cable bracing system using columns and walls	IV-40
10. Mechanical frame to stiffen a lineup of equipment	IV-41
<i>Chapter V</i>	
1. Collapsed bridge on the Seward Highway	V-42
2. Collapsed bridges on the Golden State Freeway	V-42
3. Collapsed control tower at Anchorage International Airport	V-43
4. Failure of fill supporting inboard crane	V-43
5. Flowchart for the development of seismic standards for transportation lifelines	V-44
<i>Chapter VI</i>	
1. Typical pipeline earthquake failure repair	VI-30
2. Damage algorithm for cast iron pipe	VI-31
3. Water main failures in the San Francisco Marina District	VI-32
4. Spring vibration isolator on engine-generator set	VI-33
5. Precariously mounted electrical power transformer	VI-34
6. Sloshing damage to a clarifier at the Rinconada water treatment plant	VI-35
7. Vulnerable chlorine container installation	VI-36
8. Liquefaction microzonation mapping for a portion of Seattle	VI-37



---

## ILLUSTRATIONS (Continued)

---

	<b>Page</b>
9. Damage algorithm for sewers subjected to permanent ground deformation	VI-38
10. Seismic upgrade to a standpipe	VI-39
11. Water and sewer program schedule	VI-40

### **Tables**

#### *Chapter II*

1. Standard development priorities and schedule	II-51
---	-------

#### *Chapter III*

1. Summary of estimated costs and schedule - seismic standards for gas and liquid fuel systems	III-30
--	--------

#### *Chapter V*

1. Partial inventory of transportation facilities in the United States	V-33
2. Public works construction, operations, and maintenance in transportation annual spending	V-33
3. Transportation systems and their components	V-34
4. Overall schedule for development of seismic standards for new and existing transportation facilities	V-35
5. Budget summary for seismic standards for new and existing transportation facilities	V-35
6. Budget summaries for standards for design of new transportation facilities	V-36
7. Schedule and budget summary standards for design of new transportation facilities	V-37
8. Priorities for the development of standards for new construction	V-38
9. Budget summaries for standards for retrofit of existing transportation facilities	V-39
10. Schedule and budget summary standards for retrofit of existing transportation facilities	V-40
11. Priorities for the development of standards for retrofitting existing construction	V-41

#### *Chapter V Appendix*

A1. Budget and personnel for highway standards for new construction	V-46
A2. Schedule and budget for highway standards for new construction	V-47
A3. Budget and personnel for railway standards for new construction	V-48
A4. Schedule and budget for railroad standards for new construction	V-49

---

## ILLUSTRATIONS (Continued)

---

	<b>Page</b>
A5. Budget and personnel for port/waterway standards for new construction	V-50
A6. Schedule and budget for port/waterway standards for new construction	V-51
A7. Budget and personnel for air transportation standards for new construction	V-52
A8. Schedule and budget for air transportation standards for new construction	V-53

### *Chapter VII*

1. U.S. standards and their developers	VII-20
2. Overlapping categories of secondary loss from lifeline network disruption	VII-21
3. Selected columns from an input-output table of the San Francisco Bay area for the year 1977	VII-22
4. Estimated direct and indirect damage dollar losses to lifelines	VII-23
5. National Earthquake Hazards Reduction Program	VII-24

### **Photos**

#### *Chapter IV*

1. Sylmar CO after San Fernando earthquake 1971	IV-42
2. A typical MDF	IV-43
3. Unanchored equipment	IV-44
4. Whittier Narrows earthquake in 1987	IV-44
5. Loma Prieta earthquake 1989	IV-45
6. Ironwork failure during Whittier Narrows earthquake in 1987	IV-45
7. Poor battery mounting	IV-46
8. Damaged batteries	IV-46
9. Structural pedestal for raised-floor application	IV-47
10. Burying fibre optic cable	IV-47
11. Above-ground fibre optic cable routing	IV-48

### **Charts**

#### *Chapter II*

1. Power system standard parts and development tasks	II-49
2. Power system standard development tasks interactions	II-50

---

## ACKNOWLEDGMENTS

---

Many private and public sector experts in the research and practice of lifeline earthquake engineering assisted in the preparation of these recommendations, in particular the Technical Council on Lifeline Earthquake Engineering (TCLEE) of the American Society of Civil Engineers (ASCE). Its 17 years of studies provide the foundation for the planned development of standards, and its members have made substantial contribution to the preparation and review of the recommendations. Special thanks are also due the staff of the National Center for Earthquake Engineering Research, whose active support and participation have been greatly appreciated.

The process for the development of the recommendations was established with the advice of a Steering Group organized by the Federal Emergency Management Agency (FEMA) and chaired by Ronald T. Eguchi, immediate past Chair of ASCE TCLEE. Authors of the recommendations include Donald Ballantyne, Ian Buckle, H. Crane Miller, Douglas J. Nyman, Anshel J. Schiff, and Alex Tang. Expert reviewers and participants at a workshop held September 25-27, 1991, in Denver, Colorado, provided valuable comments on the authors' drafts. David B. Hattis, Building Technology Inc., and Jennie E. Heard, Birch & Davis Associates, Inc., provided excellent assistance in drafting of these proceedings. A list of Steering Group members, expert reviewers, and workshop participants are given in Appendix A.

The following FEMA and National Institute of Standards and Technology (NIST) staff also participated in the planning, preparation, and review of the authors' drafts: William S. Bivins and Harold W. Andress of FEMA and Richard N. Wright, H.S. Lew, Robert D. Dijkers, and Sandy Auchmoody of NIST.



---

## BIOGRAPHIES OF AUTHORS

---

**Donald B. Ballantyne, P.E.** Mr. Ballantyne is a senior sanitary engineer with Kennedy/Jenks Consultants in Federal Way, Washington. He has a unique background as a sanitary engineer, specializing in earthquake vulnerability and loss estimation of water systems. Mr. Ballantyne has assessed seismic vulnerability and/or earthquake loss estimation for water/wastewater systems, observing the City of Seattle water system, Seattle Metro wastewater system, and systems in Everett, Washington; Portland, Oregon; San Francisco, California; and the Metropolitan Water District of Southern California. In addition, Mr. Ballantyne was a water supply specialist on earthquake reconnaissance teams for Loma Prieta (M7.0, 1989), the Philippines (M7.7, 1990), and Costa Rica (M7.4, 1991). He studied earthquake damage to treatment facilities, funded by the National Science Foundation, following the Loma Prieta earthquake. Finally, as a practicing sanitary engineer, Mr. Ballantyne has designed water treatments plants, pipelines, and pump stations. He has a broad understanding of water system operation.

**Ian G. Buckle, Ph.D.** Dr. Buckle, Professor of Civil Engineering at the State University of New York at Buffalo, is Deputy Director of the National Center for Earthquake Engineering, which is headquartered at the Buffalo campus. He is responsible for coordinating the Center's research program and the day-to-day management of the Center. A native New Zealander, Dr. Buckle is an authority on the seismic performance of bridges and is principal author of the Federal Highway Manual on Seismic Design and Retrofit of Highway Bridges. A member of several professional societies and numerous committees, he is also a member of the Transportation Subcommittee of the American Society of Civil Engineers (ASCE) Technical Council on Lifeline Earthquake Engineering.

**H. Crane Miller, Esquire.** Mr. Miller is an attorney at law in Washington, D.C. He has extensive experience in legislative, regulatory, and administrative matters, and has participated in many professional activities relating to hazard mitigation, building codes, and standards. He also authored, coauthored, or edited many publications pertinent to these topics.

**Douglas J. Nyman, Ph.D.** Dr. Nyman is a principal of Nyman Associates, Houston, Texas. He has over 18 years' experience in structural mechanics, earthquake engineering, and computer-aided design and instrumentation systems. He is past chairman of the Executive Committee of the American Society of Civil Engineers (ASCE) Technical Council on Lifeline Earthquake Engineering (TCLEE) and is a member of the ASCE TCLEE Gas and Liquid Fuels Lifelines Committee and Earthquake Engineering Research Institute (EERI). He holds M.S. and Ph.D. degrees in civil engineering (structures) from the University of Illinois. Dr. Nyman was principal investigator for the preparation of *Guidelines for the Seismic Design of Oil and Gas Pipeline Systems*, a 470-page document published by ASCE in 1984.

---

## BIOGRAPHIES OF AUTHORS (Continued)

---

**Anshel J. Schiff, Ph.D.** Founder and principal of Precision Measurement Instruments, Los Altos Hills, California, and a consulting professor in Stanford University's Department of Civil Engineering, Dr. Schiff has participated in an extensive number of earthquake engineering research and professional society activities. A primary focus of his work has been the response of lifelines during earthquakes and the impact of lifeline disruptions on emergency response operations. The author of numerous publications, he is currently Vice Chairman of the American Society of Civil Engineers (ASCE) Technical Council on Lifeline Earthquake Engineering (TCLEE) Electrical Power and Communications Lifelines Committee, Chairman of the ASCE TCLEE Executive Committee and Earthquake Investigations Committee, and the Earthquake Engineering Research Institute (EERI) Earthquake Records Committee.

**Alex Tang.** Chairman of the American Society of Civil Engineers (ASCE) Technical Council on Lifeline Earthquake Engineering (TCLEE) Electrical Power and Communications Lifelines Committee since 1989, Mr. Tang has been active in the design of telecommunication facilities since 1983. A licensed professional engineer, he has been involved in numerous lifeline earthquake engineering society activities through the Earthquake Engineering Research Institute (EERI) and the American Society of Civil Engineers (ASCE) since 1984.

---

## EXECUTIVE SUMMARY

---

### BACKGROUND AND OBJECTIVES

These recommendations for developing and adopting seismic design and construction standards for lifelines have been prepared in response to Public Law 101-614, "The National Earthquake Hazards Reduction Program (NEHRP) Reauthorization Act." Such standards will describe the properties intended for lifeline systems, equipment, and materials. They will provide both the mechanism for communication between buyers and sellers of lifeline products and services and the basis for regulations protecting the public health, safety and welfare. Properly developed and effectively implemented lifeline seismic standards will significantly reduce the vulnerability of both new and existing lifeline systems to future earthquakes.

The recommendations are based on inputs from private and public sector experts in research and practice of lifeline earthquake engineering. The participants in both the planning and the workshop held from September 25 to 27, 1991, in Denver, Colorado, represented the principal private and public sector organizations concerned with lifeline systems, such as the Technical Council on Lifeline Earthquake Engineering (TCLEE) of the American Society of Civil Engineers (ASCE); associations of utilities; and local, State and Federal governmental agencies. These experts concluded that standards are needed to reduce the vulnerability of lifelines to earthquakes, and that adequate knowledge bases exist or can be developed within this decade to produce the standards. Their guidance focuses on developing recommendations for standards, encouraging and supporting the adoption of these recommendations by the standards organizations serving the lifelines community, and working with the lifelines community to achieve their effective implementation.

### THE NEED FOR LIFELINE SEISMIC STANDARDS

Lifelines are the public works and utilities systems that support most human activities: individual, family, economic, political, and cultural. Lifeline systems comprise electrical power, gas and liquid fuels, telecommunications, transportation, and water supply and sewers. Failures of lifelines can be directly hazardous to life: spills of flammable and/or toxic liquids, conflagrations, explosions and/or collapses of structures may result. Even more significant are indirect consequences of failures, such as impossible living conditions in homes without power or fuel, loss of transportation, and loss of employment and production without lifelines services. Indeed, the loss of lifeline services over wide areas for extended periods of time, such as loss of oil and natural gas supplies through major pipeline distribution systems for the northeastern United States as a result of a devastating earthquake in the central United States, would severely damage the economy, security, and international competitiveness of the Nation.

At least 39 of the 50 states are subject to severe or moderate hazards of earthquakes. While earthquake occurrence is most frequent in California and Alaska, an earthquake can cause damage over a much larger area east of the Rocky Mountains, since in that region, ground motions attenuate much less with distance. An earthquake occurring east of the Rocky Mountains would affect an area ten times or more larger than an area of equal magnitude occurring in the West.

---

## EXECUTIVE SUMMARY (Continued)

---

Experiences in recent earthquakes show that lifeline systems not designed and constructed for earthquake resistance are subject to failure when exposed to earthquake effects. In the San Francisco Bay area some 60 miles from the epicenter of the 1989 Loma Prieta, California, earthquake, collapse of an elevated highway killed 42 persons and failure of San Francisco's water system hampered fire fighting. Fortunately, conflagration was avoided by unusually calm winds. Failure of the Oakland Bay Bridge disrupted economic activities for weeks, and still today surface transportation is inhibited by failures of elevated highway structures. These lifeline failures, it must be noted, occurred relatively far from an earthquake in our best-prepared State.

While loss of life and property damage would be confined within an earthquake's felt area, economic losses, particularly those caused by the failure of lifeline systems, can be widely spread throughout the Nation as the result of the Nation's close interdependency of its commerce activities. Recent studies indicate that lifeline damages and losses of service can exceed \$10 billion for a Cape Anne, Massachusetts; New Madrid, Missouri; Charleston, South Carolina; San Francisco Bay area or Southern California earthquake. The insurance industry's Earthquake Project has estimated that losses from a single severe earthquake affecting a major metropolitan area could cause insured losses exceeding \$50 billion that would threaten the viability of the insurance industry.

Each type of lifeline has shown vulnerability to earthquakes. Further, lifeline systems are interdependent and interactive. The failure of one lifeline--electrical power, for example--would impact all of the other lifelines.

While earthquakes are inevitable hazards, they are not inevitable disasters. Experiences in recent earthquakes have shown that lifelines properly designed to resist earthquakes perform well in spite of severe earthquake effects. For instance, the Bay Area Rapid Transit System, which received special attention to seismic safety during its design, was functional immediately after the Loma Prieta earthquake.

Currently, nationally recognized standards for the design and construction of lifeline systems for seismic safety exist only for highway bridges, nuclear power reactors, and dams. These are areas where Federal initiative has been undertaken to support the standards' development. Federal initiative is needed because benefits extend broadly to private and public sector organizations. No single company, trade association, profession or State can alone assume the costs of developing nationally applicable standards consistent among all the interdependent types of lifelines. In addition, while voluntary private sector participation is essential to success of the program, private organizations can justify participation only if that participation is likely to produce timely results important to their respective businesses. Therefore, it is incumbent upon the Federal Government to act in support of the development of nationally applicable seismic standards for lifelines.



---

## EXECUTIVE SUMMARY (Continued)

---

At present, because of the lack of standards, most utilities, public works organizations, and regulatory agencies lack authoritative technical bases for their seismic safety requirements. Lifeline standards should include provisions for system performance, including functionality during and immediately after an earthquake, performance of elements (subsystems) required to obtain desired system performance, and properties required of equipment and materials. These provisions must be consistent with the seismic hazards of a locality (i.e., more resistant lifelines in areas of greater seismic hazard) if they are to provide consistent reliabilities.

### STRATEGY FOR DEVELOPMENT AND IMPLEMENTATION

There are diverse private and public sector responsibilities for the performance of lifeline systems, and seismic safety is but one of many requirements for successful performance of lifelines. The findings of the Denver workshop, therefore, call for work with and in support of existing organizations of the lifelines community to develop recommendations for seismic safety standards that are suitable for incorporation in existing lifeline standards. These standards, subsequently, can be used voluntarily by lifelines organizations or referenced in regulations of local, State or Federal agencies.

It is recommended that the National Institute of Standards and Technology create an "umbrella" lifelines seismic standards group to monitor and coordinate the standards development process.

### STANDARDS DEVELOPMENT ACTIVITIES

While standards development activities focus on development of recommendations for standards, the scope of the proposed work includes applied research to obtain critically needed knowledge and participation in the incorporation of the recommendations into lifelines standards. Two areas, however, are not included: standards for dams are treated by the Interagency Committee on Dam Safety, and standards for nuclear power facilities are provided by the Nuclear Regulatory Commission.

For the majority of the lifelines considered, the recommended workplan for each lifeline follows a common outline:

- o **Policy Statement/Philosophy**--Defines the earthquake hazards to be considered and the desired system performance. Particular attention is given to the need for the lifeline service to be available during and immediately after the earthquake. Contingency response, repair, and restoration objectives are included.
- o **System Performance Standard**--Defines procedures for evaluating the seismic performance of the lifeline system to determine if the policy statement is satisfied.

---

## EXECUTIVE SUMMARY (Continued)

---

- o **Element Standards**--Includes standards for the design of new elements (subsystems) and for the evaluation of existing elements. Element standards provide data for evaluating the seismic performance of the lifeline system using the system performance standard.
- o **Equipment and Materials Standards**--Establishes seismic design criteria for new equipment and materials and condition assessment standards for existing equipment and materials.

A specific lifeline typically has a long life and is continually maintained and improved. Lifeline standards, therefore, are recommended for both incremental upgrading of existing lifelines and new construction.

Trial evaluation and design studies are suggested to explore the efficacy and economic consequences of proposed recommendations for standards. These studies will contribute to the improvement of the recommendations and provide understanding of the proposed system performance requirements. Construction cost estimates will indicate the economic implications of adopting each standard.

Detailed recommendations for standards (prestandards) should be developed simultaneously for all lifeline types. Since lifelines are interdependent, there is little justification for adoption of seismic safety standards for one lifeline if its earthquake performance would be crippled by failure of other lifelines.

Recommended priorities and funding levels for standards development and research activities are provided for each of the lifelines. In summary, the funding levels are as follows: electrical power, \$5,040,000; gas and liquid fuel, \$5,850,000; telecommunications, \$6,800,000; transportation, \$31,310,000; water and sewer, \$5,700,000. The total funding level for all lifelines is \$54,700,000.

## MANAGEMENT AND COORDINATION

Consistent with National Institute of Standards and Technology's role as NEHRP principal agency for research and development to improve building codes and standards and practices for structures and lifelines, it is recommended that NIST have the lead responsibility in the development of lifeline seismic standards. In regard to Federal agency participation and coordination in the standards development activities, it is recommended that the Interagency Committee on Seismic Safety in Construction (ICSSC) be the primary focal point.

As mentioned previously, it is recommended that the National Institute of Standards and Technology create an "umbrella" lifelines seismic standards group to monitor and coordinate the

---

## EXECUTIVE SUMMARY (Continued)

---

standards development process.

### IMPLEMENTATION

The recommendations for standards should be implemented primarily through existing voluntary consensus standards for lifeline systems, elements, equipment, and materials. When available, lifeline seismic standards should be referenced or adopted in the specifications of owners and the regulations of State and local governments. Federal use of the recommendations for standards would follow the President's Office of Management and Budget Circular A-119, *Federal Participation in the Development and Use of Voluntary Standards*, that states that voluntary standards should be adopted and used by Federal agencies unless they are specifically prohibited by law from doing so.

To expedite Federal implementation of lifeline seismic standards, it is recommended that an executive order be drafted to provide requirements for Federal agencies to adopt and use seismic standards for Federal and Federally assisted or regulated new and existing lifelines.



---

## **CHAPTER I: INTRODUCTION**

---

### **I-1. THE CONSEQUENCES OF EARTHQUAKES**

Among natural hazards, earthquakes can be the most devastating. The sudden release, without warning, of strains accumulated in a fault system, causes a tremendous amount of energy to be dissipated in all directions through the propagation of seismic waves. As a result, several phenomena can be observed: A major earthquake may cause changes in elevation and surface ruptures (see Figure 1) over a large geographic area. Strong ground shaking may precipitate landslides and the liquefaction of loosely compacted and saturated sandy deposits. This temporary loss of soil bearing strength would cause tilting, excessive settlement, or lateral spread of structures' foundations (see Figures 2, 3, and 4).

In addition to the effect that seismic waves have upon the ground, they also have an effect on structures as well. Structures resting on the ground are excited into vibration as a function of their frequency response to seismic waves. Low buildings and short and stiff bridges, which have higher response frequencies, will respond to the incoming seismic waves first, followed by tall buildings and long lifeline systems that have lower response frequencies. When the ground and the structure vibrate at or close to the same frequency, this resonance can cause local amplification of ground shaking and lead to severe damage or total collapse of inadequately designed and constructed structures (see Figure 5).

### **I-2. LIFELINE VULNERABILITY TO EARTHQUAKE DAMAGE**

Lifelines are the public works and utilities systems that support most human activities: individual, family, economic, political, and cultural. Lifeline systems comprise electrical power, gas and liquid fuels, telecommunications, transportation, and water supply and sewers. Failures of lifelines as the outcome of an earthquake can be directly hazardous to life: spills of flammable and/or toxic liquids, conflagrations, explosions and/or collapses of structures may result. Even more significant are indirect consequences of failures, such as impossible living conditions in homes without power or fuel, loss of transportation, and loss of employment and production without lifelines services. Indeed, the loss of lifeline services over wide areas for extended periods of time would severely damage the economy, the security and the international competitiveness of the Nation. For example, a devastating earthquake in the central United States could damage major transmission pipelines, resulting in energy shortages in the northeastern States and the Midwest.

At least 39 of the 50 States are subject to severe or moderate hazards of earthquakes. Major historical earthquakes include Cape Anne, Massachusetts, 1755; New Madrid, Missouri, 1811 and 1812; Charleston, South Carolina, 1886; San Francisco, California, 1906; Prince William Sound, Alaska, 1964; Seattle, Washington, 1965; San Fernando, California, 1971; and Loma Prieta, California, 1989 (see Figure 6). While earthquake occurrence is most frequent in California and Alaska, an earthquake can cause damage over a much larger area east of the Rocky Mountains, since in that region, ground motions attenuate much less with distance. An earthquake occurring east of the Rocky Mountains would affect an area ten times or more larger than an earthquake of equal magnitude occurring in the West (see Figure 7).

Experiences in recent earthquakes show that lifeline systems not designed and constructed for earthquake resistance are subject to failure when exposed to earthquake effects. In the San

## RECOMMENDATIONS FOR LIFELINE SEISMIC STANDARDS

Francisco Bay area some 60 miles from the epicenter of the 1989 Loma Prieta, California, earthquake, collapse of an elevated highway killed 42 persons (see Figure 8), and failure of San Francisco's water system hampered fire fighting. Fortunately, conflagration was avoided by unusually calm winds and the implementation of a portable water supply system designed to fight fires during earthquakes. Failure of the Oakland Bay Bridge in that same area disrupted economic activities for weeks, and even today, surface transportation there is inhibited by failures of elevated highway structures. What is even more important to note, however, is that these lifeline failures occurred relatively far from the earthquake epicenter in our best-prepared State.

Assessments of earthquake hazards indicate that one or more severe earthquakes can be expected to strike U.S. metropolitan areas in the next decade [1]. Until actions are taken to improve the design and construction of lifelines, lifeline failures can be expected to contribute substantially to losses estimated at tens of thousands of lives and tens of billions of dollars for a single severe earthquake [2,3,4].

While loss of life and property damage would be confined within an earthquake's felt area, economic losses, particularly those caused by the failure of lifeline systems, can be widely spread throughout the Nation as the result of the Nation's close interdependency of its commerce activities. Recent studies indicate that lifeline damages, loss of services, and related indirect economic losses can exceed \$10 billion for a Cape Anne, Massachusetts; New Madrid, Missouri; Charleston, South Carolina; San Francisco Bay area or Southern California earthquake [5]. The insurance industry's Earthquake Project has estimated that losses from a single severe earthquake affecting a major metropolitan area could cause insured losses exceeding \$50 billion that would threaten the viability of the insurance industry [6].

Each type of lifeline has shown vulnerability to earthquakes. For instance, electrical power substations suffer severe damage (see Figure 9); oil or gas tanks lose their contents (see Figure 10); telecommunications switching equipment collapses (see Figure 11); bridges collapse (see Figure 12); and water pipes rupture (see Figure 13). Further, lifeline systems are interdependent and interactive. The failure of one lifeline—electrical power, for example—would impact all of the other lifelines.

While earthquakes are inevitable hazards, they are not inevitable disasters. Experiences in recent earthquakes have shown that lifelines properly designed to resist earthquakes perform well in spite of severe earthquake effects. For instance, the Bay Area Rapid Transit System, which received special attention to seismic safety during its design, was functional immediately after the Loma Prieta earthquake.

Currently, nationally recognized standards for the design and construction of lifeline systems for seismic safety exist only for highway bridges, nuclear power reactors, and dams. These are areas where Federal initiative has been undertaken to support the standards' development. Federal initiative is needed not only because benefits extend broadly to private and public sector organizations, but also because no single company, trade association, profession, or State can alone assume the costs of developing nationally applicable standards consistent among all the interdependent types of lifelines. In addition, while voluntary private sector participation is essential to success of the program, private organizations can justify their participation only if that participation is likely to produce timely results important to their respective businesses. Therefore, it is incumbent upon the Federal Government to act in support of the development of nationally applicable seismic standards for lifelines.

At present, because of the lack of standards, most utilities, public works organizations, and

regulatory agencies lack authoritative technical bases for their seismic safety requirements. Lifeline standards should include provisions for system performance, including functionality during and immediately after an earthquake, performance of elements (subsystems) required to obtain desired system performance, and properties required of equipment and materials. These provisions must be consistent with the seismic hazards of a locality (i.e., more resistant lifelines in areas of greater seismic hazard) if they are to provide consistent reliabilities.

A plan for developing and adopting seismic design and construction standards for lifelines is being prepared in response to Public Law 101-614, The National Earthquake Hazards Reduction Program Reauthorization Act. The standards will describe the properties intended for lifeline systems, products, and services; provide the mechanism for communication between buyers and sellers of lifeline products and services; and also provide the basis for regulations protecting public health, safety and welfare. As in the case of buildings, properly developed and effectively implemented lifeline seismic standards will significantly reduce the vulnerability of both new and existing lifeline systems to future earthquakes.

The plan will be based on input from private and public sector experts in research and practice of lifeline earthquake engineering. The participants in the planning represent the principal private and public sector organizations concerned with lifeline systems, such as the Technical Council on Lifeline Earthquake Engineering of the American Society of Civil Engineers, associations of utilities, and local, State and Federal governmental agencies. These experts determined that standards are needed to reduce the vulnerability of lifelines to earthquakes, and that adequate knowledge bases exist or can be developed within this decade to produce the standards.

### **I-3. LIFELINES IN THE NATIONAL EARTHQUAKE HAZARDS REDUCTION PROGRAM**

On November 16, 1990, the President signed into law Public Law 101-614, The National Earthquake Hazards Reduction Program Reauthorization Act, which amended the 1977 Earthquake Hazards Reduction Act that established the National Earthquake Hazards Reduction Program (NEHRP). The purpose of the Act is to reduce the risks to life and property in the United States from future earthquakes through the establishment and maintenance of an effective earthquake hazards reduction program. The NEHRP's objectives are:

- The education of the public, including State and local officials, as to earthquake phenomena; the identification of locations and structures that are especially susceptible to earthquake damage; the pinpointing of ways to reduce the adverse consequences of an earthquake; and related matters.
- The development of technologically and economically feasible design and construction methods and procedures to make new and existing structures in areas of seismic risk earthquake resistant, giving priority to the development of such methods and procedures for power-generating plants, dams, hospitals, schools, public utilities and other lifelines, public safety structures, high-occupancy buildings, and other structures that are especially needed in time of disaster.
- The implementation, to the greatest extent practicable, in all areas of high or moderate seismic risk, of a system (including personnel, technology, and procedures) for predicting damaging earthquakes and for identifying, evaluating, and accurately characterizing seismic hazards.

## RECOMMENDATIONS FOR LIFELINE SEISMIC STANDARDS

- The development, publication, and promotion, in conjunction with State and local officials and professional organizations, of model building codes and other means to encourage consideration of information about seismic risk in making decisions about land-use policy and construction activity.
- The development, in areas of seismic risk, of improved understanding of, and capability with respect to, earthquake-related issues, including methods of mitigating the risks from earthquakes, planning to prevent such risks, disseminating warnings of earthquakes, organizing emergency services, and planning for reconstruction and redevelopment after an earthquake.
- The development of the means of increasing the use of existing scientific and engineering knowledge to mitigate earthquake hazards.
- The development of strategies that will ensure the availability of affordable earthquake insurance.

A major accomplishment of NEHRP, with respect to the second objective is the development of the *NEHRP Recommended Provisions for Development of Seismic Regulations for New Buildings* [7]. The recommended provisions have led to the incorporation of up-to-date seismic design and construction provisions in nationally recognized voluntary consensus standards for new buildings and the three model building codes that provide the bases for the building regulations of State and local governments. In addition, these provisions have provided an effective means to implement research results in building practices. Meanwhile, the knowledge needs revealed in developing the recommended provisions have been responded to by the research community. The plan for seismic safety standards for lifelines will be based on this successful experience in cooperative private and public sector activities for building standards in NEHRP.

Moreover, Section 8(b) of the 1990 National Earthquake Hazards Reduction Program Reauthorization Act, Public Law 101-614, states:

*LIFELINES.* - The Director of the Agency [Federal Emergency Management Agency], in consultation with the Director of the National Institute of Standards and Technology, shall submit to the Congress, not later than June 30, 1992, a plan, including precise timetables and budget estimates, for developing and adopting, in consultation with appropriate private sector organizations, design and construction standards for lifelines. The plan shall include recommendations of ways Federal regulatory authority could be used to expedite the implementation of such standards.

In response to this mandate, Federal Emergency Management Agency (FEMA) is supporting the National Institute of Standards and Technology's working with the private sector in the development of the plan.

### **I-4. BACKGROUND FOR DEVELOPMENT OF LIFELINE SEISMIC STANDARDS**

Recent earthquakes in California have demonstrated the vulnerability of lifelines. Modern highway bridges collapsed (see Figure 8), and water supply and electricity (see Figure 9) were lost in the affected areas. In 1974, the American Society of Civil Engineers (ASCE) established



## INTRODUCTION

its Technical Council on Lifeline Earthquake Engineering (TCLEE) to elevate the state of the art of lifeline earthquake engineering. Under the NEHRP, the National Science Foundation (NSF) has sponsored substantial research efforts on lifelines. Since NSF's establishment of the National Center for Earthquake Engineering Research (NCEER) in 1986, NCEER has devoted a major segment of its program to lifelines research.

Because of limited resources, the NEHRP has focused on buildings its initial efforts for development of seismic safety practices. Seismic standards for lifelines have received limited and fragmentary attention. The Federal Highway Administration has supported development of seismic design standards for highway bridges, which have been incorporated in the national standards of the American Association of State Highway and Transportation Officials (AASHTO), and the Interagency Committee on Dam Safety has recommended practices for the seismic safety of dams. TCLEE has produced *Advisory Notes on Lifeline Earthquake Engineering* [8] and *Guidelines for the Seismic Design of Oil and Gas Pipeline Systems* [9], but these are not definitive design and construction standards.

In 1985, FEMA asked the National Institute of Building Sciences (NIBS), the parent organization of the Building Seismic Safety Council (BSSC), to prepare a plan to reduce seismic hazards to new and existing lifelines [10]. Under the direction of a BSSC Action Plan Committee, specialists in all lifeline categories and in legal/regulatory, political, social, economic, and seismic risk aspects of lifeline hazard mitigation were invited to prepare issue papers. Forty-two issue papers were circulated among peers and were the basis of discussions by the 65 participants at a workshop held November 5 to 7, 1986, in Denver, Colorado. The major product of the workshop was an action plan titled *Abatement of Seismic Hazards to Lifelines: An Action Plan* [11].

The plan recommended actions in four areas: (1) public policy, legal and financial strategies; (2) information transfer and dissemination; (3) emergency planning; and (4) scientific and engineering knowledge. Most of the recommended activities concerned the enhancement of scientific and engineering knowledge (e.g., improve geotechnical knowledge; increase knowledge of performance of specific components; develop improved equipment and material for use in seismic resistant construction; develop design criteria, codes and standards of practice for design, construction, and retrofitting of seismic resistant lifeline facilities; etc.). However, the action plan did not focus on systematic development and adoption of seismic design and construction standards for all types of lifelines, new and existing.

In 1989 a NIBS Ad Hoc Panel on Lifelines recommended that FEMA undertake a nationally coordinated program to mitigate the effects of earthquakes and other natural hazards on lifelines [12]. Recommended activities included: awareness and education, vulnerability assessment, design criteria and standards, regulatory policy, and continuing guidance.

As indicated by the NIBS Ad Hoc Panel on Lifelines, "design criteria and standards for lifeline hazard mitigation provide consistent minimum recommended levels of facility engineering design and construction practice. They identify natural hazard abatement techniques and practices for those responsible for all phases of lifeline design, construction, and operation and serve as the basis for model code provisions, which can be considered by local, state, and federal regulatory bodies for adoption into ordinances and regulations."

## RECOMMENDATIONS FOR LIFELINE SEISMIC STANDARDS

### I-5. PLANNING FOR THE DEVELOPMENT OF LIFELINE SEISMIC STANDARDS

The process for the development of the plan was established with the advice of a Steering Group organized by FEMA. The Group, chaired by Ronald T. Eguchi, then Chairman, ASCE Technical Council on Lifeline Earthquake Engineering (ASCE/TCLEE), included representatives from FEMA, NIST, Department of Energy, Interagency Committee on Seismic Safety in Construction (ICSSC), National Center for Earthquake Engineering Research (NCEER), and members from other private sector organizations.

During a March 27 to 28, 1991, meeting the Steering Group approved a process for the lifelines standards development planning. Lifelines experts were engaged as "plan authors" to prepare draft plans for the development of design and construction standards for the various lifeline types. Additional experts for each lifeline type served as plan reviewers. Private and public sector lifelines organizations were invited to a workshop to critique the draft plans and to recommend their integration in the plan. Individual Steering Group members, plan authors, expert reviewers, and workshop participants are listed in Appendix A.

Initial drafts were completed by the plan authors in August 1991 and submitted to the expert reviewers for comments. Based on comments received, second drafts were prepared and discussed at the workshop held in Denver, Colorado, from September 25 to 27, 1991. General priorities for recommended activities were established at the workshop. The findings of the workshop, which comprise the private sectors' recommendations for the planning, are contained in this report.

A draft plan will be submitted to the Office of Management and Budget for review prior to its submission to the U.S. Congress.

### I-6. REFERENCES

1. *Probabilities of Large Earthquakes in the San Francisco Bay Region, California*, Circular 1053, U.S. Geological Survey, 1990.
2. Ibid.
3. *Probabilities of Large Earthquakes Occuring in California on the San Andreas Fault*, Open File Report 88-398, U.S. Geological Survey, 1988.
4. S. P. Nishenko and G. A. Bollinger, "Forecasting Damaging Earthquakes in the Central and Eastern United States," *Science*, Vol. 249 (September 21, 1990): 1412-1416.
5. *Seismic Vulnerability and Impact of Disruption of Lifelines in the Conterminous United States*, ATC-25, Applied Technology Council, 1991
6. *Catastrophic Earthquakes: The Need to Insure Against Economic Disaster*, the Earthquake Project, National Committee on Property Insurance, March 1989
7. *NEHRP Recommended Provisions for Development of Seismic Regulations for New Buildings*, Earthquake Hazards Reduction Series 17, Federal Emergency Management Agency, 1988.

## INTRODUCTION

8. *Advisory Notes on Lifeline Earthquake Engineering*, American Society of Civil Engineers, 1983.
9. *Guidelines for the Seismic Design of Oil and Gas Pipeline Systems*, American Society of Civil Engineers, 1984.
10. *An Evaluation and Planning Report—The Lifelines Segment of the FEMA Earthquake Program*, Federal Emergency Management Agency, September 1989.
11. *Abatement of Seismic Hazards to Lifelines: An Action Plan*, Building Seismic Safety Council, FEMA-142, August 1987.
12. *Strategies and Approaches for Implementing a Comprehensive Program to Mitigate the Risk to Lifelines from Earthquakes and Other Natural Hazards*, A Report to FEMA, Prepared by the Ad Hoc Panel on Lifelines, National Institute of Building Sciences, June 1989.

RECOMMENDATIONS FOR LIFELINE SEISMIC STANDARDS

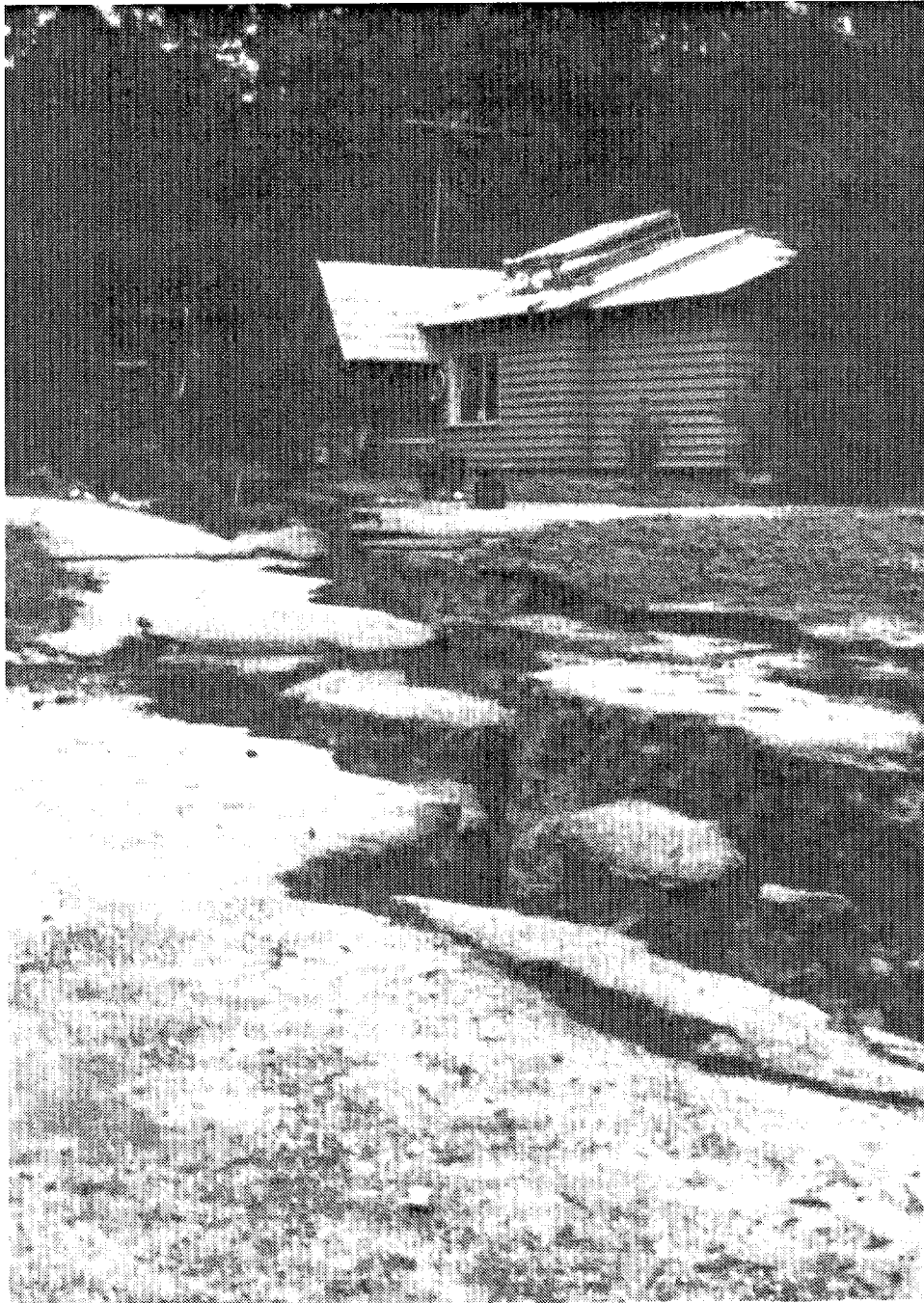


Figure 1. Major crack system adjacent to Summit Road about 0.8 km southeast of Highway 17. View is to the northwest of a wide zone of mostly extensional cracks. Maximum net displacement on these cracks is 92 cm (resolved into 58 cm of extension, 42 cm of left slip, and 59 cm of vertical displacement). Most scarps in this system face uphill (to the left in this photo).



Figure 2a. Four-story building which suffered total collapse of its lower stories (location #3).



Figure 2b. Example of four-story building with multiple garages in the first story (location #1).

*RECOMMENDATIONS FOR LIFELINE SEISMIC STANDARDS*



Figure 3a. Tilting and settlement of apartment buildings in Niigata, Japan, because of liquefaction of the underlying soil during the 1964 Niigata earthquake. Photograph: Courtesy of G. W. Housner.

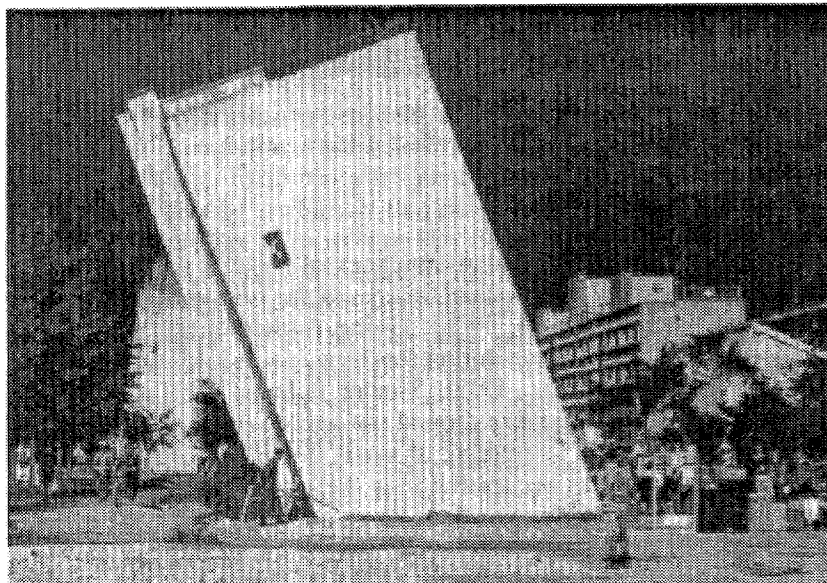


Figure 3b. Close-up view of one of the apartment buildings affected by liquefaction during the Niigata earthquake. Photograph: Courtesy of G. W. Housner.

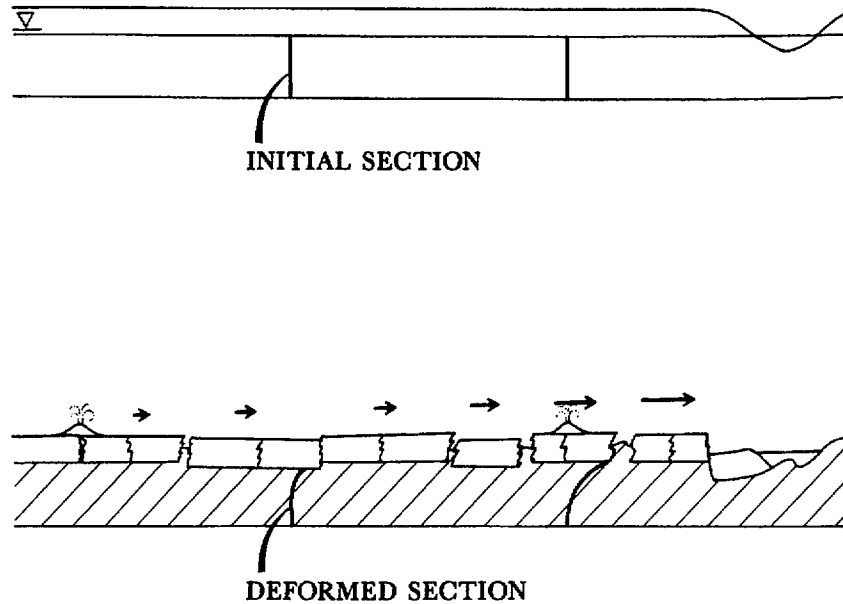


Figure 4a. Diagram of lateral spread before and after failure. Liquefaction occurs in the cross-hatched zone. The surface layer moves laterally down the mild slope, breaking up into blocks bounded by fissures. The blocks also may tilt and settle differentially with respect to one another. Source: Youd (1984b).

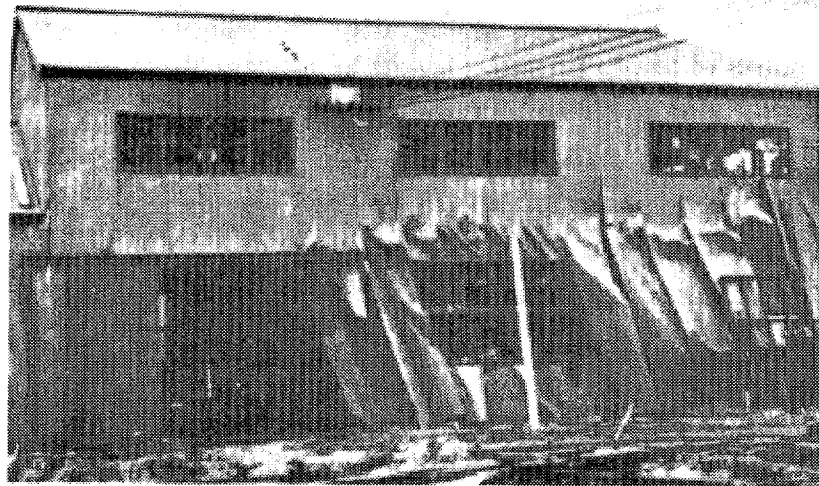


Figure 4b. Building pulled apart by lateral spreading during the 1964 Niigata earthquake. Source: Kawasumi (1968).

*RECOMMENDATIONS FOR LIFELINE SEISMIC STANDARDS*



Figure 5. A 21-story steel frame building that has collapsed onto an adjacent 14-story building in Mexico City, 1985.



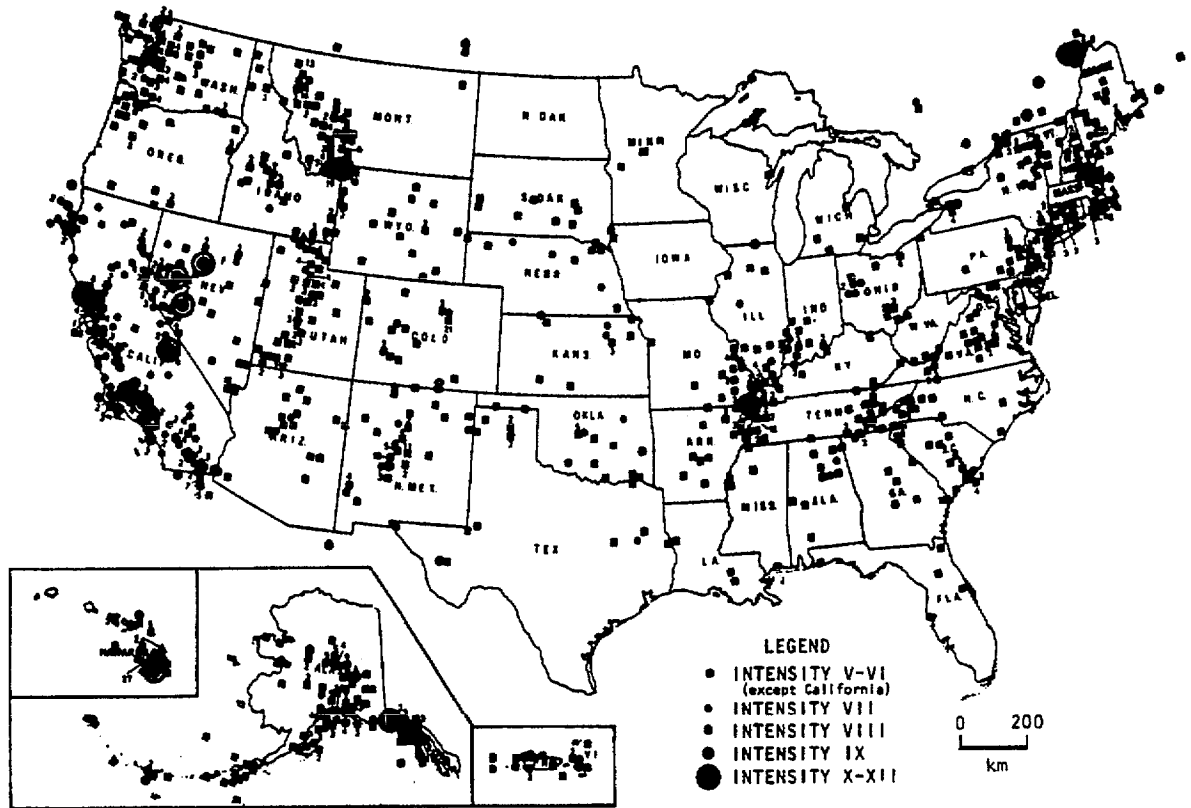


Figure 6. Earthquake with maximum Modified Mercalli Intensities of V or above in the United states and Puerto Rico through 1989 (Algermissen, 1983, with some modifications).

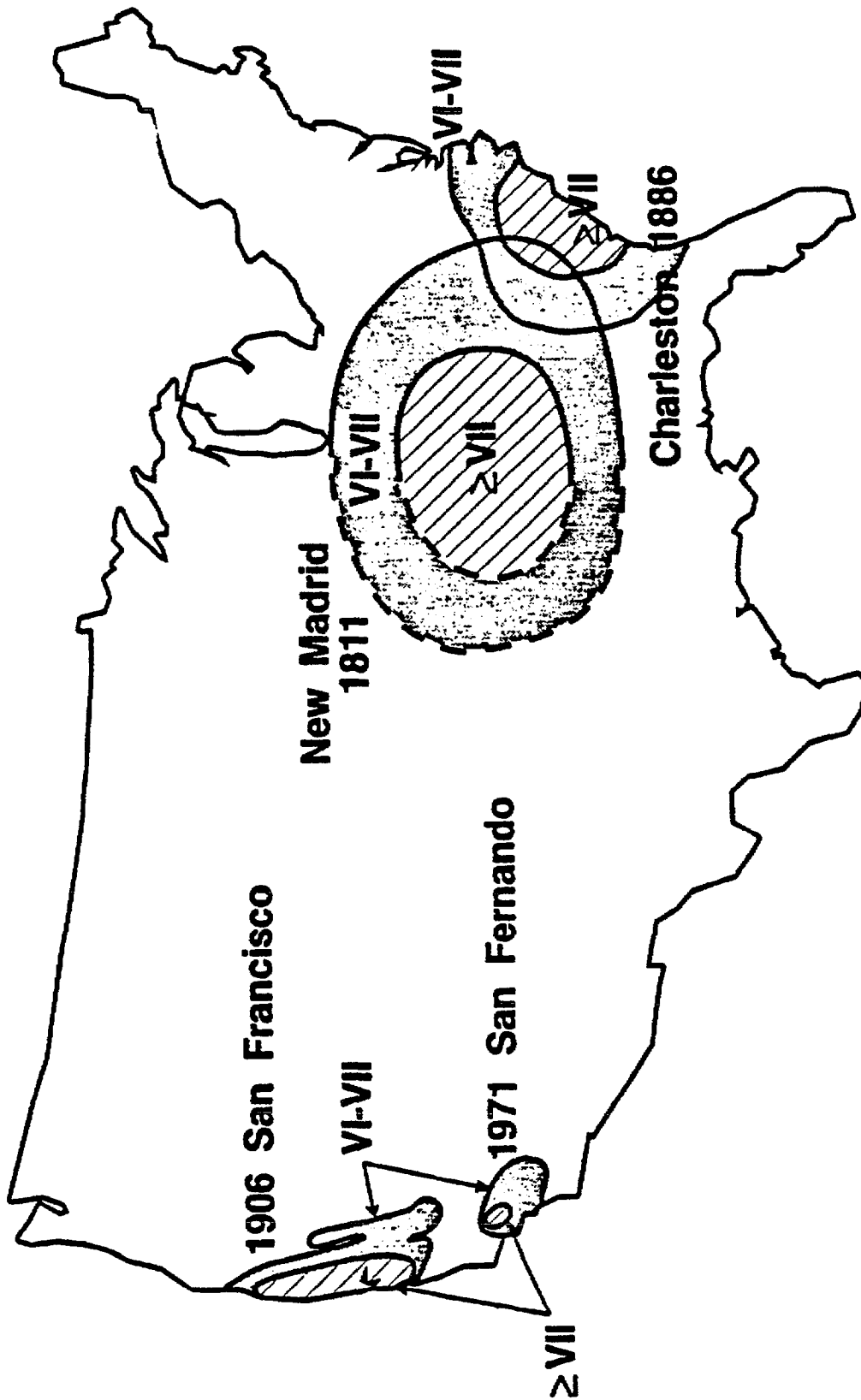


Figure 7. In earthquakes occurring east of the Rocky Mountains ground motions attenuate much less with distance. Therefore, for the same magnitude of earthquake, the area affected in the East can be ten or more times larger than that in the west.

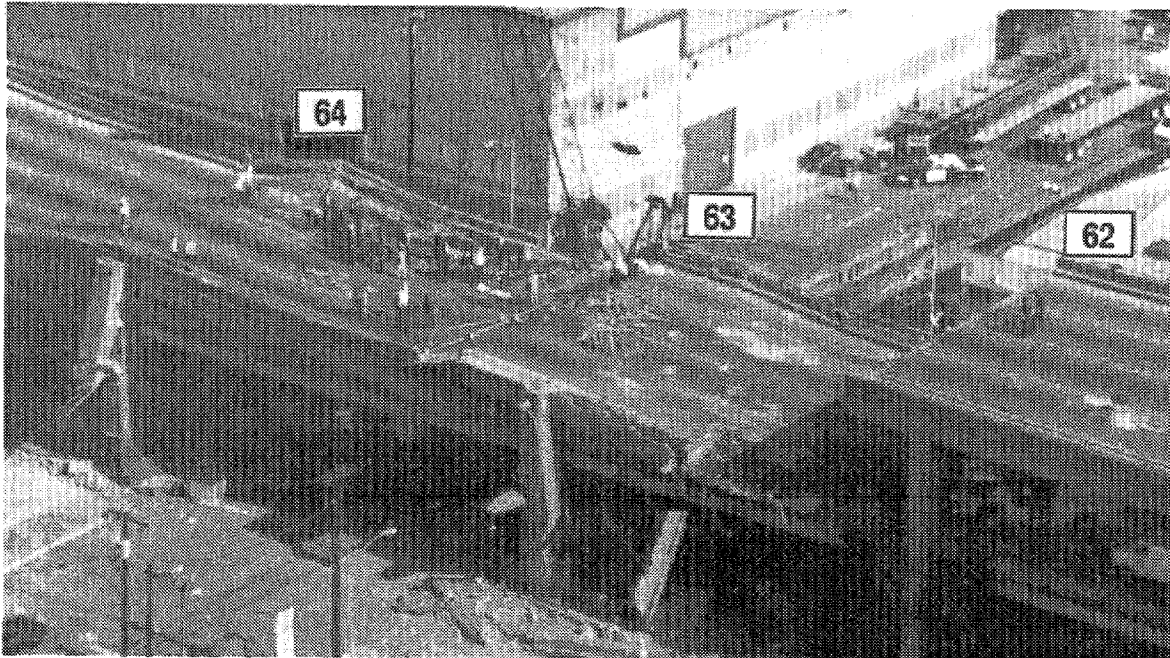


Figure 8a. Aerial photo looking east to the southern limit of the collapsed portion of Cypress Structure between Bents 62-64.

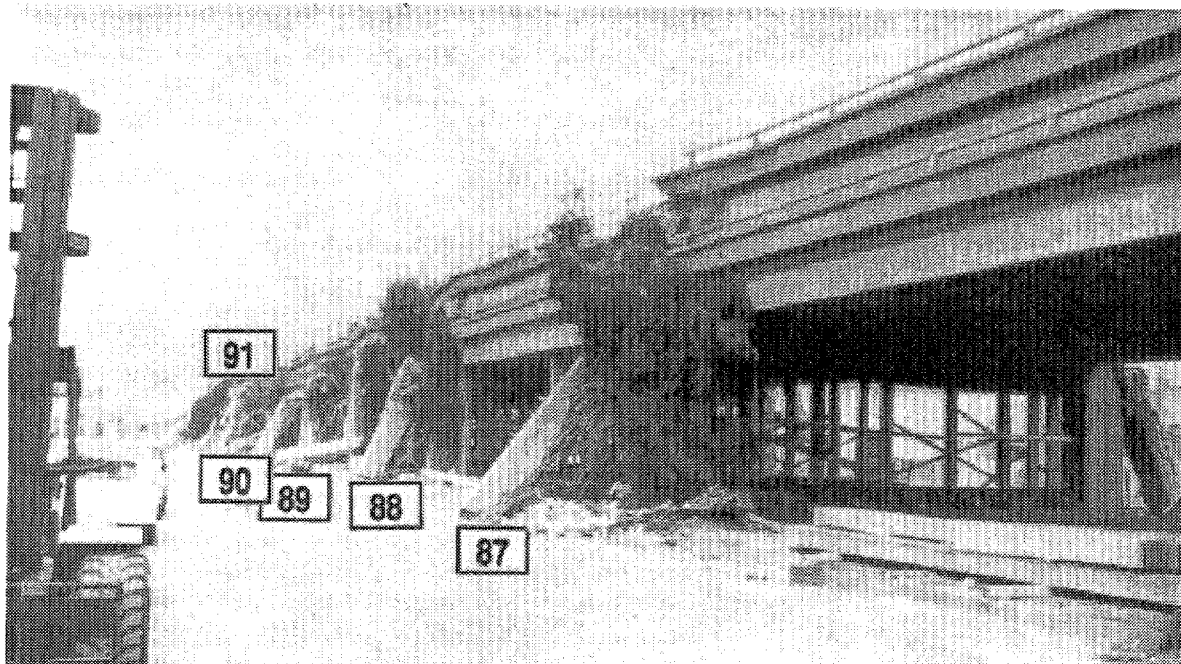


Figure 8b. View of the west side of Cypress Structure looking north between Bents 86-92. These were all Type 1 bents, which demonstrates the uniformity of the collapse mechanism.

RECOMMENDATIONS FOR LIFELINE SEISMIC STANDARDS

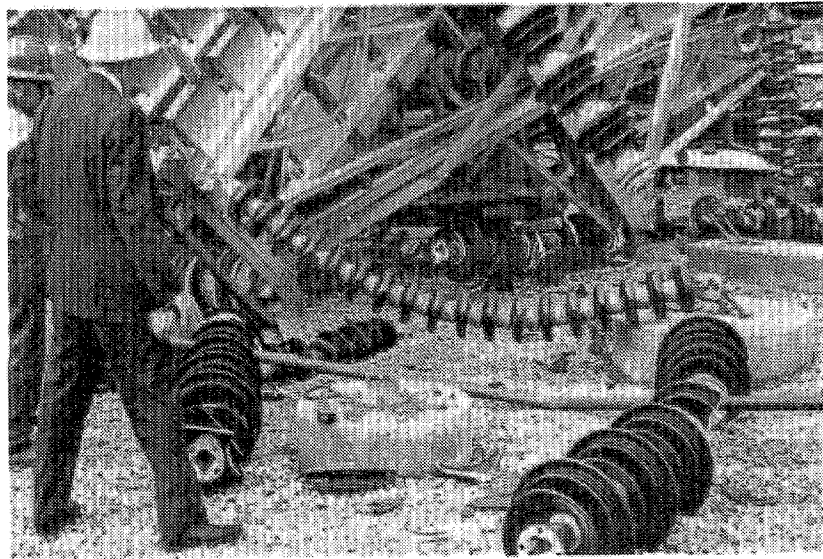


Figure 9a. The electrical power equipment collapsed during the San Fernando Earthquake of 1971. Using research results, improved methods of seismic analysis and design have been developed for electrical equipment that should prevent such disastrous damage from future strong ground shaking. Because such equipment is built of special materials and must satisfy special electrical requirements, optimum methods of seismic design are very difficult to develop.

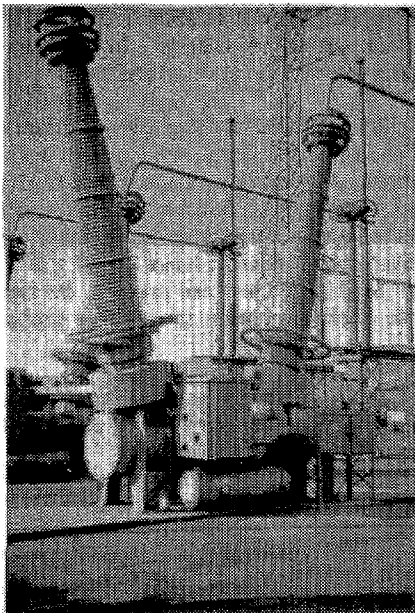


Figure 9b. Dead Tank Circuit Breaker.

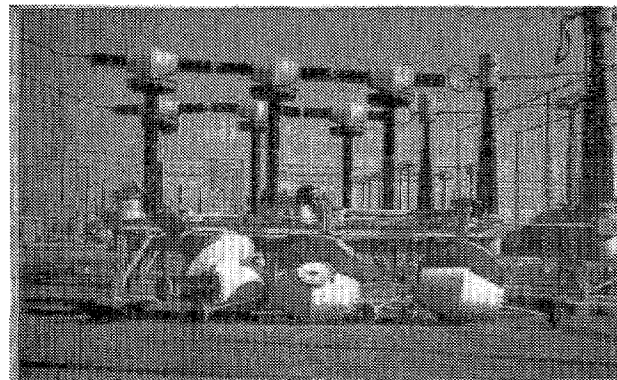


Figure 9c. Older vintage live tank circuit breaker at Metcalf Substation after the Loma Prieta Earthquake.

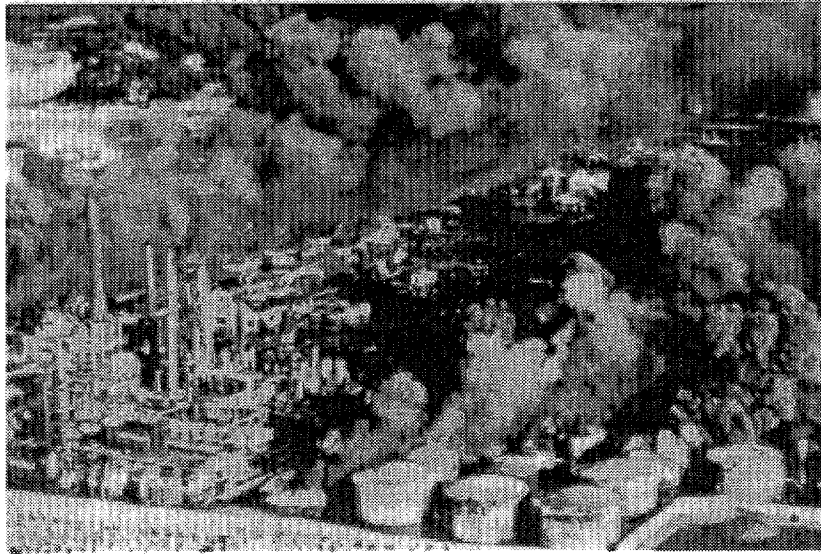


Figure 10. Damage to oil storage tanks during the 1968 Tokachi-Oki, Japan, earthquake led to the release and ignition of petroleum products, resulting in destructive fires.

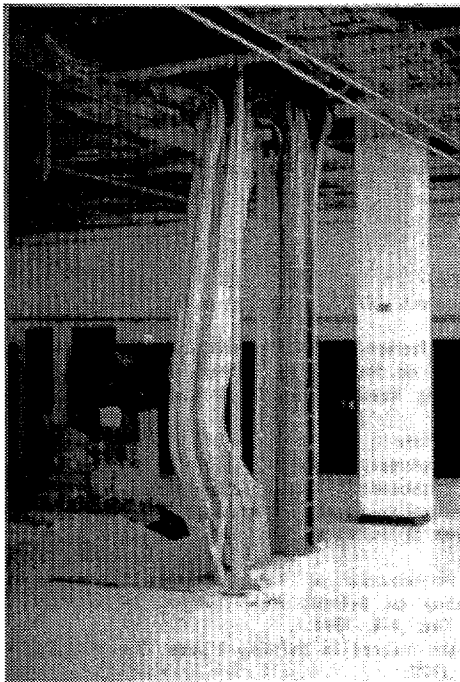


Figure 11a. Oakland CO friction clip failure.

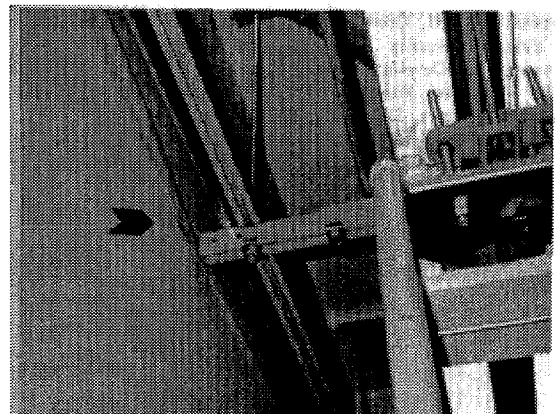


Figure 11b. Conduit pinched by ironworks.

RECOMMENDATIONS FOR LIFELINE SEISMIC STANDARDS

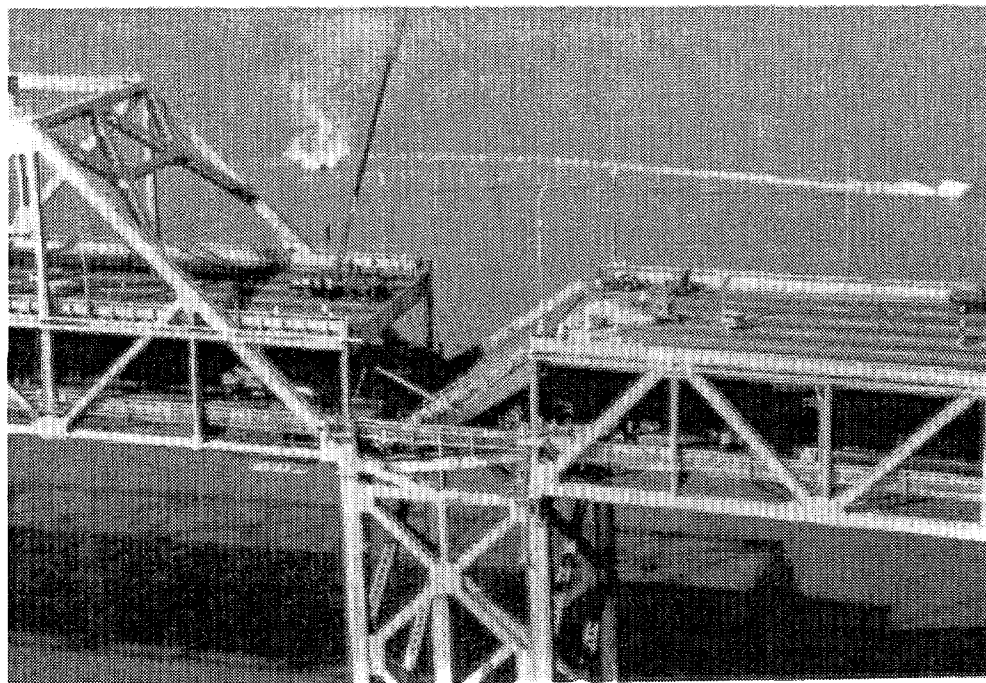


Figure 12a. Aerial photo looking north at pier E-9 on October 19, 1989, showing the collapsed upper and lower 15.1 m deck spans.

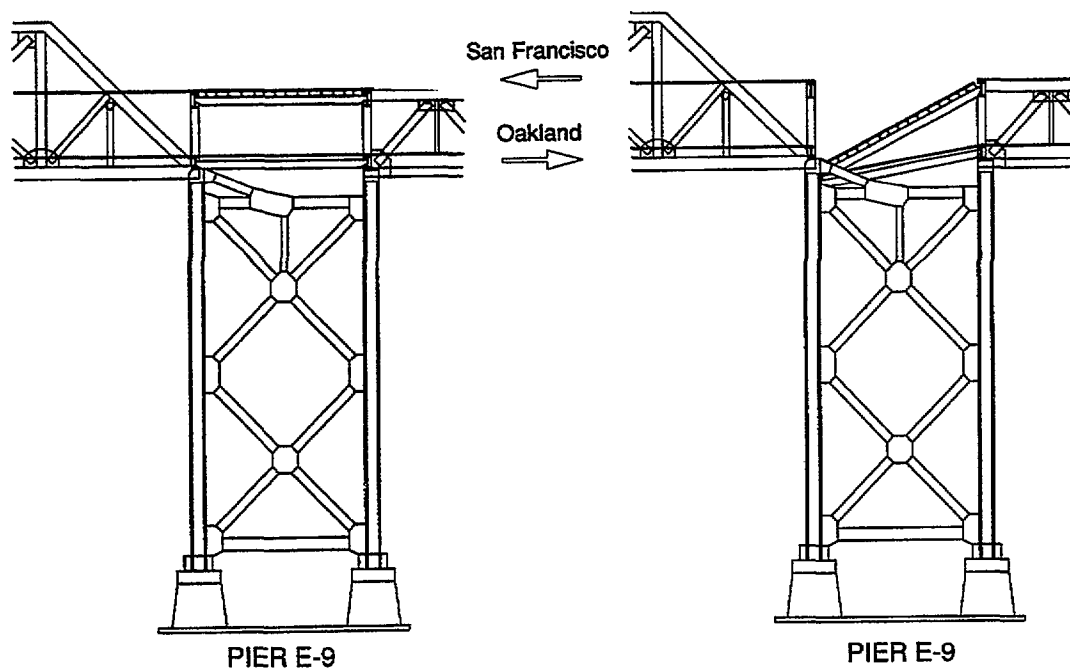


Figure 12b. Schematic detail of Pier E-9 looking north. Evidence indicates that the 88.4 m truss segment on the east side of the pier moved eastward, simultaneously unseating both upper and lower deck segments.



Figure 13. This water hydrant was shattered by the high water pressures generated during the 1971 San Fernando, California, earthquake. The pressures were presumably the result of underground deformations of pipes caused by soil strains. Such damage to the water supply system makes a community vulnerable to uncontrolled fires.

*RECOMMENDATIONS FOR LIFELINE SEISMIC STANDARDS*

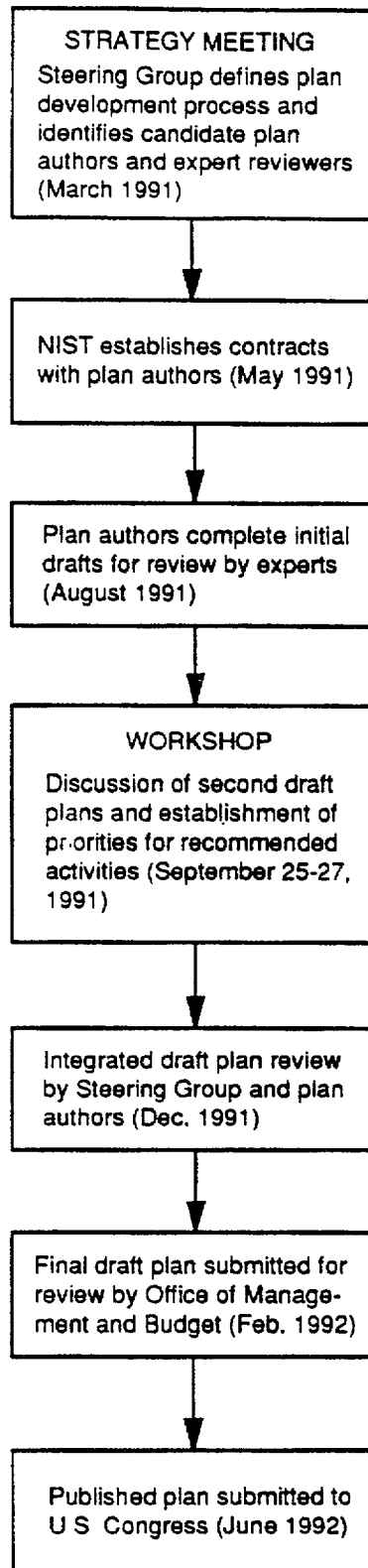


Figure 14. Workshop planning:



---

## CHAPTER II: ELECTRICAL POWER LIFELINES

*ANSHEL J. SCHIFF*

---

### II-1. INTRODUCTION

The purpose of this chapter is to lay out a procedure for developing earthquake design standards for electrical power systems that will limit seismic damage and enhance their postearthquake response and recovery.

The chapter is divided into five sections. Section II-1, "Introduction," discusses the relation of power systems to other lifelines, identifies the primary functions of a power system, and identifies the elements and components that make up power systems and that standards are to address. Section II-2, "State Of The Art," discusses seismic hazards and the seismic vulnerability of power systems, current seismic design practices, and understanding of how power systems respond to earthquakes. Section II-3, "Standards Development," identifies the parts of power system standards and tasks needed for the development of the standards. Section II-4, "References," lists the references cited in the body of the chapter. Section II-5 contains two appendices that contain supporting information for the chapter.

In this chapter, two terms are usually used in a special way. Individual items of equipment or small groups of closely integrated equipment items, such as transformers or circuit breakers, are referred to as components. The components and some functions of the power system have been collected into one of six groupings referred to as power system elements, or elements. For example, the Transmission and Distribution Substation Element includes all substations in a given power system. In addition to the six elements, two procedural functions are discussed.

In many respects power systems are the lifeline to most other lifelines and critical facilities. The fact that there is little or no effective local storage of electrical energy means that when commercial power is disrupted, equipment, systems, and facilities immediately come to a halt. Even critical facilities, such as hospitals, which have emergency backup power, will be significantly impaired if they must operate on their emergency power. Thus, power systems play a very important role in the postearthquake environment.

Of all the lifelines, power systems have most consistently experienced damage from small and moderate earthquakes. Damage has been concentrated in a few classes of very important equipment. The design and construction of power facilities and equipment that have experienced the most damage (high-voltage substations) are not guided by seismic standards or codes, although large California utilities have developed procedures to address earthquake hazards. The performance of most power system components and overall system performance has been good in response to small and moderate earthquakes. However, the pattern of damage suggests that power system response to a large or a great earthquake centered in an urban area would cause long-duration power outages over a large area. To avoid this situation, seismic standards must be established and maintained.

## RECOMMENDATIONS FOR LIFELINE SEISMIC STANDARDS

### II-1.1 Power System Functions, Elements, And Components

Power systems can be viewed from several different perspectives: functions, system elements, or individual components. Each is discussed below.

- **Power System Functions**--These include the following:
  - Power generation
  - Bulk power transmission
  - Power distribution
  - System operation, control, and protection
  - Maintenance
  - System design and construction
- **Power System Elements**--Power systems can be divided into six physical elements for organizing power system operations and evaluating seismic impacts on the system. In this report the term *element* is used exclusively to refer to one of the six parts of power systems defined below. Each element is composed of components, some of which are distributed throughout the system and may be physically located with and integrated into other elements. A description of power system elements and the major components of each is given in Appendix A, "Electrical Power System Elements And Components."

Physical power system elements include the following:

- Power-generating facilities
- Transmission and distribution substations
- Transmission and distribution lines
- Communication (power utility), monitoring, protection, and control facilities (With the exception of the energy control center, most components of this element are distributed throughout the system.)
- Maintenance support facilities (These include maintenance centers and facilities for the storage of spare equipment and parts.)
- Technical support facilities (These include facilities that house design and installation plans and drawings and the engineering staff.)
- Disaster planning and response (These include special provisions in response plans that address seismic issues and the operation of special facilities, such as emergency operations centers and alternate energy control centers. Also note that a distinction is made between emergency response and disaster response. The latter would be applicable to great earthquakes.)
- Postearthquake evaluation (This would include procedures to ensure that the performance of disaster response plans, equipment, facilities, and system response would be evaluated after significant earthquakes.)

## II-1.2 Power System Elements, Components, And Functions For Which Seismic Standards Should Be Applied

Seismic standards should be applied to the following:

- Power-generating facilities
  - Power-generating plants
  - Commercial equipment (*off-the-shelf*)
- Transmission and distribution substations
  - Substations and switchyards
  - Substation and switchyard equipment
- Transmission and distribution lines
  - Transmission line towers
  - Distribution system equipment
- Communication (power utility), monitoring, protection, and control facilities
  - Energy control center
  - Emergency power backup equipment
  - Communication systems and equipment
  - Buildings
  - Emergency operations center
  - Alternate energy control centers
- Maintenance support facilities (service facility and spare parts storage)
- Technical support facilities (buildings engineering documentation)
- Disaster planning and response
  - Seismic components for emergency response plans
  - Recovery plans

## II-1.3 Power System Facilities For Which Seismic Standards Are Not Being Considered

- **Nuclear Steam Generators**--Those parts of a nuclear-power-generating station that are regulated by the Nuclear Regulatory Commission (NRC) would not be subject to the proposed standards. However, step-up transformers, switchyards, and turbine generators associated with nuclear-power-generating stations that are not under NRC purview would be covered by the proposed standards developed for non-nuclear plants.
- **Dams**--Dams used for hydroelectric generation would not be covered by standards to be developed. However, power generating units and associated switchyards would be covered by the proposed standards.

## RECOMMENDATIONS FOR LIFELINE SEISMIC STANDARDS

- **Tanks**--Standards for water tanks will reference those developed in the water and sewer systems, and fuel storage tanks will reference those developed in the gas and liquid fuel systems. It is noteworthy that tank seismic performance has been poor and that improved performance is needed through conservative codes that are strictly enforced.

It is not the intent to duplicate relevant existing standards, but to identify them and incorporate them by reference into the standards documents. Where existing standards do not address seismic issues, they should be supplemented. In the case of building codes, the policy statement for severe earthquakes bars collapse but allows damage. However, some power system buildings must remain operational and must not be evacuated. Current building codes do not adequately address the issue of functionality. The issue of the functionality of buildings is not limited to power systems and should be addressed in a general section that applies to all lifelines as appropriate.

### II-2. STATE OF THE ART

#### II-2.1 Vulnerability

##### II-2.1.1 Limitations In Assessing Power System Vulnerability

The assessment of power system vulnerability is based primarily on observed power system damage in U.S. earthquakes, and to a lesser degree on observations from foreign earthquakes. Observations in the United States have been limited to California, so there is a potential of bias as to the character and extent of damage that might be expected from earthquakes of similar magnitude in other parts of the country. The following factors should be taken into account in extrapolating power systems vulnerability assessments:

- There is no data from a great or major earthquake centered in a modern metropolitan area. The evaluation of system performance is based primarily on moderate California earthquakes.
- Seismic design practices in California have been evolving since the 1920s. Since the 1933 Long Beach earthquake (Schiff 1991a), an impetus has been given to the seismic design of California power facilities. This has been a slow process, and changes in design take a long time to be reflected in most facilities. However, the vast majority of facilities subjected to the earthquakes that have occurred since 1970 have had significantly higher seismic specifications (particularly of equipment anchorage) than most of those types of facilities outside California. Wind and ice design loads may control design in some regions; however, these requirements typically do not improve the seismic performance of high-voltage power equipment, the primary source of power system earthquake damage.
- An earthquake occurring in most regions outside of California would affect a larger area than an earthquake of the same magnitude occurring within California because of the lower attenuation of seismic waves outside California. As a result, a larger number of substations might be affected by an earthquake, and the redundancy in the power network might be overwhelmed.
- Extensive liquefaction was observed after the 1811 to 1812 New Madrid earthquakes

and is expected in other eastern events. Liquefaction may cause more damage to power-generating facilities than has been observed in California.

- California and many other seismically active regions of the world do not have coal-fired generating stations, so the seismic performance of these facilities is untested. Coal-fired plants are larger than equivalent-capacity, gas- or oil-fired units, and they have heavy, coal-storage silos located high in the boiler support structure. Some coal-handling equipment is poorly designed to withstand earthquake excitations.
- Some power systems outside California have higher operating voltages. The seismic vulnerability of substation equipment (especially porcelain members) increases with its operating voltage. The highest operating voltage in California is 500 kV, while in other regions of the country 765 kV equipment is used. The seismic vulnerability of the 765 kV equipment is not known, but it is probably higher than the 500 kV equipment.

### **II-2.1.2 Basis For Evaluating Power System Vulnerability**

There has been significant damage to power system components in many earthquakes; therefore, the vulnerability of power system components is based on earthquake experience rather than on analysis. Appendix B, "Summary Of Earthquake Power System Damage," briefly summarizes power system damage in recent earthquakes.

Earthquakes have also shown that substation equipment operated at 115 kV and below performed well when anchored. Also, a broad range of small-size, commercial equipment (units that are shipped assembled experience shipping loads that are often more severe than earthquakes) used in substations and power plants performed well adequately anchored. Examples of well-anchored equipment that have performed well are pumps, motors, motor control centers, switchboards, and motor-operated valves. Cable trays have also performed well when standard industrial practices were used in their design and construction.

### **II-2.1.3 Impact Of Seismic Hazards On Power Systems**

Knowledge of the effects of earthquakes on power systems has been gained from observing earthquakes that have occurred in many parts of the world. The significance that any effect has for a particular region depends on the characteristics that prevail there. Each of the following sections will discuss one of the major effects of earthquakes, with an emphasis on those effects that are most important to power systems.

- **Ground Vibration--**When an earthquake occurs, seismic energy radiates away from the causal fault in the form of seismic waves. These waves cause transitory strains in the ground. Objects embedded in the ground, such as conduit and piping, will be subjected to these strains. The effect of these strains on buried electrical facilities are usually not significant.

When seismic waves reach the ground surface, they will induce vibration in the structures and equipment resting on the ground. In general, the severity of the ground's shaking decreases as the distance from the source increases; however, local soil conditions and topography can significantly change the character of the ground

## RECOMMENDATIONS FOR LIFELINE SEISMIC STANDARDS

motion. As the depth and softness of the soil at a site increase, the low frequency content of the ground motion is amplified and the high frequency content tends to be attenuated. Vibration levels at bedrock may be amplified by a factor of three or more at the surface. The effect of induced vibration is the major cause of power system damage.

- **Soil Liquefaction**--Under certain conditions, when soils experience vibrations, their shear strength decreases and soil liquefaction occurs. Liquefied soil has been observed to flow on 1 percent grades, and surface-supported structures have settled few meters below grade. In some cases, buried tanks have floated to the surface. While significant vertical ground deformations are frequently associated with soil liquefaction, extensive horizontal spreading has been observed. Liquefaction can severely impact buried facilities and structures supported on unstable soil. Most bulk power transmission uses aerial lines so that liquefaction would primarily affect isolated locations, such as transmission tower foundations, substations, or power-generating stations. In the few cases where power facilities were directly affected by liquefaction, its consequences were minor. In newer communities, power distribution systems are frequently buried and thus are more vulnerable to the effects of liquefaction. The impact of liquefaction on the distribution system will be local power disruptions, and the effect on other structures in the area will probably be more severe.
- **Earthquake-Induced Landslides**--There are many regions in which earthquake-induced shaking triggers landslides. The topography and soil conditions are the primary control variables, but should the earthquake occur during a rainy season when soils are saturated, the situation can be aggravated. Slides can cause excessive deformations in the ground, and the motion of the soil may sweep away structures and equipment in its path. Landslides have not had a significant impact on power systems in the United States.
- **Subsidence**--Under certain conditions, an earthquake may cause extensive settling of the ground. In past earthquakes this has caused flooding and differential settlement. This can cause severe damage to buried utilities, such as water, gas, and oil lines, but its impact on power systems has not been significant.
- **Ground Faulting**--Faults are fracture planes where there is relative motion between the rock on each side of the fracture. In areas with multiple fractures the area is referred to as a fault zone. Anything spanning the fault, such as buried pipe or cable or a structure, can experience severe deformations and loads. Depending on the earthquake, the motion across faults can be both horizontal and/or vertical. Offsets across faults can be quite large. The largest fault associated with the 1906 San Francisco earthquake was 6.1 m. In some earthquakes, particularly in the eastern United States where there are deep alluvial deposits, the faulting may not extend to the ground surface so faulting is not observed. Faulting has not had a significant impact on power systems.
- **Earthquake-Induced Water Waves**--Earthquakes occurring off shore that have vertical components or cause large subterranean landslides can generate large, long-period waves, called tsunamis. Typically, these waves are barely perceptible in deep water; however, with certain types of shoreline topographies they can generate massive waves when encountering a land mass. These water waves travel great

distances at speeds of about 500 miles per hour with little attenuation. As a result, waves generated thousands of miles away can create havoc when they reach the distant shore. For example, in 1964, Crescent City, California, was devastated by water waves generated in the Alaska earthquake. In addition, water levels have been observed to rise over 4.6 m and can extend inland more than a kilometer. Tsunamis have not had a significant impact on power systems; however, many power-generating stations are on shore lines and may be vulnerable.

#### II-2.1.4 Methods For Vulnerability Evaluation

Three approaches to the seismic evaluation of power systems are discussed below. They are (1) studies of high-seismic-risk areas, (2) computer-based network analysis and estimates of equipment fragility, and (3) scenario hypothesis. Not considered here were the early evaluations done by utilities that focused on power system component vulnerabilities rather than system evaluation.

- **Studies Of High-Seismic-Risk Areas**--Studies of regions with moderate to high seismic risk have yielded several estimates of power system damage and disruption. Studies have been conducted in Los Angeles, San Francisco (NOAA 1972), Salt Lake City, Seattle, and the New Madrid areas. Details of the methodologies used in these studies are not well documented. They are based on extrapolations from aggregated data from past earthquakes, but they do not consider any of the details known to be major contributors to power system vulnerability (high-voltage substation equipment and installation practices) or network configurations. A series of meeting proceedings includes several papers that address evaluation and current practices, but they share the above shortcomings (Benfer 1973; Duke 1977; ASCE 1983; Smith 1981; ASCE 1987; FEMA 1987a; FEMA 1987b).
- **Computer-Based Network Analysis And Estimates Of Equipment Fragility**--Several computer-based approaches to power system vulnerability have been based on network analysis and estimates of equipment fragility (Schiff 1979). Most of these studies are severely flawed in that the fragility used to characterize power facilities are aggregated so that vulnerabilities have little or no meaning. The models used to characterize the networks consider connectivity rather than power flows. The reconfiguration of the networks to accommodate unusual power flows is not done. A recent effort to evaluate seismic performance of power systems on a regional basis is severely limited. It characterizes power networks without considering operating voltages or power circuits but only power line right of ways. The analysis has little bearing on actual system performance (ATC 1991). Because these models aggregate power system facilities and equipment, the results cannot be used to identify vulnerable equipment or evaluate the impact of mitigation measures. One methodology did take into account the above factors, but its implementation was very data intensive (Schiff 1976).
- **Scenario Hypotheses**--Methods currently used by utilities to evaluate their power systems are typically based on a scenario approach, that is, specific seismic events are hypothesized. Substations are evaluated by reviewing specific equipment items based on engineering judgment and observations of damage from past earthquakes, and vulnerable items are assumed to be damaged. The "damaged" system is then reviewed by operating personnel to determine the impact of the damage on system operations. While these methods are informal, vulnerabilities of specific equipment at specific

## RECOMMENDATIONS FOR LIFELINE SEISMIC STANDARDS

sites are identified, and the results can be used in several ways. Direct losses can be estimated. Critical points in the system can be identified, and this information serves to establish mitigation measures and upgrading priorities.

### II-2.1.5 Overall Evaluation Of Power System Vulnerability

One can say that power system seismic performance, as measured by power disruption, has been very good for the small and moderate earthquakes experienced to date. Thus, network redundancy has been adequate to overcome the extensive damage to isolated high-voltage substations. In the case of the Loma Prieta earthquake, where several substations were damaged, the character of the damage and the use of emergency procedures allowed most service to be restored in less than one day.

Damage to power distribution systems has also occurred, but this only caused localized disruption. Its occurrence is not well documented.

The extrapolation of power system performance to large and great earthquakes must be tempered by the caveats discussed in the Section II-2.1.1, "Limitations In Assessing Power System Vulnerability."

### II-2.1.6 Seismic Evaluation Of Power System Elements

Section II-1.1, "Power System Functions, Elements, And Components," defines six elements that can be used to categorize the physical parts of power systems. The first five of these elements are equipment intensive, and their performance in past earthquakes has been documented (Schiff 1991e) and is reviewed below. In addition, the performance of major components that make up each element is briefly reviewed. Appendix A, "Electrical Power System Elements And Components," briefly describes each of these elements, major components within each element, and their function within the power system. It is primarily on the basis of past performance of power system component that the scope of standards is determined.

#### II-2.1.6.1 Power-Generating Facilities

In general, the overall seismic performance of power-generating stations has been good, although as noted earlier, coal-fired plants and large oil- and gas-fired plants (500 MW and above) have had limited exposure. The Moss Landing Generating Station (oil- or gas-fired) experienced significant shaking during the Loma Prieta earthquake and survived with limited damage, although the unit operating at the time of the earthquake was put out of service.

Power station performance of facilities outside the United States, primarily in Chile and Japan, has also been good. However, a small generating station in Managua, Nicaragua, was severely damaged in 1972 (EERI 1973).

While overall generating-station performance has been good, equipment and facilities have been damaged, and some components, such as water and liquid fuel storage tanks, have performed poorly. Damage can be grouped into five categories of equipment or facilities: turbines, steam generators, commercially produced equipment, engineered equipment, and structures. The black start capability, that is the ability of a generating station to start with the loss of all offsite power and all systems in the station down and cold, is also discussed below.

- **Turbines**--Most turbine problems are associated with longitudinal motion of the



## ELECTRICAL POWER LIFELINES

turbine rotor relative to the turbine housing or the loss of station and emergency power during turbine shutdown.

Longitudinal motions can exceed the capacity of turbine thrust bearings resulting in their being wiped. This will require early maintenance, but the turbine can usually continue to operate for some time. If the relative motion is larger, moving and fixed blades will come in contact and major damage will result, causing very long repair times. Frequently, the power house is a steel frame structure and is relatively flexible when compared to the turbine pedestal. In addition, the construction joint between the turbine pedestal and the operating floor may have been inadequate to prevent impacting, which can cause damage to the turbine (see Figure 1).

Turbine bearings have also been damaged due to the loss of offsite power (often as a result of damage to the switchyard) and the simultaneous failure of station power (station generator, batteries, and/or emergency generator). When the switchyard is damaged, the generator trips and the turbine coasts to a stop. Without station power, lubricating oil pumps do not operate and the bearings can fail. Also, without station power, the turning gear does not operate and the turbine rotor shaft sags and takes a permanent set as the turbine cools.

- **Steam Generators--**Disruptive damage to steam generators has been associated with broken boiler tubing. Other damage has been associated with the relative motion between the suspended boiler and its support structure. The tube damage is associated with inadequate internal bracing. Damage due to the relative motion between the boiler and its support structure is primarily due to inadequate horizontal bracing between the boiler and the support structure. While these features are part of the basic design, the external features are more amenable to repair. There has been very little damage to major steam piping, although snubbers have been damaged. It is noteworthy that these facilities use very few piping restraints and snubbers as compared to nuclear generating plants. Most piping damage is to small pipes with inadequate flexibility connected to large pipes.
- **Commercially Produced Equipment--**The term *commercially produced equipment* means equipment that is produced to a standard design used by a manufacturer (off-the-shelf). Examples would be pumps, motors, motor control centers, and low- and medium-voltage switchgear. This type of equipment has generally performed very well in earthquakes. Most problems have been associated with inadequate anchorage. The anchorage on some equipment, such as pumps and motors, which have relatively high service loads, performs well in earthquakes since normal operating loads exceed earthquake loads. This equipment, which is shipped assembled, usually performs well if it is anchored since the shipping loads can exceed earthquake loads.
- **Engineered Equipment--**The term *engineered equipment* means equipment that is designed on a plant-specific basis. Examples of this would be coal-handling equipment, cable trays, piping systems, duct work, and large blowers and fans. In general, this type of equipment has performed well. Standard industrial practice has yielded very good seismic performance of cable trays and piping. Coal-handling equipment has not had much seismic exposure, but a

## RECOMMENDATIONS FOR LIFELINE SEISMIC STANDARDS

review of some facilities suggests that some design details would be subjected to earthquake damage. Damage to engineered equipment often is associated with relative deflections between different structures that the equipment spans. As noted earlier, large unanchored tanks have not performed well. Bases of these tanks can lift, and poor or corroded welds at the sketch plate can fail (see Figure 2), or piping with inadequate slack can fail. Rapid loss of liquid contents can cause the tank to implode (see Figure 3). Failure of fuel-oil tanks creates a fire hazard, and berms that surround tanks to contain spills may not have adequate capacity for multiple-tank failures. This can result in a spill in an adjacent body of water. Leaks can also affect the operation of the entire plant due to fire hazard (Schiff 1978).

- **Structures**--Structural damage to power plants has been very limited. Isolated members have buckled and some connections have failed, but the operation of the plant was not affected and damaged members were easily repaired. Good performance is probably related to steel-frame construction that provides a high degree of damage tolerance. Damage is common to seismic stops on the boiler support structure (see Figure 4) and large steam pipe restraints (see Figure 5). The seismic stops are used to limit the lateral motion of the suspended boiler. The stops may be severely deformed or totally ripped from the structure, but they are easy to repair. One problem is that the thermal growth of the suspended boiler may cause seismic stops to become misaligned. Piping restraints have been damaged but the piping itself has not been damaged. Damaged pipe restraints are easily replaced.
- **Black-Start Capabilities**--Some power plants are designed to be able to start when the generating unit is in a cold condition and without off-site power (black-start capability). This capability is important in restoring service after extensive system disruption. Units designed with black-start capabilities have had some critical circuits not connected to emergency power. As a result, the units could not be started until off-site power was restored to the plant.

### II-2.1.6.2 Transmission And Distribution Substations

Substations usually consist of a control house, bus (conductors used to carry power between equipment and throughout the substation), bus support structures, circuit breakers, power transformers, disconnect switches, capacitive-coupling voltage transformers, current transformers, lightning arrestors, wave traps, and other equipment. The control house contains protective relays, control circuits, control panels, status indicator boards, cable trays, communications equipment, station batteries, and other equipment. Manned substations will also have operation stations and control panels for personnel.

The vast majority of power system earthquake damage has been to porcelain members on high-voltage substation equipment. Equipment operating at voltages of 115 kV and below performed very well when adequately anchored. Equipment operating at 220 kV and above experienced damage; the higher the operating voltage, the more vulnerable the equipment, due to the size of porcelain members. The highest-voltage equipment in the United States to be subjected to significant ground motions is 500 kV, although there is equipment operating as high as 765 kV outside California. In Canada, equipment operating at 735 kV was damaged by an earthquake (Pierre 1989).

Several types of failures associated with porcelain have been observed. Leaking or broken bushings and broken post insulators are common. Lack of slack in busses connecting equipment can load and damage bushings and post insulators as a result of earthquake-induced relative motions. Flexible equipment supports have allowed large relative displacements, which tends to aggravate the lack of slack. Inertial loads can also cause failures. Some equipment designs appear to be inherently vulnerable, for example, live-tank circuit breakers, while other equipment that serves the same function and operates at the same voltage can be quite rugged, for example, dead-tank circuit breakers. Lightning arrestors are frequently damaged, but they can be temporarily bypassed without disrupting system operations. Current transformers and capacitive-coupling voltage transformers have been damaged, and their loss of function can disrupt system protection.

In addition to porcelain damage, inadequately anchored transformers have fallen from their elevated supports and have been severely damaged (see Figure 6). Large transformer radiators supported from a manifold tend to develop oil leaks.

One of the main difficulties when substation equipment is damaged is that there are limited numbers of spare parts or spare replacement equipment. Also, repair and replacement of damaged equipment are a time-consuming task.

The equipment items listed below are organized in the order of the frequency with which they are damaged and the importance of their damage to system operation. The types of damage to the equipment and the factors that may have contributed to it are briefly discussed.

- **Circuit Breakers**--Circuit breakers are probably the most vulnerable equipment item in a switchyard, and they have exhibited several failure modes, most closely related to their design and details of their installation.

Live-tank circuit breakers are designed with the tank that holds the interrupting mechanism at line voltage. As a result, the interrupter head is supported on a porcelain column. There are several designs, each of which has several failure modes. The most severe failure is associated with failure of the porcelain interrupter/head support column. This results in the collapse of the interrupter head and the potential of damage to adjacent equipment connected to the circuit breaker (see Figure 7). These units have failed at ground accelerations as low as 0.05g. Circuit breakers of this design are commonly used at higher operating voltages. Until recently, live-tank circuit breakers cost about two thirds to one half that of dead-tank circuit breakers.

Dead-tank circuit breakers consist of a tank that contains the interrupting unit. They derive their name from the fact that the tank that holds the operating mechanism is at ground potential. The tank is supported on a steel support structure near the ground. Two porcelain bushings provide electrical connections between the bus and the interrupter in the tank. The tank is usually filled with an insulating gas. The seismic performance of these units has been very good.

A bulk oil circuit breaker (OCB) consists of a large tank filled with oil that has two bushings where the circuit enters and leaves the tank. OCBs are usually distinguished from dead-tank breakers, even though they are a type of dead-tank breaker. Their seismic performance is good, although friction clips used to anchor the circuit breaker frequently fail. Those are rarely found at the highest operating voltages.

## RECOMMENDATIONS FOR LIFELINE SEISMIC STANDARDS

Most substations are designed with extra circuit breakers, so that loss of a single circuit breaker has no effect. When earthquake damage occurs, several of the vulnerable circuit breakers at the site frequently fail so that there can be lengthy delays to repair the damaged units or move in replacement units from other sites. Even when spare parts are available, repairing a damaged circuit breaker that has lost its support column will require several days to a week. Under extreme conditions, where many circuit breakers are damaged, the circuit breakers can be bypassed and protection provided by circuit breakers at another substation. This provides poorer protection, and there is the potential of damaging other equipment, such as transformers, if there are system problems, which might occur in an aftershock.

- **Transformers**--Transformers have experienced several types of failures; many are associated with inadequate installation practices. The major problem is that older units are inadequately anchored to their foundation pads and move, causing damage to lightning arrestors or bushings (see Figure 8). While many regions no longer rail-mount transformers, many old rail-mounted units can still be found. Most new installations place the transformer on a concrete pad. However, in many regions of the country the transformer is still not anchored. As a result of transformer movement, bushings, lightning arrestors, control cable connections (see Figure 9), and bus connections can be damaged. If transformers fall from their platforms, they can damage radiators and cause internal damage to themselves. Inertial loads can crack bushings or cause them to shift and leak (see Figure 10).

Minor radiator leaks are frequently observed, but major leaks, while uncommon, have put units out of service. This appears to be associated with units in which several radiator sections are mounted to a manifold. Leaks occur at locations where the manifold is connected to the transformer tank. Older transformers may use PCB as a dielectric material, and their failure may result in leakage of materials that present a special cleanup problem. There have been several cases where transformer bushings have leaked, and in the Sendai, Japan, earthquake, bushings on each of five three-phase transformers failed.

Transformers can also suffer internal damage due to shifting of the core and motion of cable harnesses.

Frequently, transformer-mounted lightning arrestors fail. Failed lightning arrestors can damage transformer bushings when they fall.

The loss of a transformer prevents power from being transferred between different voltages. There is no way to bypass a transformer as can be done with other substation equipment. Their loss will typically impair the system.

- **Capacitive-Coupling Voltage Transformer (CCVT)**--These devices usually consist of a porcelain column mounted on top of a metal box. They are used to convert transmission and distribution voltages to lower voltages to feed metering and control devices. The information that these devices provide is very important for the control and protection of the power system.

## ELECTRICAL POWER LIFELINES

Units operating at voltages of 220 kV and above have frequently failed at the base of the porcelain column. Factors that may contribute to their failure are inadequate slack in electrical connections, dynamic response in the bus making electrical connections, and inertial loads. For pedestal-mounted units, the dynamic amplification of the support structure may amplify the motions and loads on the CCVT.

Damaged CCVTs must be bypassed, which requires personnel and time. Their loss will significantly downgrade system protection.

- **Current Transformer**--Current transformers measure the current in a circuit and are used for system control and protection. Current transformers consist of a bushing on top of a box that usually has its own support structure. Circuit breakers may have a current transformer incorporated into their design.

Three types of damage have been common. The porcelain column can fail (see Figure 11), seals at the base of the porcelain column can fail allowing oil to leak, and bus connection hardware fails. Oil leaks may require extensive cleanup.

Damaged current transformers can be removed from the system; however, the quality of system protection will typically be significantly degraded. Working around damaged units takes personnel and time.

- **Disconnect Switch**--Disconnect switches are used to open a de-energized line or to isolate or bypass an equipment item, such as a circuit breaker. There are several types of disconnect switches. Disconnect switches use post insulators in their fabrication.

Three types of failures have been observed. The post insulator used to fabricate a unit can fail (see Figure 12), the metal mechanism that causes the switch to open can fail, and units can become misaligned so that they will not open or close.

Damaged disconnect switches can be bypassed if a connection is needed or disassembled if they are to remain open. Working around damaged units takes personnel, and time and flexibility, to modify the system.

- **Lightning Arrestor**--Lightning or surge arrestors limit the voltage on a circuit. In external appearance they are similar to post insulators. They can be supported on their own ground-mount support column or are frequently supported on transformers.

Failure of lightning arrestors has been quite common and usually occurs at the sand ring, the lower portion of the porcelain used to bond it to its metal mounting flange. Factors contributing to their failure may be dynamic amplification of their support structures or lack of slack in power connections.

The loss of lightning arrestors will not have a significant effect on the system. It will have to be bypassed if it is damaged, and it will reduce protection. Also, it may strike and damage other equipment when it fails.

- **Wave Trap**--A wave trap is an inductor in the form of a large hollow coil. It

## RECOMMENDATIONS FOR LIFELINE SEISMIC STANDARDS

prevents high-frequency carrier signals superimposed on transmission lines from reaching equipment in the substation.

The failure of wave traps is usually associated with the failure of post insulators used in their fabrication. Factors that can contribute to failure are inadequate conductor slack to adjacent equipment or increased inertial loads associated with the dynamics of the support structure.

The loss of a wave trap will reduce a signal path used for system protection. In general, its loss will reduce system protection.

- **Bus And Bus Supports**--The conductors used to make power connections within a substation are referred to as *buses*. Buses are usually made of aluminum pipe (rigid buses) or flexible aluminum cable (flexible buses).

Several types of failures have been associated with the different types of buses. Both rigid and flexible buses supported on column structures have had post insulators fail, dropping the bus to the ground. Buses are frequently not provided with adequate slack so that seismically induced relative motion between equipment and bus support structures causes failures. Also, the dynamic response of the vertical drops or the dynamic response of the main lines may load equipment bushings connected to buses and cause failures.

Buses are needed in the substation. While there may be some redundancy, and a few isolated failures can be worked around, significant damage will be very disruptive. With personnel, materials, and time, work-arounds are possible.

- **Substation Control Structure And Its Contents**--In general, control house structures have performed well seismically since they are typically small simple structures. While they conform to building codes, in much of the country the codes have inadequate seismic provisions. Older, unreinforced masonry structures, built before the adoption of current seismic provisions, have been damaged, some very severely (see Figure 13). There have been cases where unmanned control houses were severely damaged, but the equipment inside continued to function. (Had the control house been manned, it would have been evacuated.) Collapse of the control house could severely damage vital equipment and put the entire substation out of service.

Problems are common with several items frequently found in substation control structures. Station batteries fall from their racks, or their cases crack from impacts within the rack due to inadequate anchorage and restraint. Some types of protective relays can be actuated by earthquake-induced vibrations. This may cause some unwanted actions and temporary disruption at a substation, but no damage to systems is known to have occurred as a result of spurious relay actions. After an earthquake, relays may have to be reset to resume operations. Flags on relays often vibrate to indicate a change in state when the associated relay may not have operated. There has been severe damage in reactivating a substation when indicator warnings were assumed to be from spurious seismic action. There have also been problems with ceiling panels and light fixtures mounted in suspended "T" bar ceiling falling, or the entire ceiling can come down (see Figure 14). This is a hazard both to personnel and to equipment in the control room and

can disrupt operations during the critical period after an earthquake.

### II-2.1.6.3 Transmission And Distribution Lines

- **Transmission Lines**--Transmission lines have been very resistant to earthquake damage; their main vulnerabilities are foundation failure of transmission towers or the loss of a tower due to a landslide. Both occurrences are relatively rare. It appears that the natural frequencies of lines and towers are removed from the high-energy content of earthquakes, and the design for wind, ice and broken wire loads is adequate for earthquakes.
- **Distribution Lines**--Distribution lines are also seismically robust. Their main vulnerability in the United States is from burn-down when earthquake induced vibrations cause adjacent lines to come in contact. This is usually limited to lines in the 4 kV to 16 kV range. If they are energized, they will arc and may burn through the line causing it to fall. Burned-down lines can be a significant source of fires, and they have generated large numbers of calls by the public to the emergency response system. There are other potential causes of distribution line failure, such as collapse of adjacent structures and fallen trees, but these are beyond the control of the utility. While repair can be labor intensive, only limited numbers of customers are affected by any given downed line, and spare parts are usually not needed to effect a repair.

More severe problems are caused by inadequate anchorage of relatively small pole- and platform-mounted transformers (see Figure 15) used to step down power to service voltages. As many as 800 units fell to the ground in the 1952 Kern County, California, earthquake. There may be secondary damage or injury when they fall. Failure will cause local disruption; however, large numbers of failures can cause significant disruption. Repairs will require spares and are labor intensive.

### II-2.1.6.4 Communication (Power Utility), Monitoring, Protection, And Control Facilities And Operations

This element deals with the overall operation of a power system and the main components needed to execute these functions.

- **System Monitoring**--Components of the monitoring system are distributed throughout the system and are sometimes included in other power system elements. For example, a current transformer or capacitive-coupling voltage transformer are usually included in the transmission and distribution substation element. Their function is related to system monitoring and control.
- **System Control**--System control includes many components that are distributed throughout the system and the energy control center.
- **Communication Systems**--The disruption of utility communications has been caused by the loss of power and the lack of emergency power, inadequate anchorage of equipment and cable trays, loss of radio repeaters, and traffic overload on radio and telephone systems. There have been problems in performing a total system evaluation because of the large diversity of

## RECOMMENDATIONS FOR LIFELINE SEISMIC STANDARDS

communication media and the fact that many systems have evolved as independent subsystems. There can also be hidden interdependencies.

Communications gear has experienced some problems, primarily because of the way this equipment is installed. Communications racks often take the form used by the telephone industry; that is, they are 0.48 m wide, 0.20 m or fewer deep at the base, and relatively tall. Because of their narrow base, base anchorage is subjected to large overturning moments and prying, and the method of construction frequently yields a relatively flexible rack. The equipment in the rack can be very heavy. There have been examples of circuit cards coming out of the rack, deflections in the rack damaging cable connections, and racks falling over.

Communications are needed for power dispatching (control of power plant output), switching (to clear and isolate circuits so that they can be repaired, and to reconfigure the system to better use available power), and the dispatch of service crews.

### II-2.1.6.5 Maintenance Support Facilities

- **Service Centers**--The documentation of the earthquake response of service facilities is relatively poor. Their failure usually does not impact system performance directly and would only come into play for larger earthquakes that start to overwhelm system redundancy so that damage has caused disruption. In that case service facilities and crews are needed to repair damage. Experience does indicate that earthquakes have affected these facilities.

Service crews are usually dispatched from the service centers using a base station to communicate to mobile radios in vehicles. Radio repeaters used to dispatch repair crews have been disrupted due to damage or lost of power. The loss of communications impairs the control of repair crews.

For example, in one earthquake there was a loss of commercial power, and the lack of emergency power had severely disrupted the operation of a service center. With the loss of power, there were no lights, inventory control computers were down, the base station radio for dispatching service vehicles was down (a mobile unit in a vehicle was used, but it did not have the range of the base station), and air conditioning was down so that telephone and microwave equipment became hot. For unexplained reasons, all telephones, including the utility owned system at the service center, were out for several hours after the earthquake. In this case, damage had to be reported using the overloaded and impaired radio system. Loss of commercial power to repeaters also impaired the service crew dispatching system.

- **Spare Parts Storage Facilities**--Many spare parts are stored with no consideration of earthquakes. Some large oil-filled bushings must be stored in a near vertical position, which is achieved by leaning them against a wall without adequate restraint. Some bushings are stored by stacking them in their original shipping crates, which deteriorate and are easily damaged. The loss of spare bushings can be particularly disruptive since they are one of the more vulnerable items. Smaller parts stored on shelves have been dumped to the floor. While this has caused some damage, it also delays the availability of the inventory for use in restoration.



The failure of a computer-based, work-order system and the bypassing of the system to expedite restoration can lead to a loss of inventory control so that the number and location of spares are not known. For example, spares had been shipped and were sitting at a site where they were not needed. Their location was not discovered until some time after they were needed at another site.

## **II-2.2 Current Practice**

Buildings associated with power systems generally are subject to local building codes. This includes power plants, the structure that contains the energy control center, substation control houses, service center buildings, and buildings for the technical support staff. Within California, these codes have included seismic requirements for some time, and are constantly updated. However, older structures may be deficient. Outside California, most building codes have not had seismic requirements-- attitudes are now beginning to change. As noted earlier, building codes establish minimum criteria for life-safety. For a major earthquake, severe damage can be expected and the buildings may not be functional, which may be required for continued power system operation.

In general, most power system facilities other than buildings are not governed by seismic codes or standards. An exception is IEEE 693, "Recommended Practices for the Seismic Design of Substations," a standard that is used by the Western Area Power Administration (WAPA) but otherwise is seldom if ever used. Large power utilities have manuals of practice that cover the design and construction of power facilities; however, outside California, most utilities have few if any seismic requirements. Many utilities have formally adopted a .2g horizontal static force requirement for substation equipment, which, if it is used in procurement specification, is typically not seriously considered. The use of this requirement for equipment anchorage, particularly for critical high voltage substation equipment is very limited. The .2g static requirement provides little protection to high-voltage substation equipment even if it is rigorously applied. In the last two years utilities outside of California have given more consideration to earthquakes, but the effort has been very fragmented.

In general, California utilities have instituted practices to improve seismic performance. Seismic practices that are in more general use will be noted below. For most utilities outside California, the earthquake hazard is not a salient issue, and little has been done to improve the seismic response of their facilities.

Two recent papers review power system practices (Schiff 1991e; Yokel 1990).

### **II-2.2.1 Power-Generation Facilities**

The Uniform Building Code (UBC) is often used for the design of power-generating plants. However, outside California its seismic requirements are generally not used. Piping within the plant is governed by ASME Pressure Vessel and Piping Code. Liquid storage tanks are also governed by seismic elements in codes. There are isolated cases of stringent seismic design criteria being applied outside California, but typically these facilities are owned by California utilities.

### **II-2.2.2 Transmission And Distribution Substations**

While IEEE 693 establishes recommended practices for the seismic design of substations, it is not

## RECOMMENDATIONS FOR LIFELINE SEISMIC STANDARDS

used by California utilities, and its use by utilities other than WAPA is not known and is unlikely. Substations have control houses for operating personnel, protective relays, communications equipment, station batteries, and other important equipment. Most of these structures, particularly large substations that tend to be old, were probably built before building codes had stringent seismic elements (even in California). Many are unreinforced masonry and very vulnerable to collapse. In most of the country, seismic portions of the building codes may still not be applicable, and many facilities are located where there is little or no code enforcement. Major California utilities have developed manuals of practice that consider seismic criteria, and they have been upgraded as earthquake experiences have identified inadequacies. Over the years, the major California utilities have performed several seismic reviews of their systems and instituted some retrofits to address vulnerabilities. Recently, significant retrofitting has been initiated. Noteworthy are substation control houses, which in most regions of the country would be *grandfathered* and not be subject to review.

### **II-2.2.3 Transmission And Distribution Lines**

Wind and ice loads and broken wire conditions govern the design of these facilities. Seismic design codes or standards are not used for transmission or distribution towers or line-support structures.

### **II-2.2.4 Communication, Monitoring, Protection, And Control Facilities And Operations**

This critical power system function and related components are generally given no seismic protection. Even in California these facilities may not be given the attention they deserve. In recent years, California utilities have given special consideration to their energy control centers, and alternative energy control centers have been or are being developed. There are no seismic standards for these facilities. General communication standards within the industry are lacking, making exchange of equipment between utilities difficult.

### **II-2.2.5 Maintenance Support Facilities**

While buildings used for these functions are governed by codes, no consideration, in general, is given to providing seismic protection to spare parts, methods of storage, computer systems, or communication systems. Limitations of building codes for operability have been discussed above.

### **II-2.2.6 Technical Support Facilities**

Previous comments about the building codes also apply here. Often buildings are rented by the utility. In one earthquake, the building owners denied access to the structures until they could be thoroughly inspected to reduce their own liability exposure. As a result, engineering drawings for damaged facilities were unavailable.

### **II-2.2.7 Emergency Planning And Response**

Most utilities have emergency response plans that are used on a regular basis for the smaller emergencies that commonly befall utilities, such as wind and ice storms. Most of the plans and procedures are not suited for a major earthquake. Major California utilities do address the special issues posed by earthquakes in their emergency response plans. For example, these utilities have or are in the process of developing emergency operation centers.

### II-2.2.8 Postearthquake Evaluation

Two organizations have focused on postearthquake evaluation of power system facilities: the Earthquake Investigations Committee, Technical Council on Lifelines Earthquake Engineering (TCLEE), ASCE, and the Electric Power Research Institute (EPRI). TCLEE works with the Earthquake Engineering Research Institute (EERI) and the National Research Council, National Academy of Sciences, in conducting postearthquake investigations. If these organizations do not investigate for some reason, TCLEE may institute its own investigation. Results of these investigations are usually published by EERI in Reconnaissance Reports. EERI earthquake investigation activities are supported through a National Science Foundation grant, and TCLEE has limited funds available through ASCE. Investigators work on a pro bono basis with expenses sometimes partially covered by EERI and/or TCLEE. TCLEE has just published a detailed manual for conducting postearthquake investigations for all lifelines including power systems (Schiff 1991c).

EPRI also investigates power system facilities and industrial facilities after damaging earthquakes. While the focus of their investigations is on equipment found in nuclear generating plants, they also look at damage to other power facilities. Some of their results may also be published in EERI Reconnaissance Reports and in EPRI reports. Access to EPRI reports is restricted to EPRI member utilities. Detailed damage and success data are often collected in their investigation. Their investigators are usually under contract to EPRI.

It should be noted that for more damaging earthquakes, the affected utility usually does not have the personnel to do a timely postearthquake investigation because personnel are needed to restore service. California utilities are in the process of developing joint investigation teams so that experienced outside resources can be quickly brought in to perform an investigation.

There is a growing problem of gaining access to facilities to perform a postearthquake investigation. This involves two liability issues. First, is the concern for the investigators since there is often much activity involving heavy construction equipment at a damaged substation. Second, is the concern that litigation will result from disruption of service, and disclosure may increase a utility's liability exposure.

Under the provisions of Public Law 101-614, the U.S. Geological Survey (USGS) has been given primary responsibility for coordinating postearthquake investigation activities. The National Science Foundation (NSF), Federal Emergency Management Agency (FEMA), and National Institute of Standards and Technology (NIST) are given supporting roles. A report that identifies the role each organization plays relative to postearthquake investigations is being prepared (Schiff 1991d). Two other organizations have also been identified to participate in this process. The Agency for International Development (A.I.D.) will be involved in foreign earthquakes and the Centers for Disease Control (CDC) in medical issues.

### II-2.3 Existing Knowledge

TCLEE has conducted a series of specialty conferences and symposia addressing seismic issues related to power systems. Proceedings have been published.

Also, TCLEE has published *Advisory Notes on Lifeline Earthquake Engineering*. This material is descriptive in character and not in a standard or code format. These notes review earthquake damage and give some general guidance for improving seismic response of power systems.

## RECOMMENDATIONS FOR LIFELINE SEISMIC STANDARDS

Detailed suggestions are given for the anchorage of a few types of equipment. In addition, TCLEE has published *Annotated Bibliography on Lifeline Earthquake Engineering* (ASCE 1980), which lists reports that deal with power system seismic damage, analysis, and design. The vast literature dealing with nuclear power plants was not included.

A series of earthquake reconnaissance reports documents power system damage. While these reports clearly show that power systems are very vulnerable to earthquake damage, most do not contain details on the type of equipment that was damaged, failure modes, or factors that may have contributed to the failures. An EPRI study that is in progress is reviewing past California earthquakes to evaluate the above types of information.

There is a vast literature on seismic design and analysis procedures associated with nuclear generating plant equipment and facilities. Little of this material is relevant to non-nuclear facilities, although this effort significantly improved methods of analysis and identified many basic seismic issues.

The Electric Power and Communications Committee, TCLEE, ASCE, is developing a seismic design guide for power systems.

EPRI is developing a manual of good seismic practices for substations.

### II-3. STANDARDS DEVELOPMENT

#### II-3.1 Introduction

This section discusses issues associated with each of the six parts of power systems. Each part of the standard will contain a brief statement of scope, identify activities involved for its development, suggest priorities and a schedule for activities, estimate the cost of development, and identify research needs and associated research schedules and cost estimates. Possible organizations to develop prestandards and/or develop standards will be identified.

Three types of activities are envisioned in the development of standards. The first type of activity is fundamental research that may be needed to gain a better understanding of a topic or to develop tools needed for the application of a standard. A second activity is the development of prestandards or draft standards. This would be carried out by specialists who have the expertise to address seismic issues, to expedite the development of standards, and to overcome the resistance to initiate standards activities. Finally, standards are developed by an appropriate standards organization in which the process of developing a consensus standard is executed.

#### II-3.2 Features And Issues Related To Electrical Power Systems

Before proposing power system standards it may be useful to discuss a few characteristics of power systems that distinguish them from other lifelines and other issues that affect standards.

- The *commodity*, which power systems generate and distribute, electric energy, is used as it is generated. In general, there are no locations where energy is stored, as is true with water and fuel systems. As a result, if there is a disruption in the supply of commercial power, equipment, systems, and facilities that require power immediately stop. Critical functions may be supplied with emergency back-up power; however, these typically have very limited capacity so that most operations are severely disrupted.

- There is little control over the flow of power within the network once it has been generated. Also, if a line becomes significantly overloaded, the overloaded line must be opened. Electric power generated at a power plant will travel through the lines connecting the generator to the user, typically over multiple paths. The current flowing over any path is determined by the impedance of the path. Thus, there is no method of significantly modifying the flows for a given system configuration other than changing the physical distribution of load (dropping load) or of power sources (modifying output of generating units). The capacity of a path is not necessarily related to its impedance, so that unbalanced flows may occur, particularly if the system is configured in an unusual way, as might happen after an earthquake. If the current along any path exceeds the capacity of any component within the path, protective monitoring devices will cause a circuit breaker to open. This will stop all power flow in the path and alternative paths must carry the power formerly carried on the opened circuit. Three things can be done to balance power generation and consumption and to control the flow of current through the system: (1) the power output of generating stations distributed throughout the system can be adjusted (the usual procedure under normal conditions), (2) the configuration of the transmission network can be changed (under severe conditions the grid character of the transmission network can be changed to a tree-type network), and (3) in extreme cases load can be dropped.

The inability to store electrical energy in the system and the immediate reallocation of the flow of energy within the system when changes are made in the system configuration require a sophisticated and sensitive control system to provide reliable service in the face of numerous problems that commonly befall power systems.

- Power systems are the lifeline to most other lifelines and emergency response facilities. The operation of most other lifelines can be significantly disrupted if they lose commercial power. The operations of many critical facilities, such as hospitals, are significantly impaired if commercial power is disrupted and they must function using their emergency backup power for more than a short interval.
- Damage associated with earthquakes is markedly different from most other power system emergencies. Power utilities encounter minor emergencies on a daily basis and can have significant system emergencies on an annual basis, usually associated with severe weather, such as wind or ice storms. Most emergencies impact transmission or distribution lines, and utilities have developed system designs, spare parts policies, and methods of resource management to adequately cope with these contingencies. Earthquakes primarily damage or destroy high-voltage substation equipment. The repair or replacement of substation equipment takes a long time, and the availability of replacement equipment and spare parts for high-voltage substation equipment is very limited.
- As noted earlier, the greatest seismic vulnerability of power systems is their high-voltage substation equipment. The general approach to ensure that purchased equipment meet seismic requirements is to add seismic specifications when ordering equipment. However, the use of stringent seismic procurement specification is no assurance that equipment that meets the specification can be obtained. Suppliers may refuse to bid on the specifications or they may not be

## RECOMMENDATIONS FOR LIFELINE SEISMIC STANDARDS

able to design equipment that satisfies the requirements. Some suppliers of this equipment have recently been more cooperative in attempting to meet seismic specifications; however, specifications may not be satisfied. This creates a situation beyond the control of the utility.

- There are philosophical differences between standards and codes applied to buildings and those that would be applied to lifelines. Building codes and standards primarily address life-safety issues. Current building codes establish minimum standards for life-safety so that in a major earthquake collapse is prevented, while significant structural damage may occur. While building codes may have an importance factor that will tend to improve seismic performance, there is no indication for any given structure that the increased design load will ensure continued operation. In general, for most power system facilities, the potential direct impacts of power systems damage on life-safety is relatively small. The issue is operability. A severely damaged structure would have to be evacuated, which for power system facilities may disrupt power system operations.
- The ability to determine element seismic design standards based on system performance standards for redundant systems is questionable at this time. For redundant systems such as power systems, system performance criteria cannot be used directly for determining facility seismic criteria. Traditionally, building and equipment standards set design criteria based on desired performance that are keyed to seismic environment for specific facilities and equipment in a given setting. Previous small to moderate earthquakes have demonstrated that a power system can suffer significant damage and continue to operate without disruption of service. While a rational design philosophy could set criteria that would allow damage to redundant systems, the current state-of-the-art for the design of power system equipment, for the analysis of seismic response of power systems, and the great uncertainty in predicting seismic exposure raises questions on how to translate meaningfully system standards to element standards. As noted above, any approach should incorporate the objective of serviceability rather than life-safety.
- The vast majority of power system damage has been associated with the catastrophic failure of porcelain members, primarily bushings and post insulators. The traditional method of using unrealistically low design loads and providing structures with ductility is not applicable to power system equipment with porcelain members. With the exception of porcelain members and problems with leaking seals, power system equipment and facilities have performed well.
- In general, basic design loads for a given facility tend to be uniform. While design loads for a given item of equipment may vary due to structural amplification at the equipment location, the load is derived from the site seismic exposure. Consistency of design loads has its appeal. However, the large uncertainty associated with the magnitude of seismic loads, the fact that lifeline criteria are based on serviceability (not avoidance of collapse), and that power equipment is subject to catastrophic failures, suggest that design loads should be influenced by incremental cost associated with changes in the load. If such a procedure is used, different basic design loads would be used at a single facility.

## *ELECTRICAL POWER LIFELINES*

- Experience has shown that the use of analysis methods for the seismic qualification of certain types of equipment is unreliable and that vibration testing is needed to ensure acceptable seismic performance. Experience with earthquake damage provides guidance as to what equipment should be qualified by testing.
- Several factors determine the appropriate approach to seismic upgrading of existing facilities. For most regions of the country that would be significantly affected by an earthquake, the probability of a great or large earthquake in the next thirty years is relatively small. Moderate earthquakes in California have demonstrated that power systems can cope with events of this size, although system performance outside California may not be as good. Most power system earthquake damage due to moderate earthquakes can be attributed to inadequate equipment anchorage, inadequate slack in bus connections at substations, the failure of porcelain members of high-voltage equipment, and the failure of gas and oil seals. Many anchorage deficiencies can be remedied by low-cost measures. Substation equipment vulnerability primarily requires that it be replaced. Finally, the useful service life of most vulnerable high-voltage equipment is about 30 years. These factors suggest that upgrading activities should focus on improving equipment anchorage. Equipment upgrading should be achieved primarily through normal attrition where standards for new construction apply to replacements. Critical components that might affect a significant part of the system may require upgrading. In some situations, selective upgrading to provide basic power needs by seismic hardening a power path might be considered.
- A seismic element in disaster response plans should be added quickly for the following reasons: there is great uncertainty of future ground motions, a great earthquake has a potentially large impact on power systems, the seismic protection of spares is poor, and an alternative energy control center is not provided.
- There is significant uncertainty in the seismic ruggedness of power equipment. Experience has shown that seemingly minor changes in the installation of identical equipment can cause significant changes in its seismic performance. Also, large power equipment is typically special ordered, so that equipment that would generally be considered similar because of its type, manufacturer, and function can have different seismic responses.
- Equipment service lives range from 25 to 50 years. The more seismically vulnerable equipment tends to fall in the lower range of this interval.
- Electric utilities are generally considered to be monopolies. Thus, standards that increase facility cost translate into increases in utility rates and do not have a negative impact on the utility. This would allow high net earnings. In practice, this is not the case, as large customers can contract favorable rates from outside suppliers and have the utility deliver the power. Thus, many power utilities are in a rate-competitive market.

### **II-3.3 Overview Of The Basis And Approach To Power System Standards**

This section will review measures that can be used to evaluate system performance, review the implications of past seismic performance on the structure of standards, and establish an approach to seismic standards.

## RECOMMENDATIONS FOR LIFELINE SEISMIC STANDARDS

### II-3.3.1 Measures For Evaluating Power System Performance

Important to establishing standards for power systems is the determination of appropriate measures for system performance. Three measures of performance are related to life-safety, financial losses, and environmental impacts.

#### II-3.3.1.1 Life-Safety

Life-safety exposure due directly to power system damage is very small, particularly if the contribution from buildings is eliminated. Buildings are not considered since they are governed by building codes. While switchyard damage has been extensive, and the failure of bushings and other porcelain members can be explosive with the generation of porcelain fragments acting as shrapnel, these facilities are usually deserted.

The disruption of power to other lifelines and emergency response facilities is more significant to life-safety. The impact of the loss of power on life-safety under most situations would be greatest in the early stages of the emergency response period and diminish after a few days. The significance of disruption also increases with the severity of the earthquake since damage and emergency response resources play a more significant role in rescue and treatment. Thus, from a life-safety perspective, after major earthquakes emergency response facilities should have adequate power within hours after the event. This implies very low levels of power system damage to the bulk power system and to the distribution system. The cost implications to utilities of using this as a measure for power system response would be exceedingly high and still may not be achievable. The implication is that critical facilities should plan on providing adequate emergency power to satisfy societal mission.

#### II-3.3.1.2 Financial Losses

The direct losses to power systems from moderate earthquakes appear to be very small when compared to other losses in the community, but are significant relative to power system assets. In the Loma Prieta earthquake, for example, direct power system losses were about \$25 million while total direct losses were over \$6 billion.

Indirect losses from extended power system disruption can be significant. After a damaging earthquake, even if no lifeline is damaged, there will be several days in which economic activities are severely disrupted. For example, after the Loma Prieta earthquake, most commerce and industry were disrupted because of the unavailability of personnel. Workers were busy taking care of family matters for a few days after the earthquake. Disruption from damage to industrial facilities was surprisingly small. Clearly this was not the case in older, commercial districts, such as Santa Cruz, that include unreinforced masonry structures that experienced long-term disruption due to structural damage. A loss of power would stop most commercial and industrial activities. Thus, power disruption lasting more than a few days would quickly generate losses that would dwarf direct power system losses. For a major earthquake, the impact on financial losses of power disruption starts to be felt after three or four days and then becomes very strong.

These observations are based on the assumption that there is a total loss of commercial power in the impacted area. A relatively small amount of power, if it could be directed to emergency response facilities, would meet their needs. If power consumption could be limited to important functions, economic activities could operate at a fraction of normal power demand.



### **II-3.3.1.3 Environmental Impacts**

In general, the direct environmental impact of power system damage is small, particularly if it is assumed that standards for liquid fuels prevent failure of power plant, fuel-oil storage tanks. Secondary impacts due to power disruption may be larger from the loss of water (loss of pump power) or dumping of raw sewage (loss of power at sewage treatment facilities). However, these impacts, when compared to other direct effects of the earthquake, may not be significant. Thus, power system damage only becomes significant if it causes power disruption, and then it is the secondary impacts that may be significant. The two major impacts of power disruption are secondary life-safety issues and financial losses. To address the life-safety issues, disruptions of longer than a few hours to critical facilities would be significant, and is probably beyond what can be expected of power networks. The most significant financial losses are associated with disruptions that last longer than three to four days, but then mount rapidly.

### **II-3.3.2 Observations On The Seismic Performance Of California Power Systems**

Several recent small and moderate earthquakes have damaged power system facilities (see Section II-2.1.2, "Basis for Evaluating Power System Vulnerability"), but there has been very little power disruption. Small and moderate earthquakes tend to cause localized damage so that power system damage is limited to one or two substations. The limited disruption in the face of system damage is the result of the redundancy incorporated into power system design to enhance system reliability. Thus, if power systems were to have seismic ruggedness comparable to that of major California systems, little or no power disruption would be expected from small and moderate earthquakes.

Two caveats to the above statement should be noted. First, any system component that would have a major impact on the system would have to be given special consideration. For example, some California utilities did not have seismically hardened or alternate energy control centers for part of the last 20 years. Fortunately, an energy control center has not been damaged by an intense local event, for its severe damage could cause system-wide problems.

Second, the lower seismic attenuation in most areas outside California may cause several substations to be damaged by a moderate earthquake, thus overwhelming system redundancy and causing significant disruptions.

The pattern of damage from small and moderate California earthquakes suggests that large and great earthquakes may damage sufficient numbers of substations that system redundancy could be overwhelmed and extensive, extended power disruption may result.

### **II-3.3.3 An Approach To Seismic Standards**

In the following approach to seismic standards three key issues are to be addressed. The approach parallels methods used by some California utilities to address seismic issues. It is noteworthy that these utilities adopted this approach based on prudent business practices rather than regulation mandates.

First, power systems should use good seismic design and installation practices, since they have proved to be a cost-effective method of increasing seismic ruggedness of power systems. While these practices have been used by California utilities, they have to be clearly defined so that they can be evaluated. If this is done, little or no disruption could be expected from small and

## RECOMMENDATIONS FOR LIFELINE SEISMIC STANDARDS

moderate earthquakes. There would still be a potential, however, for extensive, extended power disruptions from large and great earthquakes.

Second, for large and great earthquakes, systems should be designed so that seismically hardened power paths are provided in the power network so that important economic functions can continue. While there may be damage to the distribution system, this should only cause local disruptions that can be addressed using normal emergency response procedures. The power needed to maintain important economic functions is referred to as *basic power needs* and will have to be better defined. For example, basic power needs would not include residential or commercial air conditioning.

Third, a substantial period to phase in standards will be used for the following reasons. The return period for large and great earthquakes varies between different parts of the country and is quite long. The costs associated with modifying a power system to meet the above two criteria in a short time interval would be very large. In the implementation interval a large or great earthquake could cause significant power system damage and disruption. In this window of elevated risk, it is important that measures that enhance postearthquake response and recovery are quickly put in place.

It should be noted that the suggested approach is not highly dependent on seismic retrofitting systems, but rather through seismic upgrading of facilities in the normal course of system evolution. There will be some situations where retrofitting facilities would be prudent or required. California experience shows that the use of good seismic practices does not significantly add to costs and that providing for seismic hardened power paths need not be excessively expensive. Also, for new construction, or replacing equipment under normal refurbishment, the use of seismically rugged equipment for vulnerable items (some high-voltage substation equipment) does not significantly increase cost.

The above approach is at variance with cost-benefit analysis based to total seismic risk, which has not been adopted here for several reasons. Some of these are noted in Section II-3.2. Even the use of scenario-based approaches as a basis for national standards is questionable at this time because of the experience and judgment needed for proper implementation. **As noted in Section II-2.1.4**, these methods are currently used by California utilities and they provide useful information for improving seismic performance of power systems. However, the experience base for their use is limited to California. There is a need for the development of these tools so that they can be more widely used and eventually form the basis of power system standards.

### II-3.3.4 New Construction, Refurbishment, And Retrofitting

Three types of construction are envisioned. First, for new construction, for example, a new 500 kV substation, good seismic design and installation practices should be used. Equipment should meet specifications for new equipment, and the facility should be evaluated for seismically hardened power paths to meet basic power needs of the system. Second, for construction and replacement of facilities during normal system refurbishment, replacement equipment should meet seismic specifications for new equipment, and good seismic design and installation practices should be used. In refurbishing certain facilities, it may not be cost-effective to meet all seismic standards for new construction. In this case, good seismic design and installation practices will be used in a prudent way. Finally, modifications made primarily to improve seismic performance are referred to as seismic retrofitting. Seismic retrofitting is done to meet standards and at the discretion of the utility to enhance the seismic ruggedness of its facilities to satisfy corporate

policies.

Seismic retrofitting would come about at the mandate of standards in the following way. The system performance evaluation standard uses element evaluation standards to determine if system performance meets the policy statement. The element evaluation standards establish milestones for gauging the progress of the system in arriving at the policy statement. If in the normal course of seismically upgrading facilities during system refurbishment and expansion, element milestones are not met, seismic retrofitting would be needed.

### II-3.4 Structure Of Power System Standards

Lifeline earthquake standards for power systems should be developed in each of the five categories listed below.

- **Policy Statement Standard**--A document that defines desired levels of system performance in terms of degree and duration of power disruption of the transmission system for different size events or seismic exposure. In addition, an implementation schedule for different parts of the standard would be keyed to seismic risk. This schedule would specify completion times for different parts of the standard. The standard would also contain criteria for evaluating disaster response planning and provisions for postearthquake investigations. A completion time for the implementation plan schedule for these parts would be specified.
- **System Performance Evaluation Standard**--A document that defines procedures for evaluating seismic performance of a power system so that it can be determined if the system satisfies the policy statement standard. The standards would evaluate the ability of a power system to meet system performance criteria and the status of its implementation schedule. This standard would use the results of the evaluation of each of the six physical system elements, and an evaluation of disaster planning and response, to evaluate system performance. (See Section II-1.1 for a definition of power system elements.) In addition, milestones in the implementation plan would be identified and the status of the implementation plan would be evaluated in terms of achieving milestones.
- **Element Evaluation And Design Standards**--These standards should address two issues: evaluation of existing elements and standards for new or replacement components that make up the element. Standards associated with each issue would have seven parts or would be seven separate standards, one for each of the six physical elements plus disaster planning and response, that comprise power systems. (See Section II-1.1 for a definition of power system elements.) Each part or standard defines procedures for evaluating seismic performance of existing power system elements. The results of this evaluation must be compatible with procedures of the System Performance Evaluation Standard. The standards should be developed in such a way that if the seismic status of an element does not meet performance standards, there are indications as to deficiencies in the element that must be rectified.
- **Equipment And Material Standards**--Standards that establish seismic design criteria for new equipment or materials. These standards would address components that make up power system elements.

## RECOMMENDATIONS FOR LIFELINE SEISMIC STANDARDS

- **System Disaster Response Planning Standards**--Standards that define minimum criteria for enhancing seismic emergency response.

### II-3.5 Standards Development Activities

Activities needed for the development of each of the five categories of power system standards are identified. For each there will be a brief statement of scope, a discussion of issues related to that category, and a list of tasks needed to develop the standard. Each task will be described, effort and cost needed to complete the task will be estimated, and a priority for the task assigned. Section II-3.7 will indicate the relationship between tasks and develop an overall schedule for activities.

It should be noted that three factors have been used in arriving at the priority of a task. One is the importance of the task, that is, how this task will effect power system disruption. For example, a task dealing with improving the seismic response of transmission lines would not be very important since transmission lines at present perform well in earthquakes. A second factor affecting priority is the level of effort and time it will take for the results of the task to have an impact on system performance. For example, an important item, which because of needed research and prestandards activities will take much longer before it can be implemented, will be given a lower priority than an equally important item that can be implemented quickly.

Some tasks will have to be phased into an implementation schedule later than others and this should be taken into account in allocating resources to implement the plan; however, issues of scheduling will not be taken into account in establishing priorities. Thus, priority and scheduling should be considered in the allocation of resources for implementing the standards plan.

As noted in Section II-3.1, three types of standard development activities are envisioned. The basis for estimating the time and cost for each of these activities is as follows. Research activities would be done by consultants from the power industry, universities, or consulting engineering firms. The number of individuals who might be involved and the person-years effort and the duration of the effort will be estimated. A figure of \$100,000 per person-year is used to arrive at cost estimates for large, long-term projects.

Prestandard activities will probably be carried out as task groups with individuals drawn from the ranks of technical committees of professional societies. Because of the desire to expedite this effort, the level of these activities would require support. It is assumed that individuals would be compensated at a rate of \$1,000 per day. This figure would include benefits and overhead. In addition, travel expenses would be reimbursed. The number of meetings and their duration and the effort required between meetings will be estimated as well as the duration of the entire process. All cost estimates will be rounded up to the nearest \$10,000.

The development of consensus standards would be carried out by the appropriate standards groups, such as ASCE, IEEE, etc. The level of effort for this activity is a function of the complexity of the standard, the thoroughness and form of the prestandard documents, and controversies that may arise in arriving at the consensus document. Based on information provided by the ASCE Standards Group, most members of standards committees are volunteers and are not supported. A control group of five members is provided with travel support.

Depending on the number of issues that must be addressed, meetings typically last two days so that each meeting requires about \$5,000 support. For a simple, uncontroversial standard that is

## *ELECTRICAL POWER LIFELINES*

well prepared two meetings may be required. More complex or controversial standards may require ten or more meetings. In addition, some members who worked on the prestandards activity would continue to work with the standards group to provide continuity and to serve as a resource to explain the prestandard document. It is assumed that they will be working at the same rate indicated above. For budget purposes, three individuals are assumed to continue to work on the standards activity, and they will spend two days preparing for each meeting. Three people for six meetings for four days' effort per meeting at \$1,000/ day equals \$72,000. Staff time for the standard organization may vary between standards organizations, but an estimate for ASCE is \$15,000 per active standard committee per year (Schiff 1991b). Because it is difficult to estimate the complexity and how controversial a given standard will be, it will be assumed that on average, six meetings will be required and the administration of each standards committee will be \$15,000 per year. Because of the formal process that must be followed in establishing consensus standards, it is a long process. It takes from two to six months to authorize a new standards activity and an additional two to three months to form a consensus group. These activities can be done before the completion of the prestandards activities. It will be assumed that there will be a committee meeting every three months over an 18-month interval. Because of the time to get letter and public ballots, these activities are assumed to take a total of two years on the average. The estimated average total cost for consensus standards development is \$140,000.

For many power system components there is no associated existing standard organization. In some cases there may be an organization with a natural affiliation, but it may not have the background, interest, or expertise to deal with seismic issues. In these and other situations, it may be desirable to establish a contract with an appropriate organization or individual to develop or manage the development of prestandards to facilitate consensus standard development.

The five categories of power system standards are hierarchical in character, later parts being influenced by those that came first. Various questions are associated with each of the categories; however, to simplify the development of the standards, activities associated with a given power system component have been grouped together in a single task. Roman numerals between I and V are used to identify tasks grouped under each of the five categories of standards.

Three types of tasks are associated with the development of each standard. There are tasks needed to identify technical issues and formulate a prestandard document that would be the basis for the standard. These tasks are grouped together and designated as prestandard activities and are identified by a "P." The formal procedures for establishing a consensus standard by an established standard organization, such as ASCE or IEEE, are referred to as standards development activities and are identified by a "D." Additional tasks that would provide information that would significantly enhance the quality of standards but are not necessary for standard development are designated as research tasks and are identified by a "R." Chart 1 shows each standard and tasks associated with its development. Tasks associated with different categories of the standard are also related. Chart 2 indicates relationships between the tasks and the standard categories.

All standard and prestandard tasks are given equal priority, since the standards form an integrated package. The schedule of tasks reflects the fact that information developed for certain tasks is needed for other activities. Table 1 lists all tasks, the priority of each, and a rough schedule. It should be noted that limitations of resources may delay the initiation of some tasks. The appropriate sequencing of tasks can be inferred by Chart 2. Information needed from various tasks is also indicated in the statement for the development of standards.

A stand-alone standard for emergency power systems will be developed. This will simplify its

## RECOMMENDATIONS FOR LIFELINE SEISMIC STANDARDS

use by other lifelines and critical facilities, such as hospitals and emergency response facilities.

### II-3.5.1 Policy Statement

A document that defines desired levels of system performance in terms of degree and duration of power disruption of the transmission system for different size events or seismic exposure. In addition, an implementation schedule for different parts of the standard would be keyed to seismic risk. This schedule would specify completion times for different parts of the standard. The standard would also contain criteria for evaluating disaster response planning and provisions for postearthquake investigations. A completion time for the implementation schedule for these parts would be specified.

The policy statement must address three topics.

- **Good Seismic Practices**--Determine the extent that good seismic practices (conforming to *California* practice) are used in the design, construction, and installation of power elements (see Task III-1(P)). The time interval for compliance with this part of the standard must be determined as described below (see Task I-1(P)).

Because of the close relationship between this part of the policy statement and the technical issues associated with evaluating the use of good seismic practices in each power system element, this part of the policy standard is to be developed in Section II-3.5.3 Task III-1(P). In addition to good seismic practices, special consideration will have to be given to system components that can affect the entire system. An example of such a component would be the energy control center. The special needs to address this standard will be described in Task I-1(P).

- **Seismically Hardened Power Paths**--Determine the degree that seismically hardened power paths can provide basic power needs (Task III-1(P)). The method for determining the time interval for compliance with this part of the standard is developed in Task I-1(P).

Because of the close relationship between this part of the policy statement and the technical issues associated with evaluating seismically hardened power paths, this part of the policy standards is to be developed in Section II-3.5.3, Task III-1(P). The method of determining basic power needs is described below in Task I-2(R).

- **Disaster Response Planning**--Determine the degree to which disaster response planning and mitigation are satisfied. This requires the evaluation of certain facilities and actual plans. The time interval for compliance of this part of the standard must be determined as described below in Task I-1(P).

Because of the close relationship between this part of the policy statement and the technical issues associated with evaluating disaster response facilities and disaster response planning, this part of the policy statement is to be developed in Section II-3.5.5, Task V-1(P).

There is a need for a manageable, credible methodology for evaluating power system response to earthquakes. Research directed at modeling methods is described in Task I-3(R).

**Task I-1(P)--Identify Prestandard Tasks For Policy Statement Standard**

**A. Evaluate Critical Components That Could Have A Significant Impact On System Response**

Power systems would be reviewed to identify critical system components that could have a significant impact on a large portion of a system. Examples of such components might be the energy control center, a utility's major communication center, or a control house at a critical substation. The product of this effort would be a prestandard that identifies remedial actions and a timetable for their implementation. Since the malfunction of these key components could cause major disruption from small or moderate earthquakes, they should be implemented on a fast track in the process of getting the system to conform to good seismic practices. This task is related to Task V-1(P).

**Participants:** Electric Power and Communications Committee, TCLEE (supplemented with individuals familiar with system operations), or other group familiar with earthquake effects on power systems, and system operations.

**Duration:** 1 year

**Cost:** \$110,000  
(Basis of cost estimate: six-person working group, has four two-day meetings over the interval with two days' preparation per meeting. Travel cost--\$10,000 assuming committee members would be from California. For this level of activity, participants would have to be compensated for meetings and work assignments between meetings--\$100,000.)

**B. Determine Risk-Based Implementation Times**

The time intervals to complete tasks associated with achieving good seismic practices, seismically hardened power paths, and disaster response planning should be determined. This should take into account the probability of the seismic hazards in the region, and the expected service life of the impacted power facilities. For example, as envisioned by the author, in the New Madrid area the phase-in process would be scheduled for completion in about 30 years. Some parts of the process may go faster, as indicated below. In regions with long return periods for large and great earthquakes, timing may be driven by the operating life of the facilities rather than by the probability of large seismic events.

A key issue is that until good seismic practices and seismically hardened power paths are in place, there is a relatively large vulnerability of an extensive, extended power disruption. For this reason, it is important that disaster-planning efforts, which should be of relatively low cost, should be implemented quickly, within several years.

**Participants:** Experts in regional seismic risk in operating lives of power facilities, and in industrial power demand.

**Duration:** 1 year

**Cost:** \$110,000  
(Basis of cost estimate: six-person working group, has four two-day meetings over the interval. Travel cost--\$10,000. For this level of activity participants

## RECOMMENDATIONS FOR LIFELINE SEISMIC STANDARDS

would have to be compensated for meetings and work assignments between meetings--\$100,000.)

### **Task I-2(R)--Conduct Research To Determine Basic Power Needs For Various Communities**

There is a need to develop a simple, approximate method for determining basic power needs, that is, power demands on a utility. This will vary with the customer base of the utility. It is suggested that census data be used to estimate these needs. An EPRI document (EPRI 1988) provides information on power consumption by two-digit Standard Industrial Classification (SIC) in the period around 1987. The use of this data in conjunction with census data should provide a useful estimate of basic power needs for any utility. It would even be possible to determine the distribution of needs throughout the system (if this was justified) rather than having to use an average demand for the entire system. Questions of reduction of demand due to industry damage may also be considered. Some other approach to estimating basic power needs may be more appropriate. It is anticipated that once the power system meets seismic standards there would be significant power disruptions for only large or great earthquakes, in which case, methods of limiting power may be needed. Policies and procedures should have to be developed for controlling the use of limited power in the postearthquake environment. Public service announcements directed at residential and industrial users, brownouts, rolling blackouts, or other methods should be explored. It would be advantageous to have limitation procedures sanctioned by a Public Utility Commission (PUC) or other authority, rather than using ad hoc methods in an emergency.

The results of this effort will be a methodology to be used by a utility to determine the basic power needs it will have to supply.

**Participants:** Experts on industrial power demand, census data, and people familiar with impact of earthquakes on industrial facilities.

**Duration:** 1 year

**Cost:** \$80,000  
(Basis of cost estimate: four-person working group, has four two-day meetings with two days' preparation per meeting over the interval. Travel cost--\$10,000. For this level of activity participants would have to be compensated for meetings and work assignments between meetings--\$70,000.)

### **Task I-3(R)--Conduct Research On Modeling Earthquake Response Of Power Systems**

There is a need for cost-effective methods for getting realistic evaluations of power system performance in earthquakes. These methods must take into account actual system configurations and performance of specific equipment (at least for the most vulnerable equipment items). System redundancy, both in the network and within the substation should be reflected in the methodology. The development of these methods are needed for the long-term improvement in the evaluation of system performance and enhancement of seismic specifications of facilities and equipment. It is vital that the methods be evaluated using several real power systems. The final product should be user friendly and transportable so that the methodology can be exercised by utilities after a reasonable training period.



**Developers:** Consortium of utilities, EPRI, consultants, and academic researchers.

**Duration:** 2 years

**Cost:** \$550,000  
(Basis of estimate is that this will be a four-person/year effort. About \$400,000 for development and \$150,000 to run tests on three utilities.)

#### **Task I-4(D)--Develop Policy Statement Standard**

The results of Tasks I-1(P), III-1(P), IV-1(P), and V-1(P) should provide a basis for formulating a policy statement standard. This standard should specify how information determined in evaluating system elements is used to determine if the policy statement is satisfied. A completion time for the implementation plan schedule for standard parts should be specified, taking into account the hazard exposure.

**Developers:** It is not clear what organization would take responsibility for developing a consensus standard. IEEE or ASCE would be candidates.

**Duration:** 2 years (See Section II-3.5)

**Cost:** \$140,000 (See Section II-3.5)

#### **II-3.5.2 System Performance Evaluation Standards**

A document that defines procedures for evaluating seismic performance of a power system so that it can be determined if the system satisfies the policy statement standard. The standards would evaluate the ability of a power system to meet system performance criteria and the status of its implementation plan schedule. This standard would utilize the results of the evaluation of each of the six physical system elements, and an evaluation of disaster planning and response, to evaluate system performance. In addition, milestones in the implementation plan would be identified and the status of the implementation plan would be evaluated in terms of the achievement of milestones.

Six physical elements plus disaster planning and response have been identified as making up power systems operations. The seismic performance of these seven elements will determine the degree to which a power system satisfies the policy statement standard. Using the concept of the policy statement standard proposed above, two characteristics of power system elements will have to be determined, as follows:

- Are the seismic ruggedness characteristics of power system elements comparable to those used by major California utilities (as defined in Task III-1(P))? An overview of the seismic ruggedness of each element is given in Section II-3.5.3.
- Do those parts of critical elements that control the seismic reliability of critical power meet the seismic specifications for these elements?

Methods for evaluating basic seismic requirements of existing facilities and for evaluating the reliability of critical components are closely related to the methods for evaluating these components. Therefore the methods for using the results of element evaluation for system evaluation will be incorporated into the following

## RECOMMENDATIONS FOR LIFELINE SEISMIC STANDARDS

sections. This effort will also be related to equipment specifications discussed below.

### **Task II-1(D)--Develop System Evaluation Standards**

Using the results from the research described below, develop system evaluation standards.

**Developers:** It is not clear what organization would take responsibility for developing a consensus standard. IEEE or ASCE would be candidates.

**Duration:** 1 year (See Section II-3.5)

**Cost:** \$140,000 (See Section II-3.5)

### **II-3.5.3 Element Evaluation And Design Standards**

Standards would address two issues, evaluation of existing elements and standards for new or replacement parts of elements. Standards associated with each issue would have seven parts or would be seven separate standards, one for each of the six physical elements plus disaster planning and response that comprise power systems. (See Section II-1.1 for a definition of power system elements.) Each part of the standard or each standard defines procedures for evaluating seismic performance of existing power system elements. The results of this evaluation must be compatible with procedures of the System Performance Evaluation Standard. The standards should be developed in such a way that if the seismic status of an element does not meet performance standards, there are indications as to the deficiencies in the element that must be rectified.

Each power system element is reviewed below and research and prestandards requirements for the element are identified. Roman numbers identify the research or prestandard tasks associated with the element.

- **Power-Generating Facilities--**Seismic performance of these facilities has been good, and evaluation is limited to determining if there is a large percentage of generating capacity concentrated in a small area. Supplemental seismic standards for generating facilities and methods for evaluating if there is a concentration of generating sources are developed in Task IV-1(P),E.
- **Transmission And Distribution Substations--**This element contains the most seismically vulnerable components, and evaluation procedures must be developed. These methods are developed in Task III-1(P). Research and prestandard tasks associated with design standards are developed in Task IV-1(P),A.
- **Transmission And Distribution Lines--**The seismic performance of transmission and distribution lines has been good, and no evaluation of this element is needed. Supplementary standards for distribution equipment are developed in Task IV-1(P),E.
- **Communication (Power Utility), Monitoring, Protection, and Control Facilities and Operations--**Performance of some components of this element have been poor. Evaluation procedures and design standards are

needed and are developed in Tasks III-1(P), E and V-1(P).

- **Maintenance Support Facilities**--Seismic design for some components in this element are poor. Evaluation procedures and design standards are needed and are developed in Task IV-1(P), D.
- **Technical Support Facilities**--Seismic vulnerability of some components in the element is high. Evaluation procedures and design standards are needed and are developed in Task IV-1(P), E.
- **Disaster Response Planning**--The adequacy for earthquakes of some components of this element are poor. Evaluation procedures and design standards are needed and are developed in Tasks V-1(P) and V-2(D).

Research strategies for defining good seismic practices are developed in Task III-1(P),A. In addition to the tasks referred to above, there is a need to do an overall system evaluation to identify system elements that can affect a significant part of the system. Task III-1(P) addresses this need.

### **Task III-1(P) Develop Prestandard Element Evaluation And Design Standards**

#### **A. Define Basic Seismic Requirements**

The meaning of the expression *good seismic practices* is not well defined. While major California utilities currently have stringent seismic qualification specifications for substation equipment and testing requirements for some classes of equipment, the seismic specifications of most facilities that determine system performance predate current specifications. Basic specifications for anchorage, slack in bus connections, and equipment specifications will have to be defined. In light of past performance, these specifications may be modified on the basis of engineering judgment of the cost-effectiveness. This research would include the development of technical parts for a draft standard. It is the intent that these requirements be established for the first seven system elements. Element evaluation methods would include the definition of acceptable practices and may also include walkdown procedures for standardized element evaluation. A key element in improving seismic design practices is quality assurance to make sure that new procedures are implemented in the field. This issue should be addressed for incorporation into System Performance Evaluation Standard. This effort will also use research results developed on the Communications, Monitoring, Protection, and Control component described below. After developing element evaluation methods, they should be used for evaluating the system.

**Developers:** Electric Power and Communications Committee, TCLEE, or other group familiar with earthquake effects on power systems, seismic specifications of power facilities, and the historical development of seismic specifications used by major California utilities.

**Duration:** 1 year

**Cost:** \$260,000

(Basis of cost estimate: 10-person working group, has six two-day meetings over the interval. Travel cost--\$20,000 (the group would be concentrated on the West Coast). For this level of activity participants would have to be compensated for

## RECOMMENDATIONS FOR LIFELINE SEISMIC STANDARDS

*meetings and work assignments between meetings--\$240,000.)*

### **B. Develop Evaluation Methods For Critical Components And Seismically Hardened Power Paths**

Critical system elements need to be evaluated. In addition, critical components within the critical elements would have to be identified. An evaluation procedure should be formulated based on component specifications that are to be developed under equipment and material standards. While research will be needed to carefully review and determine critical components, several components would play a minor role. The most important components are in Transmission and Distribution Substations, Communication, Monitoring, Protection, and Control Facilities, and Emergency Planning and Response elements. Three tasks are to be performed under this research effort. Critical elements and critical components within the elements will be identified. A method for evaluating critical elements should be developed based on their basic seismic requirements and on equipment and material design specifications. Methods for identifying and evaluating seismically hardened power paths through substations are to be developed. Using the methods that are developed, the incremental cost associated with a seismically hardened power path as compared to a normal upgrade should be evaluated. In addition, methods for investigating postearthquake response of systems should be developed. Finally a draft, prescriptive evaluation procedure should be developed for evaluating critical elements.

**Developers:** Electric Power and Communications Committee, TCLEE, or other group familiar with earthquake effects on power systems, seismic vulnerability of power facilities and equipment, and power system operations.

**Duration:** 2 years

**Cost:** \$510,000

(Basis of cost estimate: 10-person working group, has 12 two-day meetings over the interval with two days' work between meetings. Travel cost--\$30,000 (the group would be concentrated on the West Coast). For this level of activity participants would have to be compensated for meetings and work assignments between meetings--\$480,000.)

### **C. Develop Procedures For Evaluating The Seismic Ruggedness And Integrity Of Communications Systems And Standards For New Construction**

Power system operation makes extensive use of communications for power dispatch, system protection, and system configuration modifications. Communication systems include utility-owned microwave system, leased telephone lines, public switch network system, carrier frequency communication on transmission lines, and radio communications. Repair and maintenance crew also make extensive use of radio communications.

One of the difficulties in dealing with this area is the lack of standardization and great variety of systems and approaches used by different utilities.

Evaluation procedures for existing facilities and standards for new construction for the following systems should be developed.

- Anchorage and installation (bracing and slack in electrical connections) of

## *ELECTRICAL POWER LIFELINES*

communications equipment including system PBX, and power plant and substation communication racks

- Emergency power supplies (reference Task IV-1(P), C)
- Base station and microwave antenna, particularly the security of signal leads
- Security of radio repeaters and their emergency power system
- Seismic security of key secondary systems, such as air-conditioning systems (for computer and communication equipment)

Special attention should be given to hidden dependencies, such as:

- Air-conditioning dependent on commercial water supply
- Critical equipment not on circuits supplied with emergency power (for example, air-conditioning)
- Computers not provided with uninterruptable power supplies
- Critical links of communications systems on public switch network that may be disrupted
- The use of Centrex for critical communications

In addition to the seismic security of the physical facilities described above, there is a need to assess problems of communication system capacity under postearthquake conditions and contingency procedures for managing any shortfall. Problems associated with radio communications are system saturation, and frequency compatibility with repair crew brought in from other utility districts or obtained through mutual aid. For radio communications, where channels usually get saturated, plans for managing capacity limitations, such as converting to a supervised network (need for training in the use of supervised network, etc.) need to be developed.

There is a need for contingency communication plans for independent co-generating plants that tie into the network. These facilities can be valuable and significant sources of power, but there is a need for secure communications.

For all of the above items (and others that have not been explicitly identified here) evaluation procedures must be established for existing facilities and standards developed for new construction. Implementation milestones must be established consistent with the overall timetable set in the Policy Statement Standard. The evaluation should be quantitative in character so that the results of the evaluation can be used to determine status of the implementation process. It should be noted that disaster response planning is most important in the early part of the standards implementation plan, since that is when the system is most vulnerable. Thus, low-cost items and procedures that can be implemented quickly should be put on a fast-track schedule. The procedures and standards should be formulated, to the degree possible, in a prestandard format.

**Participants:** The Utility Telecommunications Council, supplemented with experts on earthquake effects on power systems and communications equipment, or a group

## RECOMMENDATIONS FOR LIFELINE SEISMIC STANDARDS

of specialists in the various areas. Task groups within the overall effort will probably have to be formed.

**Duration:** 18 months

**Cost:** \$260,000  
(Basis of cost estimate: 12-person working group, has five two-day meetings over the interval with two days' work between meetings. Travel cost--\$20,000. For this level of activity participants would have to be compensated for meetings and work assignments between meetings--\$240,000.)

### D. Conduct Research On Monitoring, Protection, And Control Element

Monitoring, protection, and system control element deals both with system operations and many components that are vital to system operations. Because of the specialized character of the components contained in this element, a separate research effort is suggested. The results of this effort should be in the form of prestandards.

Seismic standards should be established for the energy control centers. Emphasis would be on installation of control, computer, and communication equipment, seismic security of the facility, emergency power for the facility. Minimum requirements should be established for an alternate energy control center. Other components should be reviewed and prestandards developed as appropriate.

**Developers:** Electric Power and Communications Committee, TCLEE (supplemented by system and protection specialists) or other group familiar with earthquake effects on power systems, seismic specifications of power facilities, and specialists on communications, protection, and control.

**Duration:** 9 months

**Cost:** \$140,000  
(Basis of cost estimate: eight-person working group, has four two-day meetings over the interval. Travel cost--\$10,000 (the group would be concentrated on the West Coast). For this level of activity participants would have to be compensated for meetings and work assignments between meetings--\$130,000.)

### Task III-2(D)--Develop Element Evaluation And Design Standards

The results of Tasks III-1(P), and V-1(P) should provide a basis for formulating an element evaluation and design standard.

**Developers:** It is not clear what organization would take responsibility for developing a consensus standard. IEEE or ASCE would be candidates.

**Duration:** 2 years (See Section II-3.5)

**Cost:** \$140,000 (See Section II-3.5)

#### II-3.5.4 Equipment And Material Standards

These standards establish seismic design criteria for new equipment or materials. These would be mandatory performance standard test methods or standards specification.

Major components of power system element are identified in Section II-1.1. Each should be reviewed to determine the need for seismic design standards. For selected topics, research or prestandard tasks are discussed in detail. An additional six items are grouped into a single task where issues associated with each are briefly described.

#### Task IV-1(P)--Develop Prestandard Equipment And Material Standards

##### A. Develop High-Voltage Substation Equipment Seismic Specifications

In this plan for standards development three classes of equipment are considered: commercial, engineered, and high-voltage substation equipment. The first two classes are discussed in Task IV-1(P),E, below. Damage to high-voltage substation equipment is the primary cause of earthquake-related power disruption.

A standard for seismic specification for procurement and installation of substation equipment should be developed. A standard design spectra shape should be developed for the specifications as well as standard points to anchor the spectra. Equipment for which analysis is acceptable for qualification should be identified as well as those items which require testing. Testing procedures are developed in Task IV-1(P),B. All power network substation and switchyard equipment would be governed by the standards.

Several issues should be addressed. Establishing a few *standard* spectra anchor points would be very beneficial to the industry. The fine-tuned adjustments of spectra by 0.2g or 0.1g or less is not meaningful when the uncertainty of ground motions is so large. All equipment should be evaluated with its support structure. Issues of anchorage strength and flexibility should be addressed. Common, poor design details, such as single-bolt friction clips and slotted bolted connections, should be eliminated. Seismic profile drawings that specify equipment weight, center of gravity, natural frequencies, and anchorage calculations should be required.

It would be desirable if the concept of two or three seismic classes of equipment could be promulgated. One class would be standard design. The second class (and the first class may be combined with this class) would be improved seismic ruggedness to the point that the incremental cost of manufacturing the item starts to become significant. The third class would have seismic ruggedness that could only be achieved with significant increase in cost. It would be desirable if a single ruggedness specification could be established, so that the special design and testing for a class would only have to be done once for each type of equipment.

Tasks within IV-1(P) should interact. In addition, issues of conductor flexibility should be addressed, and results should be presented in a prestandard format.

**Developers:** Electric Power and Communications Committee, TCLEE (supplemented with equipment and porcelain manufacturers), or other group familiar with earthquake effects on power system equipment.

**Duration:** 2 years

## RECOMMENDATIONS FOR LIFELINE SEISMIC STANDARDS

**Cost:** \$430,000  
(Basis of cost estimate: 12-person working group, has eight two-day meetings over the interval with two days' work between meetings. Travel cost--\$50,000. For this level of activity participants would have to be compensated for meetings and work assignments between meetings--\$380,000.)

### B. Test Standards

Major California utilities have developed seismic specifications for equipment that include testing. While these specifications have many similarities, methods of testing used by each utility are different. An industry standard should be established to reduce confusion among manufacturers, and to ultimately lower equipment cost and improve its seismic reliability.

There is a need to evaluate and standardize seismic testing of power equipment to meet design specifications. Several issues need to be addressed. Experience has shown that the use of analysis for some types of equipment cannot ensure good seismic performance. Such equipment must be tested to ensure acceptable seismic performance. It is generally agreed that random testing with spectra based on power spectral density or design spectra that have time histories that have been properly formulated provides the most reliable evaluation of equipment performance. The simultaneous excitation of all modes of vibration and interaction problems not found in sine-sweep or sine-beat tests are identified. Random vibrations are more characteristic of earthquake ground motions. However, vibration tables with a capacity to test large equipment with random excitation are limited, and tests tend to be more expensive. There is also the question as to the number of axes that should be tested simultaneously. The standardization of test format (energized, pressurized, changes in operating state) and methodologies (sine-sweep, sine-beat of specific size and duration, random with appropriate designed time history) for meeting seismic design specifications in the long run will simplify testing and yield results that can be compared. Ideally, a single test format should be established. This does not mean that all equipment would be designed to the same seismic level. If needed, a testing program should be used to identify the most appropriate test method.

**Participants:** Consortium of porcelain manufacturers, power equipment manufacturers, utilities, and EPRI.

**Duration:** 2 years

**Cost:** \$350,000  
(Basis for this effort is that it will require a two-person/year effort. The test program would require an additional \$150,000.)

### C. Develop Prestandard For Emergency Power Backup Equipment

The frequent failure of emergency power demonstrates that common practices are inadequate. Detailed design specifications addressing all the special issues for this important class of equipment should be developed. Issues to be considered include restraints or snubbers of vibration-isolated units, need for engine and generator to be rigidly attached to a single support, adequate flexibility and slack in utility (power, water, fuel, exhaust) connections, anchorage of day tank, integrity of cooling system, integrity and operation of fuel supply to day tank, anchorage of control panels and start-up batteries, periodic testing procedures and circuits, seismic integrity of start-up systems, and quality assurance of diesel fuel over time.



## ELECTRICAL POWER LIFELINES

**Developers:** Electric Power and Communications Committee, TCLEE, or other group familiar with earthquake effects on emergency power systems.

**Duration:** 6 months

**Cost:** \$60,000  
(Basis of cost estimate: four-person working group, has three two-day meetings over the interval with two days' work between meetings. Travel cost--\$10,000. For this level of activity participants would have to be compensated for meetings and work assignments between meetings--\$50,000.)

### D. Design Standards For Service Facilities And Spare-Part Storage

Seismic standards for installation and emergency power for radio communications systems used by maintenance should be established. Seismic standards should be developed for maintenance facility computer systems. This should include system databases and computer-based, work-order systems. There is a need for standards for securing spare parts and equipment in storage facilities and in open storage. Buildings used for storage are discussed below.

**Developers:** Electric Power and Communications Committee, TCLEE, or other group familiar with earthquake effects on emergency power systems.

**Duration:** 6 months

**Cost:** \$40,000  
(Basis of cost estimate: four-person working group, has two two-day meetings over the interval with two-days' work between meetings. Travel cost--\$10,000. For this level of activity participants would have to be compensated for meetings and work assignments between meetings--\$30,000.)

### E. Develop Prestandard Documents For Selected Equipment Items

The seismic performance of the six items listed below has generally been good; however, there are some outstanding seismic issues. There is a brief discussion of issues associated with each item.

- **Power Generating Plants**--The present procedure of using the UBC has provided good seismic performance. A supplementary standard is needed for addressing coal-handling equipment and special problems associated with restraining the boiler in the boiler support structure. Most utilities have dispersed power-generating sources so that it is unlikely that several would be damaged by a single event. A simple procedure should be developed for determining if a utility has a high percentage of generating capacity concentrated in a small area so that adequacy of alternate supplies could be checked.
- **Transmission Line Towers**--Present design practice, which is governed by wind, ice, and broken wire loads has provided good seismic performance. Existing standards should be supplemented to deal with sites with liquefiable soils. It is suggested that guidance be given so that the designer is aware of the issue and has the option to take action in the special cases of very vulnerable towers on important lines. The use of grade beams between footings to enhance

## RECOMMENDATIONS FOR LIFELINE SEISMIC STANDARDS

tower stability or piles that consider liquefaction might be suggested.

- **Distribution Lines And Distribution System Equipment**--In general, distribution equipment performs well in earthquakes. There should be a standard for anchoring vault, pole- and platform-mounted transformers.
- **Commercial Equipment**--In general, commercial equipment has performed well. Equipment should be reviewed for special situations where there are inadequacies. Examples are vibration-isolated components in HVAC equipment and anchorage of computer terminals and monitors.
- **Buildings**--While building codes govern buildings, as noted earlier, they set minimum standards for life-safety. The question of operability of the facilities should be addressed directly.

**Developers:** Electric Power and Communications Committee, TCLEE, or other group familiar with earthquake effects on power systems.

**Duration:** 1-1/2 years

**Cost:** \$120,000  
(Basis of cost estimate: eight-person working group, has three two-day meetings over the interval with two days' work between meetings. Travel cost--\$20,000. For this level of activity participants would have to be compensated for meetings and work assignments between meetings--\$100,000.)

### **Task IV-2(R)--Conduct Research Into The Strength And Reliability Of Porcelain Members**

There is a need for a better definition for the performance of porcelain members, improved standards for testing these components, and well-defined, technically sound methods for specifying their factors of safety.

Many brittle materials, such as porcelain, exhibit large variability in strength. Typical test methods that require only three test samples raise questions on the precision of estimates of the factor of safety used for these materials. It is not clear if each manufacturer expresses the strength of items in a consistent manner. Also, for many items, specifications are given in terms of cantilever strength; however, earthquake-induced loads should take into account the distribution of mass of the item. Porcelain not only has a high inherent variability of strength, but its characteristics can vary from batch to batch. It is not clear if this component of variability of strength is reflected in catalog specifications. There is a need to standardize terms and develop specifications that accurately reflect the seismic resistance and factors of safety associated with porcelain items. A test program should be used to evaluate small-size porcelain members to validate manufacturer catalog strengths.

**Participants:** Consortium of porcelain manufacturers, power equipment manufacturers, utilities, and EPRI.

**Duration:** 1-1/2 years

**Cost:** \$260,000

(Basis for this effort is that it will require a two-person-man/year effort. An additional \$60,000 is to be used for the test program.)

**Task IV-3(R)--Conduct Research On Testing Transformer Bushings**

There have been several cases of earthquake-induced transformer bushing leaks and damage. There are no ways to work around a loss of transformer functions as there are for most other substation damage. There is a need to establish failure mechanisms and test procedures for evaluating transformer bushings. Because of the size of many substation transformers, it is difficult or impossible to test the entire transformer. The product of this effort should be guidance for establishing transformer bushing specifications.

**Participants:** Consortium of porcelain manufacturers, power equipment manufacturers, utilities, consultants, and EPRI.

**Duration:** 1 year

**Cost:** \$280,000  
(Basis for this effort is that it will require a two-person/year effort. An additional \$80,000 is allocated for the testing program.)

**Task IV-4(R)--Conduct Research Into Dynamic Loads Imposed By Buses And Bus Connections**

Guidance is needed for determining slack and flexibility in bus-equipment connections. Several bus-equipment connections have failed in earthquakes. The details of the designs associated with these failures should be evaluated to see if they can be incorporated into standards practice under controlled conditions, in configurations, as appropriate. The use of breakaway connections may also have an influence on substation layout. One of the key issues that should be addressed is associated with bus dynamics during short-circuit loads when extra bus slack and flexibility is introduced. The output of this effort should be guidance for installation standards.

**Participants:** Consortium of porcelain manufacturers, power equipment manufacturers, utilities, and EPRI.

**Duration:** 1-1/2 years

**Cost:** \$200,000  
(Basis for this effort is that it will require a two-person/year effort.)

**Task IV-5(R)--Conduct Research Into Postearthquake Evaluation Of Equipment And Facilities**

Research is needed to establish procedures for evaluating equipment, facility, and system response to determine if the seismic design standards are adequate and appropriate. Methods for documenting results should be established. Emphasis for developing detailed procedures for evaluating damage would primarily be on substation damage. This effort should include the exploration of methods of protecting results of the investigation from discovery.

**Participants:** Earthquake Investigation Committee, TCLEE, or other group familiar with earthquake effects on power systems, and power system equipment.

## *RECOMMENDATIONS FOR LIFELINE SEISMIC STANDARDS*

**Duration:** 1-1/2 years

**Cost:** \$120,000  
(Basis of cost estimate: five-person working group, has five two-day meetings over the interval with two days' work between meetings. Travel cost--\$20,000. For this level of activity participants would have to be compensated for meetings and work assignments between meetings--\$100,000.)

### **Task IV-6(D)--Develop Emergency Power Backup Equipment Standards**

Results of IV-1(P),C, should provide a basis for formulating a standard for emergency power equipment.

**Developers:** It is not clear what organization would take responsibility for developing a consensus standard. IEEE or ASCE would be candidates.

**Duration:** 2 years (See Section II-3.5)

**Cost:** \$140,000 (See Section II-3.5)

### **Task IV-7(D)--Develop Equipment And Material Standards**

The results of Task IV-1(P) should provide a basis for formulating an equipment and material standard.

**Developers:** It is not clear what organization would take responsibility for developing a consensus standard. IEEE or ASCE would be candidates.

**Duration:** 2 years (See Section II-3.5)

**Cost:** \$140,000 (See Section II-3.5)

### **II-3.5.5 Disaster Response Planning Standard**

This standard defines good practice for enhancing seismic emergency response. In addition to plans, related facilities should also be addressed. A schedule of milestones should be established to ensure the completion time given in the policy statement standards is met.

Power utilities have emergency response plans that are regularly used for the many contingencies that befall utilities. In most regions of the country these plans do not adequately address the special issues associated with earthquakes and particularly great earthquakes. Issues dealing with the following areas should be addressed: communications, Service or maintenance centers, spare parts storage, emergency power sources, customer service centers, access to engineering documentation, seismic hardening of the energy control center, alternate energy control center, emergency operations center, corporate recovery plans, and the differences in the character of earthquake damage (damage to substation equipment) as compared to that associated with more traditional emergencies (damage to lines).

**Task V-1(P)--Develop Prestandard Disaster Response Planning Standard**

There are two aspects of disaster response standards that must be considered and integrated: facilities associated with the emergency response and operating procedures to address the emergency.

**A. Develop Procedures For Evaluating Existing Facilities Related To Disaster Response And Standards For New Construction Of These Facilities**

The following facilities are to be considered: energy control center, alternate energy control center, emergency operations center, emergency power supplies, service centers, customer service centers, and spare parts storage (in storage facilities and in open storage), and facilities for black start of generating plants. In addition, potential hidden dependencies of facilities will have to be identified.

Associated with each facility are several special concerns. Many of these can be established by reviewing seismic performance of these facilities.

For each of these facilities evaluation procedures and standards must be established for existing facilities and new construction. Implementation milestones must be established consistent with the overall timetable set in the Policy Statement Standard. The evaluation should be quantitative in character so that the results of the evaluation can be used to determine status of the implementation process. It should be noted that disaster response planning is most important in the early part of the implementation plan since that is when the system is most vulnerable. Thus, low-cost items and procedures that can be implemented quickly should be put on a fast-track schedule. The procedures and standards should be formulated, to the degree possible, in a prestandard format.

**B. Improve Disaster Response Plans**

Earthquakes primarily damage high-voltage substation equipment, while most other emergencies that befall power systems are related to the loss of transmission or distribution lines. Problems with the availability of spare parts and equipment, and difficulties with transporting and installing a significant number of high-voltage equipment items at several substations, is outside of the experience of most utilities.

The impact on the utility and the community that it serves may require policy decisions from management on a continuing basis during the emergency response and recovery. A disaster, unlike emergencies that regularly affect utilities, requires much more coordination within various parts of a large utility and between the utility and groups outside of the utility. As noted above, the execution of these activities requires an emergency operating center with the requisite communications and computer systems.

Another component that is external to the utility are the independent co-generating plants that are tied into the power network. They are relatively new players on the scene, but can have an important role in the emergency response and recovery. There is a need for contingency plans for the interaction with these facilities in a disaster. For many utilities they are valuable and significant sources of power. In addition to communications noted above, there is a need to prearrange waivers for certain contractual restrictions that limit the operation of these facilities. (For example, the facility associated with the co-generating unit may be closed, but the co-generating unit can only operate if it supplies power to its facility.)

## RECOMMENDATIONS FOR LIFELINE SEISMIC STANDARDS

Guidelines for evaluating and improving disaster planning should be put in the form of a prestandard. The guidelines should identify the special problems caused by earthquakes that are not typically addressed in existing emergency response plans. Approaches to these problems should be suggested but must be sufficiently flexible so that they can be applied to different utilities throughout the country and to different organizational structures. The standard should require that the plan be periodically tested through simulation exercises. Implementation milestones must be established consistent with the overall timetable set in the Policy Statement Standard. The evaluation should be quantitative in character so that the results of the evaluation can be used to determine status of the implementation process.

**Participants:** Because of the special character of many of these facilities and functions, a diverse group of specialists in the various areas will be needed. This includes facility planners, design engineers, people from operations, and individuals who have practical earthquake disaster experience. Members of the Utility Policy Committee, a California utility group, could also be involved.

**Duration:** 2 years

**Cost:** \$320,000  
(Basis of cost estimate: 18-person working group, has four two-day meetings over the interval with two days' work between meetings. Travel cost--\$30,000. For this level of activity participants would have to be compensated for meetings and work assignments between meetings--\$290,000.)

### **Task V-2(D)--Develop Disaster Response Planning Standard**

The results of Tasks V-1(P) should provide a basis for formulating a disaster-response-planning standard. This standard should specify how information determined in evaluating system elements is used to determine if the policy statement is satisfied.

**Developers:** It is not clear what organization would take responsibility for developing a consensus standard. IEEE or ASCE would be candidates.

**Duration:** 2 years (See Section II-3.5)

**Cost:** \$140,000 (See Section II-3.5)

### **II-3.6 Postearthquake Evaluation**

An important element in the continued improvement of earthquake performance, mitigation, and emergency response is the postearthquake investigation of earthquakes. There are several issues related to postearthquake investigations.

There is a need for personnel at each damaged facility to take pictures of damage prior to cleanup. In many cases, cleanup will proceed before a facility can be investigated. Clearly, cleanup and restoration cannot wait for an investigation; therefore, it would be desirable for local personnel to document damage. While pictures taken by an individual not familiar with the procedures or intent of an investigation may be wanting, they will be better than no record.

After a damaging earthquake, personnel from the impacted utilities are too busy restoring service

## *ELECTRICAL POWER LIFELINES*

to do a detailed investigation. A fast-response team is needed because damaged equipment is removed quickly. As a result, details, such as failure mode and factors that may have contributed to the failure, are more difficult or impossible to discover.

A thorough investigation will increase knowledge of the causes of failure so that the state of the art of enhancing earthquake resistance of power facilities can advance.

In recent earthquakes, there has been an increasing concern about liability with a tendency to limit access of postearthquake investigators. Several issues are involved and the legitimate interests of those involved are sometimes in conflict.

For most utilities, the ultimate responsibility of activities at a facility usually rests with the facility manager. Giving access to outsiders, no matter what their credentials, will in general require that they be escorted in the facility. This will divert resources from recovery operations, although an escort need not be the most skilled personnel at the site. The investigators would also want to interview key personnel, and this may be disruptive to the recovery. Clearly, ground rules for conducting an investigation would have to be established.

There is the potential of the investigator's being injured in the rush of activities to restore service. Often there will be heavy equipment in action and there is the chance of aftershocks that can cause additional damage. Investigators are exposing themselves to added risks by undertaking an investigation, and this should be explicitly documented to relieve the impacted utility.

The most difficult issue is the potential for external litigation associated with power disruptions. With the general tendency toward litigation, it is not unreasonable to anticipate litigation associated with power disruption. In this environment it is appropriate for a utility to impose some controls to assure that accurate information is made available about earthquake damage and system response. Balanced against this legitimate utility interest to limit disclosure is the need to know if seismic standards are adequate so that the state of the art can advance.

It would be desirable to explore methods for obtaining damage information that protect the legitimate interests of utilities.

Two alternatives may partially address this issue, if they can be implemented: One approach would be to put the results of the investigation into a general database on observations of the impact of earthquakes on power systems. Periodically, conclusions from observations from earthquakes, possibly including foreign events would be used to evaluate and update standards. The frequency of earthquakes is such that immediate results are not needed. While this approach would eliminate the issuing of a report that may serve to feed litigations, it is not clear if observations would not be subjected to discovery.

Another method would be to institute a system that seemed operable in the elevator industry in California about 20 years ago. In recognition of the public interest of full disclosure, establish a public policy that postearthquake investigation reports are not subject to discovery.

There is a need to develop two types of information relative to postearthquake investigations. There is a need for evaluating system response to earthquakes. Activities associated with this are described in Section II-3.5.3. There is a need to establish methods for investigating and documenting power system damage. Activities associated with this are described in Task IV-5(R) in Section II-3.5.4.

## RECOMMENDATIONS FOR LIFELINE SEISMIC STANDARDS

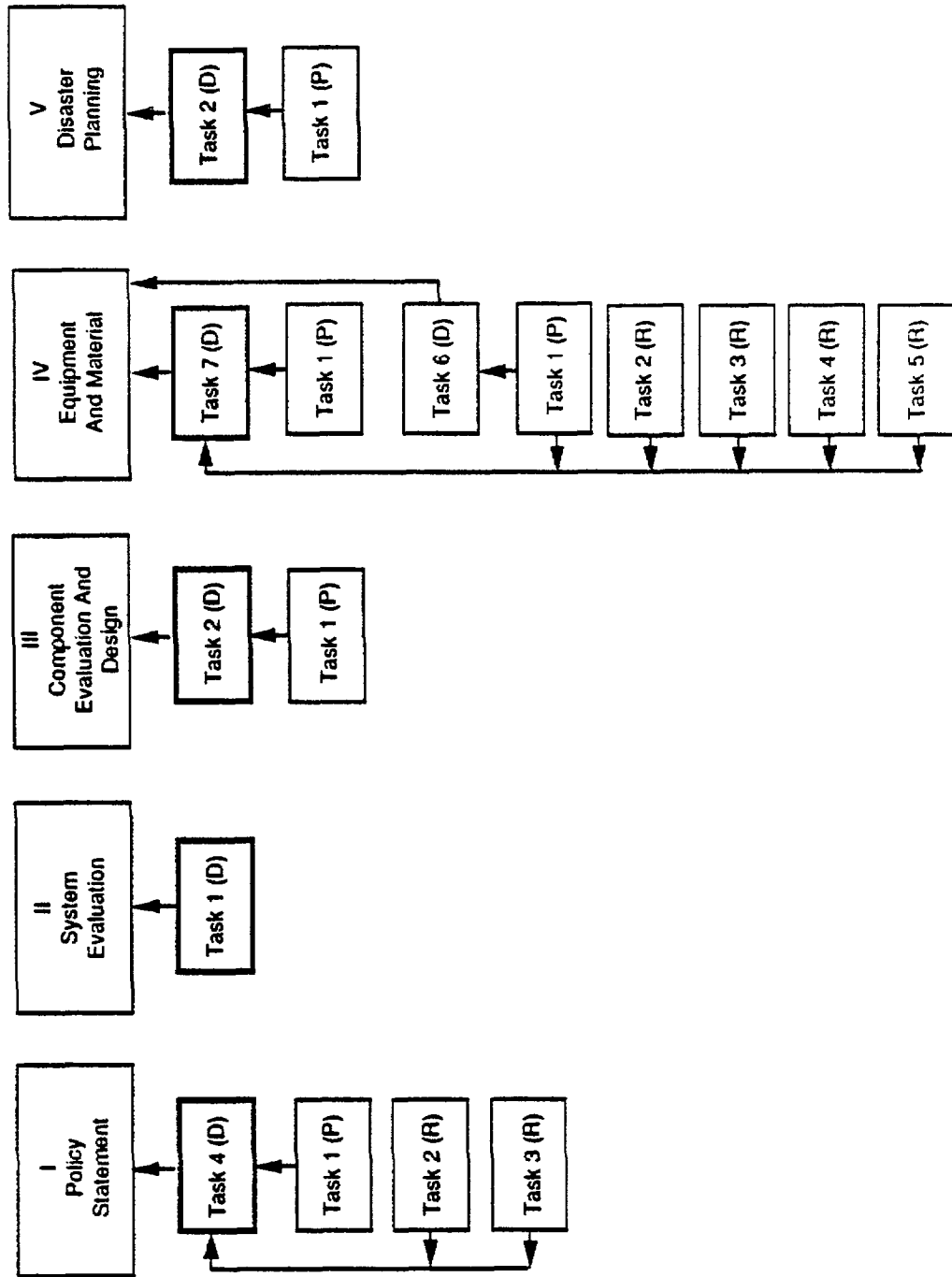
### II-3.7 Overall Schedule And Budget

Chart 1 gives an overview of the power system standards parts and identifies each of the tasks needed to develop the standards. Chart 2 shows the interactions between development tasks. As noted in Section II-3.5, several activities may be grouped into a single task to facilitate the overall development. The arrows on the chart indicate the relationship between the tasks and the parts of the standard. Table 1 lists each task, assigns it a priority, and indicates a possible development schedule.

One of the difficulties in implementing the above tasks is that the number of individuals with the needed expertise on power systems and earthquakes is very limited. As this effort gets started, additional technical resources should develop, but the success of this effort is difficult to predict. With the resources available, the phased implementation for the above plan should be completed within the eight-year target time window. The total rough estimate of cost is \$5,040,000. Of this total, \$3,350,000 is associated with standards development, and \$1,490,000 is associated with research.

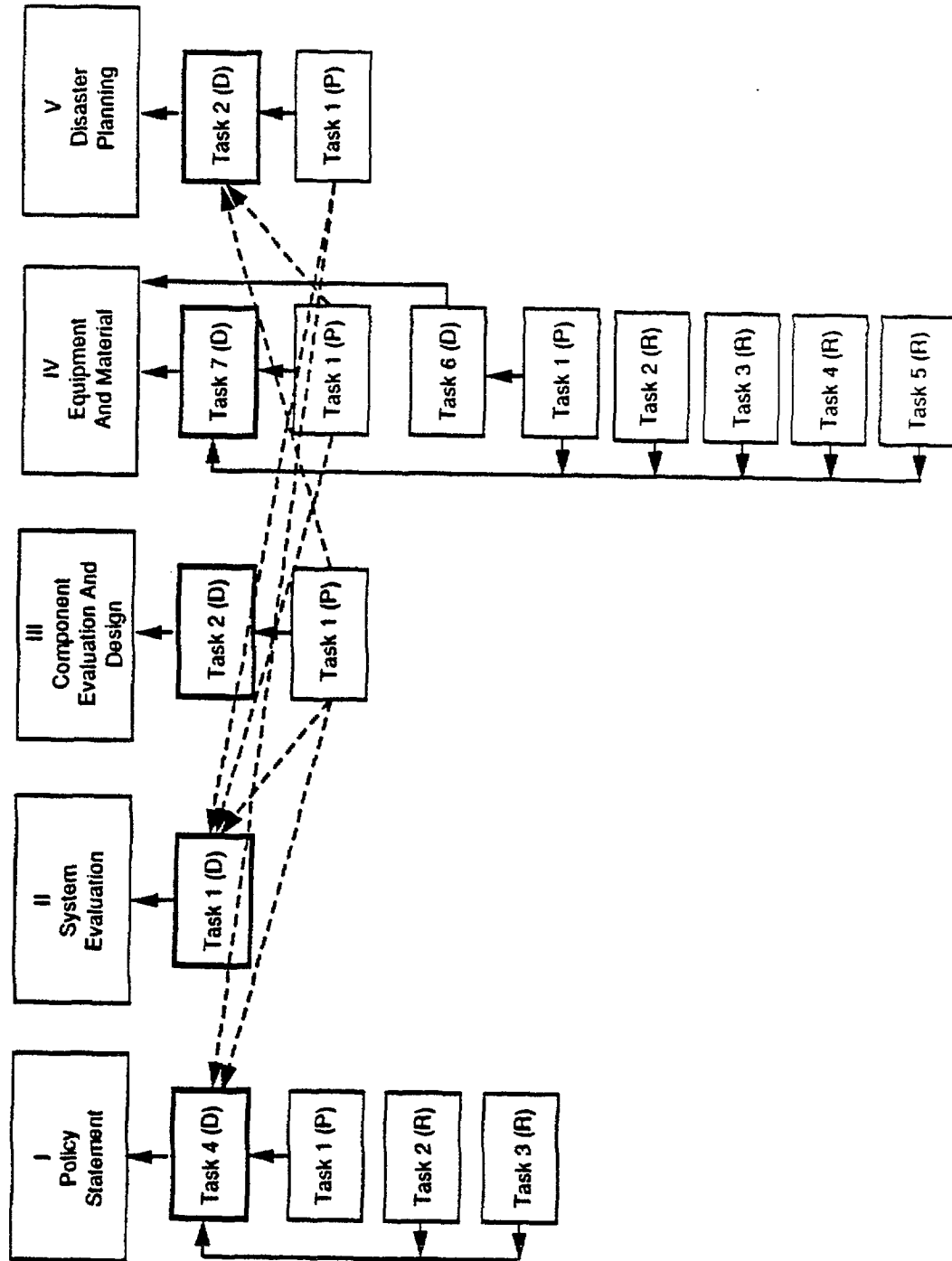


CHART 1  
POWER SYSTEM STANDARD PARTS AND DEVELOPMENT TASKS



RECOMMENDATIONS FOR LIFELINE SEISMIC STANDARDS

CHART 2  
POWER SYSTEM STANDARD DEVELOPMENT TASKS INTERACTIONS



**TABLE 1**  
**STANDARD DEVELOPMENT PRIORITIES AND SCHEDULE**

Standard Parts & Tasks	Priority	Cost (x \$1,000)	Schedule Period (1-year intervals)					
			1	2	3	4	5	6
<b>I. Policy Statement</b>								
Task 1A(P)	1	110	X					
Task 1B(P)	1	110	X					
Task 2(R)	2	80	X					
Task 3(R)	3	550			X	X		
Task 4(D)	1	140			X			
<b>II. System Evaluation</b>								
Task 1(D)	1	140						X
<b>III. Element Evaluation &amp; Design</b>								
Task 1P(A)	1	260	X					
Task 1P(B)	1	510		X	X			
Task 1P(C)	1	260	X	X				
Task 1P(D)	1	140	X					
Task 2(D)	1	140				X	X	
<b>IV. Equipment &amp; Material</b>								
Task 1P(A)	1	430	X	X				
Task 1P(B)	1	350	X	X				
Task 1P(C)	1	60	X					
Task 1P(D)	1	40	X					
Task 1P(E)	1	120		X	X			
Task 2(R)	1	260	X	X				
Task 3(R)	1	280	X					
Task 4(R)	1	200	X	X				
Task 5(R)	2	120		X	X			
Task 6(D)	1	140		X				
Task 7(D)	1	140		X	X			
<b>V. Disaster Planning</b>								
Task 1(P)	1	320	X	X				
Task 2(D)	1	140	X	X				

Priorities range from 1 to 3, with 1 the highest.

## RECOMMENDATIONS FOR LIFELINE SEISMIC STANDARDS

### II-4. ACKNOWLEDGMENTS

The author wishes to acknowledge the technical review of Ed Matsuda, Pacific Gas and Electric; Dennis Ostrom, Southern California Edison Co.; and Ron Tognazzini, Los Angeles Department of Water and Power (who are also members of the Electric Power and Communications Committee of TCLEE); and Jim Beavers, Martin Marietta Energy Systems.

### II-5. REFERENCES

- American Society of Civil Engineers (ASCE), 1980, "Bibliography on Earthquakes and Power Systems," Annotated Bibliography on Lifeline Earthquake Engineering, Technical Council on Lifeline Earthquake Engineering.
- American Society of Civil Engineers (ASCE), 1983, "Advisory Notes on Lifeline Earthquake Engineering," Technical Council on Lifeline Earthquake Engineering.
- Applied Technology Council (ATC), 1991, "Seismic Vulnerability and Impact of Disruption of Lifelines in the Conterminous United States," ATC 25, Redwood City, California (Draft).
- Benfer, N.A., 1973, "San Fernando, California, Earthquake of February 9, 1971," U.S. Dept. of Commerce, National Oceanic & Atmospheric Administration, Washington, D.C.
- Duke, C.M., 1977, "The Current State of Knowledge of Lifeline Earthquake Engineering," Technical Council on Lifeline Earthquake Engineering Speciality Conference, Los Angeles, CA, August 30-31, 1977.
- Earthquake Engineering Research Institute, 1973, "Managua, Nicaragua, Earthquake of December 23, 1972," EERI Conference Proceedings, San Francisco, Vol. II, Nov. 1973.
- Electric Power Research Institute (EPRI), 1988, "Electrotechnology Reference Guide," Rev. 1, Palo Alto, California.
- Federal Emergency Management Agency (FEMA), 1987, "Abatement of Seismic Hazards to Lifelines: An Action Plan," FEMA-142, August 1987.
- Federal Emergency Management Agency (FEMA), 1987, "Abatement of Seismic Hazards to Lifelines: Proceedings of a Workshop on Development of an Action Plan," Vol. 4, FEMA-138, July 1987.
- Federal Emergency Management Agency (FEMA), 1989, "Earthquake Hazard Mitigation for Utility Lifeline Systems," FEMA, IG 371, April 1989.
- Jennings, P.C., "Engineering Features of the San Fernando Earthquake, February 9, 1971," Earthquake Engineering Research Laboratory, California Institute of Technology, EERL 71-02, Pasadena, June 1971.
- National Oceanic and Atmospheric Administration (NOAA), 1972, "A Study of Earthquake Losses in the San Francisco Bay Area."
- Pierre, J.R., 1989, "Comportment Des Postes Et Expertise Des Dommages Causés Par Le Tremblement De Terre Du 25 November, 1988," Hydro-Quebec.

- Schiff, A.J., 1976, "Evaluating Power Systems Response to Earthquakes Using Simulation," Proceedings of the U.S. Japan Seminar on Earthquake Engineering Research with Emphasis on Lifeline System, Tokyo, Japan, November 8-12, 1976, pp. 305-316.
- Schiff, A.J., 1978, Personal observation.
- Schiff, A.J., Newsom, J.D., and Torres, R.E., 1979, "Fragility of Electrical Power Equipment," Journal of the Technical Councils, TC2, ASCE, December 1979, pp. 451-455.
- Schiff, A.J., 1985, "The Morgan Hill Earthquake of April 24, 1984 - Investigation of Lifelines," Earthquake Spectra, Vol. 1, No. 3, May 1985.
- Schiff, A.J., 1988, "The Whittier Narrows, California, Earthquake of October 1, 1987 - Response of Lifelines and Their Effect on Emergency Response," Earthquake Spectra, Vol. 4, No. 2, 1988.
- Schiff, A.J., 1989, "Lifeline Response to the Tejon Ranch Earthquake," Earthquake Spectra, Vol. 5, No. 4, November 1989, pp. 791-812.
- Schiff, A.J., 1990, "Loma Prieta Earthquake Reconnaissance Report - Performance of Elevators," Earthquake Spectra, Supplement to Vol. 6, May 1990, pp. 364-376.
- Schiff, A.J., 1991a, Personal communications with Dennis Ostrom, Southern California Edison.
- Schiff, A.J., 1991b, Personal communications with A. Shah, ASCE Standards.
- Schiff, A.J., 1991c, "Guide to Post-Earthquake Investigation of Lifelines," ASCE, TCLEE Monograph No. 3, 1991.
- Schiff, A.J., 1991d, Personal communications with W. Hays, USGS.
- Schiff, A.J., 1991e, "Seismic Design Practices of Power Systems: Evolution, Evaluation, and Needs," TCLEE, ASCE, Monograph 4, August 1991.
- Smith, Jr., D.J., 1981, "Lifeline Earthquake Engineering: The Current State of Knowledge," Technical Council on Lifeline Earthquake Engineering Speciality Conference, ASCE, Oakland, CA, August, 1981.
- Yokel, F.Y., 1990, "Earthquake Resistant Construction of Electric Transmission and Telecommunication Facilities Serving the Federal Government," U.S. Dept. of Commerce, National Institute of Standards and Technology, FEMA-202, Sept. 1990.

## RECOMMENDATIONS FOR LIFELINE SEISMIC STANDARDS

### II-6. APPENDICES

#### Appendix A: Electrical Power System Elements And Components

From an overall physical perspective, power systems consist of a number of nodes (substations and power-generating stations), which are typically interconnected by redundant networks of transmission and subtransmission lines forming a grid network. Emanating from some nodes (distribution substations) are radial systems (tree networks with little or no redundancy) of feeder lines and service lines that carry power to users. It should be noted that the nomenclature used to designate some parts of the system varies between utilities. In the descriptions that follow, typical facilities and situations will be discussed. Some utilities organize their systems in different ways to better address their particular needs.

Based on a similarity of function and elements, power systems can be divided into six major groups: power-generating facilities, transmission and distribution substations, lines, transmission and distribution control and data acquisition systems, maintenance support facilities, and technical support facilities.

In addition to a single utilities system, utilities are closely integrated into a regional network through the power grid. The North American Electric Reliability Council facilitates regional planning and coordination.

#### Power-Generating Facilities

The vast majority of power generation is based on fossil fuel-fired power plants. Nuclear generation contributes about 15 percent of the total sources, followed by hydro-electric generation. Geothermal, wind, and solar contribute relatively small percentages of the total generating capacity. The mix of energy sources varies significantly from utility to utility, with some deriving as much as 50 percent from nuclear or about 10 percent from hydro. In addition, diesel, or more commonly, gas turbine units are used for peaking power, that is, used for limited times during the day to supply power during peak load periods.

#### Transmission And Distribution Substations

Transmission and distribution substations have been grouped together, since they contain equipment that has the same function, although transmission equipment operates at high voltages and carries more power. The following equipment is usually found within substations. Only major items of equipment or items that have been damaged in earthquakes are discussed.

- Circuit breakers are used for system protection to open a circuit under a variety of conditions as determined by the system protection and control components.
- Transformers (power transformers) are used to transmit power between two circuits at different voltages.
- Capacitive-coupling voltage transformers are used to measure voltage on a high-voltage line. The values measured are used for monitoring and control of the power system.

## *ELECTRICAL POWER LIFELINES*

- Current transformers are used to measure currents flowing in high-voltage lines. The values measured are used for monitoring and control of the power system.
- Disconnect switches are used to open a circuit when the circuit is de-energized. Disconnect switches are used to isolate items of equipment or connect segmented buses.
- Wave traps are inductors used to filter out high-frequency carrier signals carried on transmission lines used primarily for communications associated with system protection.
- Lightning (or surge ) arrestors are used to limit excessive voltage on a line to protect substation equipment.
- Post insulators are ceramic members used to support energized components and isolate them from grounded structures. They are used to support bus runs, and are part of wave-trap and disconnect-switch assemblies.
- Capacitor racks (including the capacitors supported by the rack) are used for several purposes, including voltage support, power-factor adjustment, and filtering.
- Station batteries are used to provide backup power for control, monitoring, and communications at the substation.

### **Transmission And Distribution Lines**

The voltages that distinguish transmission, subtransmission, and distribution lines varies from utility to utility. The vast majority of transmission lines are AC, with voltages up to 765 kV. There are several DC transmission lines, but they carry a relatively small percentage of total electrical power. Most transmission lines are carried on lattice or tubular steel support structures. Most are self-supporting structures, although guyed towers are also used. At lower transmission voltages (around 230 kV and below) more than one circuit may be carried on a single tower. Lines that feed distribution substations typically range between 60 kV and 110 kV. Most feeder lines emanated from distribution substations range from 4 kV to 16 kV, but these voltages have tended to increase to 34 kV in recent years. Feeder lines are typically carried on wooden poles and within dense population centers are now typically buried.

### **Communication, Monitoring, Protection, And Control Facilities**

In modern power systems the energy control center or dispatching center continuously monitors the condition of the power network through measuring devices distributed throughout the system and a network of communication systems that transfers the data back to the energy control center. On the basis of this data, computers adjust the power output of power-generating stations to keep power generation in balance with load. The energy control center will also open and close circuits (usually through manual intervention rather than by computer) as needed for system maintenance or network management.

## *RECOMMENDATIONS FOR LIFELINE SEISMIC STANDARDS*

An extensive communications network is an important part of the control system. It is used to transfer system status data, system control information, and system protection information, as well as for voice communication between the energy control center, power-generating stations, and substations. These systems typically consist of a combination of a utility-owned microwave network, private and leased telephone lines, power-line carrier channels, and radio links. Because of the importance of the control facilities they are usually provided with emergency backup power, and are often designed to higher design criteria, and sometimes provided with special security. Major California utilities have alternate energy control centers that can be activated in the event that the primary center is rendered inoperative (earthquake risks have been the major motivation for developing alternative energy control centers).

### **Maintenance Support Facilities**

Maintenance facilities, stores of spare equipment, and spare parts will play an important role in restoring service after a damaging earthquake. An integral part of the maintenance function are work areas for maintenance personnel, computer workstations and databases, and radio communications network for communication to service vehicles.

### **Technical Support Facilities**

Should the power system experience severe damage, basic engineering design drawings must be available. These are usually stored in engineering design offices rather than maintenance centers.

### **Other Functions**

Corporate management must be available, in the event of major system damage, to make strategic decisions and secure and distribute emergency funds for repair. For example, it has been estimated that the Loma Prieta earthquake caused about \$100 million damage to Pacific Gas and Electric Co. In addition, arrangements had to be made with other utilities to secure replacement equipment, which they happened to have available for the construction of new facilities.

### **Regional Power Network Coordination And Reliability**

The operation of a modern power grid requires the coordination and cooperation of all utilities in the region. As a result of the Northeast Blackout in 1965, a national reliability organization was formed. This has evolved into the North American Electrical Reliability Council (NERC), a voluntary, private organization of utilities in the United States, and parts of Canada and Mexico. Within the United States there are nine Regional Reliability Councils. For example, in the western United States the Western States Coordinating Council (WSCC) was formed to address regional system problems. This region includes all or parts of 11 states and extends into Canada and Mexico.

### **Appendix B: Summary Of Earthquake Power System Damage**

- **1971 San Fernando Earthquake**--Major damage to a DC converter station occurred. Eighteen months were required to restore the facility to full service. There was also damage to equipment operating at 230 kV or above at several substations.



## ELECTRICAL POWER LIFELINES

- **1984 Morgan Hill Earthquake**--Live-tank circuit breakers (500 kV) were damaged at two substations. Damage at one substation resulted in the disruption of one of the two AC Pacific interties for several days (Schiff 1985.)
- **1986 North Palm Spring Earthquake**--There was major damage to 500 kV substation equipment that was designed using improved seismic design practices instituted after the San Fernando earthquake. There was also damage to 230 kV substation equipment. With a concerted restoration effort, the system capacity was restored in 10 days.
- **1987 Whittier Narrows Earthquake**--Equipment (230 kV) at several substations was damaged or put out of service (Schiff 1988). Unreinforced masonry substation control houses were also damaged. Service center communications were disrupted. The main corporate offices of a utility experienced some structural damage.
- **1988 Tejon Ranch Earthquake**--A switchyard at a pump-station on the California Aqueduct was severely damaged (230 kV live-tank circuit breakers). The aqueduct was closed for four days until emergency repairs could be made to partially restore switchyard operation (Schiff 1989).
- **1988 Saguenay Earthquake (Eastern Canada)**--Damage to three substations (circuit breakers and transformers) at 300 kV and 735 kV at epicentral distances up to 180 km (Pierre 1989).
- **1989 Loma Prieta Earthquake**--A large earthquake centered some distance from San Francisco caused major damage to three substations. Using emergency operating procedures, service was restored to most areas in less than one day; however, emergency procedures had to be used for several weeks (Schiff 1990).
- **1991 Sierra Madre Earthquake**--Three 230 kV circuit breakers were damaged. Power was temporarily disrupted to parts of Pasadena, California.
- **Foreign Earthquakes**--Not listed here is damage to power system facilities in Japan, Chile, U.S.S.R., and New Zealand from earthquakes that have occurred during this time interval.

*RECOMMENDATIONS FOR LIFELINE SEISMIC STANDARDS*

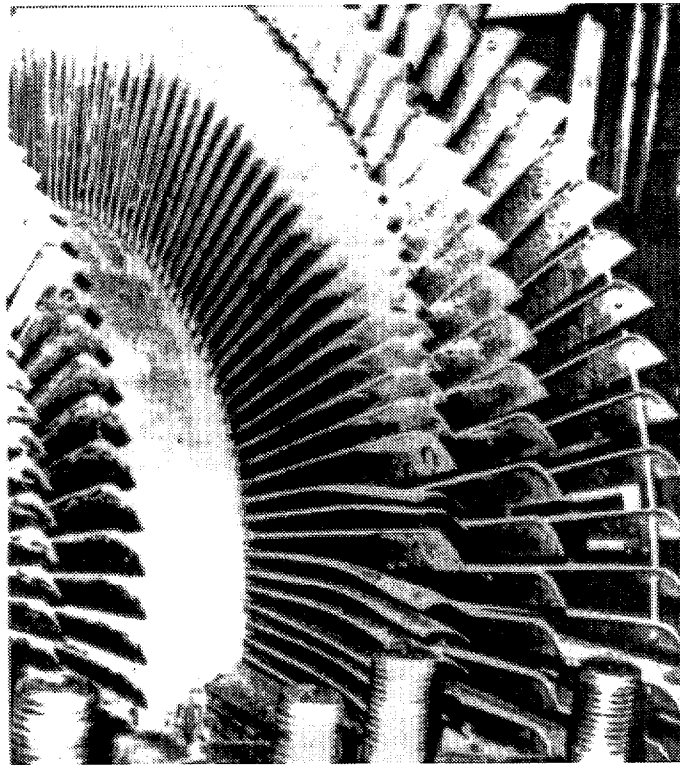


Figure 1. Damage to turbine in the 1972 Managua, Nicaragua, earthquake.

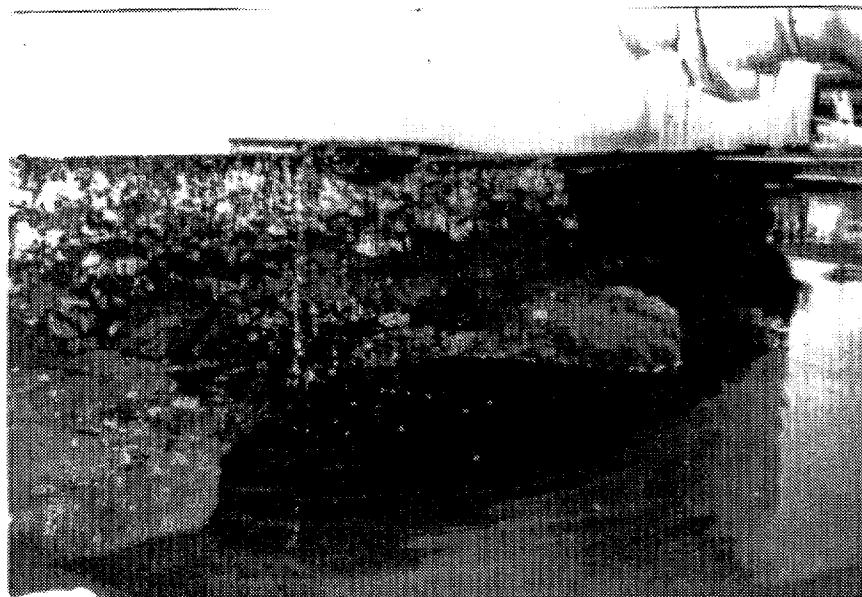


Figure 2. Damaged tank.

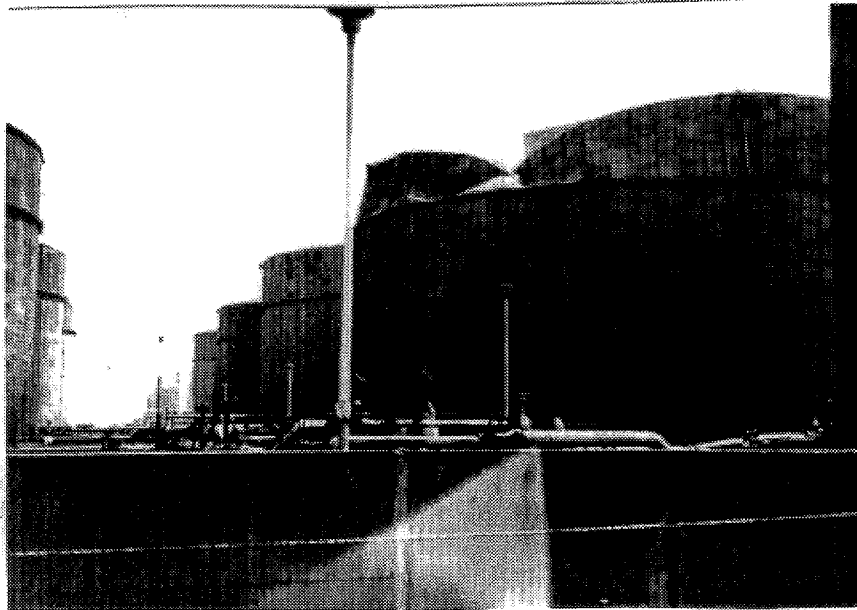


Figure 3. Imploded tanks in Sendai, Japan, from 1978 earthquake.



Figure 4. Seismic stop on boiler support structure.

*RECOMMENDATIONS FOR LIFELINE SEISMIC STANDARDS*

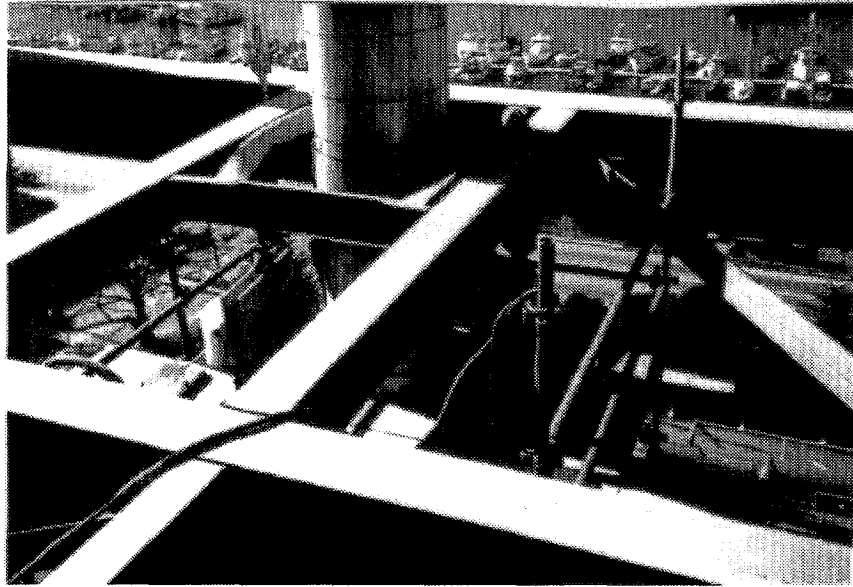


Figure 5. Damaged steam pipe restraint.

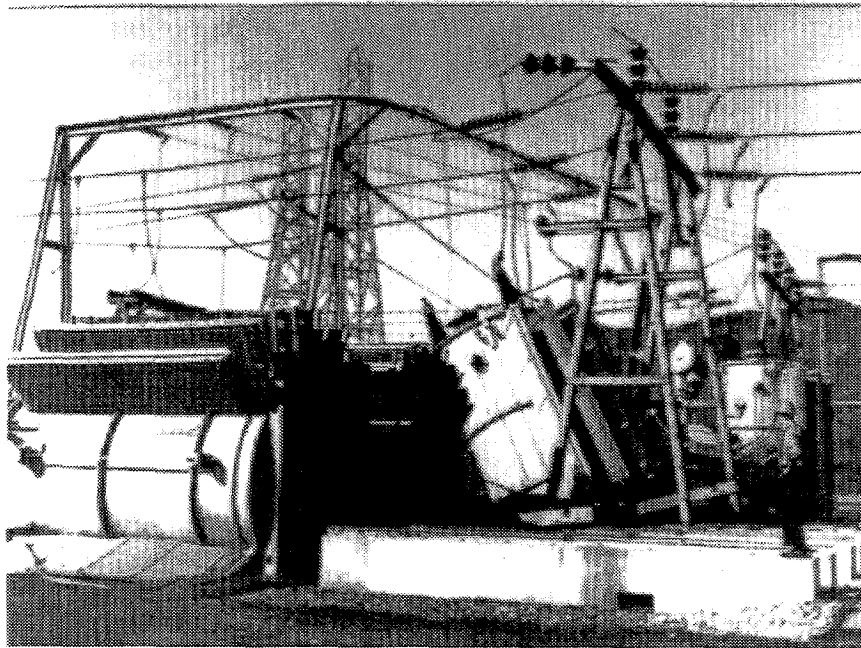


Figure 6. Transformers damaged after rolling off of rail supports in the 1971 San Fernando earthquake.

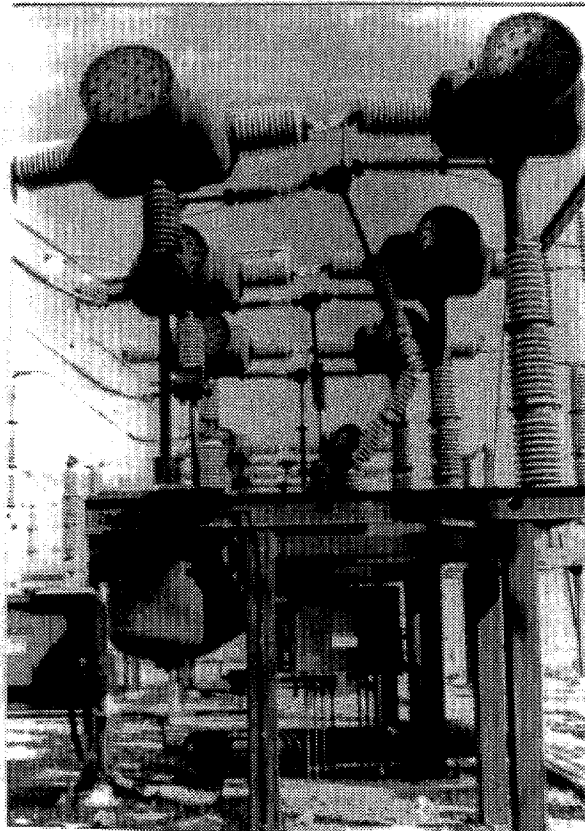


Figure 7. Live-tank circuit breaker damaged in the 1988 Tejon Ranch, California earthquake.

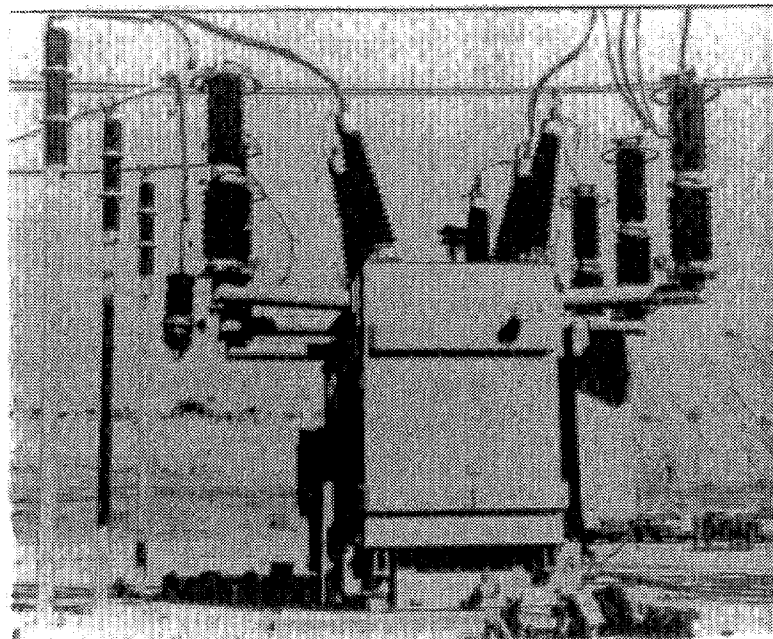


Figure 8. Unanchored transformer slides and damages lightning arrester.

*RECOMMENDATIONS FOR LIFELINE SEISMIC STANDARDS*

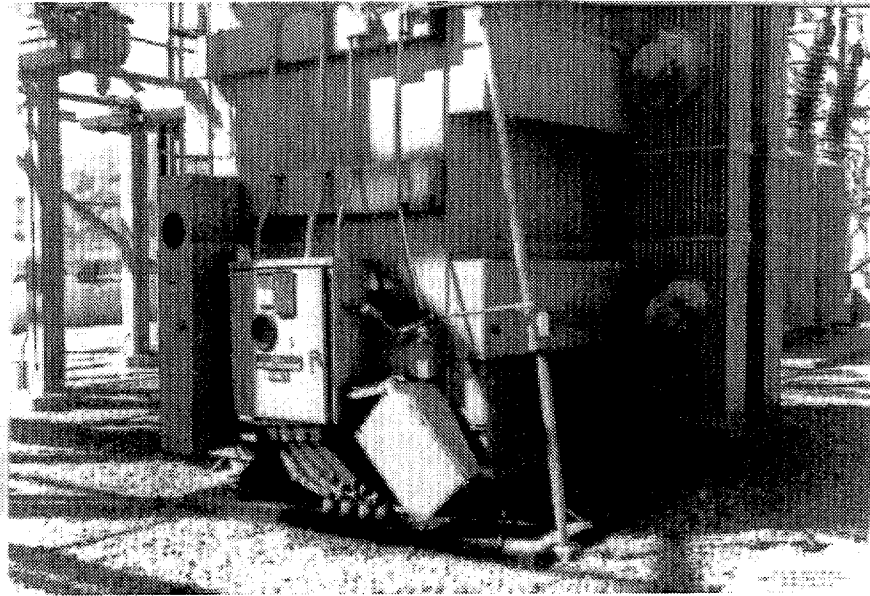


Figure 9. Damaged transformer control cables.



Figure 10. Transformer bushings damaged in 1978 Sendai, Japan, earthquake.

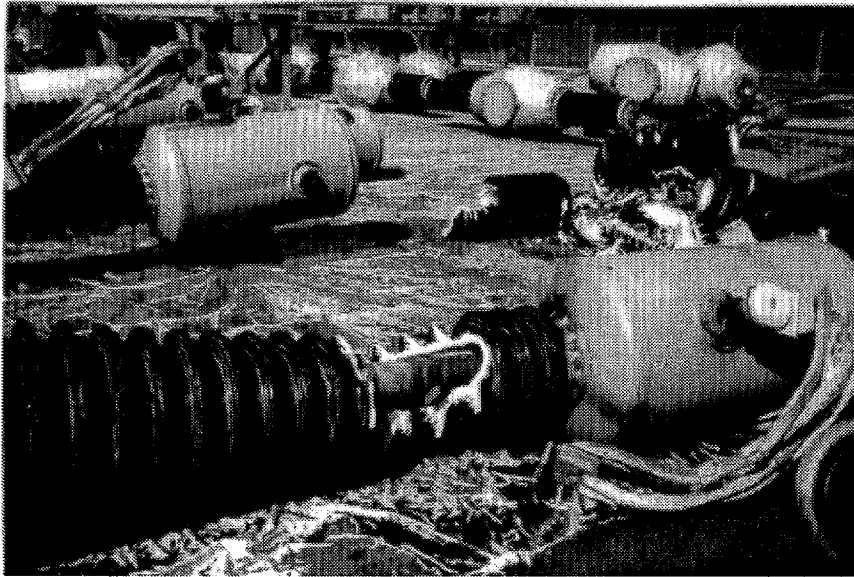


Figure 11. Current transformer damaged in the 1989 Loma Prieta earthquake.

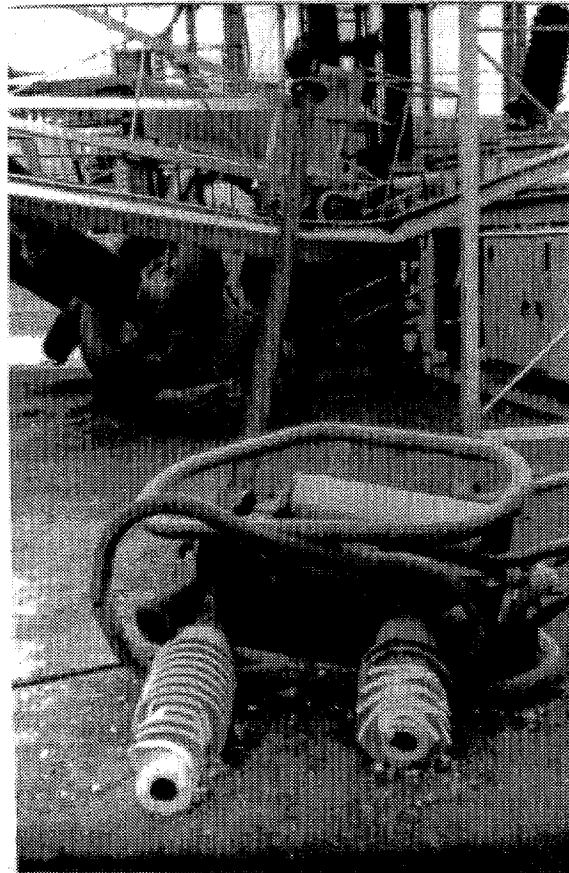


Figure 12. Disconnect switch damaged in the 1989 Loma Prieta earthquake.

*RECOMMENDATIONS FOR LIFELINE SEISMIC STANDARDS*



Figure 13. Substation control house damage.

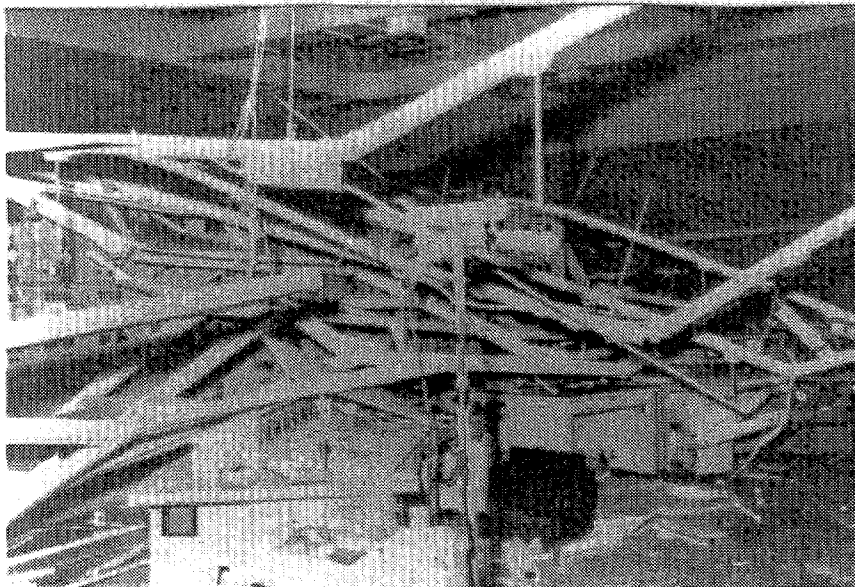


Figure 14. Control room ceiling failure in the 1971 San Fernando earthquake.





Figure 15. Fallen platform-mounted distribution transformer in the 1952 Kern County, California, earthquake.



---

## CHAPTER III: GAS AND LIQUID FUEL LIFELINES

*DOUGAS J. NYMAN*

---

### III-1. INTRODUCTION

Gas and liquid fuel systems provide energy for transportation as well as for electric power generation and the production of necessary goods and services, including heating in cold environments. In areas directly impacted by a destructive earthquake, the general public could be adversely impacted by the shutdown of oil and gas transmission lines, damage to gas distribution systems, or interruption of electric power generation due to loss of fuel supply. The lack of a fuel source can also pose a serious problem for many industrial facilities. Curtailed operation of such facilities affects not only the companies involved, but the public served by or dependent upon the company's product or service. The monetary losses and social disturbance attributable to a shutdown can be substantial, especially if the disruption in service is for a significant period of time.

The susceptibility of oil and gas pipelines (and other lifelines) to earthquake damage has been demonstrated in earthquakes in Alaska (National Academy of Sciences 1971; Richardson 1973), Parkfield (Environmental Science Services Administration 1966), Japan (Katayama et al. 1975; Kubo 1979; Miyamoto et al. 1970), San Fernando, California (National Oceanic and Atmospheric Administration 1971; Steinbrugge et al. 1971), Managua, Nicaragua (Earthquake Engineering Research Institute 1973), and Imperial Valley, California (Earthquake Engineering Research Institute 1980).

Earthquake damage to oil and gas transmission lines also may have an adverse effect on the populace hundreds of kilometers from the stricken area. For example, a number of pipelines transporting crude oil, crude oil products, and natural gas pass through the central United States within and adjacent to the New Madrid Seismic Zone in the central United States. These pipelines, which originate in producing areas, terminals, and refineries on the Gulf Coast, have been identified as being particularly vulnerable to the recurrence of a major earthquake in the New Madrid Seismic Zone (Beavers et al. 1986; Ariman et al. 1990). Significant damage to these lines could result in a serious environmental impact, safety hazard to the public, and disruption in energy supplies to the midwest and northeast. Nyman and Hall (1991) recommended that considering the cost of design retrofit versus the anticipated benefit, attention should be focused on minimizing the consequences of earthquake damage to pipelines in the New Madrid region.

#### III-1.1 Definitions

In a broad sense, gas and liquid fuel systems consist of all facilities and components that are needed for the production, transportation, and distribution of natural gas, crude oil, and crude oil products. These facilities include:

- Production wells, offshore platforms, and gathering facilities
- Transmission pipelines (natural gas, crude oil, crude oil products)
- Distribution systems (natural gas)
- Pump and compressor stations
- Terminals

## RECOMMENDATIONS FOR LIFELINE SEISMIC STANDARDS

- Tank farms (storage tanks)
- Control systems
- Fire suppression systems
- Communications
- Isolation valves
- Maintenance facilities
- Refineries

Production facilities serve as the source of the gas and liquid fuel supply and consist of wells, offshore platforms, gathering lines, and various systems needed for the separation of oil, gas, and water. Significant redundancy is inherent in production facilities due to their spatial distribution, and earthquake-related interruptions to a particular oil or gas production facility likely would have only a limited impact on customer supply. Furthermore, offshore platforms typically have a high level of seismic resistance due to their compliance with comprehensive industry standards (American Petroleum Institute 1989).

Natural gas pipeline systems are classified according to three general categories: (1) gathering, (2) transmission, and (3) distribution facilities. Liquid pipeline systems are classified according to gathering and transmission facilities; distribution is achieved principally through loading tanker trucks or rail cars at product terminals. In some cases transmission pipelines deliver liquid products directly to major customers, e.g., oil- or gas-fired electric generating stations.

As depicted in the schematic in Figure 1, a gathering system collects natural gas from production fields and delivers it to a transmission pipeline system. Transmission pipelines transport natural gas from gathering systems or storage facilities to distribution systems or other storage facilities. A schematic of a liquid pipeline system is shown in Figure 2. Transmission pipelines transport crude oil from production gathering systems and terminals to refineries or other terminal facilities. Transmission pipelines also transport products from refineries to distribution terminals or major customers.

Natural gas transmission pipelines may be virtually any size but most commonly are 0.51 m diameter or larger and operate at pressures from 1.4 MPa to 8.3 MPa. Circumferential stresses in transmission lines generally range from 20 to 72 percent of the specified minimum yield strength (SMYS) of the pipe steel.

Natural gas distribution pipelines usually range in diameter from 0.05 m to 0.20 m to branch lines or manifolds that discharge into storage tanks. Circumferential stresses in transmission pipelines are limited to 72 percent of SMYS.

Pump and compressor stations, terminals, storage tanks, valves, control systems, and communications are essential for the safe, continuous operation of pipeline systems. Maintenance facilities usually serve an important role in a pipeline company's response to contingency situations. Refineries serve as the terminal ends for crude oil pipelines and as sources for liquid product lines. In some areas the impact of earthquake-related damage to refinery operations can be partially offset by inventory on hand and/or spare capacity in neighboring refineries.

### III-1.2 Scope

The plan for the development of seismic standards for gas and liquid fuel systems encompasses most major facilities and components used in the transportation and distribution of natural gas, crude oil, and crude oil products. These include the pipelines, pump stations, compressor

## *GAS AND LIQUID FUEL LIFELINES*

stations, terminals, storage tanks, valves, communications, control systems, and maintenance facilities. Refineries, which serve as the downstream terminals for crude oil transmission lines and the source for product lines, are also included.

Four seismic standards are proposed for gas and liquid fuel systems as follows:

- Transmission lines
- Distribution systems
- Storage tanks, liquid fuel, and liquefied natural gas (LNG)
- Refineries

It is noted that some repetition of topic areas will exist among the standards at the component level. For example, buried pipelines are common to the standards for transmission lines and distribution systems; similarly, control systems are common to transmission, distribution, and refineries.

### **III-1.3 Philosophy**

The goal of seismic standards for a gas and liquid fuel system is to achieve a balanced design to withstand the effects of earthquakes and other loadings that is both safe and economically feasible. Seismic standards should take account of the nature and importance of the project, cost implications, and risk assessment centering around such items as public safety, loss of product or service, and damage to the environment. The standards should address, to the degree possible, the concepts that would lead to a balanced seismic design, a design in which:

- The design criteria for a given system are consistent for the various earthquake hazards as well as other natural hazards.
- The design criteria are selected so that the risk of damage and the associated failure consequences are consistent with hazard and functional considerations such that no components are over- or underdesigned.

The concept of a balanced design may be difficult to achieve because many of the parameters necessary for making rational decisions are either unknown or not well defined. The goal of a balanced design is for all major components of a lifeline system to have failure risks and consequences that are consistent with system performance objectives. In some cases, the solution to a severe seismic load condition (such as a fault crossing) may be to do nothing special with regard to design, but rather to take mitigative steps to ensure that pipeline failures, if they occur, can be repaired quickly with minimal consequences.

#### **III-1.3.1 Policy**

The single most important issue for earthquake risk mitigation for gas and liquid fuel systems relates to public policy, namely the cost of achieving a particular level of seismic resistance versus the benefit that would be derived. Costs and benefits are difficult to assess due to the limited knowledge of earthquake recurrence (especially east of the Rocky Mountains), the uncertainty involved in projecting pipeline damage, and the quantification of the impact of pipeline service interruptions. The costs of earthquake protection will, of course, be borne by the consumer, and in the absence of earthquake regulatory requirements, pipeline companies have little or no financial incentive to make improvements. Some pipeline companies might elect to make certain improvements to protect their own assets and limit their liability, but their incentives may be

## RECOMMENDATIONS FOR LIFELINE SEISMIC STANDARDS

substantially different than those of the public.

The consequences of pipeline rupture differ for gas and liquid fuel pipelines. The principal concerns for natural gas transmission and distribution pipelines are explosion and fire, which could be a threat to public safety, and loss of service to customers. Environmental concerns are virtually nonexistent because the release of natural gas to the atmosphere is generally inconsequential.

For crude oil or product pipelines the explosion and fire hazard is diminished considerably, but the potential release of crude oil or liquid products into watersheds and groundwater and contamination of water supplies are serious environmental and health issues. The loss of service to customers is also an important concern, but secondary to the environmental threat.

Pipelines are subject to risk of damage from a number of causes totally unrelated to earthquakes. These include corrosion, outside force, material failure, and construction defects. An analysis of reportable incidents for natural gas transmission and gathering lines (Jones et al. 1986) indicates that approximately 685 failures classified as propagating ruptures, punctures, blowouts, or tears occurred over a 14.5-year period in natural gas pipelines totalling about 480,000 kilometers in length. This averages approximately  $1.0 \times 10^{-4}$  failures per kilometer of pipeline per year. For a postulated 50-year service life, this statistic relates to approximately  $5 \times 10^{-3}$  failures per kilometer or one failure per 200 kilometers (Nyman and Hall 1991).

An earthquake with an estimated recurrence interval of 500 years would have to produce about 10 such pipeline failures over a 200 kilometer route to be comparable to the operational statistic, and this failure rate probably represents an upper bound for most welded steel pipelines. Admittedly, the statistics are crude, but they do indicate an order of magnitude of the relative threat posed by strong earthquakes. It seems clear that the expenditure of large sums of money to increase seismic resistance must be tempered by recognition of the hazards associated with day-to-day operations.

It is acknowledged that earthquake damage will occur simultaneously in multiple locations for a number of pipelines as opposed to being distributed randomly (i.e., one at a time) through the operating life of each individual pipeline. Coupled with widespread damage to the general infrastructure, the sudden loss of a major portion of a region's energy supply could have a significant adverse impact on the population.

Direct mitigation of potential damage to pipelines probably would involve reconstruction or rerouting of pipeline segments in areas prone to experience large ground movements. Changes could be extensive and, unless made in conjunction with the scheduled replacement of corroded pipe, would be difficult to justify on a cost-benefit basis. Furthermore, retrofit concepts would be unproven because of the limited experience with welded steel pipelines in zones of large ground movement. Therefore, from a practical view, extensive changes to pipeline construction mode or alignment are not likely to be cost-effective.

Considering the cost of improving seismic resistance and the relatively low likelihood of large earthquakes during the operational life of a pipeline, it seems more reasonable to focus attention on minimizing the consequences of destructive earthquakes. In particular, the environmental and safety impact of extensive pipeline damage can be reduced through improved line-break isolation, earthquake contingency plans, repair plans, and seismic retrofit of pump and compressor stations, including seismic hardening of control systems and communications.

### **III-1.3.2 System Design**

Gas and liquid fuel systems generally are spread over a large geographical region and encounter a wide variety of seismic hazards and soil conditions as illustrated in Figure 3. A number of subsystems are located along a pipeline transmission system, including, for example, tank farms, valves, pump and compressor stations, monitoring stations, control centers, communication systems, and special port or terminal facilities at either end. Each of these subsystems has its own unique seismic design requirements and in some respects, because of the complex assemblage of elements, may be more vulnerable to earthquake damage than the pipeline itself.

The pipeline, as well as pumps, compressors, control systems, and other components that are critical for continued operation and system control, normally should be designed to survive a major earthquake with almost no damage. However, structures housing this equipment, storage buildings, and other structures not directly affecting the operation of a pipeline facility could experience large inelastic deformations, as long as damage to the structure does not compromise safety or the operation of critical components of the facility. Allowable amounts of damage may vary according to the nature and importance of the components or structures being considered. The design of nonessential facility structures and components is usually based on an economic decision of the owner (and in accordance with appropriate building codes) with consideration for personnel safety.

## **III-2. STATE OF THE ART**

The state of the art of earthquake engineering for gas and liquid fuel systems has evolved rapidly since the 1971 San Fernando earthquake, and it has been practiced to varying degrees on a number of new projects and to a limited extent in the upgrading of older systems. Research investigations and analysis methodology have been documented in a myriad of technical reports and papers, and are summarized succinctly in a state-of-the-art review by O'Rourke et al. (1985). The development of concepts and analytical approaches is largely complete, except for several research needs that have been identified (Hall 1986; Nyman and Kennedy 1986; Nyman 1986; O'Rourke 1986). A comprehensive guideline prepared by the ASCE Committee on gas and liquid fuel lifelines (ASCE 1984) documented the state of practice for seismic design and provided guidance for the seismic design of most major components of oil and gas pipeline systems. Codes and standards that address seismic resistance and earthquake preparedness for gas and liquid fuel systems do not exist, but practice in this area has advanced to the point that standards development could commence.

A detailed account of seismic hazards for gas and liquid fuel systems, current practice, the current state of knowledge, and research needs are presented in the next sections.

### **III-2.1 Seismic Hazards For Gas And Liquid Fuel Systems**

Gas and liquid fuel transmission and distribution systems traverse large geographical areas and, thus, may encounter a wide variety of seismic hazards and soil conditions. The major seismic hazards that can significantly affect a gas and liquid fuel system are:

- Fault movement
- Liquefaction (lateral spreading, flow slides, loss of support, buoyancy)
- Landslides
- Ground shaking
- Tsunamis or seiches

## RECOMMENDATIONS FOR LIFELINE SEISMIC STANDARDS

The various components of gas and liquid fuel systems are affected by seismic hazards in different ways. For example, ground shaking is a major concern for above-ground components, such as buildings and storage tanks, but is of little concern for buried pipelines. Faulting, liquefaction, and landslide hazards, on the other hand, can often be eliminated for above-ground structures by careful siting, but cannot always be avoided for buried pipelines. In coastal areas, tsunamis or seiches are potential hazards for marine terminal facilities.

Other potential seismic hazards that are less likely to damage welded steel pipelines include seismic wave propagation and subsidence.

The effects of seismic hazards on gas and liquid fuel systems can be subdivided according to three general classes of facilities: buried pipelines, storage tanks, and plant facilities and equipment. A general characterization of the seismic hazards for these component classes is provided in the next sections.

### III-2.1.1 Ground Movement Effects On Pipelines

Oil and gas pipelines are typically buried with a depth of soil cover of 0.75 m or more. Burial tends to make a pipeline more susceptible to large permanent ground distortions, such as fault movement, landslide, or liquefaction (loss of support and lateral spreading). With respect to a given pipeline route these effects generally are sporadic, depending on local soil, groundwater, and topographic conditions. The nature of the ground movements are not well defined and generally can occur at any point within an area of potential movement.

Seismic wave propagation should not have a serious effect on buried welded pipelines in good condition. Exceptions include transitions between very stiff and very soft soils, penetration into valve boxes, and locations at or near pump stations, T-connections, pipe fittings, and valves. Pipelines weakened by corrosion, compression couplings, and old cast-iron pipe with bell and spigot joints may also be vulnerable to seismic wave propagation.

#### III-2.1.1.1 Fault Movements

Faulting is the deformation associated with the relative displacement of adjacent parts of the earth's crust. Fault displacements can occur suddenly during an earthquake or accumulate gradually over long periods of time.

Faults are classified on the basis of their direction of movement or slip with respect to the ground surface. The various types or classifications of fault movement are illustrated schematically in Figure 4. For example, a strike-slip fault is one in which the predominant component of ground movement is a horizontal displacement. If the movement of one side of the fault when viewed from the other side is to the right, the fault is called a right lateral strike-slip fault. When the movement is to the left, the fault is called a left lateral strike-slip fault. Normal-slip and reverse-slip faults are those in which the overlying side moves downward and upward, respectively, in relation to the underlying side of the fault. In many cases faults exhibit a combination of strike-slip and normal or reverse-slip movements.

Faulting that results in surface rupture is an important consideration for buried pipelines, because pipelines crossing fault zones must deform longitudinally and in flexure to accommodate ground surface offsets. The effect of a right lateral strike-slip movement on a buried pipeline is illustrated in Figure 5. For some faults the maximum credible surface movements can be as large as 9 m for



strike-slip faults and 4.6 m for normal-slip faults. In some cases ground movements for a particular fault may occur over a number of closely-spaced parallel fault traces or splays within a fault zone, and consideration must be given to the total as well as the individual movements within the zone.

### **III-2.1.1.2 Liquefaction**

Liquefaction is the transformation of a saturated cohesionless soil from a solid to a liquid state as a result of increased pore-water pressure and concomitant loss of shear strength. Loss of shear strength gives rise to bearing failures and large deformations in surface structures founded on liquefied soil. Liquefaction often leads to the formation of sand boils, mud volcanoes, fissures, and other channels through which water and sediments are ejected. These ejections cause volume loss resulting in sharp differential settlement even though no significant lateral movement occurred.

When the soil around a buried pipeline liquefies, buoyancy forces are exerted on pipelines whose weight with contents is less than the weight of displaced water. Vertical movement must be resisted by anchors and/or the drag forces imposed by the liquefied soil as the pipeline begins to elevate (Kennedy et al. 1977). Buoyancy effects are probably of greatest concern in areas such as flood plains and estuaries where widespread liquefaction could take place in a large earthquake. The amount of pipe displacement will depend upon the size of the liquefied region, duration of liquefaction, depth of burial, buoyancy weight of the pipeline, and the drag force of the liquefied soil resisting pipe movement. Depending on the soil conditions, vertical displacements of 3 to 5 m are possible.

Lateral spreads involve the horizontal movement of competent surficial soils due to liquefaction of an underlying deposit (see Figure 6). Lateral spreads can be especially destructive to buried pipelines, albeit the degree of damage depends on the magnitude and extent of ground movement and the configuration of the pipeline. Past experience with earthquakes indicates that loose cohesionless fills near waterfronts, toe areas of alluvial fans and deltas, active floodplains, river channels, and saturated colluvial deposits are settings more particularly vulnerable to liquefaction.

Maximum lateral-spread ground distortions are generally concentrated along slide margins where movements tend to replicate strike-slip and normal faulting. At the base of lateral spreads, large compressive strains and reverse-slip movements develop (ASCE 1984). Of particular concern are river crossings where liquefaction leads to tensile strains at the upper margins of spreads and compressive strains where the spreads converge at the river.

Pipelines buried in somewhat steeper slopes (greater than 3° to 5°) in liquefiable soil may be subject to flow failure, in which there is a sudden catastrophic loss of soil strength with ensuing large displacements.

## RECOMMENDATIONS FOR LIFELINE SEISMIC STANDARDS

### III-2.1.1.3 Landslides

Landslides are mass movements of the ground that can be triggered by seismic shaking. The most significant landslide hazards that can affect buried pipelines are slumps, shallow slides, and deep slides.

Slumps and shallow slides are caused primarily by inertial forces, but are often assisted by densification of loose soil or liquefaction of underlying sediments. These movements occur mostly along the margins of embankments, cut-and-fill slopes, and slopes with relatively shallow cover in hilly or mountainous terrain.

Deep slides involving significant components of translation and rotation of a soil mass often develop catastrophically and affect large areas. A landslide frequently causes underthrusting in soils near the base of its slope so that substantial compression and bending may be transferred to pipelines located there.

Landslides are not generally a significant hazard for new pipelines since they usually can be avoided through careful route selection. However, pipelines constructed prior to the 1970s may have been routed without regard for landslides caused by earthquake shaking. As illustrated in Figure 7, the effect of a landslide on a pipeline would be to load the line transversely as a cable with local fault-like soil distortions at the boundaries of the slide.

### III-2.1.2 Storage Tanks

Liquid storage tanks and liquefied natural gas (LNG) tanks are important components of liquid fuel systems. The failure of storage tanks could seriously limit or curtail the operation of a pipeline, not to mention the safety hazard associated with the release of flammable or toxic contents.

The vulnerability of unanchored liquid storage tanks to earthquake ground motion has been demonstrated in almost every major earthquake. In regions of intense ground shaking many tanks have been severely damaged and some have failed with disastrous consequences. For example, the fires that followed the 1964 earthquake in Niigata, Japan, caused extensive damage to two oil refineries. The failure of oil storage tanks in the 1978 earthquake in Sendai, Japan, polluted local waterways, and the 1964 Prince William Sound earthquake in Alaska caused the failure of numerous oil storage tanks and fires.

Liquid storage tanks employed in pipeline systems generally vary from 10 to 75 m in diameter with heights that are nearly always less than the diameter. Damage that has occurred in past earthquakes has usually consisted of breakage at piping connections because of tank settling, sliding, or rocking or formation of a circumferential compression buckle near the base of the tank (see Figure 8). In some cases, rupture of the tank shell has occurred, but usually loss of contents can be attributed to failure of piping attachments to the tank wall. Damage to floating and fixed roofs has also occurred due to fluid sloshing, but this can be expected because of their intentional fragile design.

LNG tanks have design features similar to oil storage tanks, except for differences in material specification, the use of insulation, and slight tank pressurization. LNG tanks are typically double-wall, single-containment systems with the inner shell containing the liquid and the outer shell serving mainly to contain the internal operating pressure (0.007 to 0.014 MPa) and the insulation material surrounding the inner shell. Secondary containment is provided by a

surrounding earthen berm, concrete dike, partial ingrounding, etc. Typically, tanks are supported by a continuous, reinforced concrete ring beam or a concrete mat. In regions of high seismicity, economical design requires the use of anchored tanks with low H/R ratios to enable them to resist overturning forces.

### **III-2.1.3 Plant Facilities And Equipment**

Gas and liquid fuel systems utilize various types of plant facilities in the processing, transportation, and delivery of natural gas, crude oil, and crude oil products. These facilities generally include industrial buildings, piping and pipe supports, vessels, mechanical and electrical equipment, control systems, instrumentation, and communications.

At most plant facilities structural design has been performed in accordance with governing building codes such as the Uniform Building Code (UBC), which is published every three years by the International Conference of Building Officials. Since 1988 the UBC has been generally applicable to industrial facilities. The code lacks specific guidance, however, in the classification of structures and components according to performance objectives and relative importance.

Control systems and communications are among the most vulnerable components of gas and liquid fuel systems. These systems provide critical monitoring and control of pipeline systems, refineries, and terminals, and their complexity is consistent with throughput and facility size. Examples of critical components include monitoring instrumentation, communication equipment, computer hardware, remote valve auxiliary equipment, emergency power systems, and uninterruptible power supplies. At most facilities, such components have been procured, configured, and installed with no special regard for seismic resistance. In fact, outside of California, anchorage of such critical items will often be inadequate or nonexistent.

Heavy mechanical equipment (pumps, compressors, etc.) is usually adequately anchored because of the necessity to prevent movement or vibration under operational loads.

A related area of seismic vulnerability at gas and liquid fuel facilities is the potential for nonstructural damage due to sliding and overturning of furnishings (see Figure 9), storage racks, and unanchored equipment or falling of HVAC, conduit, cable trays, and suspended ceilings. Examples of such occurrences are well documented for the 1964 Alaska earthquake and the 1971 San Fernando earthquake. The general concern is that equipment or furnishings, which themselves may not be particularly important, should not be allowed to move or overturn such that critical components, in proximity, are damaged or otherwise rendered nonfunctional.

### **III-2.2 Current Practice**

The minimum standards for gas and liquid fuel systems are defined in Title 49 of the Code of Federal Regulations (CFR), Part 192 and Part 195 (U.S. Department of Transportation 1991a, 1991c, respectively). The Federal regulations for transportation of gas and liquids are based, respectively, on ANSI Standards B31.8 and B31.4, which have been developed and maintained by technical committees of the American Society of Mechanical Engineers (ASME). Except for a general statement of the need to design liquid pipelines (ANSI B31.4 and 49 CFR 195) for the effects of earthquake-induced external loads, the ANSI standards and the CFR do not prescribe seismic design requirements. These standards and regulations represent minimum requirements for design, construction, and operation; many companies exceed the requirements stipulated by the ANSI standards and the CFR for safety.

## RECOMMENDATIONS FOR LIFELINE SEISMIC STANDARDS

The intent of government regulations is generally that of ensuring a safe facility, which usually implies that the facility should withstand the effects of any identified hazards to be expected without endangering facility personnel or the general public. For pipeline systems in environmentally sensitive areas, the regulatory role may be expanded to include mitigation of damage to the environment.

The development of seismic design criteria first became of real interest to the petroleum industry following damage to oil storage facilities during the 1933 Long Beach, California, earthquake. Until that time, seismic design provisions consisted largely of assigning a small percentage of the total weight of the structure to act as a pseudostatic lateral load. Thereafter, development of seismic design criteria for critical facilities progressed relatively slowly, until the late 1950s and early 1960s when the construction of nuclear power plants dictated the need for developing and employing modern earthquake engineering principles and practices. This action played a major role in the ensuing development and application of modern earthquake engineering criteria to critical facilities of many kinds.

One of the first major applications of seismic design criteria to an oil pipeline system was the Trans-Alaska Pipeline and its associated facilities. Since that time, improved seismic design approaches have been utilized on the design and construction of a number of new transmission pipeline projects, and seismic vulnerability assessments have been made for a number of existing transmission pipelines and gas distribution systems for the purpose of upgrading and contingency planning.

A guideline on seismic design of most major components of oil and gas pipeline systems was prepared by the ASCE Committee on Gas and Liquid Fuel Lifelines in the early 1980s (ASCE 1984). The document was intended primarily for engineers engaged in the design of oil and gas pipelines and facilities; however, it also provides guidance to pipeline company management, regulatory groups, disaster recovery agencies, and insurance companies. The document is a compendium of knowledge on the practice of earthquake engineering for oil and gas pipeline systems, but is not a design manual, code, or standard.

Most new pipeline systems, especially those in regions of high seismic exposure, are now subject to the requirements of Federal and State governmental regulatory agencies for design to mitigate geologic hazards. The Federal Energy Regulatory Commission (FERC) and the Department of Interior regulate interstate natural gas and oil transmission systems, respectively, while State public utility commissions regulate intrastate pipelines. There is no regulation or guiding policy for prescribing seismic mitigation measures; rather it seems that seismic issues are addressed more or less independently for each project.

Current practice for the seismic design of major pipeline systems (new construction) follows the precedent set by the nuclear industry in that two levels of earthquake hazard are selected for design. The low-level event generally has a return period of 50 to 100 years and is referred to herein as the *probable design earthquake* (PDE). As a requirement self-imposed by the owner, the system is designed to withstand the PDE without significant damage and with minimal interruption of operational functions. The higher-level event is generally one that has a return period of 200 to 500 years or more, depending upon the nature of the facility. This event is referred to herein as the *contingency design earthquake* (CDE) and is an event for which the major regulatory requirement is that the system not pose a threat to safety or to the environment, although significant structural damage could occur. The amount of permissible damage varies according to the type of structure or component and its function.

Pipeline companies have established operating procedures to handle many types of general contingency situations. From the company's point of view, contingencies resulting from earthquake damage are not altogether different from other contingencies, such as those resulting from improper excavation, storms, or fires, except that following earthquakes many such contingencies may occur simultaneously. In the event of a severe earthquake, the ability to respond to contingency situations or to restore the line to operation would be seriously impaired by the general devastation to the infrastructure in the area, particularly the possible loss of commercial power and communications, and the damage to roads and highways. Except for some of the West Coast utilities, it is doubtful that many pipeline operators have adequately accounted for the impact of multiple pipeline contingencies and general infrastructure damage on the execution of their contingency response plans.

### **III-2.3 Current State Of Knowledge**

Except for API Standard 650 for liquid storage tanks and various standards and regulations for LNG tanks, e.g., 49 CFR 193 (U.S. Department of Transportation 1991b), no codes or standards are directly applicable to the seismic design of gas and liquid fuel systems. The ASCE (1984) guidelines partially fill this void by providing a comprehensive and perceptive summary of accepted practice. The guidelines address the identification and quantification of seismic hazards, seismic design criteria, ground movement effects on buried pipelines, seismic response of storage tanks, seismic response analysis of facilities, and operations and maintenance considerations. The guidelines also provide the rationale for establishing levels of acceptable risk regarding the design, construction, operation, maintenance, and upgrading of systems and components common to pipeline systems.

Since the publication of the ASCE guidelines, a number of studies have advanced the knowledge of seismic hazard mitigation for gas and liquid fuel systems. Among these are the validation of the ATC 3-06 provisions for seismic design of buildings (Applied Technology Council 1978; FEMA 1986), quantification of liquefaction hazards by Youd and others (Youd and Perkins 1987; Youd et al. 1989), and detailed studies of the effects of lateral spreading on buried pipelines (O'Rourke and Lane 1989).

A commentary on existing knowledge of seismic design of gas and liquid fuel systems is presented in the sections that follow.

#### **III-2.3.1 Pipeline Design For Ground Movement Effects**

The past performance of large-diameter oil and gas transmission pipelines subjected to earthquakes generally has been satisfactory. Modern pipelines are made of ductile steel and welded with full-penetration welds, resulting in a structure with substantial inherent ductility. Because of this ductile behavior, it is expected that buried pipelines generally can withstand considerable soil distortion or differential displacement in cohesive or granular soils (except for narrow rock trenches or frozen soil) without rupture.

Buried oil and gas pipelines generally have not been affected by seismic wave propagation. This is borne out by the lack of a single reported case of failure of ductile, full-penetration welded oil or gas pipeline attributable to wave propagation alone. Investigation of cases in which pipelines were thought to have been damaged by ground shaking have concluded that corrosion combined with surges in line pressure during the earthquake was the main reason for damage (Isenberg 1978).

## RECOMMENDATIONS FOR LIFELINE SEISMIC STANDARDS

Seismic wave propagation damage to a buried, continuous welded steel water pipeline during the 1985 Michoacan (Mexico City) earthquake has been reported by O'Rourke (1988). The pipeline was constructed of 1.07 m x 8 mm wall API X42 pipe, which generally is thinner than most pipe in service on oil and gas pipelines. The reported damage was compressive wrinkling at intervals of approximately 150 m and occurred in soft clay deposits. The pipeline was influenced by unusual seismic and geologic conditions. Because of the long distance separating Mexico City and the earthquake epicenter (nearly 400 kilometers), the predominant period of incoming waves was a relatively high 2 to 3 seconds. Site amplification contributed to a high peak particle velocity, measured at 35 cm/sec, and the soft lake sediments were characterized by a wave propagation velocity as low as 40 to 100 m/sec. The combination of high-particle and low-wave propagation velocities would have promoted high ground strain, and the long period would have promoted a relatively large development length for mobilizing shear resistance between the pipe and adjoining soil. Although these observations indicate that traveling ground waves can damage modern steel pipelines, the conditions which promote such damage are rare and unlikely to be a major source of damage to continuous welded steel pipelines in future earthquakes.

For above-ground pipelines or piping segments, ruptures most likely result from failure of support structures, from failure of pipeline attachments to support structures, or from large relative support movements. There does not appear to be a case of an above-ground pipeline or piping segment rupturing from the inertial effects of ground shaking.

Pipeline steels generally can accommodate average tensile strains on the order of 2 to 5 percent without rupture with local strain concentrations of 15 percent or more. Careful quality control over pipeline manufacture and welding is a necessity for achieving the desired performance under these strains. In compression, local instabilities such as wrinkling can develop at strains much less than the allowable tensile limits, on the order of 15 to 30 percent of the ratio of wall thickness to radius of the pipeline (Wilson and Newmark 1933), which is typically in the range of 0.3 percent to 0.6 percent strain for most large diameter pipe. An example of compressive pipe wrinkling that occurred in a 0.41 m gas pipeline during the 1971 San Fernando earthquake is shown in Figure 10.

Flexural strains of the same order of magnitude as tensile strains will generally not result in rupture conditions, although consideration should be given to the potential for wrinkling due to compressive bending strains. Tests of large diameter X-60 pipe with a diameter to thickness ratio of about 80 (Bouwkamp and Stephen 1973) demonstrate that large diameter pipe under pressure can mobilize significant additional flexural strain after the onset of wrinkling (up to 20 times the curvature associated with initial wrinkling).

Increasing the pipe wall thickness will increase the stress/strain level associated with the initiation of wrinkling. However, postbuckling behavior of the pipeline is important insofar as the pipeline is able to experience significant wrinkling in the pipe wall without rupture. It is possible that thinner wall pipe would have better capability to hold pressure as wrinkling deformation develops, because the localized strains at the wrinkle section should be less than for thicker wall pipe.

### III-2.3.1.1 Fault Movement

Fault movement is one of the most severe seismic loadings that can affect a pipeline. For example, major strike-slip faults may require design for movements as large as 9.1 m strike-slip and 1.5 m normal-slip. For fault-crossing design, it is important to cross the fault in an orientation that will avoid putting the pipeline in compression. Optimum fault-crossing angles

## GAS AND LIQUID FUEL LIFELINES

will depend upon the dip of the fault plane and the expected type of movement.

Pipelines resist deformations induced by fault movements through development of longitudinal friction forces between the pipeline and the surrounding soil and resistance of the soil to lateral (horizontal or vertical) pipeline displacement. The total friction resistance is proportional to the pipeline circumference while the lateral resistance is proportional to diameter and depth of burial (Audibert and Nyman 1977). The soil resistance and, hence, pipeline strains decrease with the distance away from the fault until at some point there is no relative pipeline-soil movement and the pipeline can be assumed anchored.

As a general rule, the further away the points of virtual anchorage are from the fault, the longer the length of pipeline available to conform to the fault movement and the lower the levels of strain. Thus, fault movement capacity can be maximized by minimizing the longitudinal, lateral, and uplift resistance between the surrounding soil and the pipe. The most practical means for achieving minimum soil restraint is to bury the pipeline in a shallow trench with a loose granular backfill. As depicted in Figure 11, the trench walls should be sloped at an angle of about 30° for strike-slip faults and about 60° for normal or reverse faults. This trench geometry will mobilize soil movement (failure) within the backfill material rather than in the higher strength undisturbed soil outside the trench. Sharp bends, tees, etc., also will have a tendency to anchor the pipeline against axial movement and should be avoided within a fault-crossing zone.

Analyses of pipelines subject to permanent soil displacements have followed established approximate calculation procedures (Newmark and Hall 1975; Kennedy et al. 1977), but computer modeling methods have also been used. Both of these methods should have the capability of accounting for inelastic material behavior of the pipe, nonlinear soil restraint, and large displacements.

Oil and gas pipelines can withstand severe fault motions without rupture provided the movement is resisted in tension and there is sufficient ductility to allow substantial tensile straining. Pipeline ductility should be maximized in fault-crossing regions. Increases in ductility (ratio of rupture strain to elastic limit strain) and increases in the ratio of ultimate strength to yield strength are both more important than increases in the yield strength. Abrupt changes in wall thickness or other strain concentrators should be avoided within fault zones. Since there is considerable uncertainty involved in the design of pipelines to withstand faulting, contingency plans should be developed at major fault crossings to contain spills if they occur and to provide for pipeline repair as necessary.

Alignments that would place the pipeline in compression are avoided to the extent possible because local wrinkling of the pipe wall is the failure limit state for compression and will occur at compressive strains substantially less than the tensile strain levels associated with rupture. (Once wrinkling is initiated, further compressive shortening of the pipeline would be expected to concentrate at the location of the wrinkle.)

In certain cases, fault movements could be so large or adversely oriented that design mitigation would not be practical. For example, to withstand specified fault movements, it might be necessary to place a pipeline in a flexible, above-ground configuration, in which case the hazards presented by exposure to third-party damage could exceed the probability of fault slip, not to mention a significant increase in cost. A more rational approach would be to assess the risk of fault-related damage and compare the result with the accepted risks inherent to other natural and man-made hazards for the project (Anderson 1984). On that basis the damage risk for some fault crossings may be demonstrated to be acceptable, and special mitigation measures unnecessary.

## RECOMMENDATIONS FOR LIFELINE SEISMIC STANDARDS

### III-2.3.1.2 Liquefaction

Pipelines buried in liquefaction-susceptible soils can be subjected to lateral spread movements and flow slides or experience loss of support conditions (buoyancy or settlement depending on net pipeline weight). Investigations of the effects of this type of movement can generally be handled with the same analytical techniques used for fault crossings, although the differential movements are not as severe. The amount of pipeline displacement will depend upon the size of the liquefied region or flow movement, depth of burial, net weight of the pipeline, and the drag force of the liquefied soil acting upon the pipeline or shear strength of the soils loading and restraining the pipeline (ASCE 1984). These quantities are generally not well known, so a great deal of uncertainty exists in estimates of pipeline displacement.

Lateral spreading and flow slides are potentially the most damaging liquefaction-related hazard for buried pipelines. The most direct means of mitigating spreading and flow movements is to improve the soils around the pipeline so as to retard lateral soil movement. For shallow liquefiable deposits, soil improvement could be accomplished by soil densification along the right-of-way. For deeper deposits, stabilized soil buttresses could be constructed at discrete points along the pipeline to force lateral-spread or flow-slide movements away from the pipeline alignment. Other options for mitigation of the effects of lateral movements include placing the pipeline below the lowest depth of liquefiable soil, e.g., drilled crossings beneath rivers, or changing the orientation or location of the pipeline relative to the zone of potential deformation. If a pipeline is buoyant, vertical displacements of 3 to 4.5 m are possible in liquefiable deposits. Shallow burial can limit upward movements since the pipeline will generally lift no more than 30 percent of its diameter out of the ground. Encasing the pipeline in concrete will help reduce buoyancy effects, but the increased diameter will increase lateral drag forces on the pipeline (if a flow condition is expected). Anchorage of the pipeline to prevent uplift is another possible solution and can be accomplished with anchors spaced as much as 150 m apart (Kennedy et al. 1977).

### III-2.3.1.3 Landslides

In many instances potential landslide areas can be avoided through careful route selection. However, at river and stream crossings, the combination of steep banks underlain by loose sand may be unavoidable. Such situations can be analyzed in a manner similar to that for fault crossings (provided the movement is not catastrophic in size). Alternatively, the slide zone can sometimes be avoided by deep burial below the expected limits of the sliding soil mass.

### III-2.3.2 Storage Tanks

API Standard 650 provides a generally adequate approach to the seismic design of liquid storage tanks. The code methods are based upon the rigid tank model developed by Housner (1957). This model assumes the tank walls to be rigid and the tank to be fixed at its base. In reality, nearly all liquid storage tanks are quite flexible and unanchored. Improved methods that require an estimate of the tank's natural frequency and a design spectral acceleration are available. However, the API method is sufficiently conservative if spectral acceleration is used in lieu of ground acceleration. The effects of vertical ground motions are typically accounted for by increasing the hydrostatic hoop stresses by applying a constant vertical acceleration to the fluid mass in addition to that from gravity.

Existing standards and regulations applicable to LNG storage tanks include the industry standards



NFPA 59A (National Fire Protection Association, Inc., 1975), API Standard 620 (1990), and API Standard 650 (1988); the Federal regulation 49 CFR 193 (U.S. Department of Transportation 1991b); and one State of California Regulation (Public Utilities Commission of the State of California 1979).

### **III-2.3.3 Gas And Liquid Fuel Plant Facilities**

At present, there are no codes or standards that apply directly to the seismic design of gas and liquid fuel plant facilities. Buildings that house critical components and systems and personnel must be designed to withstand the effects of design-level earthquakes. While some degree of damage may be permissible, the buildings should not fail catastrophically or in such a manner as to interfere with the function of critical systems or threaten personnel safety. Procedures for the analysis and design of buildings are summarized in codes such as the Uniform Building Code (UBC). Code-defined importance factors can be used as a rational basis for increasing lateral seismic design forces for essential and/or hazardous facilities.

The seismic design of a pipeline system should include the configuration and qualification of monitoring and control systems to have adequate resistance to the effects of earthquake ground motions that might occur during the operational life of the project. The most critical systems include the data measurement, communication, acquisition, and processing systems that control pipeline operations, remote valves, and emergency systems. Online or backup power supplies for critical systems are also essential. The performance objective for critical systems is that they function to the extent necessary during and following an earthquake to provide vital monitoring, control, and safety functions. Other systems needed for operation, but otherwise not essential for safety or control, may be qualified to a lesser extent to meet operational objectives.

Seismic qualification is the process whereby through analysis, testing, or engineering evaluation/judgment, it is demonstrated that equipment can perform an intended operating function in a specified earthquake environment. Equipment qualification programs sometimes have been based on the guideline standard developed by the nuclear industry (IEEE-344), but these approaches are overly conservative for most pipeline components, except perhaps for the more important control and instrumentation systems.

The first step in the equipment qualification process is to establish earthquake performance objectives for individual systems. This effort requires knowledge of the details of pipeline system operation and identification of systems essential for system monitoring, shutdown, and contingency response. The vehicle often used to characterize equipment performance objectives is a mutually exclusive set of seismic categories that prescribe required performance (Anderson and Nyman 1979).

The qualification of cabinet-mounted electronic components has often involved shake-table testing to simulate earthquake vibratory motion, but more recently, such testing has become largely unnecessary due to the use of lightweight, solid-state components mounted in well-fabricated cabinets and enclosures. Typically, in such cases, engineering inspection of cabinets, enclosures, internals, and anchorage is sufficient to demonstrate seismic adequacy. Elevated computer floors require special attention to guard against collapse and associated damage to computer hardware.

In the case of mechanical equipment, a useful guide for seismic qualification can be gained from examining the past performance during previous destructive earthquakes. Reports on earthquakes in Managua, Nicaragua, and Alaska have all indicated the same conclusion:

## RECOMMENDATIONS FOR LIFELINE SEISMIC STANDARDS

mechanical equipment, such as pumps and compressors, etc., can be expected to withstand intense earthquake motions provided they are properly anchored.

The potential for nonstructural damage due to overturning of furniture, storage racks, and unanchored equipment or falling of HVAC, conduit, cable trays, and suspended ceilings should also be addressed. In particular, noncritical items should not be allowed to inflict damage on critical components.

### III-2.3.4 Seismic Contingency Plans

Pipeline companies have established operating procedures to handle many types of general contingency situations. From the company's point of view, contingencies resulting from earthquake damage are not altogether different from other contingencies, such as those resulting from improper excavation, storms, or fires, except that following earthquakes many such contingencies may occur simultaneously. Furthermore, in the event of a great earthquake, the ability to respond to contingency situations or to restore a pipeline to operation would be seriously impaired by the general devastation to the infrastructure in the area. Thus, it is important that provision be made for independent communications and uninterruptible power sources, all of which should be qualified to survive a design-level earthquake.

Activities of the type delineated below are currently incorporated into oil and gas company operating procedures in conformance with requirements of Federal, State, and local regulations:

- A detailed operations plan is documented in a manual. This documentation provides procedures and instructions for the proper response to the report of a pipeline contingency; establishes communications with police, fire officials, etc.; specifies responsibility of key personnel; and states other tasks necessary to minimize the hazard. Shutdown plans are pre-engineered so that a shutdown can be performed by operating personnel with minimal engineering or management support.
- A training program that ensures that personnel can respond appropriately in contingency situations is established. The effectiveness of the training program is verified by periodic seminars, drills, testing, etc.
- Liaison is established and maintained with appropriate fire, police, and other public officials to acquaint all parties with the types of hazards involved and to plan for the mitigation of these hazards. These parties are included in training exercises (see above) where practical.
- Reliable independent (noncommercial) backup communications are established with repair personnel, public officials and relief agencies, and other operating companies.
- Proper as-built documentation defining pipeline specifications, operating pressure, type of product carried, route, and other information on the condition of the pipeline is maintained.
- Programs are established to educate the public and appropriate government organizations to recognize the occurrence of a pipeline contingency and to report it to the appropriate officials.
- Plans for postearthquake inspection that permit rapid evaluation of the condition of the

pipeline and required repairs have been established.

- Standard repair plans for anticipated earthquake damage scenarios including utilization of mutual assistance programs with other utilities have been drawn up.

For shop and warehouse facilities, some effort is required to store repair parts, tools, and equipment in a manner such that they are not damaged or cause injury to workers during an earthquake but are readily available and usable following an earthquake. Normally, the hazard can be eliminated by securing storage bins, machines, tools, etc., and by properly storing such equipment when not in use.

### **III-2.4 Research Needs**

Key input parameters for the assessment of the earthquake vulnerability of gas and liquid fuel systems include seismicity, identification of areas susceptible to liquefaction (lateral spreading and flow slides) and landslides, and characterization of expected ground movements. Unfortunately, none of these parameters are very well defined, leaving considerable space for judgment and extrapolation. For example:

- Estimates of recurrence interval for earthquakes in the central and eastern United States are needed. The uncertainty is due largely to the absence of surface fault expression east of the Rockies. A more accurate prediction of earthquake recurrence would allow a more perceptive evaluation of cost-benefit considerations for seismic improvements to gas and liquid fuel systems.
- Detailed studies of various pipeline alignments using site-specific soils information are needed to quantify areas prone to liquefaction.
- Simple methods to characterize ground movements and distortion are needed. The LSI methodology (Youd and Perkins 1987) is a good start, but a probabilistic technique for developing the spatial distribution of horizontal strain through a given liquefiable zone, including river crossings, would be more useful for evaluating pipeline performance.

There are also cases where the present understanding and design practice are based on very limited test data or concepts extrapolated from other design areas. Examples include:

- At present, existing pipeline strain criteria are based on theory, limited testing, and the consensus opinion of a number of expert practitioners. Better quantification of failure limit states, particularly compressive wrinkling, is needed to reduce uncertainty. Also, the influence of pipe grade and welding procedure should be investigated thoroughly. This information could be developed through test programs combined with analytical methods.
- The loading transmitted to the pipeline and the restraint of the pipeline provided by the surrounding soil medium in the zone of differential movements should be investigated experimentally. Further testing, especially of prototype pipe sizes in real time (i.e., at strain rates consistent with earthquake ground movements) under field conditions, is needed to validate existing methodology.

As a political issue, it is noted that the interest of the public in being protected from energy

## *RECOMMENDATIONS FOR LIFELINE SEISMIC STANDARDS*

shortages is not necessarily compatible with the financial interest of the pipeline companies. Innovative concepts for financing pipeline seismic improvements (e.g., Federal subsidies, grants, or tax incentives) should be explored.

### **III-3. PLAN FOR DEVELOPMENT OF SEISMIC STANDARDS**

Other than the seismic design criteria contained in API Standard 650 for liquid storage tanks, no seismic standards for gas and liquid fuel systems exist. The American Society of Civil Engineers (ASCE) guidelines for seismic design of oil and gas pipelines provides valuable guidance, but without mandatory national standards, little progress will be made in the seismic upgrading of gas and liquid fuel systems.

Determining the appropriate level of earthquake resistance for gas and liquid fuel systems is a key policy issue that must be decided prior to the development of seismic standards. It is proposed that this issue be addressed by first establishing system performance objectives for gas and liquid systems and relevant measures of system performance. Next, a vulnerability assessment of gas and liquid fuel systems is proposed as a means of developing a basis for establishing systems performance criteria.

Following the vulnerability assessment, performance-based model standards for seismic design, seismic retrofitting, and earthquake preparedness will be developed for four general topic areas, i.e., transmission lines, distribution systems, oil storage tanks, and refineries. The model standards should be in a form suitable for transformation to voluntary consensus standards by appropriate industry organizations such as the American Petroleum Institute (API) and the American Gas Association (AGA). In conjunction with the development of model standards, gaps or shortcomings in existing knowledge will be identified, and proposed research and development studies will be formulated for each topic area.

The establishment of system performance objectives and measures, vulnerability assessment, seismic standards development, and research initiatives are summarized in the next sections as four project phases. Each phase involves participation by a selected contractor, a panel of lifeline experts, and the industry at large. The selection of the contractor and expert panel members should be based on demonstrated technical ability and expertise in the gas and liquid fuel lifelines area. Potential sources for these technical participants include the ASCE Technical Council on Lifeline Earthquake Engineering (TCLEE), the American Society of Mechanical Engineers (ASME), and the National Center for Earthquake Engineering Research (NCEER). Participants from the industry at large should be furnished through recognized industry organizations, namely API and AGA.

#### **III-3.1 System Performance Objectives**

The first step in the development of seismic standards for gas and liquid fuel lifelines is to provide a clear delineation of the appropriate level of earthquake resistance required to satisfy system performance objectives. The appropriate level of earthquake resistance for new and existing systems should be determined on the basis of economic benefit, environmental and safety consequences, and system redundancy. To the extent that design mitigation is not economically feasible, objectives for contingency response, repair, and restoration should be clearly defined.

This phase of the standards development project should be a joint effort of a qualified contractor selected by the Federal Government, a panel of lifeline experts, and the oil and gas industry. It is

envisioned that the industry representatives would be provided through AGA and API and would participate actively in developing the seismic performance objectives and measures of performance for gas and liquid fuel systems so as to achieve a consensus position.

To facilitate the development of the consensus position on system performance objectives and measures of system performance, a workshop attended by the project participants and invited observers from the industry at large would be conducted. The products of the workshop would be a collection of invited papers and a summary of the workshop consensus.

<b>Developers:</b>	Contractor, with assistance from an expert panel, and industry participants provided through API and AGA
<b>Duration:</b>	12 to 15 months
<b>Cost:</b>	\$250,000
<b>Funding:</b>	Federal Government for contractor and expert panel; API and AGA for industry participants

### III-3.2 Vulnerability Assessment

The impact of earthquake damage differs among the various types of gas and liquid fuel facilities. For example, transmission line damage may cause a shortfall in energy supply hundreds of kilometers away from the earthquake damage area. Damage to gas distribution systems would primarily affect customers in the local service area, and service can be restored in a majority of situations before the customers are able to accept the service (i.e., due to damage to customer property). For liquid storage tanks, the primary objective is to avoid catastrophic release of contents and the concomitant risk of collateral damage to adjacent facilities or to the environment. For refineries the goal would be to ensure personnel safety, minimize capital loss, and minimize or avoid the types of damage that would curtail or drastically limit throughput.

The major benefits of providing greater seismic resistance for gas and liquid fuel systems are reduced economic loss to facility owners and energy consumers, increased safety, and mitigation of potential environmental damage. Gas and liquid fuel systems that have a reasonable degree of seismic resistance should withstand moderate earthquakes with only isolated cases of minor damage. However, the cost associated with preventing damage due to strong earthquakes is likely to be excessive, i.e., for some earthquake hazard situations, it is more cost-effective to accept the risk of damage and repair if and when required.

A seismic vulnerability assessment of gas and liquid fuel systems is proposed for the following purposes:

- To examine relevant measures of system performance, e.g., system outage or restoration times, population without service, etc.
- To examine the economic impact of system failures.
- To evaluate the seismic resistance and restoration capability of gas and liquid fuel systems.

The level or detail of analysis will depend upon a number of factors. In general, what is

## RECOMMENDATIONS FOR LIFELINE SEISMIC STANDARDS

important in performing a systems analysis is to determine the relevant impact that individual components have on overall system performance. If significant accuracy is required to quantify the impact of certain failures, then more detail will be necessary in developing the data and models used in the systems analysis.

By performing systems studies, a better understanding of system performance criteria can be developed. For example, it may be possible to achieve system performance objectives through a combination of increased seismic design criteria and system redundancy. The benefit of using system redundancy to achieve performance goals is that the design requirements for each component can be lowered as long as safety and environmental requirements are met. The results of these systems analyses will help to better define the individual design requirements for gas and liquid fuel components.

Seismic risk assessments have been performed for oil transmission pipelines in the New Madrid area by NCEER (Arman et al. 1990) and gas distribution systems in Utah (Taylor et al. 1986; 1988). A recent study by the Applied Technology Council (1991), referred to as ATC-25, provided a general characterization of the impact of disruption of lifelines from earthquakes at the regional level and to assist in the identification and prioritization of hazard mitigation measures and policies. A West Coast gas distribution utility recently implemented a 10-year program to increase the seismic resiliency of its gas system and to improve its ability to restore service to customers after damaging earthquakes (Pacific Gas and Electric Company 1990).

The proposed seismic vulnerability assessment is intended to take full advantage of risk and vulnerability assessments performed to date for a number of transmission and distribution pipeline systems in the central and western United States. As a first step, existing methodologies for performing vulnerability assessments and the results of completed studies will be compiled and reviewed. Specific attention will be given to the evaluation of the economic benefits of providing specific levels of seismic resistance or rapid restoration and to the validation of risk studies to actual gas and liquid fuel damage history. Information and knowledge gaps will be identified, and additional vulnerability studies to characterize regional differences, system configurations, etc., will be conducted as needed.

The selection of gas and liquid fuel systems for seismic vulnerability assessment requires the cooperation of certain gas utilities, pipeline companies, and oil companies (refineries). Ideally, the distribution of selected facilities would be as follows:

- Transmission system
  - Gas, West Coast
  - Oil, central United States
- Gas distribution
  - Los Angeles or San Francisco
  - Memphis
- Liquid storage tanks, West Coast, three sites
- Refinery, West Coast

Pipeline systems would be assessed for vulnerability to geotechnical hazards, such as

## GAS AND LIQUID FUEL LIFELINES

liquefaction, fault movements, and landslides. Some subsurface exploration might be required at two to four sites. Pump and compressor stations and communications facilities would be reviewed for seismic integrity. Other gas and liquid fuel facilities would be examined via walk-through inspections to evaluate the seismic integrity of structures, mechanical equipment, control systems, communications, fire suppression equipment, and maintenance facilities. Contingency response plans would be evaluated for all of the lifeline systems selected for vulnerability assessments.

For transmission pipelines, the vulnerability assessment will include an evaluation of the estimated time to restore the system to full operation and the associated impact on the customers. A similar evaluation would be made for gas distribution systems, but additional consideration would be given to the integrity of customer service lines, customer property damage and its effect on gas demand, and the benefits of automatic shutoff valves.

It is proposed that the earthquake vulnerability assessment be carried out by the Federal Government, with input from the oil and gas industry. It is envisioned that a contractor and an expert panel would conduct the vulnerability assessment with input from API and AGA. The product of this phase will be a report characterizing the seismic vulnerability and describing seismic resistance requirements for gas and liquid fuel systems.

**Developers:** Contractor, with assistance from an expert panel, and industry participants provided through API and AGA

**Duration:** 2 years

**Cost:** \$500,000

**Funding:** Federal Government for contractor and expert panel; API and AGA for industry participants

### III-3.3 Model Standards Development

The development of model seismic standards for gas and liquid fuel systems will be an implementation of the consensus on seismic resistance requirements established at the conclusion of the vulnerability assessment. Four separate standards will be developed to cover gas and liquid fuel systems:

- **Transmission Lines**--Natural gas, crude oil, and crude oil products, in two parts:
  - New construction
  - Existing systems
- **Distribution Systems**--Natural gas, existing systems with provision for replacement and extensions
- **Oil Storage Tanks**--New construction and existing tanks
- **Refineries**--New construction and existing facilities

The organization of the gas and liquid fuel standards according to the broad general categories cited above is generally consistent with the organization of existing nonseismic standards for

## RECOMMENDATIONS FOR LIFELINE SEISMIC STANDARDS

these facilities, e.g., 49 CFR 192 (ANSI B31.8) for gas systems, 49 CFR 195 (ANSI B31.4) for liquids, and API Standard 650 for tanks. There are common technical topics or system components that should be given consistent and uniform treatment among the four standards. For example, provisions applicable to structures, control systems, and piping are needed in the standards for transmission lines, distribution systems, and refineries. Similarly, provisions addressing line pipe, soil-pipeline interaction, and communications are an important consideration in the standards for transmission lines and distribution systems. From a production viewpoint, it is apparent that a number of standard subsets can be developed as singular efforts and integrated into the four standards as applicable.

### III-3.3.1 Transmission Lines

The model seismic standard for transmission lines will consist of two parts: one part devoted exclusively to new construction of transmission pipeline systems, and the second part devoted to existing transmission pipeline systems. This separation is made because new pipelines, especially interstate lines, are major projects requiring extensive right-of-way acquisition, permitting, and regulatory compliance. Seismic geotechnical hazards could be avoided to a large extent with favorable routing, and other seismic design issues could be addressed without adding much incremental cost to the project.

The available options for improving seismic resistance of existing transmission pipeline systems are appreciably different than for new construction. Emphasis will be placed on development of performance standards for pipeline control systems and contingency measures for dealing with pipeline damage along the right-of-way.

**Developers:** Contractor, with assistance from an expert panel, and industry participants provided through API and AGA

**Duration:** 3 years

**Cost:** \$750,000

**Funding:** Federal Government for contractor and expert panel; API and AGA for industry participants

### III-3.3.2 Distribution Systems

In the case of distribution lines, new construction relates primarily to expansion of the customer base in new development areas (perhaps an increase of several percent in certain growth areas). Hence, the standard for distribution systems will focus on considerations for expansion of existing systems, cost-effective retrofitting that could improve seismic resistance, and preparedness measures that could expedite postearthquake repair and restoration. Particular attention will be given to the replacement or rejuvenation of deteriorated pipe and system expansion. Considerations for customer service lines and automatic shutoff valves would also be addressed.

**Developers:** Contractor, with assistance from an expert panel, and industry participants provided through AGA

**Duration:** 3 years



**Cost:** \$750,000

**Funding:** Federal Government for contractor and expert panel; AGA for industry participants

### III-3.3.3 Oil Storage Tanks

The emphasis of the standard for oil storage tanks will be the evaluation of older tanks and attached piping that may have been designed without special regard for seismic response. For tanks having marginal seismic resistance, special provisions for retrofit or containment will be introduced. For new tanks, the standard will reference API Standard 650, but possibly will alter certain analysis parameters, e.g., seismic load coefficients. Optionally, API might elect to make certain changes to API Standard 650 consistent with the conclusion of the tank seismic standards effort.

**Developers:** Contractor, with assistance from an expert panel, and industry participants provided through API Standard 650 Technical Committee

**Duration:** 2 years

**Cost:** \$200,000 excluding API expense

**Funding:** Federal Government for contractor and expert panel; API for industry participants

### III-3.3.4 Refineries

Refineries generally have been designed to seismic codes such as UBC, and earthquake performance has typically been good for facilities where seismic design practices have been incorporated. The principal shortcoming is that there is currently no consensus among designers and owners regarding the appropriate level of seismic resistance for refining facilities and performance objectives for the various operational systems.

It is proposed that the standard for refineries will be patterned after the 1991 edition of the UBC (International Conference of Building Officials 1991) seismic provisions for buildings with design coefficients and parameters specified as applicable for various structural and mechanical components. Special consideration will be given to seismic qualification of critical control systems, fire suppression systems, and communications. The retrofit and/or modification of older facilities will also be addressed.

**Developers:** Contractor, with assistance from an expert panel drawn from ASCE Energy Division Committee on Petrochemical Energy, and industry participants provided through API

**Duration:** 2 years

**Cost:** \$300,000

**Funding:** Federal Government for contractor and expert panel; API for industry participants

## RECOMMENDATIONS FOR LIFELINE SEISMIC STANDARDS

### III-3.4 Identification And Initiation Of Research

A number of research needs relating to seismic hazard quantification were listed in Section III-2.4. These included seismicity, identification of areas susceptible to liquefaction (lateral spreading and flow slides) and landslides, and characterization of expected ground movements. For design applications, the need for a better understanding of soil-pipeline interaction under large displacement conditions and postbuckling behavior of line pipe was identified. These research needs and others that might be identified during the establishment of system performance objectives and measures, vulnerability assessment, and standards development should be formulated as project work scopes. The work should then be funded and initiated by the appropriate organizations.

**Developers:** Contractor, with assistance from an expert panel, and industry participants provided through API and AGA. Universities and consultants would conduct the actual research.

**Duration:** 6 months to complete research needs report. Indefinite (on the order of 5 years) to conduct the research.

**Cost:** \$50,000 to identify and scope research needs; \$3,000,000 to perform research.

**Funding:** Federal Government for contractor and expert panel; API and AGA for industry participants; FEMA, NSF, and DOT for research funding.

### III-3.5 Cost And Schedule Summary

The total estimated costs for establishing system performance objectives and measures, performing vulnerability assessment, developing the four gas and liquid fuel standards, and identifying research needs is \$2,850,000. The costs for conducting the recommended research is estimated to be approximately \$3,000,000, depending on the identified gaps in knowledge. A breakdown of these costs by activity is provided in Table 1.

It is believed that industry organizations, such as API and AGA, would actually undertake the effort to transform each of the model standards to voluntary consensus standards. It would be advisable for the industry standards committees to utilize key participants that were engaged in the model standards development for technical assistance in the consensus standards effort. The estimated costs for model standards development include an allowance for contractor/expert panel interaction with the industry standard committee.

The work scope for the standards program is expected to take a total of four years. The research program is expected to take approximately five years, starting about three years downstream in the standards program. A bar chart depicting the program schedule is provided in Figure 12.

## III-4. ACKNOWLEDGMENTS

This chapter was developed by Douglas J. Nyman of D.J. Nyman & Associates under contract with the National Institute of Standards and Technology. The contribution of the following expert reviewers to the content of this plan is gratefully acknowledged: Thomas L. Anderson, Fluor Daniel, Inc.; Charles B. Crouse, Dames & Moore; William J. Hall, University of Illinois; Peter W. McDonough, Mountain Fuel Supply Company; and Thomas D. O'Rourke, Cornell University. Valuable comments and suggestions were also received from the steering group

chairman, Ronald T. Eguchi of EQE International.

### III-5. REFERENCES

1. American Petroleum Institute, 1988, "Welded Steel Tanks for Oil Storage," API Standard 650, Eighth Edition, November.
2. American Petroleum Institute, 1989, "Recommended Practice for Planning, Designing and Constructing Fixed Offshore Platforms," API Recommended Practice 2A, Eighteenth Edition, September 1.
3. American Petroleum Institute, 1990, "Design and Construction of Large, Welded Low Pressure Storage Tanks," API Standard 620, Eighth Edition, June.
4. American Society of Civil Engineers (ASCE), Technical Council on Lifeline Earthquake Engineering, Committee on Gas and Liquid Fuel Lifelines, 1984, *Guidelines for the Seismic Design of Oil and Gas Pipeline Systems*, New York, 473 p.
5. Anderson, T. L., 1984, "Pipeline Fault-Crossing Design Strategy," *Proceedings 8th World Conference on Earthquake Engineering*, San Francisco.
6. Anderson, T. L., and D. J. Nyman, 1979, "Lifeline Engineering Approach to Seismic Qualification," *Journal of the Technical Councils of ASCE*, no. TC1, pp. 149-161.
7. Applied Technology Council, 1978, Tentative Provisions for the Development of Seismic Regulations for Buildings, Publication ATC 3-06.
8. Applied Technology Council, 1991, Seismic Vulnerability and Impact of Disruption of Lifelines in the Conterminous United States, Publication ATC-25, Redwood City, California, prepared by C. Scawthorn and M. Khater, EQE, Inc., San Francisco, California.
9. Ariman, T., R. Dobry, M. Grigoriu, F. Kozin, M. O'Rourke, T. O'Rourke, and M. Shinozuka, 1990, Pilot Study on Seismic Vulnerability of Crude Oil Transmission Systems, Technical Report NCEER-90-0008, National Center for Earthquake Engineering Research, Buffalo, New York.
10. Audibert, J. M. E., and K. J. Nyman, 1977, "Soil Restraint Against Horizontal Motion of Pipes," *Journal of the Geotechnical Engineering Division*, ASCE, vol. 99, no. TE3, pp. 521-536.
11. Beavers, J. E., R. G. Domer, R. J. Hunt, and R. M. Rotty, December 1986, Vulnerability of Energy Distribution Systems of an Earthquake in the Eastern United States - An Overview, American Association of Engineering Societies.
12. Bouwkamp, J. G., and R. M. Stephen, 1973, "Large Diameter Pipe Under Combined Loading," *Journal of the Transportation Engineering Division*, ASCE, vol. 99, no. TE3, pp. 521-536.
13. Earthquake Engineering Research Institute (EERI), 1973, Reconnaissance Report Imperial County, California, Earthquake, ed. D. J. Leeds, Berkeley, California.

## RECOMMENDATIONS FOR LIFELINE SEISMIC STANDARDS

14. Earthquake Engineering Research Institute (EERI), 1980, *Conference Proceedings, Nov. 29-30, Managua, Nicaragua, Earthquake of December 23, 1972*, San Francisco, California.
15. Environmental Science Services Administration (ESSA), 1966, *The Parkfield, California Earthquake of June 27, 1966*.
16. Federal Emergency Management Agency, February 1986, *1985 Edition of NEHRP Recommended Provisions for the Development of Seismic Regulations for New Buildings*, FEMA-96.
17. Giuliano, F.A., 1981, Editor, *Introduction to Oil and Gas Technology*, Second Edition, International Human Resources Development Corporation, Boston, Massachusetts.
18. Hall, W. J., 1986, "Earthquake Engineering Research Needs Concerning Gas and Liquid Fuel Pipelines," *Abatement of Seismic Hazards to Lifelines: Proceedings of a Workshop on Development of An Action Plan*, vol. 5, prepared for the Federal Emergency Management Agency, Building Seismic Safety Council, Washington, D.C.
19. Housner, G. W., 1957, "Dynamic Pressures on Accelerated Fluid Containers," *Bulletin of the Seismological Society of America*, vol. 47, pp. 15-35.
20. International Conference of Building Officials, 1991, *Uniform Building Code (UBC)*, Whittier, California.
21. Isenberg, J., 1978, *The Role of Corrosion in the Seismic Performance of Buried Steel Pipelines in Three United States Earthquakes*, Grant Report No. 6 to National Science Foundation, Weidlinger Associates, Palo Alto, California.
22. Jones, D. J., G. S. Kramer, D. N. Gideon, and R. J. Eiber, 1986, "An Analysis of Reportable Incidents for Natural Gas Transmission and Gathering Lines 1970 through June 1984," Report to Line Pipe Research Supervisory Committee of the American Gas Association, Battelle, Columbus, Ohio.
23. Katayama, T., K. Kubo, and N. Sato, 1975, "Earthquake Damage to Water and Gas Distribution Systems," *Proceedings, U.S. National Conference on Earthquake Engineering*, Ann Arbor, Michigan, EERI, pp. 396-407.
24. Kennedy, R. P., 1977, "General Consideration for Seismic Design of Oil Pipeline Systems," *Proceedings, Technical Council on Lifeline Earthquake Engineering Specialty Conference: The Current State of Knowledge of Lifeline Earthquake Engineering*, ASCE, Los Angeles, California, August 30-31, pp. 2-17.
25. Kennedy, R. P., A. W. Chow, and R. A. Williamson, 1977, "Fault Movement Effects on Buried Oil Pipeline," *Journal of the Transportation Engineering Division*, ASCE, vol. 103, no. TE5, pp. 617-633.
26. Krinitsky, E. L., 1974, "Fault Assessment in Earthquake Engineering," Report No. 2, M.P. S-73-1, U.S. Army Engineer Waterways Experiment Station.
27. Kubo, K., 1979, "Effect of Miyagi-Oki Earthquake on Lifeline Systems," *Proceedings*,

## GAS AND LIQUID FUEL LIFELINES

- Second U.S. National Conference on Earthquake Engineering*, Stanford, California, EERI, pp. 343-352.
28. Miyamoto, H., et al., 1970, "Experiments on the Behavior of Underground Pipes During Earthquakes," *Proceedings, Third Japan Earthquake Engineering Symposium*, pp. 129.
  29. National Academy of Sciences (NAS), 1971, Engineering, *The Great Alaska Earthquake of 1964*.
  30. National Fire Protection Association, Inc. (NFPA), 1975, NFPA Standard for the Production, Storage and Handling of Liquefied Natural Gas (LNG), Boston, Massachusetts.
  31. National Oceanic and Atmospheric Administration (NOAA), 1973, San Fernando, California, *Earthquake of February 9, 1971, Utilities, Transportation and Sociological Aspects*, Vol. II.
  32. National Petroleum Council, April 1989, *Petroleum Storage and Transportation*, U.S. Department of Energy.
  33. Newmark, N. M., and W. J. Hall, 1975, "Pipeline Design to Resist Large Fault Displacement," *Proceedings of the U.S. National Conference on Earthquake Engineering*, Ann Arbor, Michigan, pp. 416-425.
  34. Nyman, D. J., 1986, "Operations and Maintenance Considerations for Mitigation of Earthquake Effects on Oil and Gas Pipelines," *Abatement of Seismic Hazards to Lifelines: Proceedings of a Workshop on Development of An Action Plan*, vol. 5, prepared for the Federal Emergency Management Agency, Building Seismic Safety Council, Washington, D.C.
  35. Nyman, D. J., and W. J. Hall, 1991, "Scenario for Improving the Seismic Resistance of Pipelines in the Central United States," *Proceedings, Third U.S. Conference on Lifeline Earthquake Engineering*, ASCE, Los Angeles, California.
  36. Nyman, D. J., and R. P. Kennedy, 1986, "Seismic Design of Oil and Gas Pipeline Systems," *Abatement of Seismic Hazards to Lifelines: Proceedings of a Workshop on Development of An Action Plan*, vol. 5, prepared for the Federal Emergency Management Agency, Building Seismic Safety Council, Washington, D.C.
  37. O'Rourke, M., 1988, "Seismic Analysis Procedures for Welded Steel Pipeline," *Proceedings of 1st Japan - United States Workshop on Liquefaction, Large Ground Deformation and their Effects on Lifeline Facilities*, sponsored by Association for the Development of Earthquake Prediction (Japan) and the National Center for Earthquake Engineering Research (U.S.), held at Zendentsu-rodo Kaikan, Tokyo, Japan, November 16-18.
  38. O'Rourke, T. D., 1986, "Geotechnical Considerations for Buried Pipelines," *Abatement of Seismic Hazards to Lifelines: Proceedings of a Workshop on Development of An Action Plan*, vol. 5, prepared for the Federal Emergency Management Agency, Building Seismic Safety Council, Washington, D.C.

## RECOMMENDATIONS FOR LIFELINE SEISMIC STANDARDS

39. O'Rourke, T. D., M.D. Grigoriu, and M. M. Khater, 1985, "Seismic Response of Buried Pipelines," *Pressure Vessel and Piping Technology - 1985 - A Decade of Progress*, American Society of Mechanical Engineers, New York.
40. O'Rourke, T. D., and P. A. Lane, 1989, "Liquefaction Hazards and their Effects on Buried Pipelines," Technical Report NCEER-89-0007, National Center for Earthquake Engineering Research, Buffalo, New York, February 1.
41. Pacific Gas and Electric Company, 1990, "Program for Reducing Earthquake Vulnerability of Gas and Electric Systems by the Year 2000," Report to the California Public Utility Commission.
42. Public Utilities Commission of the State of California, 1979, General Order No. 112-D, Rules Governing Design, Construction, Testing, Maintenance, and Operation of Utility Gas Gathering, Transmission, and Distribution Piping Systems, Liquefied Natural Gas Facilities Safety Standards, California.
43. Richardson, C. B., 1973, "Damage to Utilities," *The Great Alaskan Earthquake of 1964*, Committee on Alaska Earthquake, National Academy of Sciences, pp. 1034-1073.
44. Schuster, R.L., and R. W. Fleming, 1982, "Geologic Aspects of Landslide Control Using Walls," *Application of Walls to Landslide Control*, ASCE, pp. 1-18.
45. Steinbrugge, K. V., E. E. Schader, H. C. Bigglestone, and C. A. Weers, 1971, San Fernando Earthquake, February 9, 1971, Pacific Fire Rating Bureau, San Francisco, California.
46. Taylor, C. E., M. Salmon, R. Eguchi, R. Campbell, and C. Tillman, 1988, "Continuing Investigations of Earthquake Risk to Utah Water and Gas Systems," NTS Engineering, U.S.G.S. Contract #14-08-0001-G1394.
47. Taylor, C. E., J. H. Wiggins, J. M. Haber, and D. B. Ward, 1986, "A Systems Approach to Wasatch Front Seismic Risk Problems," NTS Engineering, U.S.G.S. Contract #14-08-001-22013.
48. U.S. Department of Transportation (DOT), 1991a Transportation of Natural and Other Gas by Pipeline, Title 49, Code of Federal Regulations (CFR), Part 192.
49. U.S. Department of Transportation (DOT), 1991b Liquefied Natural Gas Facilities: Federal Safety Standards, Title 49, Code of Federal Regulations (CFR), Part 193.
50. U.S. Department of Transportation (DOT), 1991c Transportation of Hazardous Liquids by Pipeline, Title 49, Code of Federal Regulations (CFR), Part 195.
51. Wilson, W. M., and N. M. Newmark, 1933, *The Strength of Thin Cylindrical Shells and Columns*, University of Illinois Experiment Station, Bulletin 255, Urbana.
52. Yokel, F. Y., and R. G. Mathey, 1991, "Earthquake Resistant Construction of Fuel Transmission Systems Serving, or Regulated by, the Federal Government," in draft, U.S. Department of Commerce, National Institute of Standards and Technology, Gaithersburg, Maryland.

## GAS AND LIQUID FUEL LIFELINES

53. Youd, T. L., and D. M. Perkins, 1987, "Mapping of Liquefaction Severity Index," *Journal of the Geotechnical Division*, ASCE, vol. 113, no. 11, pp. 1374-1392.
54. Youd, T. L., D. M. Perkins, and W. G. Turner, 1989, "*Liquefaction Severity Index for the Eastern United States*," *Proceedings, Second U.S. - Japan Workshop on Liquefaction, Large Ground Deformation, and their Effects on Lifeline Facilities*, National Center for Earthquake Engineering, Buffalo, New York, pp. 438-452.

RECOMMENDATIONS FOR LIFELINE SEISMIC STANDARDS

TABLE 1

SUMMARY OF ESTIMATED COSTS AND SCHEDULE  
SEISMIC STANDARDS FOR GAS AND LIQUID FUEL SYSTEMS

<b>Phase</b>	<b>Cost</b>	<b>Time (Years)</b>
System Performance Objectives	\$250,000	1 - 1.25
Vulnerability Assessment	500,000	2
Model Standards Development		
Transmission Lines	750,000	3
Distribution Systems	750,000	3
Oil Storage Tanks	250,000	2
Refineries	300,000	2
Research		
Identification	50,000	1
Performance	3,000,000	3
TOTAL WITHOUT RESEARCH	\$2,850,000	
TOTAL WITH RESEARCH	\$5,850,000	



GAS AND LIQUID FUEL LIFELINES

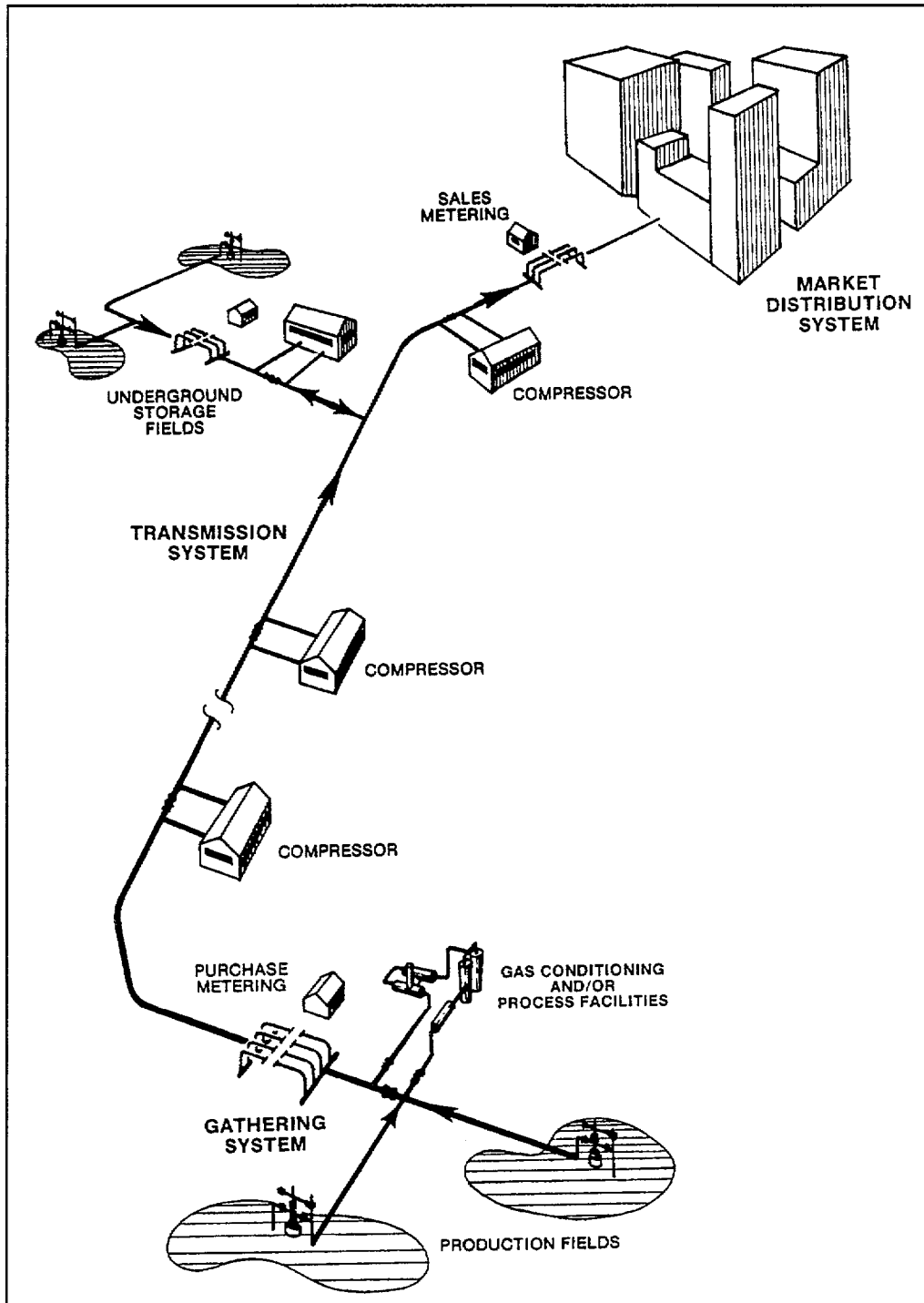


Figure 1. Schematic of natural gas pipeline system (after National Petroleum Council, 1980).

RECOMMENDATIONS FOR LIFELINE SEISMIC STANDARDS

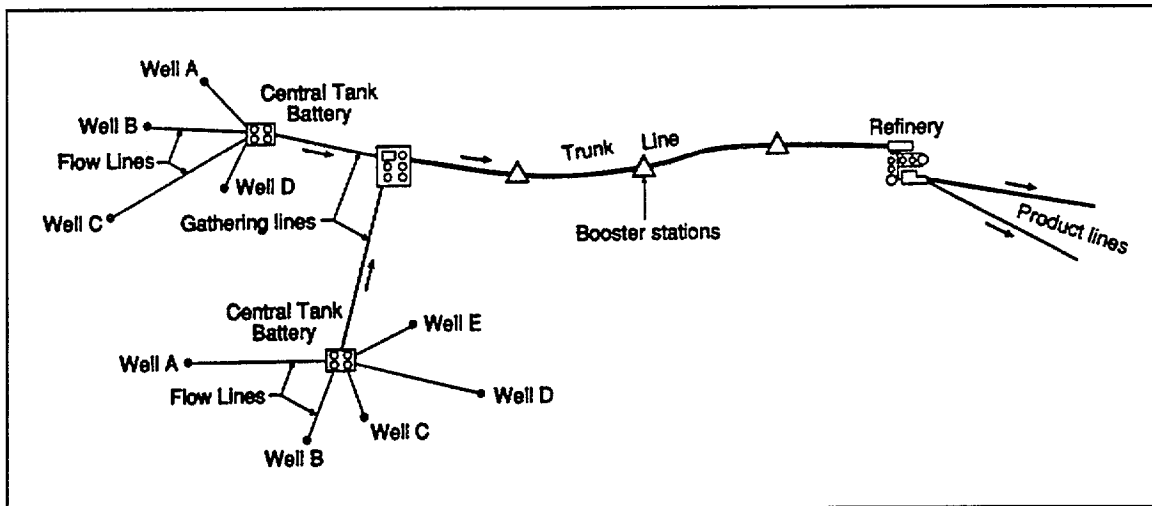


Figure 2. Schematic of liquid fuel pipeline system (after Yokel and Mathey, Giuliano, 1981).

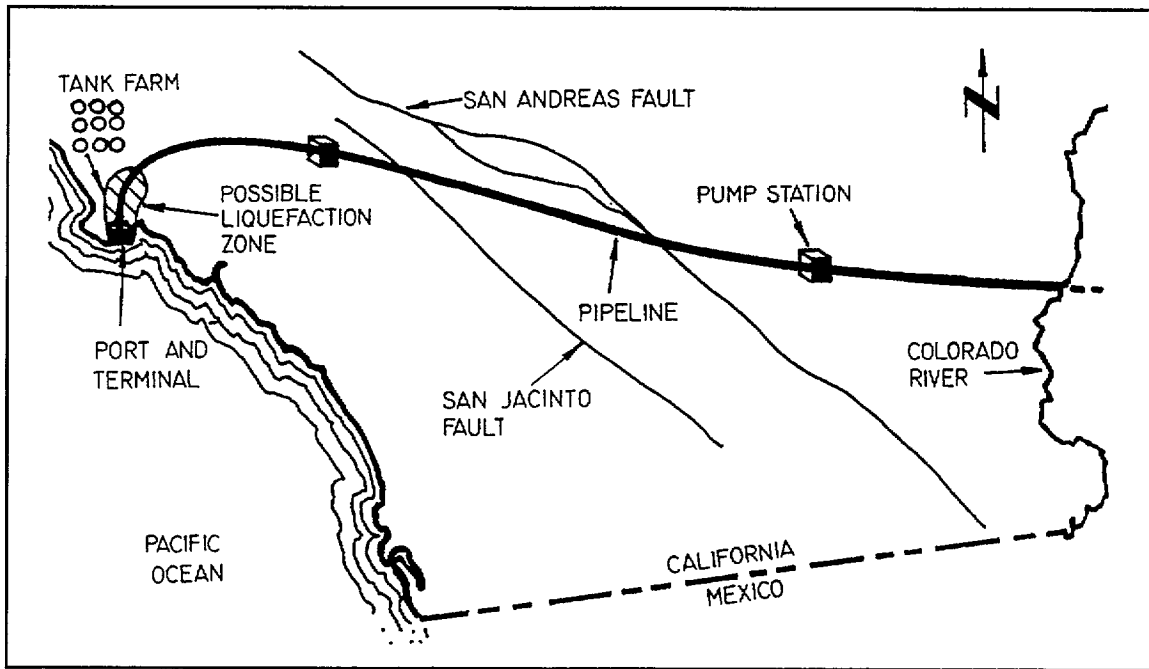


Figure 3. Seismic hazards affecting transmission systems (after Kennedy et al., 1977).

RECOMMENDATIONS FOR LIFELINE SEISMIC STANDARDS

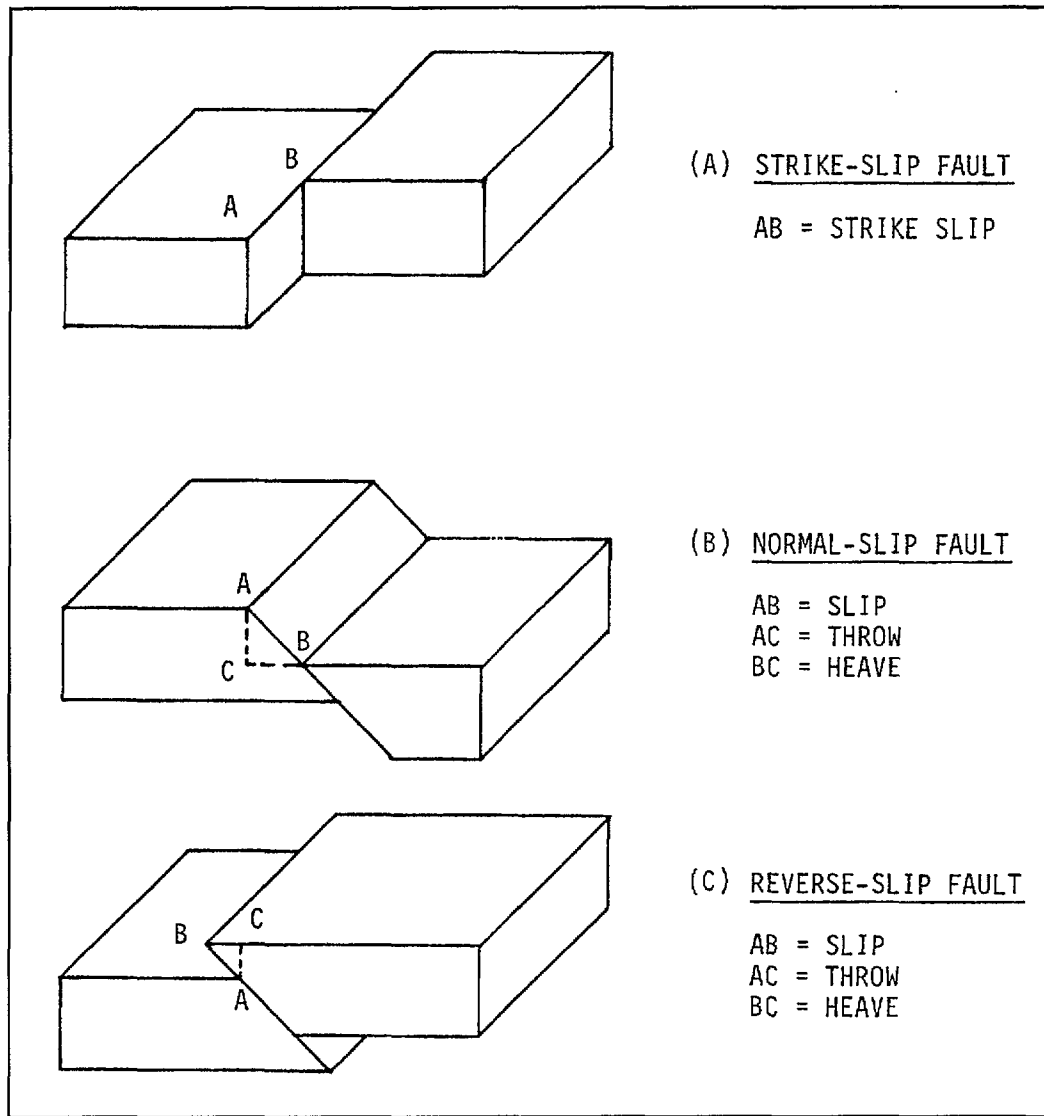


Figure 4. Types of fault movement  
(after Krinitsky, 1974).

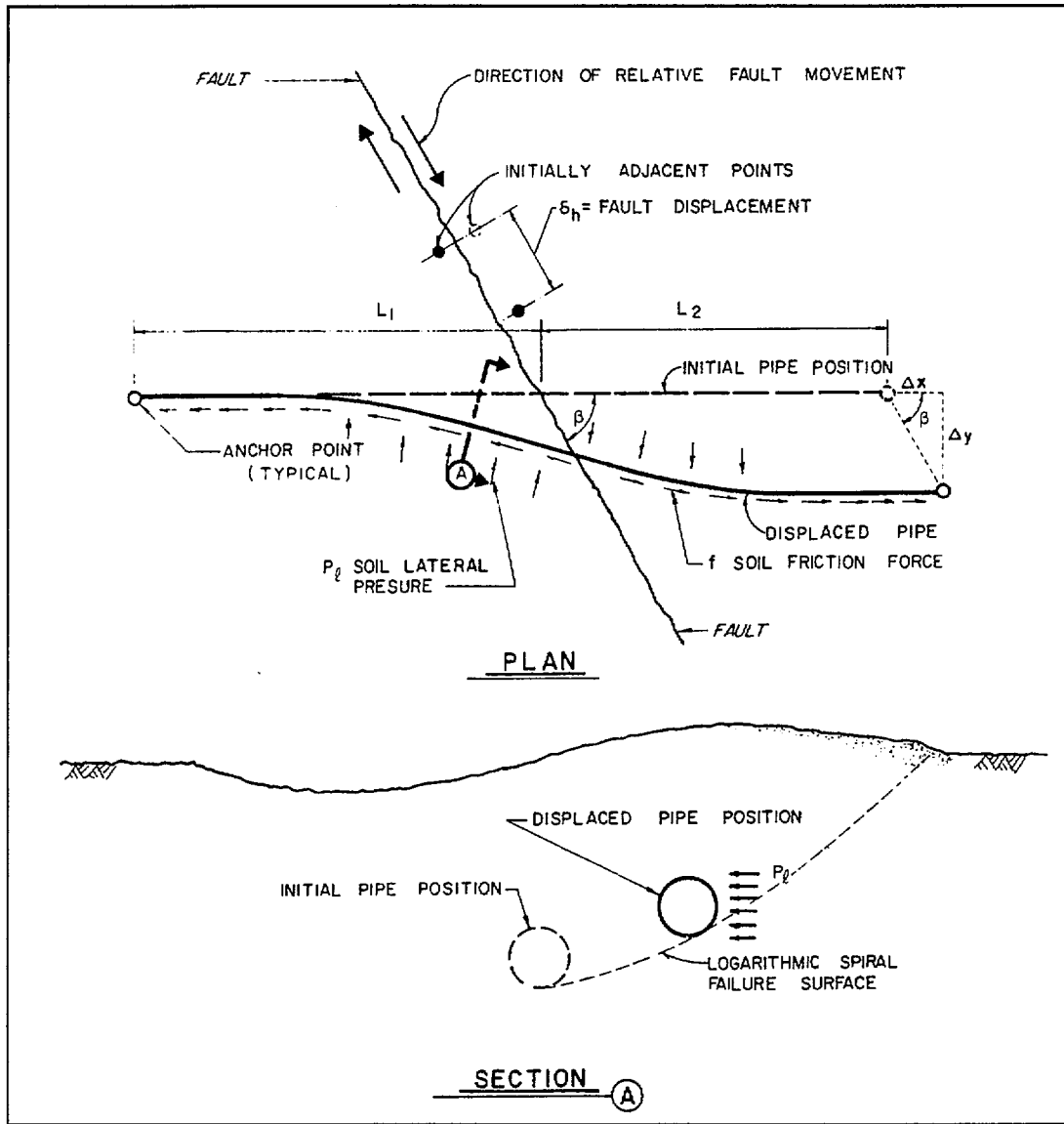


Figure 5. Movement of shallow buried pipeline subjected to strike-slip fault displacement (after Kennedy et al., 1977).

RECOMMENDATIONS FOR LIFELINE SEISMIC STANDARDS

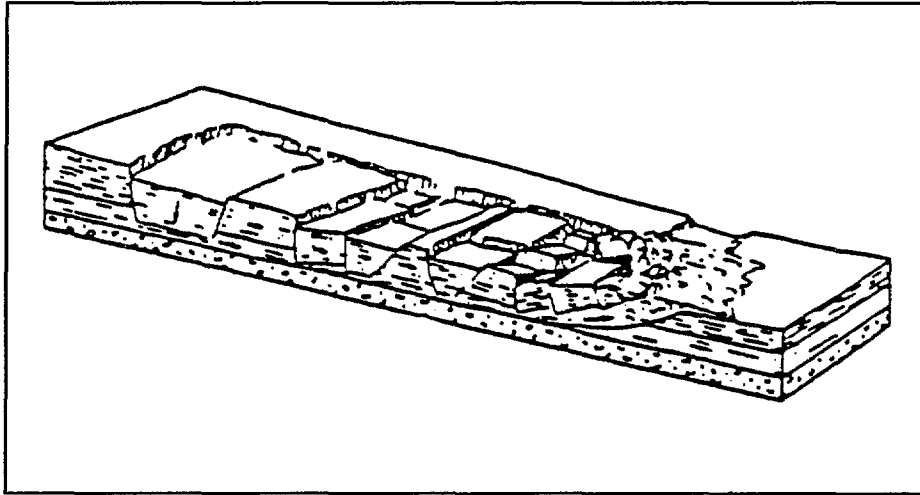


Figure 6. Lateral spread ground displacement  
(after Schuster and Fleming, 1982).

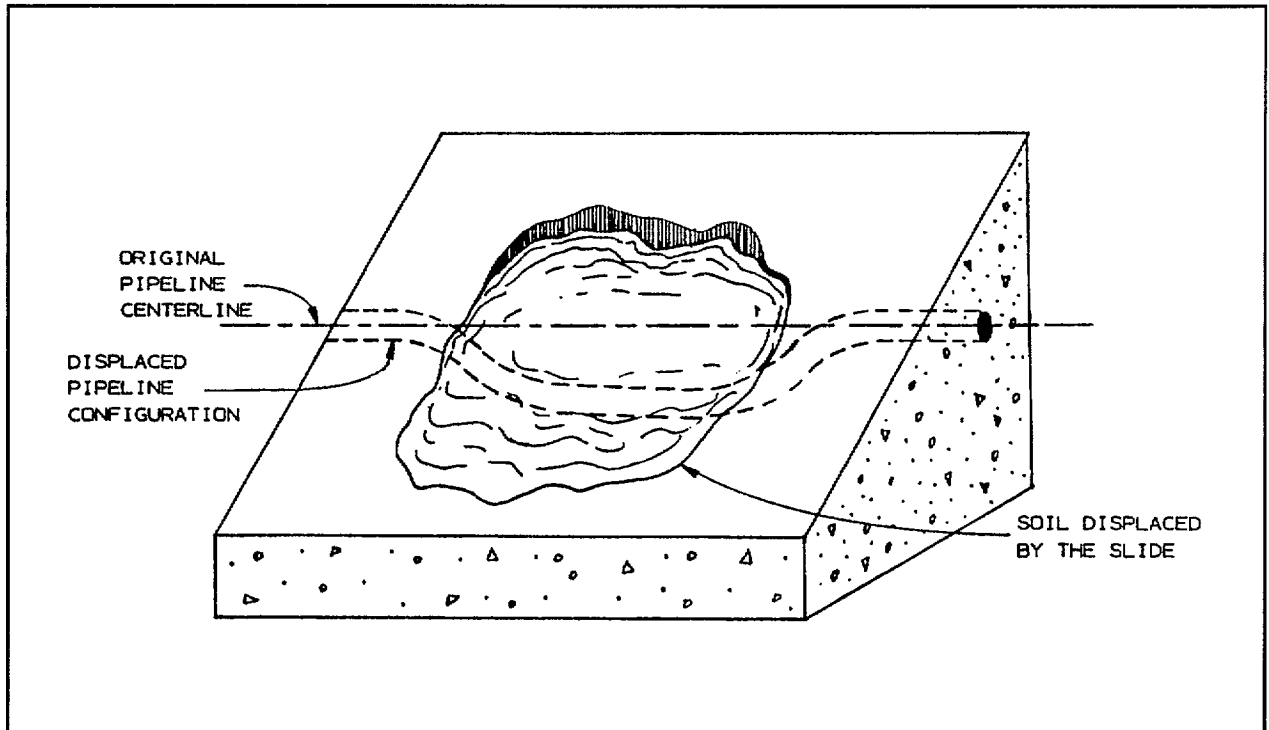


Figure 7. Landslide effect on buried pipeline.

RECOMMENDATIONS FOR LIFELINE SEISMIC STANDARDS

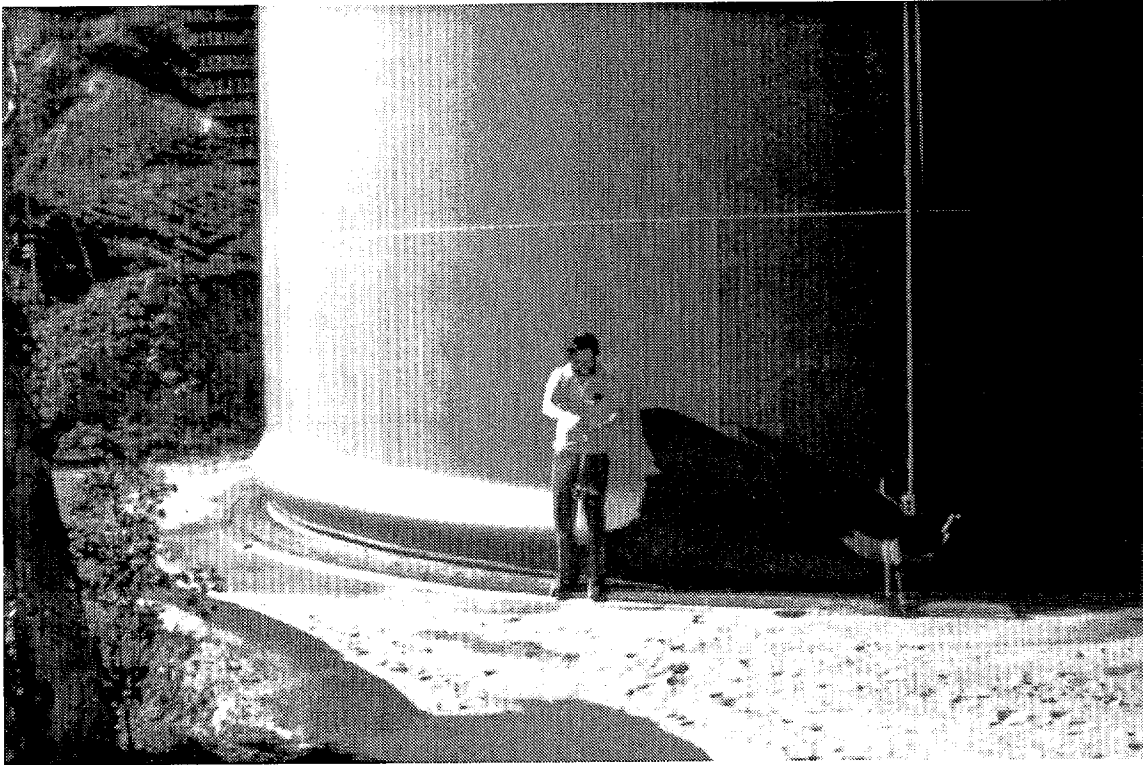


Figure 8. Circumferential buckle in water tank, Olive View Hospital, 1971 San Fernando Earthquake.





Figure 9. Example of earthquake non-structural damage.

RECOMMENDATIONS FOR LIFELINE SEISMIC STANDARDS



Figure 10. Buckled steel gas pipeline, 1971 San Fernando Earthquake  
(Photo courtesy Southern California Gas Company).

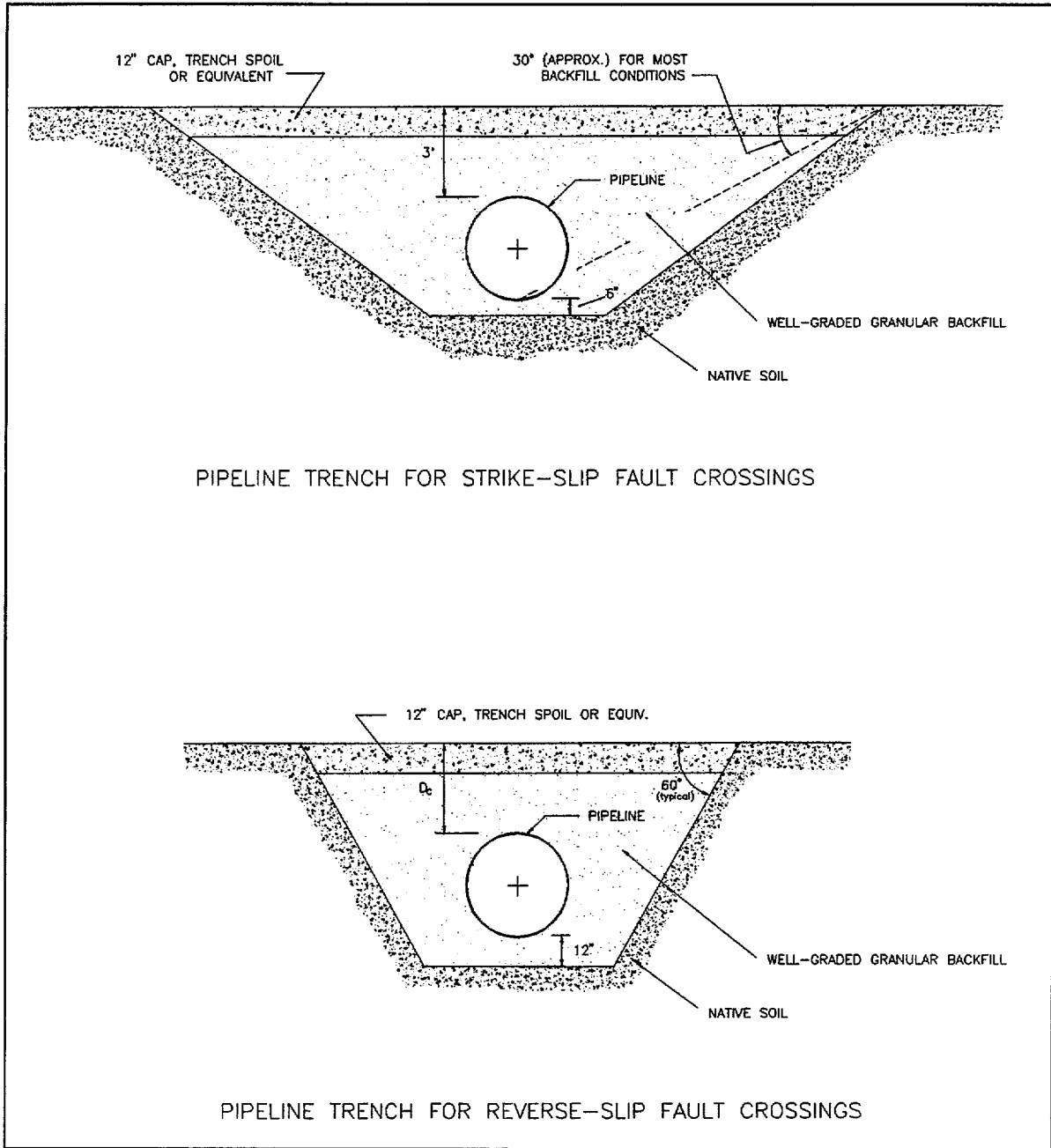


Figure 11. Pipeline trench design for fault crossings.



---

## CHAPTER IV: TELECOMMUNICATION LIFELINES

*ALEX TANG*

---

### IV-1. GENERAL

The purpose of this plan is to reduce the potential for loss of telecommunication service after damaging earthquakes, which is a vital part of coordinating and executing lifesaving actions. Suggested actions to reduce the potential for loss are:

- Improve design
- Use better material
- Analyze and upgrade existing installations
- Provide dispersed redundancy

Telecommunication systems are damaged by earthquakes. Photo 1 shows damage to the Sylmar central office (CO) in the 1971 San Fernando earthquake. The severity of damage ranges from collapsed central office buildings and overturned equipment to minor repairable damage to cable handling systems and equipment/component mounting racks, such as battery racks.

Damage mitigation of telecommunication systems should be prioritized as follows:

- **Priority 1**--Loss of life: equipment overturned, building collapsed
- **Priority 2**--Public security: fire, rescue dispatch, police, and governmental communication (national security)
- **Priority 3**--Economic impact: loss of business transaction, banking

The operability of the telecommunication lifeline functions is the primary focus.

The seismic performance of telecommunication systems since the 1971 San Fernando earthquake has improved significantly in the West Coast regions. However, the central regions and eastern states are not as well prepared. Furthermore, growing competition and advanced technology are setting a trend towards cost-cutting measures and concentration, and these factors may affect the future performance of the network.

The standards to be developed will be used to improve the design of new facilities, upgrade existing installations, advance the use of new engineering materials, enhance network redundancy, and impose and maintain consistency in industrial practices. The end result is more robust equipment and system performance during an earthquake, and improved service reliability and operability in general.

#### IV-1.1 Telecommunication Systems

The three main functional elements of telecommunication systems are:

- Switching
- Transmission

## RECOMMENDATIONS FOR LIFELINE SEISMIC STANDARDS

- Signaling (call supervision)

Switching is the part of the telecommunication system engineered to connect two or more parties. Transmission is the part of the telecommunication system concerned with transmitting messages between calling and called parties, while signaling is the part of the telecommunication system designed to supervise the call, including ringing, confirmation, disconnect, and restore trunk line to open status (called *sign-off*).

The physical components/facilities constructed to operate these functions can be divided into two categories: switching facilities and outside transport facilities.

Switching facilities, commonly known as central offices, include all, or a combination, of the following: cable entry, cable distribution, and power supply systems; switching, transmission, and data processing equipment; and support facilities. Support facilities include HVAC (heating, ventilation, and air conditioning), AC (alternating current) power distribution, fire suppression, backup generator (emergency power), spare parts storage, and the structure housing the equipment.

Outside transport facilities (Figure 1) include loop/trunk distribution (buried and aerial), microwave and radio transmission towers, and repeater station facilities. Loop refers to the cables connecting a subscriber with the switching facilities, while trunk is the term for cables connecting switching facilities.

Network services and management associated with telecommunication systems will be addressed in this plan. Network services and management include 911, Centrex, ISDN (Integrated Services Data Network), CCS (common channel signaling) with SS#7 (Signal System #7), STP (switch transfer point), essential services, and network interoperability.

There are three networks in the telecommunication systems in North America. They are the Public Switched Network (PSN), the Private Exchange Network (PXN), and the Wireless Network (WN).

The Public Switched Network in North America is the largest communication network in the world. About 50 percent of this network is owned by seven regional holding companies (RHC) in the United States, including the following:

- **Ameritech**--Wisconsin Bell, Michigan Bell, Illinois Bell, Indiana Bell, and Ohio Bell
- **Bell Atlantic**--Bell of Pennsylvania, New Jersey Bell, and Chesapeake and Potomac
- **Bell South**--Southern Bell and South Central Bell
- **NYNEX**--New York Tel, New England Tel, and South New England Telephone
- **Pacific Telesis**--Pacific Bell and Nevada Bell
- **South Western Bell Corp.**--South Western Bell
- **U.S. West**--Pacific Northwest Bell, Mountain Bell, and Northwestern Bell

The remaining portion of the regional network is owned by independent companies, such as Gen Tel (General Telephone) and Cont Tel (Continental Telephone), and long-haul carriers, including AT&T (American Telephone & Telegraph), MCI, and U.S. Sprint.

The implementation of wireless technology in the PSN has created a cellular network, which is also known as a wireless network (WN). This network can be considered an expansion or extension of the land lines. So far, the cellular network concentrates in major cities. The cellular network provides additional dispersion and redundancy. Figure 2 shows the concept of the wireless network. Note that the connections to nonwireless subscribers are through central offices (COs) that are already in place. This will add to the overload conditions that happen every time there is an emergency.

Large organizations such as banks, universities, government agencies, and public utilities use a miniature version of the PSN called PXN (Private Exchange Network). Usually a large PXN consists of a host office, which is the primary switching center, and a number of remote offices, which serve the employees in the organization. For most PXNs, the host office is connected to the PSN via a single trunk to a class 5 end central office of a local telephone company.

Trunking<sup>1</sup> between the different classes of central offices was developed based on a hierarchical structure of central offices. Central offices for the PSN are classified as follows:

- Class 1--Regional center
- Class 2--Sectional center
- Class 3--Primary center
- Class 4--Toll center
- Class 5--End office

Classes 1 to 3 are control switching points (CSPs). Calls are connected based on the above hierarchy. For instance, a call designated to the West Coast from the East Coast of North America will start from a class 5 office on the East Coast and go up the hierarchy and then back down to a class 5 office on the West Coast to complete the call. The capacity of the links between central offices depends on the traffic pattern between the central offices. As communities grow, the demand for greater capacity drives the increase in the number of trunks between central offices. For example, when the traffic going to a specific class 4 CO increases to a point that a new trunk is required, a high-usage trunk, as shown in Figure 3 with a dotted line, will be created.

The current number of central offices in the United States and Canada is shown in Figure 4.

The number of class 5 offices, which are usually called end (central) offices, is growing at a fast pace due to an increase in demand for services. Most homes have more than one phone line now, or two phone numbers on one line, and all subscribers are connected to the end (central) offices. End (central) offices of different exchanges are sometimes connected by trunks (called local trunks). These exchanges are in the same rate zone; therefore, there are no long-distance charges.

Figure 5 shows a typical network and some possible interconnections. Assuming that COs A, B, C, and D are in the same rate zone, for a call from A to D there will be no long-distance charges if

---

<sup>1</sup>The introduction of microwave transmission increases the pace and ease of trunk deployment in the network.

## RECOMMENDATIONS FOR LIFELINE SEISMIC STANDARDS

the local trunks are busy and the toll trunk is used to connect calls.

The hierarchy described above is gradually flattening due to divestiture and the capability of the digital switching equipment. Eventually, the hierarchy of central offices will be reduced to end (central) offices, toll (central) offices (including tandem offices<sup>2</sup>), and STPs (switch transfer points).

### IV-1.2 Scope

Telecommunication systems will be reviewed in the three categories described earlier:

- Public Switched Network (PSN)
- Private Exchange Network (PXN)
- Wireless Network (WN)

The Public Switched Network is mostly provided by Bell Operating Companies (BOCs). This is the basic communication system for subscribers. The long-distance carriers are part of this network.

The Private Exchange Network includes private exchanges (PBX) for utilities, government, hospitals, airports, military, banks, and large organizations.

The Wireless Network includes cellular radio, ham radio, and emergency services. Emergency services, such as police and fire departments and ambulance and paramedic services, have their own radio systems, which operate on an assigned frequency band. The equipment and components used in all these networks are similar in size and construction.

In addition to active and passive equipment seismic protection, network management and special services will be covered.

### IV-1.3 Philosophy

Operability and functionality are the prime objectives of lifelines. In general, failure of lifelines will not directly result in loss of life, as would failure of a structure. Lifelines are an integral part of modern urban living. They are expected to be available whenever they are needed. A short disruption of services causes inconveniences, while a prolonged disruption can cause significant economic losses, deteriorated sanitary conditions, and health problems. Therefore, the standards for lifelines consist of performance standards and prescriptive standards. The prescriptive standards are designed to meet the performance criteria established in the performance standards, that is, performance standards set criteria while prescriptive standards provide engineering guidelines for constructions, installations, and material usages. Standards for new construction and for existing construction should meet the same performance criteria. The level of repairable or restorable damage, without impacting the system performance criteria, may differ. The intent is to reduce the financial impact on upgrading/retrofitting.

It is important to establish the zoning and the ground motion data since these are the basis for the development of standards. Seismic zoning maps for the United States are available from various sources. The commonly used ones are the UBC (Uniform Building Code) zoning map, the

---

<sup>2</sup>A tandem office is a switching office for trunks.



FEMA 95 (NEHRP Recommended Provisions for the Development of Seismic Regulations for New Buildings) zoning map, and the NEBS (Network Equipment Building System) zoning map. The latter is used by most BOCs. NEBS is a specification for telecommunication equipment, which is designated for PSN. Another approach is to combine the zones into two classes of seismic severity for the whole nation, for example, class A for high seismic areas and class B for the remainder. This is the approach (T1Y1.4 SWG3) an ANSI committee is going to apply to the standard for telecommunication equipment.

#### **IV-1.3.1 Policy**

The goal of establishing standards and codes is to provide uniformity in telecommunication systems to ensure operability of the basic service (POTS, plain old telephone service), that is, connecting a caller to the called party, during and after earthquakes. The primary performance criterion of the telecommunication systems is to provide uninterrupted telecommunication services. Educating the public, increasing available circuits, increasing call-handling capability (through network management), and providing state-of-the-art seismic protections for all equipment in the network are necessary steps to achieve the goal.

#### **IV-1.3.2 System Design**

While the system is in existence, new components are constantly being added to expand the system capacity and the network, and out-of-date or worn-out components are being replaced. It is, therefore, not practical to demand compliance with new standards and codes for all existing facilities. Retrofits/upgrades are expensive and the need for them must be evaluated separately. On the other hand, prioritizing the systems' postearthquake performance is essential in order to establish a plan for standards. Services in order of priority include:

- Uninterrupted services for essential services, such as fire and police departments, emergency response, and medical services
- Protection of critical facilities of the network
- Overall uninterrupted services

The intent is to balance practicality with an acceptable level of risk for what is out there.

The approach to ensure a timely implementation of the standards and codes is to mandate all new installations/constructions to meet the standards and codes. Then, in parallel to this action, existing facilities should be upgraded to the risk accepted by standards and codes for existing facilities according to the priority established. A time limit should also be established for completing the upgrade activities to ensure system level performance by a certain target time.

The standards and codes should be applicable to telecommunication systems defined in Section 1.1.

#### **IV-1.3.3 Component Design**

The components considered in telecommunication systems are:

- Buildings (including underground vaults, control environment vaults (CEV)
- Underground conduits and manholes

## RECOMMENDATIONS FOR LIFELINE SEISMIC STANDARDS

- Transceiver towers and poles

Specific application standards for component designs do exist. These standards by and large should be descriptive. Usually, they are the minimum requirements for their specific application. However, the standards and codes to be developed for telecommunication systems component designs have to be more stringent. This can be achieved by using an importance factor, or a factor for critical element in determining the design requirements.

### IV-1.3.3.1 Buildings

Telecommunication facilities are critical facilities. Therefore, the structures housing the equipment should meet a higher standard than that of ordinary buildings. The floor loading in general will exceed that for ordinary buildings. For example, the floors are required to support equipment, cable, and ironwork, requiring stronger construction.

The cable entry design portion of the building should be incorporated into the standard. Considerations of relative displacement of the building and the ground is an important factor. Severance of cables as a result of this relative displacement is common in large earthquakes.

Expanding on the current UBC by adding a section (chapter) on lifelines equipment (critical services) buildings is a logical approach. Lifelines equipment buildings can be broadly defined as buildings that house equipment for the operation of lifelines. FEMA's NEHRP Recommended Provisions for the Development of Seismic Regulations for New Buildings will be extremely helpful if adopted.

Methods for retrofitting are also available. These methods can be documented as a design guide for existing structures. Seismic rehabilitation methods such as strengthening (e.g., additional shear walls) and load reduction (e.g., base isolation) are being used to upgrade structures constructed under old codes.

### IV-1.3.3.2 Underground Conduits And Manholes

The development of standards for underground conduits could be facilitated by information from buried liquid fuel pipelines and buried water and sewage pipelines research and development, studies, and practical data. The mechanics of failure, methods of damage mitigation, and material performance from the buried pipelines studies are useful for estimating the response of the underground conduits in a wide variety of site conditions.

State-of-the-art research and development work on conduits and manholes conducted at Tsukuba Telecommunication Construction Engineering Development Center in Japan could be quite helpful. Attempts should be made via workshops to facilitate technology exchanges. If made available, NTT (Nippon Telegraph and Telephone) standards for outside plant constructions related to seismic damage mitigation can provide a good baseline for this endeavor. Further research would be required, however, to provide a proper fit of the information and data to North America conditions.

Liquefaction around a manhole can cause severe damage to the cable entering and exiting the manhole. Design criteria and site preparation standards for liquefiable soil have to be established to prevent damage to underground cable.

Fibre optic cables are starting to gain ground on copper cables in trunk installations. The

performance of fibre optic cables in underground conduits requires more study. In general, fibre optics are less robust than copper, which can take a fair amount of abuse. Again, research and development results from Tsukuba Telecommunication Construction Engineering Development Center could provide helpful data to speed up development of standards.

There is a limited number of above-ground routing of fibre optic cables. Usually, these cables are run inside a conduit, metal or plastic. However, there are cases in which unprotected fibre optic cables are run along a railway. Standards to be developed can eliminate this type of hazardous situation.

#### **IV-1.3.3.3 Transceiver Towers And Aerial Cable Poles**

There are two types of transceiver towers: the guided and the nonguided. The towers can be located on the roofs of switching facilities, on grades next to the switching facilities, and on high grounds, such as hill-tops, in the proximity of a repeater station.

In most cases, the towers are equipped with transmission and receiving dishes and antennae. The rapid deployment of wireless communication in major commercial centers created by the market generated the demand for more transceiver towers. Each cell of the wireless communication network requires a transceiver tower to provide service within the cell. The largest cell has a radius of about 15 km. In high-traffic areas the cells are much smaller. Each cell is served by a transceiver tower.

Towers are usually designed to resist wind and ice load, which is considered by many to be adequate for seismic application. However, towers have been damaged by earthquakes. Furthermore, dishes and antennae are added to the same tower, which may be constructed without consideration of the additional load.

In the absence of data and information on transceiver tower performance, a study is necessary to establish a prescriptive standard by analyzing performance data and tower design for seismic applications. The current standards and codes for tower construction are inadequate to handle the seismic requirements. In some cases, older designs may even be marginal in resisting wind loads. Low-cost methods for strengthening existing critical towers are necessary to achieve an acceptable level of protection. Aerial cable poles are in the same category as the transceiver towers. The standard to be developed should cover this item.

#### **V-1.3.4 Equipment And Material Provisions**

Two categories of equipment will be discussed in this section: active and passive. Active equipment can be defined as equipment performing a particular function of operation. Active equipment in switching facilities includes switching, transmission, data processing, cell-site, radio, and power supply equipment, including power board, rectifier, inverter, and battery racks. Passive equipment can be defined as equipment providing support to active equipment. Passive equipment includes the cable distribution system, the MDF (main distribution frame), and the power bus bars in power supply. The cable distribution system has a few other names: ironworks, auxiliary frame, and superstructure. This does not imply any distinction in importance of the equipment. Failure to any one of the two categories of equipment affects the performance of the system. Therefore, standards should cover all active and passive equipment.

Generic equipment design criteria to meet state-of-the-art earthquake protection requirements do exist; they are the Bellcore (Bell Communications Research), TR-000036 issue 3 and FEMA 95,

## RECOMMENDATIONS FOR LIFELINE SEISMIC STANDARDS

NEHRP Recommended Provisions for the Development of Seismic Regulations for New Buildings. Both specifications cover all in-building equipment installations, but the methods and approaches used are different. A comprehensive standard can be achieved by extracting good approaches from the two specifications.

There are as many variations of installations of the cable distribution system as mechanical parts of various sizes, materials, and geometry used in the cable distribution system. This equipment should have standard configurations plus design guidelines for practical application.

MDF is a very simple structure for cable termination in central offices. Trunks from the outside plant facilities are connected on the vertical side of the MDF, while the switching equipment is connected to the horizontal side. This framework consists of an upright piece of steel with horizontal short pieces of steel either welded or bolted to the upright at 30-mm intervals. Photo 2 shows a typical MDF in a central office.

For the cable distribution system, design and installation guidelines can be developed to eliminate the impact of missing bracing and to avoid overloading by cable and overhead bracing of equipment. Tests can be performed to establish the baseline for the design guidelines. Design details of the parts used in the system can also be improved from the test results.

Support facilities, such as HVAC, fire suppression systems, spare parts storage facilities, backup generator, AC distribution systems, and accessories, should have their own standards of practice. The standards for HVAC should include ducting, cooling water supply requirements, backup power, and the fan unit. For spare parts storage facilities, the active equipment standards can be applied for critical spare parts. A standard practice design guideline is an appropriate approach. Standards for accessories, such as desk-top terminals and keyboards, printers, oscilloscopes, and test equipment, can be established using the same approach.

Fire-suppression systems are governed by building codes, but the specific requirements for switching facilities should be evaluated. PSN facilities in general do not use central fire-suppression systems. Damage caused by these systems may be far more extensive than the fire itself. Materials used in PSN facilities have to meet UL (Underwriters Laboratories, Inc.) flammability specifications. However, when PSN facilities share a building with other tenants, the fire-suppression system is required by the building code.

## IV-2. SWITCHING FACILITIES

### IV-2.1 Introduction

Switching facilities are commonly known as central offices. Central offices (COs) with specific functions have different names: DLC (digital loop carrier), CDO (community dial office), CEV (control environment vault), and toll offices, just to name a few. Large communities may be served by large class 5 offices for up to 30K lines each.\* Smaller communities may be served by remote switching facilities or digital loop systems housed in small buildings, CEVs, or huts.

The buildings for these facilities vary from single-story structures to multistory high-rises. For multistory central office buildings, it is not uncommon to have a few floors of switching and transmission equipment performing different classes of functions. For example, the first and

---

\*See discussion of classes of offices on page IV-3.

second floor can be class 5 end offices, the third floor can be a toll office, and the fourth floor can be a tandem office. Some of these buildings were built for central office purposes, and they can easily be identified, since most of them are windowless with very high ceilings. The windowless structure provides added strength. The cost to construct this type of building is high. In today's competitive environment when economics takes precedence, ordinary commercial buildings are used for central offices operations.

Large private exchange systems, such as those used by large universities, military bases, banks, utilities, and large private and public organizations, can be as large as a small central office. A 6,000- to 7,000-line system is quite common. These systems usually consist of a host office and several remote centers. Sometimes, these systems are installed in buildings that cost much less than the equipment. In many cases, these buildings, some barely meeting code requirements, may have been converted to house this equipment. The host office can be considered as a class 4 office in the public network hierarchy, while the remote centers are class 5 offices. These PXN systems are connected to the PSN via a single CO trunk. The whole PXN can be cut off from the PSN if this trunk is severed.

Each central office can be considered as a node in the network with branches (trunks) connecting to other nodes. For a multistory central office building with different classes of offices on different floors, the node contains subsets of nodes. These are the most critical nodes in the network. Large private exchange systems can be represented by a subnetwork with a branch from the host node to a central office where the trunk is connected.

## **IV-2.2 State Of The Art**

There is a big difference in outcome between evaluation of vulnerability and risk. Evaluation of risk provides (1) the probability of sustaining a given level of loss and (2) a quantifiable answer to determine the level of seismic damage mitigation. Evaluation of vulnerability determines design and installation deficiencies.

### **IV-2.2.1 Vulnerability**

For switching facilities, evaluation of vulnerability can be divided into five areas:

- Site evaluation
- Equipment evaluation
- Support facilities evaluation
- Cable distribution system evaluation
- Structural and architectural elements evaluation

#### **IV-2.2.1.1 Site Evaluation**

Depending on the geographical location of the building, a switch facility can be exposed to seismic hazards, such as landslide, liquefaction, lateral spreading, subsidence, and soil amplification. All of these hazards can cause differential displacement between building and ground, which can sever cables that enter/exit the facility. The seismic-prone areas in the central United States are susceptible to these types of seismic hazards.

## RECOMMENDATIONS FOR LIFELINE SEISMIC STANDARDS

### IV-2.2.1.2 Equipment Evaluation

Evaluation of equipment can be divided into five groups:

- Equipment support structure
- Equipment anchorage
- Overhead bracing details
- Methods of securing components
- Methods of installation

Analysis of design details of the structural elements of equipment racks, cabinets, and frames can provide definitive answers of the structural capability to resist seismic force. Trained individuals involved in the structural design of equipment can differentiate a good design from a marginal or poor one without spending a lot of time in analysis.

Unanchored equipment is subject to the hazard of toppling and resultant damage in earthquakes. Photo 3 shows a piece of unanchored equipment overturned in the 1989 Loma Prieta earthquake. It is important to ensure that all equipment in a switching facility is adequately anchored. Information on anchor sizes and types and on concrete strength is essential for a proper analysis.

A substantial amount of equipment in central offices in high seismic zones is overhead braced. The details of the overhead bracing design are important to satisfy the design intent. Friction connections, bracing to nonstructural elements with inadequate anchorage of bracing elements, are vulnerable. Photo 4 shows a damaged cable rack during the Whittier Narrow earthquake in 1987.

For switching and transmission equipment, the methods of mounting shelves on racks, frames, or cabinets is important. Vibration caused by in-building motion during earthquakes can result in the dislocating or loosening of mounting hardware. Shelves can drop from their mounting surfaces. For example, a shelf with open slots on the mounting flange will slide off the mounting screws due to frame spread. Securing components to the shelves is also important. Whether it is a mechanical device or a printed circuit board, proper mechanical securing methods should be used to prevent the device or circuit board from walking out of a slot in a shelf.

Accessories used in switching facilities are terminals and keyboards, printers, test equipment, reference manuals, and tapes/diskettes. Terminals in these facilities are used to monitor the system and, if they are not secured on the desks, they can end up on the floor during an earthquake. This will create difficulties in tracking and analyzing problems after an earthquake. There are a number of practical means of securing these types of accessories. Velcro™ can be used, and it is a very low-cost method. The same method can be used for retaining reference manuals and tapes on shelves.

Batteries sitting on shelves without ties or rails to prevent them from falling or walking off the shelves are exposed to seismic hazards. Photo 7 shows a poor engineering/installation practice, and Photo 8 shows damage as a result of this type of poor practice. The rack may remain undamaged while the batteries are rendered nonfunctional. Evaluation of strength and anchorage requirements for batteries should follow the same processes as for equipment.

In switching facilities, equipment of the same manufacturer is usually installed together to form a lineup of equipment. Unless the frames are joined mechanically, they are vulnerable to impact damage due to out-of-phase motion. Unanchored storage cabinets or shelves that are not

essential parts of the operation of the facility should be at least 1.5 times their height away from the nearest operational equipment.

#### **IV-2.2.1.3 Support Facilities Evaluation**

As previously defined, these facilities include:

- Power supply
- Backup generator
- HVAC
- Fire-suppression systems
- Elevator
- A/C distribution
- Spare parts storage structures

Power outages have occurred in earthquakes, and the switching facilities are not exempted from power outage. Power reserves from batteries and backup generators are vital to maintain the facility's operability. Traditionally, telecommunication systems are required to provide power reserves for a period of time specified by the purchaser. In general, the reserves range from four to eight hours. If the commercial power is not restored before the specific time limit, the batteries will discharge to the point that the polarities can reverse. At that point the equipment will either malfunction or be damaged by the reverse current. It is desirable to have a functional backup generator to supply power before the discharge occurs. If a backup generator is damaged, a mobile unit can be brought in within the power reserve period to provide power for the equipment. For a large event that affects a wide area and reduces access to the switching facility, a functional backup generator is a must. The Loma Prieta earthquake provided valuable information regarding backup generators; properly maintained generators and well-trained staff are necessary.

Elements in generators that are vulnerable to damage are fuel lines, governors, vibration isolation pads, radiators, fuel tanks, and starter equipment, including pressure tanks, batteries, and air lines.

Switching and transmission equipment are powered by DC (direct current); power boards, rectifiers, and inverters are used to provide regulated DC to the equipment as well as to charge the batteries. There are three commonly used DC voltages in switching facilities; they are -48V, 24V, and 130V. In general, the construction of power equipment is similar to the switching and transmission equipment, and the same approaches used in equipment evaluation can be applied. The securing and isolation of power buses have to be evaluated. A short between the power buses caused by isolation breakage or dislocated mounting hardware can cut off power to the equipment and may cause fire.

Most of the HVAC units in service in switching facilities today have not been designed adequately for seismic application. The high-technology equipment being deployed in switching facilities today requires cooling to ensure proper reliability of operation. Cooling is becoming an essential part of the switching and transmission equipment. High ambient temperature will reduce the reliability of the integrated circuits used in digital equipment. The network will also be relying on data-based operations, using data processing equipment that also requires cooling. Most of the cooling units are the water-cooled type. The pipelines and water source are vulnerable to seismic hazards if they are not provided with flexible joints. Most HVAC units are not designed to be operational during and after earthquakes. HVAC seismic design is necessary now.

## RECOMMENDATIONS FOR LIFELINE SEISMIC STANDARDS

Equipment facilities with sprinkler systems for fire suppression can cause extensive damage to equipment when the pipes are severed by an earthquake. Therefore, water pipelines servicing the central offices in general can cause extensive damage.

Regulations currently require equipment facilities in shared commercial buildings to be equipped with a fire-suppression system. This requirement should be carefully reviewed. The damage caused by broken sprinkler pipes, if a water sprinkler system is used, is far more severe than earthquake damage. Water pipelines bracing and methods of securing are important. The discharge of a halon gas fire-suppression system can cause long-term damage to the printed circuit-board circuits.

It will also suffocate people if they are in the enclosed area when the gas is released. A broken valve can be life threatening. Proper protection of the halon discharge unit against seismic hazards is required. This is an area worth investigating. Design guidelines can be made available to the industry.

Elevators are used mainly for restoration after damage. An operating elevator after an earthquake will ensure speedy restoration of heavy equipment to the upper floors. However, this is not considered to be important enough to set a standard for the telecommunication system.

AC power distribution panels and breaker panels are potential problem areas. The anchorage for these panels may not be adequate. AC power cables are routed throughout the central office with rigid metal conduits, without flexible joints. They are highly vulnerable to damage. A damaged panel can cause a host of problems such as fire. Photo 5 shows a damaged AC panel in the 1989 Loma Prieta earthquake.

There is a common tendency to use substandard buildings for spare parts storage. Damage to these buildings will definitely affect the restoration effort and increase duration of recovery after damaging earthquakes.

### **IV-2.2.1.4 Cable Distribution System Evaluation**

This system includes the evaluation of ironworks and the main distribution frame (MDF). Cable entry from the outside plant arrives at the vertical side of the MDF. Routing of internal cabling from MDF to switching and transmission equipment is carried out by cable racks secured on the ironworks.

The MDF is a fairly flexible framework. It is always supported overhead. For seismic installations extra steel angles are used to brace the MDF to the ironworks. The configurations of bracing vary as much as the ironworks itself. The methods of securing the bracing components in most cases are not adequate. This equipment is not likely to be replaced regardless of the progress made in the switching and transmission equipment. The framework is vulnerable to damage, such as bent or buckled uprights, loose terminal blocks, broken wire leads, and slipped or broken brace joints to the ironworks.

There are design guidelines that govern the installation of the ironworks. These were developed for nonearthquake applications. However, there are as many different mechanical parts used in the ironworks as there are variations of installations from the design guidelines. The guidelines fail to address the physical restrictions of each site. Bracing requirements were added to enhance the strength of the system for earthquake applications. Non-Bell telephone companies have their



own set of guidelines for the ironworks. Most of them are based on the original Bell System Practices (BSP).

The systems that exist today still extensively employ friction clip splices for cable racks. This is a recognized deficiency, and while the risks to system integrity may be limited, the risks do exist.

In some old buildings, the anchors used for supporting the system are cast-in-place cast-iron anchors. They are quite brittle, and most of them cracked under seismic load. Photo 6 shows ironworks damaged by the Whittier Narrows earthquake in 1987.

Like the MDF, this system will exist for at least another 10 to 20 years before the full deployment of fibre optic cables in switching facilities, which has started. This is an exposure to seismic hazard.

#### **IV-2.2.1.5 Structural And Architectural (Nonstructural) Elements Evaluation**

This category includes building structures, raised floors, dividing walls, light fixtures, and ceiling panels.

Divestiture created competition, and building structures dedicated for central offices usage are no longer the trend. The tendency is toward leasing or purchasing commercial buildings. Since the buildings were not designed for housing vital equipment, most of them were built to minimum code requirements. There is a need to assess these buildings.

Recently, some owners in high seismic areas have initiated building surveys and assessment of adequacy of their buildings to resist seismic force.<sup>3</sup> Some buildings have been reinforced. Building upgrade is one of the highest priorities.

Raised floor application is starting to make inroads into the central office environment. For private networks, most of the installations are on raised floors. Different methods have been used to provide seismic protection. Some of the methods used are side-posts, braced raised floor pedestals, and structural pedestals for equipment. The trend toward using raised floors is driven by the new technology. Photo 9 shows equipment on a structural pedestal for raised floor application.

Commercially available raised floors in general are not designed to resist lateral force transmitted from the equipment. Displacement due to shaking is the main concern for equipment anchored to the concrete slab through the raised floor. The trend is toward structural pedestals with raised floor built around the equipment lineups.

Most nonstructural elements are installed to the minimum requirements that apply to noncritical facilities. Special considerations are necessary for switching facilities. Fallen ceiling panels and light fixtures can cause service interruption.

#### **IV-2.2.2 Current Practices**

Since the industry is no longer regulated, competition dominates most planning and investment decisions. There are no standards governing all telecommunication systems. An important lesson

---

<sup>3</sup>Private communication with Mr. Larry Wong of Pacific Bell.

## RECOMMENDATIONS FOR LIFELINE SEISMIC STANDARDS

here is that although a competent level of engineering to mitigate damage is feasible and achievable, the lack of demand and requirement has kept the industry from reaching that level.

For equipment protection, planners and purchasing agents are specifying seismic protection as a requirement. Bellcore and Applied Technology Council (ATC) specifications are used for this purpose. New products are required by BOCs to meet seismic requirements specified in NEBS. However, non-Bell companies are not following this practice. Some require that the equipment meet NEBS, but the same cannot be said for its installation (e.g., reducing anchor size or number of anchors to accommodate floor deficiencies).

For building structures, the trend is toward leasing buildings or portions of a building for equipment. Hence, earthquake protection in most cases is an afterthought.

Another development is that in the central and eastern United States, earthquakes have only recently become an issue. Some upgrading is in progress, but the work is sporadic.

Techniques are available to upgrade equipment, and design guidelines are available to prevent seismic damage. Following is a list of some of the techniques and guidelines in use today:

- **Anchor Equipment Securely**--Anchorage is a basic requirement and most essential for telecommunication equipment; it is essential for the protection of any lifeline-related equipment. The classical action-reaction diagram in Figure 6 shows why anchorage is needed to resist lateral loads.
- **Tie Side-By-Side Equipment**--Pieces of equipment located side by side should be tied together; a through-bolt or a metal plate can be used to form a mechanical junction of the tops of the equipment frames. This prevents out-of-phase pounding, which can severely damage the frames and, hence, the components and shelves mounted on the frames.
- **Allow Sufficient Spacing For Relative Displacement** -- Where interequipment ties are not practical, leave enough space between pieces of equipment to allow for relative displacement. The spacing is governed by the stiffness of the equipment. There should also be adequate spacing between equipment and structural members of the building. In general, it is good practice to allow extra spacing to ensure safety.
- **Build in Cable Slack To Relieve Cable Strain**--Cable slack will prevent cable damage due to stretching. Copper cable is reasonably robust in this regard, but the seismic load on copper cable should not be underestimated. The extra cost of cable slack is very inexpensive insurance against cable failure.

It is also a good engineering practice to provide cable restraint at exit or entry points between equipment or lineups. This will provide a second level of protection for seismic loads, and day-to-day protection for maintenance and service.

Fibre optic cables, although not as robust as copper cables, are treated in the same manner as described above. However, the fibre optic cables are run separately and are not mixed with copper cables.

- **Install Positive Locking Connectors And Circuit Packs**--A positively

locking connector can prevent loosening due to vibration or cable pulling. A lock latch or a retaining bar across the front of the shelf can prevent circuit packs from walking out of connections.

- **Avoid Top-Heavy Design**--Top-heavy equipment has a high center of gravity and a large moment due to seismic force. The moment puts extra load on the anchors and the structural portion of the equipment base.
- **Avoid Open-Ended Slots For Equipment Shelf (Figure 7)**--Open-ended slots can cause shelves to be dislocated from mounting hardware during an earthquake.
- **Use External Bracing**--External bracing of equipment is necessary when the floor cannot sustain the necessary anchor loads, e.g., when the slab is too shallow or the compressive strength of the concrete is too low. External bracing, mostly in the form of overhead bracing, can take up part of the anchor loads. Several forms of external bracing are in use:
  - **Overhead Bracing**--Bracing electromechanical equipment to ironworks is a common practice. This method requires the ironworks to be strong enough to carry the additional seismic load. Extra diagonal bracing and hanger-rod bracing may be required to reinforce the ironwork. Hanger-rod bracing can be achieved by using Unistrut™ with jam bolts to improve buckling capacity.
  - **Side-Posts**--Floor-to-ceiling side-posts are positioned at each end of a lineup (see Figure 8). The tops of each component of a lineup are tied to the posts to provide overhead bracing. This method is a very practical solution to raised floor installations.
  - **Cable Bracing System**--Developed in the mid-70s, cable bracing was used in several central offices in California (see Figure 9). Steel cables are anchored to structural walls and columns within the equipment area. The cables are located a few centimeters above the equipment. Special hardware is used to tie the equipment tops to the cables. The tops of the lineups are mechanically junctioned.
  - **Mechanical Frame**--An extremely stiff framework installed within a lineup, it provides extra stiffness (see Figure 10). It increases the fundamental natural frequency of the equipment to reduce anchor-load, carry requirement. This frame provides strength in the longitudinal direction, which is usually the weaker direction of the equipment frame/cabinet.
  - **Structural Pedestal (For Raised-Floor Installations)**--Most raised-floor systems are designed to carry only vertical load. Hence, lateral load induced by equipment on the raised floor (due to lateral ground shaking) may be a problem. One method to ensure equipment protection for raised-floor application is to strengthen the lateral load-carrying capacity of the raised floor. Another method is to protect the equipment independently from the raised floor, by using a separate structural support for the equipment. This method is more cost-effective since the structural

## RECOMMENDATIONS FOR LIFELINE SEISMIC STANDARDS

pedestals are required for the equipment, and not for the raised floor.

### **IV-2.2.3 Existing Knowledge**

The knowledge base is quite extensive, and Japan's research and development data can provide additional information in developing standards. Knowledge from other lifeline risk models can be helpful.

### **IV-2.3 Standards Plan For New Facilities/Construction (NF)**

Priority should be given to developing standards for new construction to be deployed in the telecommunication system. However, the same urgency applies to upgrading existing systems. Interdependency of lifelines should also be evaluated and consistency should be maintained across the lifeline standards. For example, if electric power facilities are required to restore power supply within three days after an earthquake, then the backup generators in telecommunication should not be required to carry a fuel supply much longer than that. Hence, the timing of implementation of the lifelines standards is important.

More studies and research are needed to enhance the knowledge base in key areas, such as network risk assessment and modeling. Collating and disseminating available knowledge is a necessary first step.

#### **IV-2.3.1 Scope**

The standards should cover all telecommunication systems: public, private, and wireless. The objective is to develop a set of standards and codes for new construction that will help the industry meet goals. The cost estimate for each task is based on \$100,000.00 (\$100K) per professional person-year. The time estimate is the duration of the task.

#### **IV-2.3.2 Standards Plan**

##### **Task NF1--Building Structures**

*This task is to evaluate the existing codes and practices of designs for facilities, including storage structures. Generate a report with recommendations that can form the basis for a standard.*

Involve qualified earthquake engineers to develop a draft standard for all buildings that house lifeline equipment. The standard should include site-preparation requirements to reduce the effects of building-to-ground displacement.

By the time this task is awarded to a contractor, FEMA's NEHRP Recommended Provisions for the Development of Seismic Regulations for New Buildings will be available in the 1991 edition.

The estimated cost is \$250K for a period of two years. Potential developers are ATC, International Council of Building Officials (ICBO), Building Seismic Safety Council (BSSC), National Center for Earthquake Engineering Research (NCEER), and consultants (both structural and geotechnical).

##### **Task NF2--Raised-Floor Applications**

Develop and evaluate methods, including anchorage, for raised-floor installation. Develop

standard practice for raised-floor applications.

There have been a fair number of studies and research on this topic. Japanese research and development data on this topic can help speed up the development if the information is made available.

The estimated cost is \$250K for a period of two years. The potential developers are experts from the telecommunication industry, Bellcore, research organizations, and consultants.

### **Task NF3--Active Equipment And Battery Racks**

Develop seismic standards for equipment, frames, racks, and bracing. An ANSI committee (T1Y1.4 SWG3) is in place to develop an equipment standard for seismic protection of electronic equipment used in the telecommunication systems. The standard proposal, which is based on NEBS, IEC (International Electrotechnical Commission), and IEEE (Institute of Electrical and Electronic Engineers) specifications is not fully accepted by the committee yet. Recommendation is to have ATC included in the evaluation process. The standard should contain a zoning map or reference to a zoning map, design criteria, tests methods, and analysis methods.

The estimated cost is \$200K for a period of two years.

### **Subtask NF3A--Multiaxis Test Methods**

Conduct research to establish the benefits of standardizing multiaxis test methods.

The estimated cost is \$250K for a period of one year. Potential developers are research organizations, universities, Bellcore, consultants, and manufacturers.

### **Task NF4--Cable-Handling System (Including Bus Bars)**

Develop test methods for determining the load-carrying capacity of the ironworks with different site constraints. Prepare a report that includes recommendations of design approaches and installation practices and details of the components to be used.

Develop a draft standard for design/installation practices from the resulting models.

Some preliminary work on the cable-handling system was done by Bellcore a few years ago. This information, if made available, will simplify some of the work required to establish design guidelines.

The estimated cost is a total of \$250K for a period of three years. Potential developers are Bellcore, research organizations, and universities.

### **Task NF5--HVAC**

Investigate existing design and installation practices in seismic zones and evaluate the existing standards if available. Produce a report based on the investigation that describes the design and installation practices, analyzes vulnerable areas (including dependency on other lifelines, such as power and water), and makes recommendations for improving design and installation for seismic application. Produce guidelines to enhance the performance of the in-place equipment against

## *RECOMMENDATIONS FOR LIFELINE SEISMIC STANDARDS*

seismic damage. In addition, develop a draft of standards for design and installation.

The estimated cost is \$500K for a period of four years. Potential developers are experts from the telecommunication industry, manufacturers, and consultants.

### **Task NF6--Support Facilities (AC Distribution, Fire-Suppression)**

Evaluate existing design guidelines for installation practices for these facilities. Prepare a proposal for a draft standard to enhance existing practices or to establish a unique standard practice for telecommunication facilities.

*This task should include all nonstructural elements, for example, light fixtures, suspended ceilings, and accessories, such as test equipment, as indicated in Section 2.2.1.*

The estimated cost is \$150K for a two-year period. Potential developers are consultants, experts from the telecommunication industry, and manufacturers.

### **Subtask NF6A--Fire-Suppression Capabilities In Lifeline Equipment Offices**

In addition to the work above, a study should be carried out to evaluate the requirements or necessity of fire suppression in lifeline equipment offices.

The estimated cost is \$500K for a two-year period. Potential developers are consultants, experts from the telecommunication industry, regulatory agencies, and fire departments.

### **Task NF7--Spares Storage**

Collate available methods to protect components on shelves and open racks. Develop and document a standard practice.

The estimated cost is \$100K for two years. Potential developers are TCLEE, experts from the telecommunication industry, Bellcore, and consultants.

### **Task NF8--Backup Generator**

Evaluate state-of-the-art design and installation practices. Identify and analyze design deficiencies related to earthquake performance. Produce a draft standard for generator design and installation practices.

The estimated cost is \$350K for a period of four years. Potential developers are manufacturers, consultants, and experts from the telecommunication industry.

## **IV-2.4 Standards Plan For Existing Facilities (EF)**

The development of standards for retrofits and upgrades to bring existing systems to an acceptable level of risk can be pursued in parallel with that for new constructions.

### **IV-2.4.1 Scope**

The standards should be applicable to all telecommunication systems: public, private, and wireless. The objective is to bring all the communications systems to a reasonable level of seismic

protection.

#### **IV-2.4.2 Standards Plan**

##### **Task EF1--Building Structure**

Investigate the seismic force resistance of existing buildings, including storage facilities, and determine the level of protection. Provide standard design practices to improve the level of survivability. The level of survivability should be established based on the degree of importance of the facilities in the system. More stringent requirements are necessary for critical facilities.

FEMA has developed several reports that can assist in the effort, such as *A Handbook For Seismic Evaluation Of Existing Buildings* (FEMA 178) and *Techniques For Seismically Rehabilitating Existing Buildings* (FEMA 172), both of which are in the process of consensus review revision by the BSSC and will soon be reissued as NEHRP Handbooks. Additionally, the BSSC, together with ATC and ASCE, is initiating a project to develop consensus-based guidelines for seismic rehabilitation of buildings. The consensus versions of FEMA 172 and 178 should be reviewed, and participation in the BSSC guidelines development effort should be established.

The estimated cost is \$200K for a period of two years. Potential developers are consultants, ATC, NCEER, and BSSC.

##### **Task EF2--Active Equipment (This task is combined with Subtask SP3A.)**

Investigate and evaluate the in-place equipment to determine their seismic force resistance according to existing specifications. Develop guidelines to bring the equipment to present design levels.

The estimated cost is \$150K for a period of two years. Potential developers are TCLEE, NCEER, Bellcore, and consultants.

##### **Task EF3--Cable-Handling System (This task is combined with Subtask SP3A.)**

Develop methods for retrofitting existing cable-handling system in parallel with Task NF3. Perform tests to verify retrofit methods. Prepare a report on design guidelines based on the test results.

The estimated cost is \$150K for a period of two years. Potential developers are Bellcore, research organizations, and universities.

##### **Task EF4--HVAC**

This task is covered under the development of the standard for new constructions. Guidelines produced in Task NF5 can be applied for upgrades.

##### **Task EF5--Support Facilities**

This task is identical to Task NF6. Guidelines produced in Task NF6 can be applied as retrofit guidelines.

## RECOMMENDATIONS FOR LIFELINE SEISMIC STANDARDS

### Task EF 6--Spares Storage

This task is identical to Task NF7. Standard practices produced in Task NF7 should be the same for retrofit and upgrade purposes.

### Task EF7--Backup Generator (This task is combined with Subtask SP3A.)

Evaluate methods to protect generators and improve their seismic performance.

Various methods for protecting generators exist at present. The effort required here is to evaluate these methods and the cost-effectiveness of upgrading.

The estimated cost is \$150K for a period of one year. Potential developers are consultants, experts from the telecommunication industry, and manufacturers.

## IV-3. OUTSIDE TRANSPORT FACILITIES

### IV-3.1 Introduction

Outside transport facilities include all facilities connecting switching facilities. From a network modeling point of view transport facilities constitute branches of the network. In addition to the obvious links, such as cables, they include repeaters on long lines, which are used to step up the signal level and maintain signal quality. Large private exchanges may not need repeaters in connecting lines to remote offices unless they are more than 15 km away.

Transport facilities are usually exposed to an environment that is more hostile than that for switching facilities. Consequently, they have received more attention in terms of design and installation. However, some of the precautions as practiced today are not adequate, and in some cases, seismic hazards such as ground motion are not considered.

### IV-3.2 State Of The Art

#### IV-3.2.1 Vulnerability

For outside transport facilities, evaluation of vulnerability can be divided into four areas:

- **Site Evaluation**--Site and geology are important factors affecting outside transport facilities since they are widely and spatially distributed. Landslides, liquefaction, faulting, and lateral spreading are some of the hazards affecting the facilities. Collapse of structures, such as buildings, bridges, etc., can destroy outside plant cables instantly. Manholes and CEVs are vulnerable to the same hazards; even though they may be structurally undamaged, the cables entering and exiting the facilities may be severed.
- **Loop/Trunk Distribution**--Site evaluation is an important part of loop/trunk distribution planning, and the method of routing is also important. The design of conduit joints is critical to prevent joint separation and, hence, cable damage. Buried cables without conduits are more susceptible to seismic hazards.

Right-of-way crossing and access is another hazard to be considered when planning a loop/trunk route. A trunk that is secured to a bridge may meet the same fate as the bridge during an



earthquake. Redundant routes may be required to reduce the risk.

With the forthcoming development of the next-generation signaling scheme, Common Channel Signalling (CCS) with Signalling System #7 (SS#7), this network should have alternate access to ensure system integrity. Special considerations for locating these central control facilities are mandatory. A call cannot be completed to a called party when the CCS with SS#7 link to the central office of the called party is severed, or when the facility is destroyed.

Fibre optic cables as trunks provide enormous capacity compared to copper cables, and they promote concentration and consideration of lines. System vulnerability is increased. For instance, a severed fibre optic trunk can reduce 50 times more circuits than a copper trunk. Photo 10 shows a buried fibre optic cable, while Photo 11 shows an above-ground fibre optic cable routing practice. The fibre optic cables, shown in Photo 11, are owned by different carriers; however, they are using the same right of way.

- **Towers (includes guided and nonguided)**--Towers built on top of multistory buildings are subject to high seismic force due to amplification. The theory that wind load dominates seismic load should be carefully reevaluated. Old towers designed to old codes are especially vulnerable, and the impact of damage to these towers should be evaluated.

Currently, there are no standards or codes for tower designs to resist seismic force. Information and data on tower seismic performance are lacking.

- **Repeater stations (includes radio equipment)**--The equipment used in repeater stations may be different from those in the switching facilities. However, the degree of vulnerability is the same, since a repeater station differs from a switching facility only in size and amount of equipment. Both have battery reserves, active equipment, etc.

Emergency services have their own repeater stations with a different type of radio equipment. Some of these are small enough to be placed on a desk or a shelf, with battery backup located at a corner of an open space. Equipment of this type may fall off desks and shelves, thus disabling the emergency services. Precautionary measures to prevent such mishaps can be addressed by a guide or standard practice, rather than a standard or code.

#### IV-3.2.2 Current Practices

For BOCs, the installations for transport facilities follow the Bellcore specifications. They are TR-TSY-000043 (Above-Ground Electronic Equipment Enclosures) and TR-TSY-000026 (Below-Ground Electronic Equipment Enclosures). Much of this information originated from Bell System Practices. However, these specifications do not address seismic-related design and installation practices. Additionally, there is a knowledge gap in certain areas, such as fibre optic cable.

It is common practice to leave cable slack between splice points or between poles. Though not driven by seismic considerations, this practice reduces the possibility of excessive strain on the cable due to ground movement. Historically, trunk groups are run in conduits, but conduits have a high initial cost and the investment can only be recouped in expansions. For new companies starting up their own trunks, conduits are high-cost items, which reduce their competitiveness. Studies of the construction and material used for the conduits, and the structural protection they

## *RECOMMENDATIONS FOR LIFELINE SEISMIC STANDARDS*

provide to cables, are required.

### **IV-3.2.3 Existing Knowledge**

When the site conditions are known, methods of site treatment are available, and these can be used to mitigate damage due to ground strains. The appropriate site preparation practices for particular site conditions can be documented.

For towers, there is a need to collect and study seismic performance data in order to understand their failure mechanism. Design criteria can then be established.

The performance of fibre optic cable inside a conduit subject to ground shaking requires study. Installation techniques in the form of design specifications should be established.

### **IV-3.3 Standards Plan For New Facilities (NF)**

#### **IV-3.3.1 Scope**

The intent is to establish state-of-the-art design methods and criteria to reduce the impact of seismic hazards to outside transport facilities. The standards cover all systems, including public and private systems.

#### **IV-3.3.2 Standards Plan**

##### **Task NF9--Underground Components (CEV, Manhole, And Conduit)**

##### **Subtask NF9A--Review Of State Of The Art Of Underground Components And Development Of Guidelines**

Collect and evaluate the knowledge available through workshops and technology exchanges with Japan. Review studies on buried pipelines (liquid fuel, water and sewage) to improve understanding of the impact of ground strain on conduits. Correlate this information with induced cable strain. Prepare a report on guidelines for the standards unique to telecommunications applications. The guidelines can be used for upgrading existing installations.

Fibre optic cable can be added to the pipeline field test set up at Parkfield, California, to obtain data.

The estimated cost is \$300K for a period of two years. Potential developers are research organizations and universities. The effort should be coordinated by EERI, NCEER, or TCLEE.

##### **Subtask NF9B--Trunk Routing**

In cooperation with telecommunication network owners, evaluate and review trunk routing. Identify critical links and study site conditions of these links. Prepare proposals to upgrade facilities so identified. The proposals should include design guidelines, procedures for upgrade, and material provisions.

Draft a standard containing methods and design criteria for new installations of CEVs, manholes, and conduits specific to telecommunication networks.

The standard should include procedures for site preparation for each of the three components, and construction and material provisions. Design details of junctions between CEVs, manholes, and conduits should be specified. The standard should also specify site conditions.

The estimated cost is \$300K for a period of three years. Potential developers are Bellcore, consultants, and experts from the telecommunication industry.

### **Task NF10--Towers**

#### **Subtask NF10A--Performance Of Towers During Earthquakes**

Evaluate performance of towers during earthquakes and use findings to establish a baseline for the standard. The study should include analysis of damage to towers constructed according to existing practices.

The estimated cost is \$100K for a period of one year. Potential performers are consultants, research organizations, and manufacturers.

#### **Subtask NF10B--Guided And Nonguided Towers**

Prepare a draft standard that includes guided and nonguided towers. Verify the design standards against analysis performed in Subtask NF10A. Establish guidelines for retrofit design.

The standard should include design criteria and provisions for location (e.g., on top of multistory buildings, on hilltops, etc.). Site preparation provisions should meet the standard developed under Task NF9.

A committee formed under the subworking group EIA (Electronic Industry Association) of the TIA (Telecommunication Industry Association) has been developing standards related to tower construction. Its findings and efforts can be used in this task. A revision on the seismic protection portion can be added to RS222.

The estimated cost is \$200K for a period of three years. Potential developers are TIA/EIA TR14.7 RS222 committee, consultants, and tower manufacturers.

### **IV-3.4 Standards Plan For Existing Facilities (EF)**

The task for this part of the plan requires full cooperation from the telecommunication network owners, without which the task may not be carried out.

#### **IV-3.4.1 Scope**

The intent is to cover critical links with high exposure to seismic hazards. The effort is not to eliminate damage but to minimize damage.

#### **IV-3.4.2 Standards Plan**

### **Task EF8--Underground Components (CEV, Manhole, And Conduits)**

The studies and guidelines produced under Task NF9 cover the upgrades to existing facilities.

## RECOMMENDATIONS FOR LIFELINE SEISMIC STANDARDS

No additional work or cost is required.

### **Task EF9--Towers**

Upgrade of existing towers is included in Subtask NF10A.

No additional work or cost is required.

## **IV-4. SYSTEM AND SPECIAL SERVICES**

### **IV-4.1 Introduction**

Recent technology has extended the service of the telecommunication system from POTS to multiple function services, including ISDN, Centrex, data, 911 emergency, video, and other business-specific services. Both private and public sectors depend on the network as an integral part of their operations. Since this expansion is in response to various needs and trends, a lack of consistency in system development makes the system more vulnerable. This danger, aside from those posed by earthquake hazards, has been identified by the Committee on Review of Switching, Synchronization and Network Control in National Security Telecommunications. Furthermore, due to cost considerations, modern flexible equipment must operate in a network with a high percentage of inflexible equipment, or in an environment that cannot use any automated network management features.

Network management is the part of the system that supervises and controls the switching network. The objective is to maintain the call completion capabilities of the network to the engineered capacity.

The network management functions are:

- To detect an adverse traffic condition
- To determine which calls should be denied into the network, and at what level they should be blocked
- To maintain the highest possible percentage of completed calls

Hence, system-level performance standards are essential to restore consistency and to ensure interoperability when needed. They are needed for preventive management of seismic risks. System-level performance standards are important if the industry is to move forward together.

### **IV-4.2 State Of The Art**

#### **IV-4.2.1 Vulnerability**

A common occurrence in the telecommunication systems during an earthquake is focused overload. A system is not designed to handle calls above its capacity, which is set according to the traffic patterns of each central and toll office. It is not cost-effective to provide full-capacity connectivity to all subscribers when the highest demand at peak periods is only a small percentage of a full-capacity connectivity. Overload can be minimized by educating the public; they should be made aware that (1) indiscriminate use of the phone during and after earthquakes may cause

hardship for people who need assistance, (2) the phone should be used only for emergencies, and (3) a receiver should be placed back on its hook when it has been knocked off by an earthquake. This information can be disseminated by the telecommunication industry.

Telecommunication operators can use network management features to direct or manage traffic to avoid overload. However, as the trend is moving toward unmanned offices, activating a special function for overload control may require human intervention. An alert mechanism should be in place to prompt key individuals to monitor and execute special functions (e.g., for essential services) in an emergency. Much of this planning has already been included in the system operator emergency response plan, which is set up to handle adverse situations, including earthquakes.

As a backup mitigation measure, the number of alternate routes can be increased. This will reduce concentration and improve dispersion. Planners of the telecommunication network should have a checklist for seismic protection measures, and be educated on the need for considering these measures.

On top of what the private sector can do to enhance the communication network, public policy can be established to improve circuit availability. Policy such as limiting the duration of conversation is a viable means to improve traffic. The policy of who has the authority of making a decision to put a time limit to phone connections during and after an emergency is important. This is a social, economic, and legal issue to be studied. NCEER has been working on this type of investigation, and their involvement will be valuable.

As signalling and circuit connection path functions are moving away from the switching equipment to Switch Transfer Points (STPs) using Common Channel Signalling (CCS) with Signaling System #7 (SS#7), the redundancy inherent in the existing system is greatly reduced. Hence, the new control network should provide sufficient redundant routes to prevent failure. The STP and its peripheral data equipment should meet at least the existing design criteria. Routing of the control links must be reviewed to reduce exposure to seismic hazards.

Hence, in summary, system performance can be improved by educating users, establishing policy, providing backup equipment, using diverse (redundant) routing, providing spare capacity, increasing number of switching points, improving network management, and imposing interoperability.

#### **IV-4.2.2 Current Practices**

There are no uniform practices across the different companies, although there are some remnants of the historic Bell System Practices (BSP) in most of the COs. Furthermore, private networks have practices that are different from the public networks. Telecommunication systems have evolved so quickly after divestiture that it is difficult to track what has changed.

For emergency response, different companies establish different procedures and philosophies. However, the telephone companies and manufacturers have agreements to share/redirect spare parts and resources in the event of an emergency. Several companies own mobile switching units (a central office on wheels), which can be deployed if a switching facility is knocked out by an earthquake. Organizations such as the National Communications System (NCS) are working on emergency response operations. There is no need to duplicate the effort. However, it is important that FEMA and NIST follow through with the NCS effort.

## *RECOMMENDATIONS FOR LIFELINE SEISMIC STANDARDS*

Interdependence of lifelines is an area that has not been addressed in emergency response plans.

### **IV-4.2.3 Existing Knowledge**

Network models for seismic risk assessment of water pipelines systems have been developed. Although the components in water pipelines systems are quite different from those of a telecommunication system, the methods, approaches, and philosophy can be used to develop a system-risk model for telecommunications.

### **IV-4.3 Standards Plan For System And Special Services (SP)**

#### **IV-4.3.1 Scope**

Network systems grow by expansion and evolution; new equipment and facilities are added to the old. It is seldom that a complete, new system is constructed from scratch. Performance standards related to seismic hazard mitigation are an extremely useful tool for planning of expansion and addition to the existing network. A major void exists in knowledge of system performance, and preliminary studies are required to gain insight into the performance requirement.

Another void is modeling of postearthquake function, which can be helpful to expedite restoration and recovery, a good tool for emergency response planning after a damaging earthquake.

This area is viewed as the highest priority topic in developing standards. The system standards development should be carried out in parallel with the research required to close the knowledge gap.

#### **IV-4.3.2 Standards Plan**

##### **Task SP1--Network Risk Assessment And Simulation Model**

With the assistance of telephone companies, collect all relevant information on the telecommunication network with respect to the physical components and network configuration. Identify and list the vulnerable nodes (switching facilities) and links (transport facilities) of the network. For example, several switching facilities may be collocated in the same multistory building, requiring that several nodes be combined into a supernode. Geological location can be another dimension in the model. Hazards from sharing right-of-way should be considered in the links. Capacities of the branches are variables to be considered.

The estimated cost is \$400K for a period of two years. Potential developers are consultants, research organizations (NCEER), and universities.

##### **Task SP2--Postearthquake Restoration Model**

Develop a postearthquake restoration model to identify priorities of the components to be restored to enhance service.

Similar studies have been performed before. Results from these studies should be analyzed and a model of restoration relevant to existing networks developed. The model can be exercised to aid emergency response planning or speed up decision-making after a damaging earthquake.

The estimated cost is \$400K for a period of two years. Potential developers are consultants,

research organizations, and universities.

### **Task SP3--A System Performance Standard**

Establish a system performance standard.

Many issues should be addressed in developing this standard:

- Acceptable level of service reduction
- Acceptable interval/duration of service outage
- Acceptable level of capacity reduction
- Performance of regular services
- Performance of essential services, e.g., 911, emergency services
- Level of restriction in service
- Level of redundancy
- Line load-control protocol
- Lifeline interdependency

The standards developed for equipment and components of the system described in the plan should be an applicable part of the documentation of system performance standard.

Time period in which to implement the system performance standard can be established to allow the existing facilities to catch up to the criteria established. Cost impact versus level of performance has to be studied to determine the acceptable criteria for the system performance. Cost impact would include an increase in equipment cost, installation cost, maintenance cost, or subscriber basic rate. This is basically a socioeconomic issue to be resolved in this task.

The estimated cost is \$1,500K for a period of three years. Potential developers are consultants (including socioeconomic experts), telephone companies, manufacturers, research organizations (NCEER), and government agencies.

### **Subtask SP3A--Design Guidelines And Practices (Existing Knowledge)**

In order to bring the system-level performance quickly to an acceptable level, existing knowledge of good design practices can be assembled in the form of a design guide and practice within the first year. This will allow a head start for bringing the telecommunication system to a higher level of earthquake protection. This will also provide a platform for achieving the ultimate goal of totally uninterrupted telecommunication services.

The necessary information is scattered within the earthquake engineering societies and organizations. FEMA documents should be reviewed and evaluated for inclusion in the guidelines. Documents from U.S.-Japan workshops organized by NCEER are another resource. This task is aimed at collating all design practices known for earthquake hazard reduction of telecommunication systems in a single volume of design guidelines and practices. This should include all facilities mentioned in this plan.

The estimated cost of this task is \$600K for a period of two years, and includes Tasks EF2; EF3, and EF7. Potential developers are ATC, TCLEE, NCEER, and consultants.

## *RECOMMENDATIONS FOR LIFELINE SEISMIC STANDARDS*

### **IV-5. SUMMARY OF STANDARDS PLAN SCHEDULE AND PRIORITY**

Schedule and priority are formulated based on the relative importance of the activities and the existing information available from earthquake experiences to bring the overall system to a standard level of performance. The schedule is based on completing the whole program in eight years.

The priority is based on having the system level standard established prior to the components standards in order to provide a target for the components.

With the existing knowledge base the first task is Subtask SP3A, since this will provide a good starting point in earthquake hazard reduction.

Standards activities are grouped into five categories and priorities set as listed below:

- System/Network Performance
- Outside Transport Facilities
- Reserve Power Facilities
- Building and Support Systems
- Equipment (Battery Racks and Cable Handling System)

Specifications for earthquake protection exist for equipment, battery racks, and cable-handling systems. Postearthquake performance of equipment and battery racks was good when these specifications were applied. Therefore the need for enhancing these standards is low. Furthermore, ANSI T1Y1.4 standards group is working on a standard for equipment protection against earthquake damage.



TELECOMMUNICATION LIFELINES

SUMMARY  
OVERALL SCHEDULE AND PRIORITY

Priority# 1--SYSTEM/NETWORK PERFORMANCE (Total \$2,900K)

Task#	Description (cost \$K)	1	2	3	4	5	6	7	8
SP3A	Design guidelines (600)			xxxx					
SP3	System performance Std (1,500)			xxxxxxx					
SP2	Post EQ restoration model (400)			xxxx					
SP1	Network risk assessment (400)			xxxx					

Priority# 2--OUTSIDE TRANSPORT (Total \$900K)

Task#	Description (cost \$K)	1	2	3	4	5	6	7	8
NF9	Underground components (600)			xxxxxxxxx					
NF10	Towers (300)			xxxxxxxxx					

Priority# 3--RESERVE POWER (Total \$350K)

Task#	Description (cost \$K)	1	2	3	4	5	6	7	8
NF8	Backup generator (350)			xxxxxxxxx					

Priority# 4--BUILDING and SUPPORTING SYSTEMS (Total \$1,950K)

Task#	Description (cost \$K)	1	2	3	4	5	6	7	8
NF1	Building structure (250)			xxxx					
NF2	Raised floor (250)			xxxx					
NF5	HVAC (500)			xxxxxxxxx					
EF1	Building structure (200)			xxxx					
NF6	Support facilities (150)				xxxx				
NF7	Spares storage (100)				xxxx				
NF6A	Fire suppression study (500)					xxxx			

Priority# 5--EQUIPMENT and CABLE SUPPORT SYSTEM (Total \$700K)

Task#	Description (cost \$K)	1	2	3	4	5	6	7	8
NF3	Active equipment/battery racks (200)			xxxx					
NF3A	Multiaxis test evaluation (250)						xx		
NF4	Cable handling system (250)						xxxxxx		

Grand total estimated cost is \$6,800K

## RECOMMENDATIONS FOR LIFELINE SEISMIC STANDARDS

### IV-6. ACKNOWLEDGMENTS

The author wishes to thank Dr. Douglas J. Nyman of D.J. Nyman & Associates for his encouragement.

The author also gratefully acknowledges the contributions of the following expert reviewers:

- Mr. Ted J. Canon,
- Mr. John Foss,
- Dr. Jeremy Isenberg,
- Dr. S. Chi Liu, and
- Mr. Larry Wong,

who took time from their busy schedules to review the draft plan and to participate in the workshop.

The contributions by Lt. Col. Micheal Cleary of NCS and Dr. Masanobu Shinozuka of NCEER during the workshop session in Denver are much appreciated.

Significant input and editing were provided by Dr. Masanobu Shinozuka of NCEER and Dr. Felix Wong of Weidlinger Associates, Inc. Excellent comments were also received from Mr. James D. Cooper and members of ICSSC (Interagency Committee on Seismic Safety in Construction), subcommittee 2, and Anshel J. Schiff of Stanford University.

### IV-7. BIBLIOGRAPHY

Applied Technology Council, *Tentative Provisions for the Development of Seismic Regulations for Buildings*, ATC-3-06. April 1984 Second Printing.

Bell Communications Research, NEBS, Technical Reference (TR) EOP-000063, issue 3, March 1988.

Decapua, N.J. and Liu, S.C. "Protection of Communications Facilities in Earthquake Areas." International Symposium on Facilities in Earthquake Areas.

EERI (Earthquake Engineering Research Institute) *Earthquake Spectra* Volume 4, number 1 and 2, 1988

EERI, *Earthquake Spectra*, Volume 1, number 3, 1985.

EERI, *Earthquake Spectra Supplement to Volume 6*, 1990.

FEMA 142/August 1987 *Abatement of Seismic Hazards to Lifelines: An Action Plan*.

Foss, J., *Earthquake Requirements for Telecommunications Equipment*, U.S.-Japan Workshop on Seismic Behavior of Buried Pipelines and Telecommunication Systems, Dec 4-6, 1984.

Isenberg, J., *Seismic Performance of Telecommunications Structures and Equipment*, U.S.-Japan Workshop on Seismic Behavior of Buried Pipelines and Telecommunications Systems. Dec. 4-6, 1984.

## TELECOMMUNICATION LIFELINES

- Liu, S.C. et al., Earthquake Induced in Building Motion Criteria, Journal of the Structural Division, January 1977.
- Mizard, S.S., Survey of Ongoing Activities in the Abatement of Seismic Hazard to Communications Systems. FEMA 137/July 1987, Vol 3.
- National Research Council, Growing Vulnerability of Public Switched Networks: Implications for National Security Emergency Preparedness, Published by the National Science Foundation 1989.
- Schiff A. J., Feb 1980, Pictures of Earthquake Damage to Power Systems and Cost Effective Methods to Reduce Seismic Failures of Electric Power Equipment, Purdue University.
- Tang, A., Research and Development in Seismic Mitigation of Telecommunications Systems in Canada. U.S.-Japan Workshop on Seismic Behavior of Buried Pipelines and Telecommunication Systems, Dec 4-6, 1984.
- Tang, A., Assessment of Available Methods of Identifying and Retrofitting Vulnerable in Place Communication Systems, FEMA 137/July 1987, Vol. 3. (Federal Emergency Management Agency).
- Tang, A., Two Decades of Communications Systems Seismic Protection Improvements, Third Conference on Lifeline Earthquake Engineering, TCLEE, August 1991.
- Wong, L., Telecommunications Facilities Earthquake Readiness since San Fernando, Third Conference on Lifeline Earthquake Engineering, TCLEE, August 1991.

RECOMMENDATIONS FOR LIFELINE SEISMIC STANDARDS

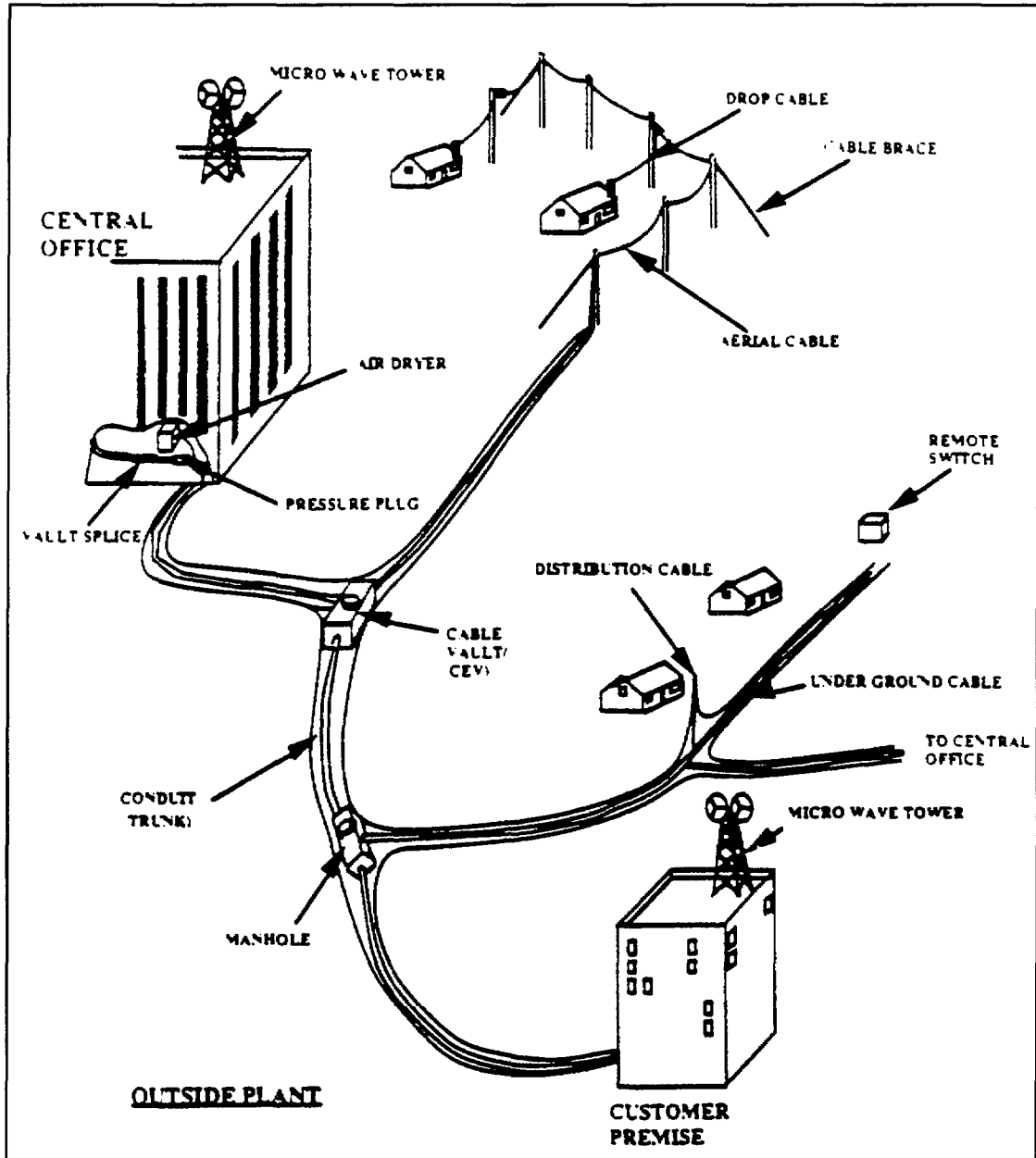


Figure 1. Typical outside plant.

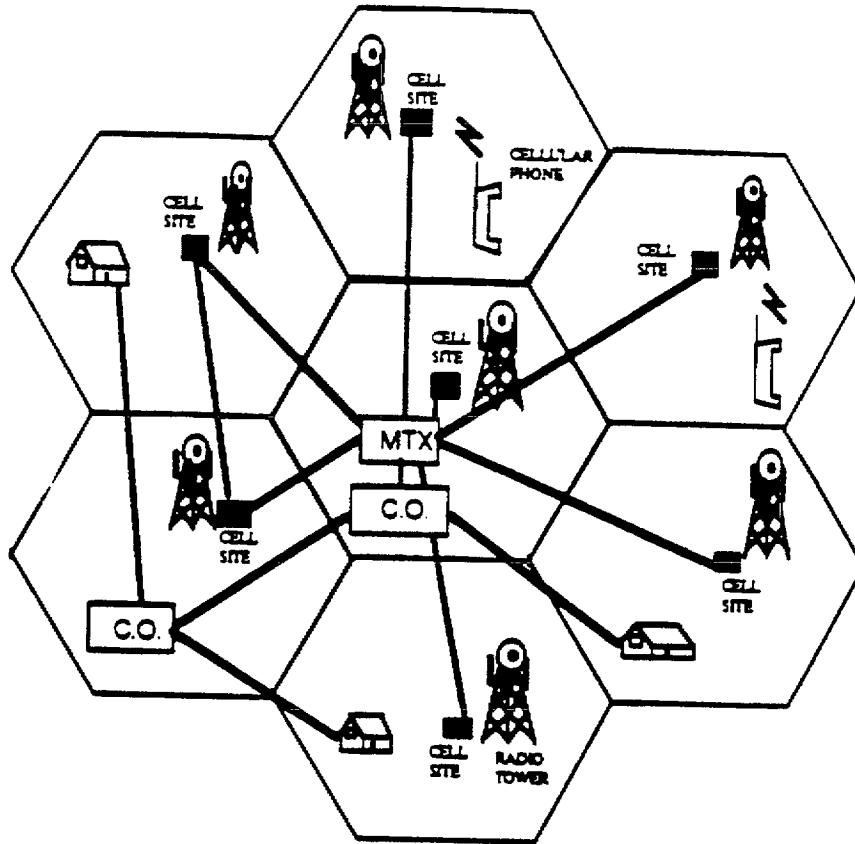


Figure 2. Cellular radio concept.

RECOMMENDATIONS FOR LIFELINE SEISMIC STANDARDS

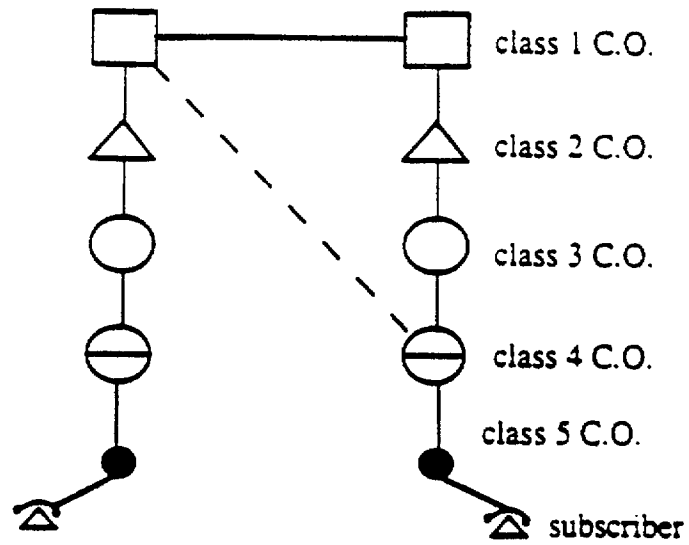


Figure 3. Simplified long distance network.

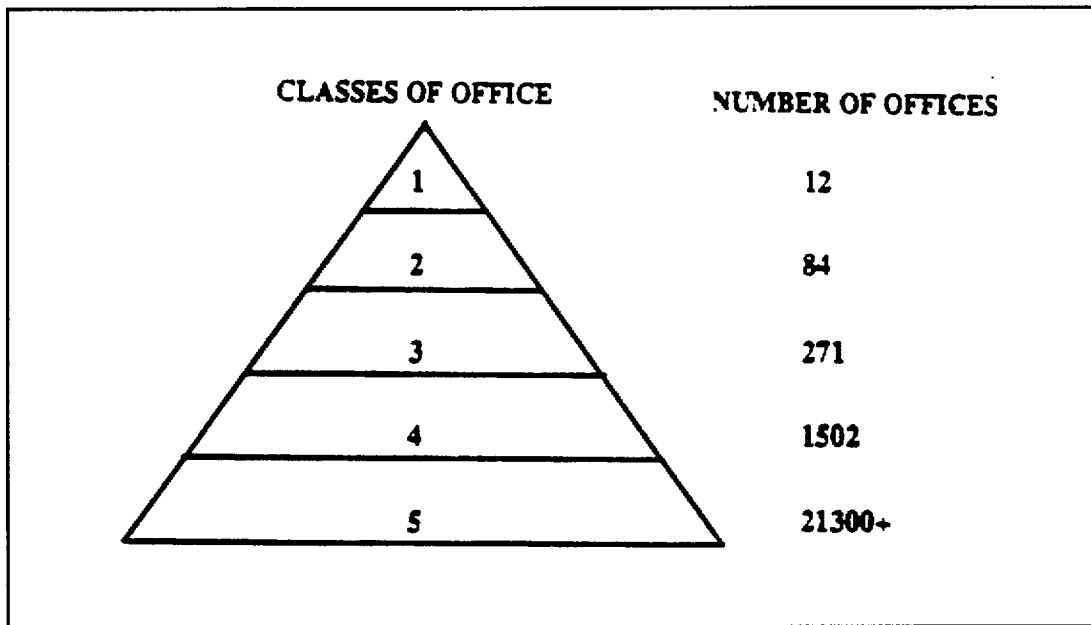


Figure 4. Number of COs in North America (including Canada).

RECOMMENDATIONS FOR LIFELINE SEISMIC STANDARDS

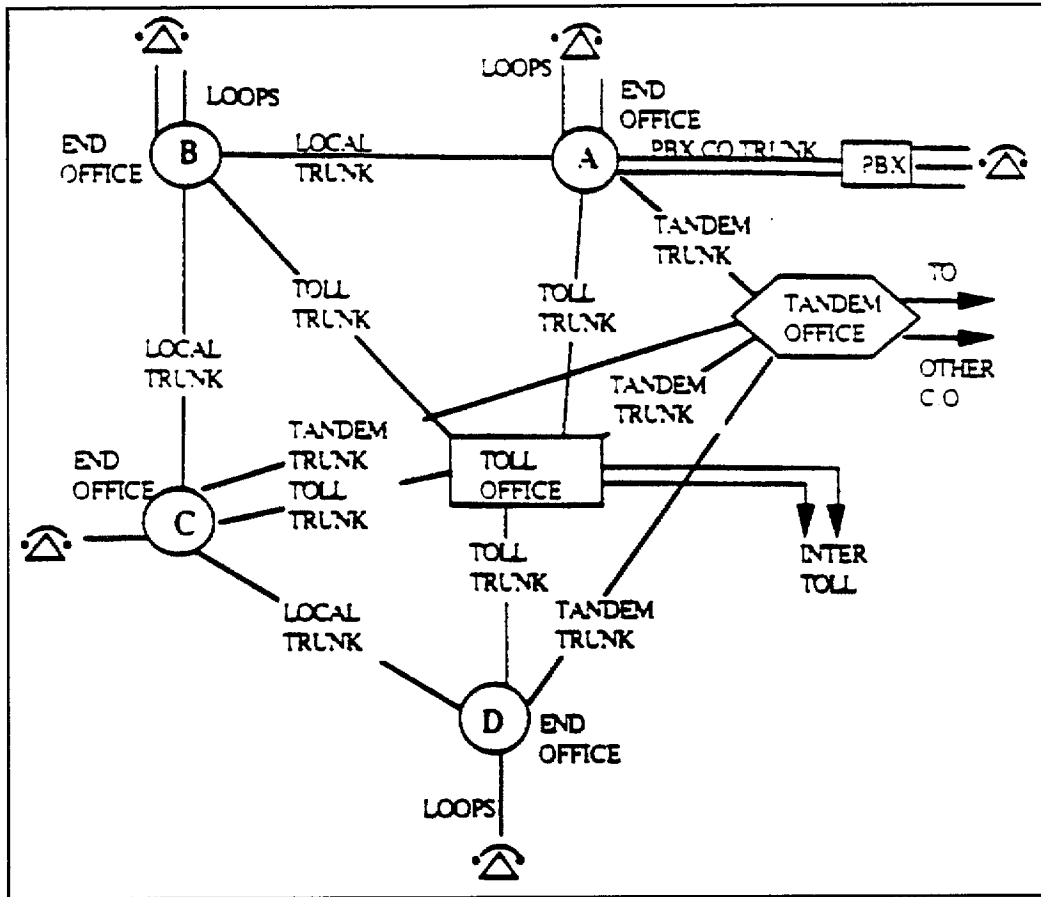


Figure 5. Network interconnection and names of trunks.



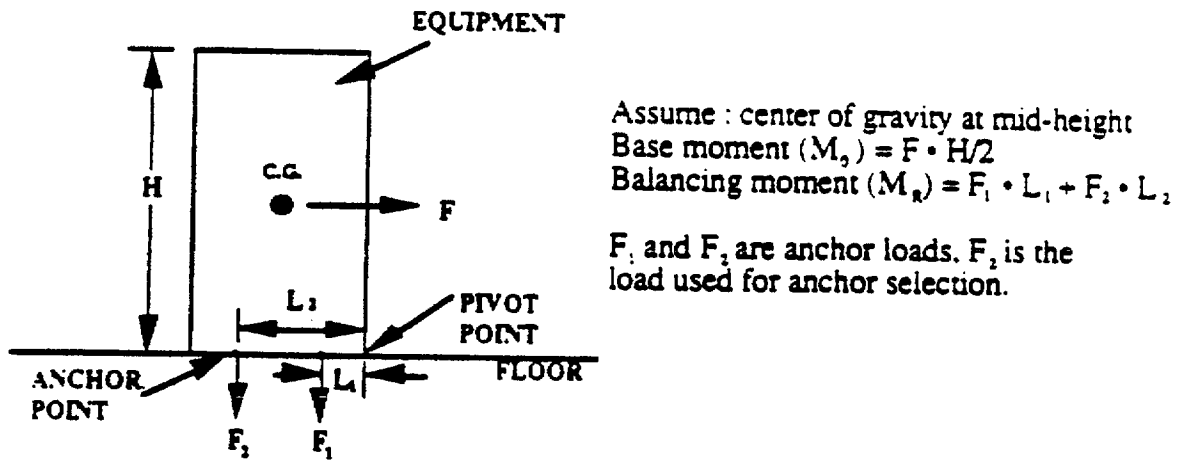


Figure 6. Simplified action vs reaction.

RECOMMENDATIONS FOR LIFELINE SEISMIC STANDARDS

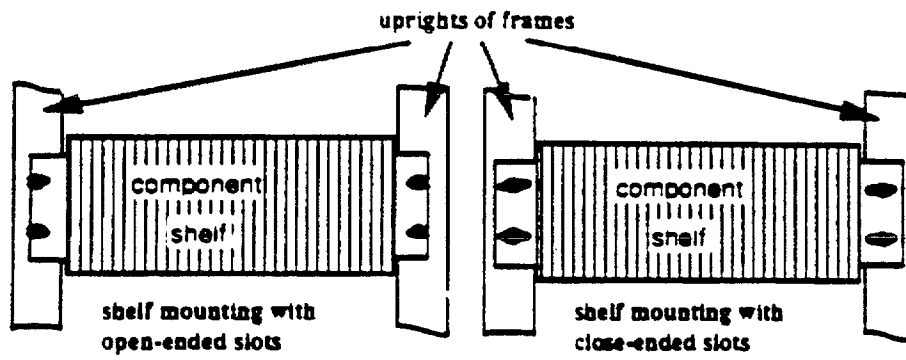


Figure 7. Open slot versus close slot shelf mounting.

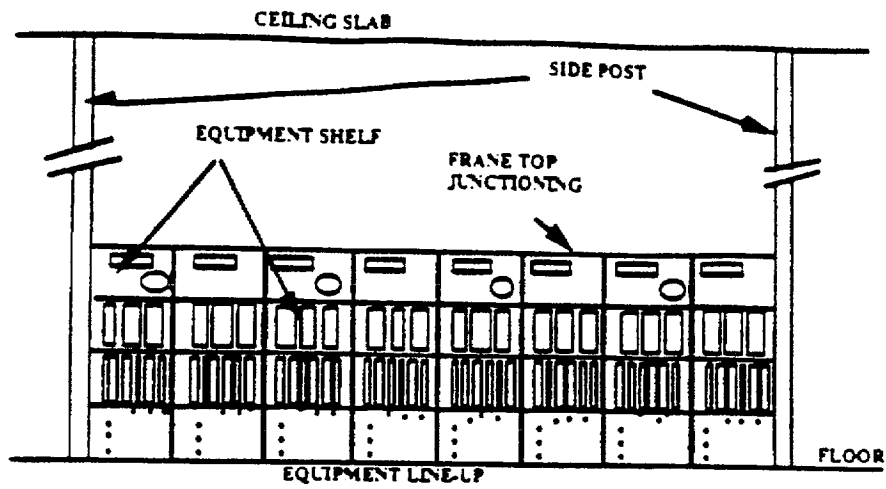


Figure 8. Side post bracing applied to raised-floor application.

RECOMMENDATIONS FOR LIFELINE SEISMIC STANDARDS

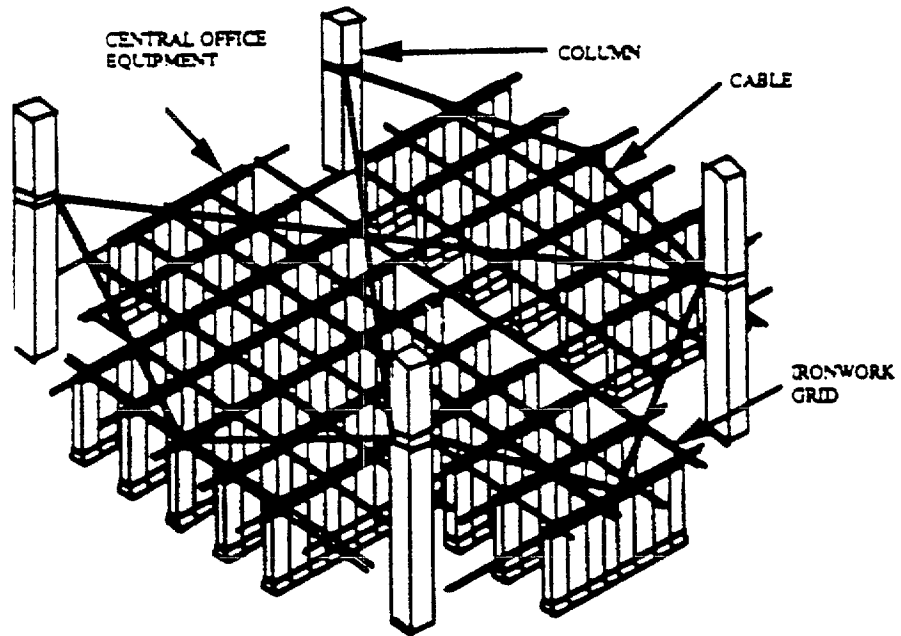


Figure 9. Cable bracing system using columns and walls.

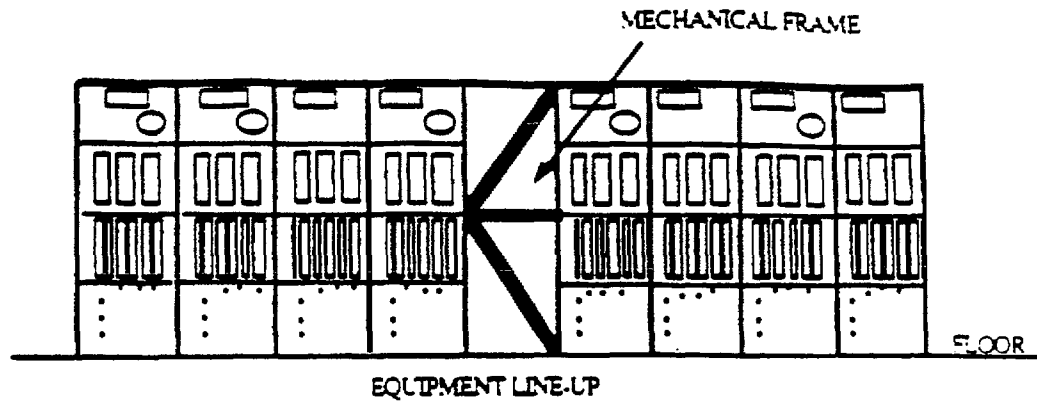


Figure 10. Mechanical frame to stiffen a lineup of equipment.

*RECOMMENDATIONS FOR LIFELINE SEISMIC STANDARDS*

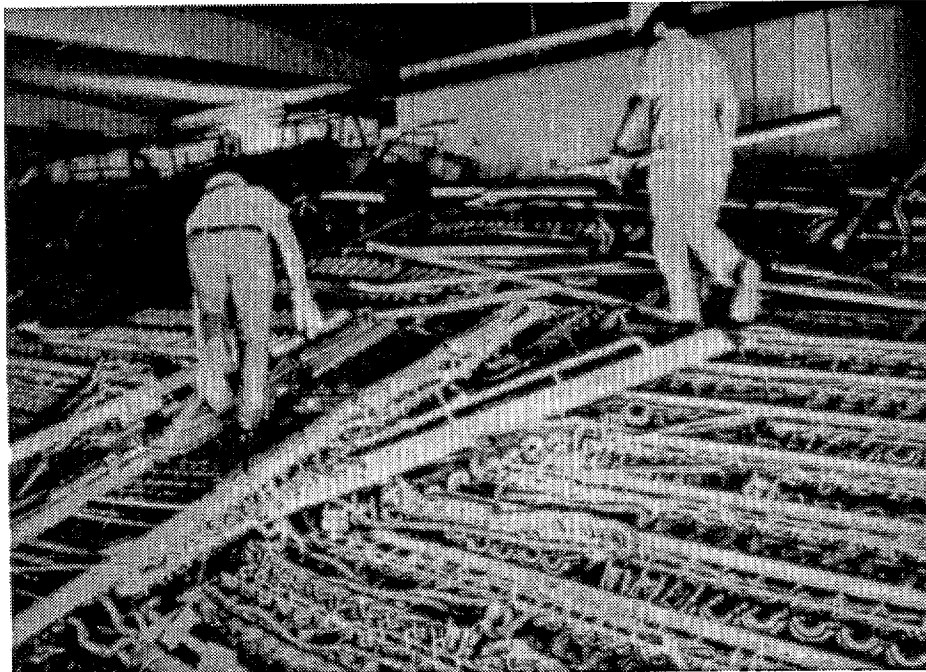


Photo 1. Sylmer CO after San Fernando earthquake 1971. Overhead bracing failure resulted in switching equipment collapse. Cost \$4.5 million to restore.

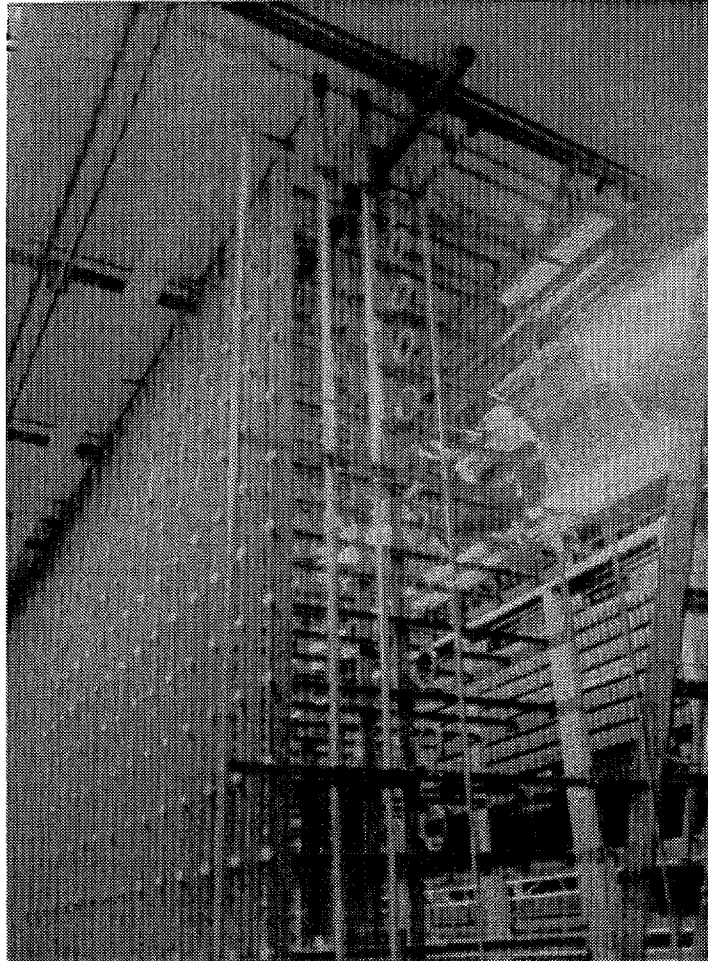


Photo 2. A typical MDF. The far side is the horizontal side. Trunk is connected to the near side. There is no structural strength to this frame. Note the overhead bracing.

RECOMMENDATIONS FOR LIFELINE SEISMIC STANDARDS

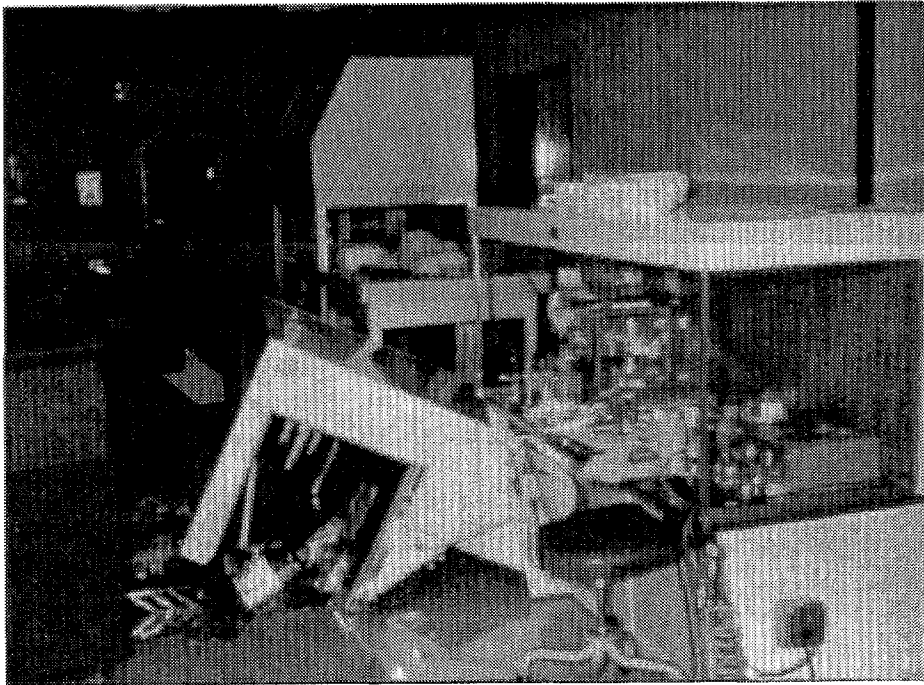


Photo 3. Unanchored equipment does overturn during earthquakes. This picture shows a laboratory work bench toppled during Loma Prieta earthquake 1989.

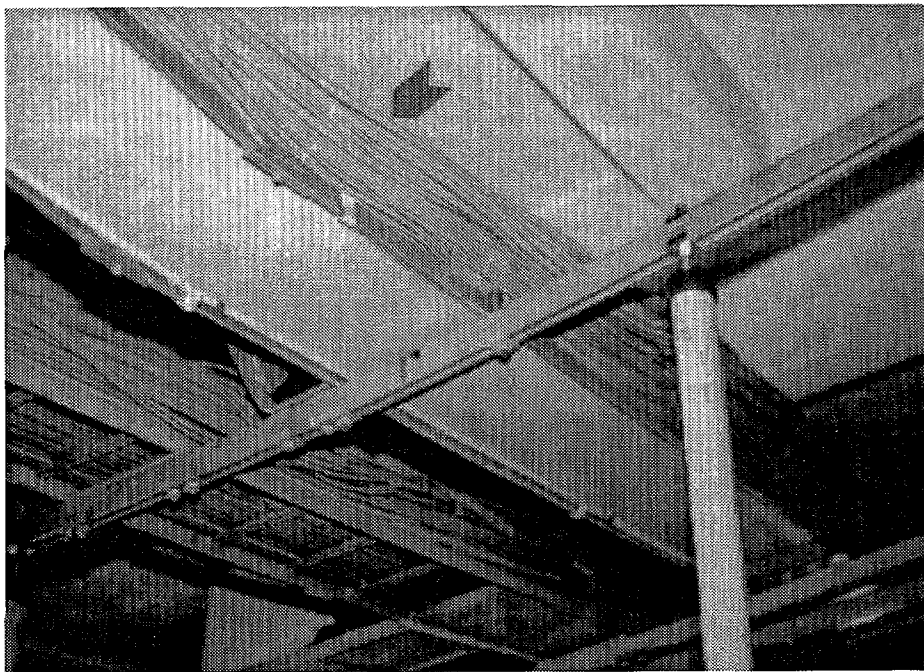


Photo 4. Whittier Narrows earthquake in 1987. An overloaded cable rack collapsed. Note the friction clips used to splice sections of cable racks together. Note the pole supports the ironwork from falling.



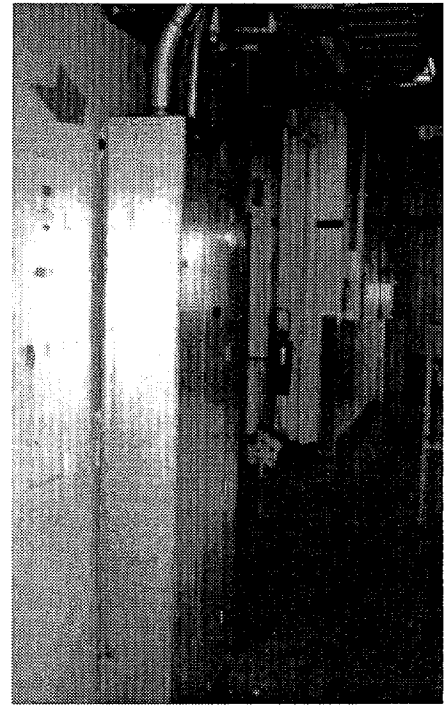
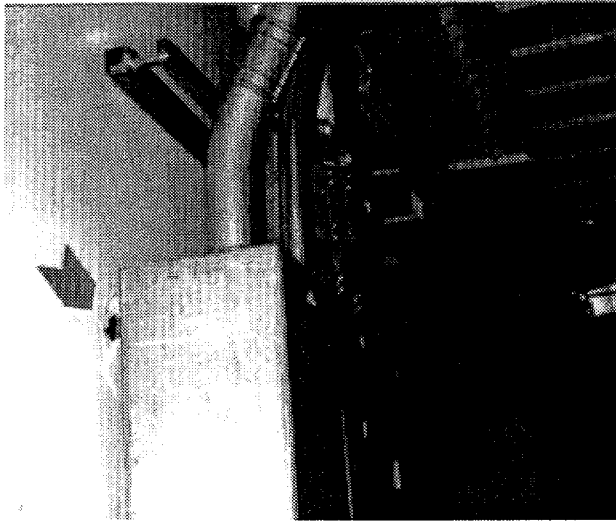


Photo 5. Loma Prieta earthquake 1989. An AC panel in a central office pulled away from the wall. Close up view on the left.



Photo 6. Ironwork failure during Whittier Narrows earthquake in 1987. Note the friction clips used.

*RECOMMENDATIONS FOR LIFELINE SEISMIC STANDARDS*

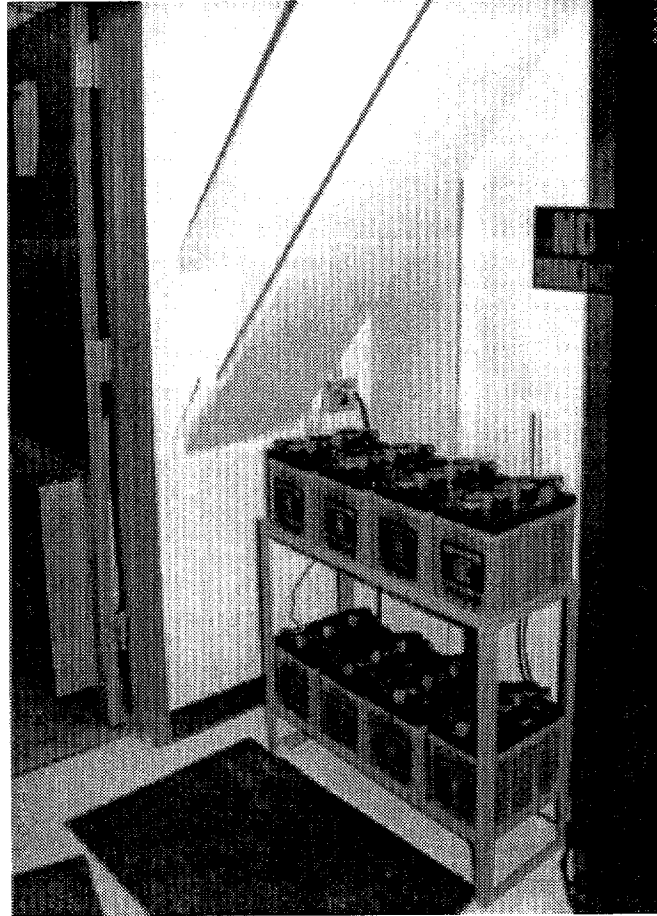


Photo 7. Poor battery mounting, no restraint.

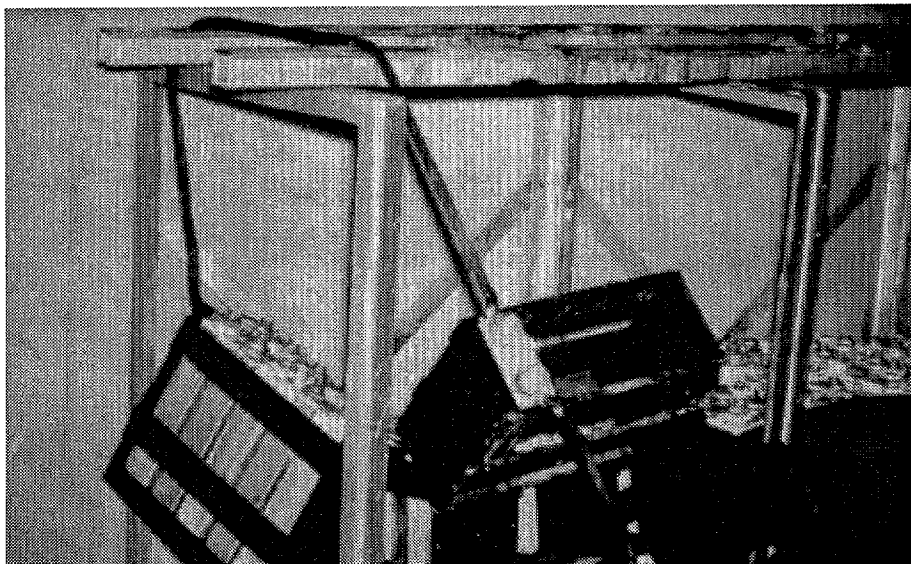


Photo 8. Damaged batteries resulted from not restraining batteries to the rack. Note the rack is not damaged.

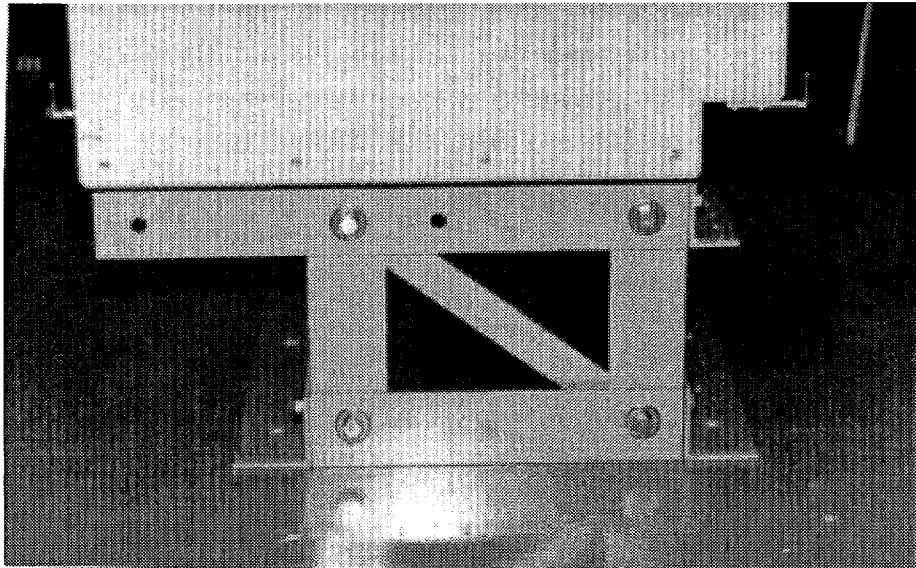


Photo 9. Structural pedestal for raised-floor application. Similar pedestals used in the Bay Area performed well during Loma Prieta earthquake in 1989.

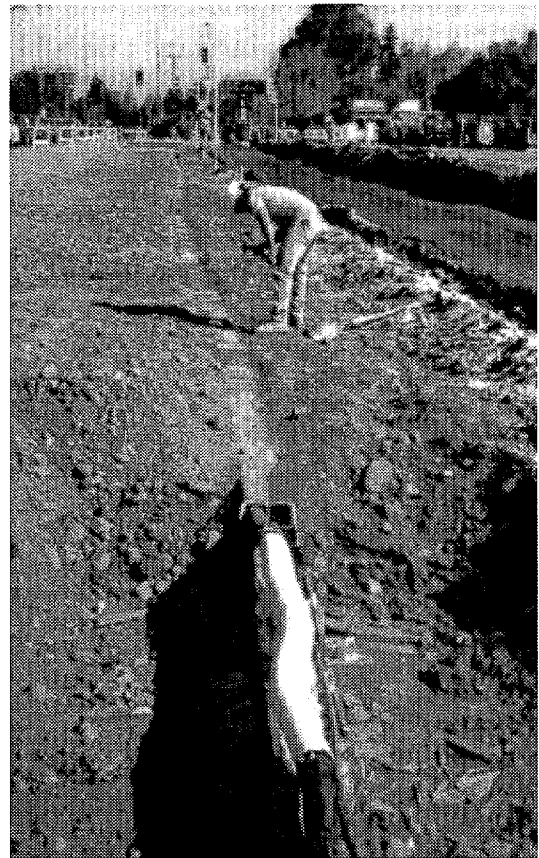


Photo 10. Burying fibre optic cable in process.

*RECOMMENDATIONS FOR LIFELINE SEISMIC STANDARDS*

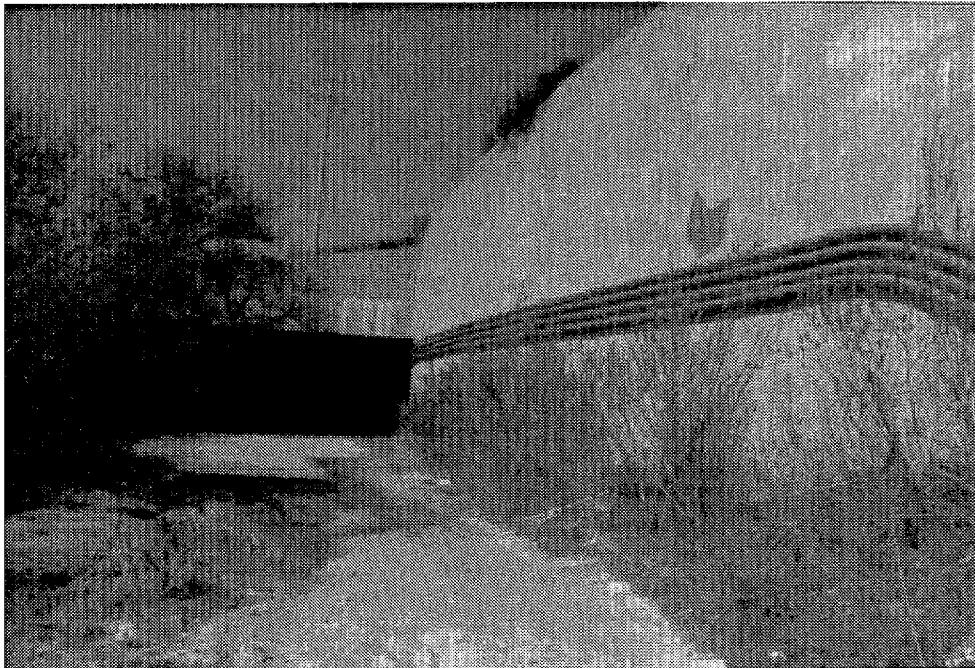


Photo 11. Above ground fibre optic cable routing. Each is owned by a different carrier.

---

## CHAPTER V: TRANSPORTATION LIFELINES

*IAN G. BUCKLE*

---

### V-1. INTRODUCTION

This chapter presents a plan for the development of nationally applicable seismic standards for the design and construction of both new and existing transportation lifelines. Four transportation lifelines are considered: highways, railways and mass-transit systems, ports and waterways, and air transportation facilities. Accordingly, eight standards are proposed, one for the design of new construction and one for the retrofit of existing facilities in each of the above four lifelines.

Each lifeline standard is in fact presented in four parts and comprises a philosophy statement, a performance-based system standard, a collection of prescriptive component standards, and a collection of equipment and material provisions. Emphasis is placed on the importance of developing a consistent approach to all of the transportation lifelines. Several tasks are therefore common between these lifelines. Also, for the design of new construction many of the component standards (bridges, tunnels, pavements, slopes, retaining structures and general purpose buildings), should be generic standards which will preserve consistency and avoid duplication of effort. Unfortunately, this same approach does not seem feasible for the retrofit of existing components.

The plan also provides for the field evaluation of the eight standards. Three sites will be chosen, one each from a high, a moderate, and a low seismic zone, and each standard will be tested for ambiguity, completeness, and cost impact. After this evaluation is complete, a final review is proposed, followed by the development of instructional materials for the education and training of engineers and responsible officials.

To permit the timely development of these standards a research program is also proposed. Both basic and applied research is necessary in order to satisfy the anticipated demands for answers to critical questions, without which rational, defensible standards cannot be prepared.

This development plan extends over eight years and comprises three distinct phases. The first phase includes criteria development and the research program noted above. It will last four years and will overlap the second phase in which the standards themselves are developed. This second phase is three years long. Evaluation, review, and education together make up the third phase, which is expected to take another three years to complete.

The total budget for the development of all eight standards and the support of the accompanying research program is \$31,310,000, over the eight-year period. This figure includes \$12,720,000 for the development of standards for new construction and \$18,590,000 for standards for existing facilities.

#### V-1.1 Transportation Systems

Modern society is totally dependent on a complex network of infrastructure systems, which are frequently hidden from view and almost always taken for granted. These systems are lifelines in today's industrialized society and include the supply of energy and fresh water, the provision of transportation and communication services, and the disposal of wastewater and waste products.

## RECOMMENDATIONS FOR LIFELINE SEISMIC STANDARDS

Infrastructure systems together comprise the fabric by which society and its built environment is threaded together. They are the basic installations and facilities on which the continuance and growth of a community depend, and without which the high standard of living enjoyed today would vanish.

Among the oldest of these lifelines are the transportation systems, which include highways, railroads, mass transit systems, ports, waterways, and airports. Some of these also depend on other lifelines, such as electric power, communication systems, and water and sewer facilities, for their successful operation. Furthermore, other lifelines depend on transportation systems, principally to provide access to key facilities and also to share right-of-way for routing purposes.

Transportation lifelines, like many other lifeline systems, are a collection of diverse structural, mechanical, and electrical components. Individually, they may have little value; collectively, they play a vital role in modern society. For example, a highway system may be comprised of pavements, bridges, tunnels, slopes, embankments, control systems, toll structures and informational signs. Individually, these items have doubtful value, but as a system they have essential and mutually dependent roles to play.

The vast array of lifelines in the United States, their diversity and multiple ownership, makes the accurate compilation of an inventory a nearly impossible task. It follows that the nation's investment in this infrastructure cannot be stated with certainty. Nevertheless estimates have been made for those transportation lifelines in the Public Works sector. Tables 1 and 2 present this data. It will be seen that there are over 6 million kilometers of roads and highways, 570,000 bridges, 41,200 kilometers of waterways, and 23,300 airports (Table 1). The annual investment in these facilities totaled \$60.0 billion in 1984 (Table 2), which was 1-1/2 percent of the GNP for 1983.

Transportation systems, like buildings, are susceptible to earthquake damage. By their nature, however, they respond differently than buildings and for many reasons deserve special treatment. Some of these issues are as follows:

- Transportation lifelines may be sensitive to both permanent ground displacements and horizontal and vertical ground shaking.
- Transportation lifelines almost always have elements that are configured as linear elements ranging in length from tens of meters to many hundreds of kilometers and may therefore also be sensitive to spatial variations in ground motion.
- Some transportation lifelines are located on variable and poor soil conditions dictated by factors outside the control of the designer. They may therefore also be sensitive to site amplification and liquefaction effects, which may vary considerably over the length of the lifeline.

The consequences of failure in a transportation lifeline due to an earthquake or other natural disaster can involve [2]:

- Direct loss of life due to collapse or structural failure of the lifeline
- Indirect loss of life due to an inability to respond to secondary catastrophes, such as fires, and/or provide emergency medical aid

## TRANSPORTATION LIFELINES

- Release of hazardous products (e.g., derailed tank cars due to track failure, gas leaks from ruptured utility lines)
- Direct loss of property and utility service (e.g., damaged utilities carried by a collapsed bridge)
- Losses due to interruption of access (e.g., export losses due to port damage)
- Disruption of economic activity across the nation as well as in the impacted community

Transportation lifelines are owned by both public and private sector agencies and corporations. Federal, State, and local governments have different, but frequently overlapping, roles in lifeline operation and regulation. For example, many Federal, State, and local government agencies own, operate, and/or fund construction of dams, roads, bridges, waterways, and airport facilities. Within the Department of Transportation, seven separate administrations (including the Coast Guard, Maritime Administration, and St. Lawrence Seaway Development Corporation) have collective responsibility for the construction operation or regulation of highways, railways, aviation, urban mass transit, and waterway systems.

### V-1.2 Scope

The purpose of this chapter is to develop a plan for the preparation of seismic design and construction standards for transportation systems.

A standard is defined by the American Society for Testing and Materials (ASTM) as "a rule for an orderly approach to a specific activity, formulated and applied for the benefit and with the cooperation of all concerned." In terms of construction practice this is interpreted to mean a specific set of requirements or instructions for the testing, design, manufacture, installation and use of a building material, component or system [5].

Given the diverse nature of lifeline systems and components and their characteristic dependence on each other, it is important to differentiate between performance standards and prescriptive standards. A prescriptive standard is specific in nature giving details of usage or design procedures for a building material, component or system. An example of a prescriptive requirement would be that wall framing shall be 2 x 4 wood studs on 0.41 m centers. A performance standard prescribes objectives, conditions, and criteria to be accomplished and allows broad leeway for the designer to achieve results. The performance statement for the above condition would indicate the wall system shall be designed to specified loading and deformation criteria, allowing an innovative designer freedom to select the materials and other specific construction details [5].

In this plan the development of both performance and prescriptive standards is required. In general, standards that relate to system performance are performance-based, whereas standards related to individual components are prescriptive in nature.

Five separate transportation systems are addressed in this plan. These systems and their principal components are listed in Table 3.

It is clear from Table 3, that although each system is uniquely different, similar components comprise the different systems. In other words many components are common to more than one

## RECOMMENDATIONS FOR LIFELINE SEISMIC STANDARDS

lifeline, and therefore, some repetition in the prescriptive requirements for these components will be unavoidable. However, performance standards for each system must be tailored to the needs of each individual lifeline.

### V-1.3 Concept

The basic premise underlying this plan is that, for each transportation lifeline, a four-part standard should be drafted, and that each part should address one of the following four issues:

- Philosophy of seismic design and construction
- System design and construction
- Component design and construction
- Equipment and material provisions

#### V-1.3.1 Philosophy

Each transportation standard (or set of standards) must contain a statement that describes the basic philosophy assumed when drafting the system and component provisions. Such a philosophy may, for example, be built on the principle of acceptable damage during a large earthquake. This may be stated for bridges as follows [6].

- Small to moderate earthquakes should be resisted within the elastic range of the structural components without significant damage.
- Realistic seismic ground motion intensities and forces are used in the design procedures.
- Exposure to shaking from large earthquakes should not cause collapse of all or part of the bridge. Where possible, damage that does occur should be readily detectable and accessible for inspection and repair.

For other transportation systems, this philosophy might be expressed in terms of acceptable loss of function for a given period of time.

Further, these standards should be applicable to all parts of the United States, and variations in seismic risk should be accounted for in a rational manner. Uniform seismic-risk maps are available and are recommended for use in such circumstances.

#### V-1.3.2 System Design And Construction

Since it is imperative that each transportation facility operate as a system, it is important that performance standards for each system be established.

Such a standard will restate the philosophy adopted in the previous section but may go further and specify maximum tolerable restoration times for particular facilities for given earthquake events (small, moderate, large). Under these circumstances, criticality of the facility to emergency response and short- and long-term recovery will determine restoration times. The required level of system performance may be so specified, leaving it to the designer to achieve the required standard. On the other hand, the provisions could also spell out various sublevels of performance, highlighting critical elements within the overall systems that need particular attention. To do this, vulnerable and/or nonredundant links must be identified in the standard,



and in view of the present state of the art, this is the preferred course of action.

This same standard should also address the interdependence of these lifelines both within the transportation field and with other nontransportation systems. The issues concerned with collocation of lifelines should also be identified in this standard.

### **V-1.3.3 Component Design And Construction**

As noted in Section 1.2 (and Table 3) transportation systems are composed of a number of discrete structural components. Prescriptive standards for these components that are consistent with the overall system performance requirements need to be developed.

The following components are identified.

- Bridges
- Pavements
- Slopes and embankments
- Retaining walls
- Tunnels
- Buildings
- Special structures (rock shelters, platforms, signs, locks, control towers...)

Mechanical and electrical components and subsystems are also integral parts of these lifelines. Standards for such items are discussed in the following section.

### **V-1.3.4 Equipment And Material Provisions**

Electrical and mechanical equipment, which are found to a greater or lesser extent in all transportation facilities, must also be covered by prescriptive standards. Reference to existing provisions may be possible but should not be taken for granted. Adequate seismic provisions for restraint of equipment and/or continued safe operation are not universally adopted.

Material specifications are available from current codes and standards and should be immediately accessible by cross-reference with little or no difficulty.

## **V-2. PLAN FOR TRANSPORTATION STANDARDS**

### **V-2.1 State Of The Art**

#### **V-2.1.1 Introduction**

As noted in Table 1, there are more than 6 million kilometers of roads and highways in the United States and approximately 575,000 bridges, ranging from 6 m in length to 40 kilometers. The bridge inventory varies from single, simple-span structures to multispan suspension bridges. About one-half are state-owned, and of these, 47,000 are on the interstate system. Approximately 72 percent of these bridges were constructed prior to 1935 with little or no consideration given to seismic resistance.

In addition to bridges, highway systems also comprise pavements, tunnels, slopes, embankments, retaining walls, and some special structures, such as informational signs and rock/avalanche shelters.

## RECOMMENDATIONS FOR LIFELINE SEISMIC STANDARDS

Railroads share many of the same features as highway systems in that they also comprise vast networks of interconnecting links of similar structural components. Amtrak passenger service carries 20 million passengers a year over 40,000 kilometers of track to 530 locations using 350 locomotives and 2,000 railcars. Freight totaling 985 billion metric ton-kilometers in 1975, was hauled over 320,000 kilometers of track using 27,700 locomotives and 1,700,000 railcars. On the other hand, mass transit systems are used almost exclusively for passenger traffic (commuters) in subway systems throughout major metropolitan areas. Some are relatively old (New York City, Chicago), whereas new systems have recently been completed in San Francisco and Washington, DC, and several are currently under construction (e.g., Los Angeles).

There are more than 41,000 kilometers of inland waterways in the United States, which include 170 dams and 225 locks. In addition, there are approximately 2,200 ports operating as marine terminals. Total traffic includes 4,400 tow boats; 28,700 barges; and 575 oceangoing vessels. Ports and waterways not only comprise bridges, wharves, and paved areas (like highways) but also have railroads and many special structures, such as retaining walls (bulkheads and sea bunds) and container cranes, which are essential to their continuing operation.

Airports and air traffic control centers are comparatively new additions to the transportation infrastructure in the United States. Today there are approximately 14,500 airports through which more than 200,000 commercial and private aircraft operate. In addition to airport facilities, there are 23 Air Route Traffic Control Centers (ARTCC) in the United States and corresponding navigational guidance systems for the control and guidance of aircraft traffic between airports. San Francisco International Airport has daily traffic in excess of 1,300 flights with an annual passenger flow of approximately 31 million people. In addition, 570,000 metric tons of freight are handled annually. Land facilities are extensive, and more than 31,000 people are employed onsite. Airports generally have few nonbuilding structures, but the most important are the control towers and their contents. Pavements, bridges, buildings, fuel-storage facilities, and freight- and passenger-handling equipment comprise the remainder of the physical inventory at these sites. The ARTCCs are usually located away from airports, in buildings that contain electronic equipment for radar control and communication with aircraft.

### V-2.1.2 Vulnerability

- **Highways**--The most vulnerable element in the highway system appears to be the bridge component. Historically, bridges have proven to be vulnerable to earthquakes, sustaining damage to substructures and foundations and in some cases being totally destroyed as substructures fail or superstructures are unseated from their supporting elements (Figures 1 and 2). In 1964 nearly every bridge along the partially completed Cooper River Highway in Alaska was seriously damaged or destroyed. Seven years later, the San Fernando earthquake damaged more than 60 bridges on the Golden State Freeway in California. This 1971 earthquake is estimated to have cost the State approximately \$100 million to repair and replace these bridges, including the indirect costs due to bridge closures. In 1989, the Loma Prieta earthquake in Northern California damaged more than 80 bridges in a five-county region, and caused the deaths of more than 40 people in bridge-related collapses alone. The cost of the earthquake to the transportation system was \$1.8 billion of which the damage to State-owned viaducts was about \$200 million and to other State-owned bridges about \$100 million [7].

Pavements are also vulnerable to earthquake damage due principally to ground

failure, such as liquefaction. Recent examples include the failure of the approaches to the San Francisco-Oakland Bay Bridge in October 1989, and the closure of the highway between Limon and San Jose in Costa Rica due to the Valle de la Estrella earthquake of April 1991. Pavements can also be damaged due to fault-rupturing as observed during the Hebgen Lake earthquake in Montana in 1959.

Landslides are another common reason for highway closure, especially in mountainous regions (e.g., Montana (1959), Highway 17 during the Loma Prieta earthquake (October 1989), and the Philippines (Bagiuo, 1990)).

- **Railroads And Mass-Transit Systems**--Although railroad systems suffer damage similar to that caused to highways, their operation is much more sensitive to permanent ground deformation than is a highway's. A survey of damage to railroad components during past earthquakes in the United States and Japan [10] shows damage to bridges, embankment failures, vertical and horizontal track misalignments (Figure 1), tunnel misalignments, failure of tunnel linings, structural damage to railroad buildings, and overturned railcars and locomotives.

Mass transit systems have generally behaved well during large earthquakes (Mexico City, 1985, and San Francisco, 1989). This is most probably because they are essentially buried structures, and few lines actually cross active faults. However, loss of electrical power can disrupt service, as was experienced in San Francisco during the Loma Prieta earthquake of 1989.

- **Ports And Waterways**--Ports and waterways are, by their nature, constructed on soft saturated sites that are susceptible to site amplification effects and/or soil failure (Figure 4). Historically, damage due to earthquakes has included flooding due to tsunamis (Anchorage, 1964), massive flows and flooding due to liquefaction (Seward, Prince William Sound, 1964), and structural damage to wharves and container cranes (Oakland, 1989). Even relatively minor damage can close a port for an extended period of time, and loss of export revenue can have a crippling effect on some economies (e.g., Chile, 1985).
- **Air Transportation Facilities**--Failures of airport runway pavements have occurred in the past due to ground deformation and/or liquefaction effects. In 1989, 900 m of the north end of the 3,000 m runway at Oakland Airport were damaged due to liquefaction, causing the closure of this section of the runway. However, flight operations were not severely impacted in this case, due to an adequate length of remaining undamaged runway. At San Francisco Airport, however, damage to the windows and contents of the control tower caused temporary closure of the facility, followed by restricted operations for a period of 36 hours. The airport terminal building also experienced widespread secondary damage to nonstructural components [12]. The potential for severe structural damage to airports appears to be less than for other transportation systems principally because the basic components are pavements and buildings. However, even minor structural damage can cause closure of a facility and severely impede recovery efforts. Current building codes are life-safety oriented and do not protect against damage to secondary or nonstructural components. Control centers at airports or at en-route centers (ARTCCs) are particularly vulnerable to damage of contents and consequential loss of operation. Similarly, loss of electric power,

## RECOMMENDATIONS FOR LIFELINE SEISMIC STANDARDS

telecommunication, or radar equipment due to relatively minor structural damage can have a major impact on both local and regional air traffic operations (Figure 3).

### V-2.1.3 Current Practice

There are very few standards that have been explicitly written for the design and construction of transportation lifelines. Those that do exist are only for components (e.g., bridges), and none are available that address system-wide performance.

Current practice is therefore based on sound professional judgment, which means that where relevant codes or standards are available, they are used and where absent, design guidelines are based on judgment. This judgment may, in turn, be based on previous experience in the same field or borrowed from similar experience in related fields (e.g., building design).

Of all the transportation components, the highway bridge has been the most closely studied for seismic vulnerability, and standards have been prepared for bridge seismic design.

The best example of such a standard is the seismic specification for *new* highway bridges, adopted by the American Association for State Highway and Transportation Officials (AASHTO) in 1990. These requirements are philosophically defensible and nationally applicable [6]. Some States, such as California, have developed their own seismic specifications for bridges, which take into account regional differences in seismicity and design practice. These alternate requirements must meet or exceed the AASHTO specification as determined by the Federal Highway Administration (FHWA) in order for the State to receive Federal aid for highway construction projects. In the case of California, the State's provisions are judged to be more stringent than the AASHTO specification.

On the other hand, standards for upgrading *existing* highway bridges are not as well developed. A set of retrofit guidelines was issued by FHWA in 1983 [8], and the California Department of Transportation (CalTrans) has prepared in-house material for its bridge engineers, but there is no standard or universal guide for the seismic retrofit of existing bridges at this time.

The same situation is also true for other common modes of transportation, such as railroads and rapid-transit systems. Nationally accepted seismic design requirements do not exist for these systems, and hence considerable differences exist in seismic design requirements and practice. However general recommendations for bridges are included in Chapters 8 and 15, for concrete and steel railroad structures, respectively, of the current American Railway Engineering Association (AREA) Manual for Railway Engineering, but these are not considered to be as rigorous as the AASHTO highway bridge requirements.

In the absence of a unified code, current design practice for mass-transit systems in seismic areas appears to use a selection of codes and standards drawn from various sources. For example, Roberts and Kershaw [11] describe the seismic design criteria used for the light-rail-transit system for Sacramento. The seismic design of the major facilities (bridges, a maintenance building, passenger platforms and shelters, and the overhead electrical catenary support system) was based on the 1982 Uniform Building Code and criteria developed for similar highway and railroad bridges. Similar approaches have been adopted for the Los Angeles Metro Rail System as well as for the Boston subway.

The situation for the other transportation lifelines appears to be similar. There are no codes or

standards written specifically for these systems. Even performance-oriented standards are lacking, and in such a situation reliance is placed on voluntary strategies (e.g., the self-imposition of performance criteria, drawn from various sources and modified to suit the case in hand by the designer in consultation with the owner).

#### V-2.1.4 Existing Knowledge

Whereas significant progress has been made in earthquake engineering research in recent years, most of this progress has been in the area of building response. By comparison, lifeline earthquake engineering is still in its infancy, and there remain considerable gaps in the engineering community's knowledge with regard to lifeline seismic design and response. Transfer of knowledge from the building field is not straightforward because building codes are oriented towards life-safety issues, whereas lifeline standards must also be concerned with serviceability. Furthermore, geotechnical issues play a much greater role in the response of lifelines than for building structures, and soil-structure interaction problems remain largely unresolved.

One exception to this general observation (that existing knowledge is scarce in the lifelines area) is in the highway bridge field. Since the 1971 San Fernando earthquake in California, considerable effort has been directed toward improving the seismic performance of bridges. Research programs were initiated, new standards developed, and instructional material prepared to assist the dissemination of this knowledge. This 20-year effort has culminated in three training courses, which are currently being offered as follows:

- "Seismic Design of Highway Bridges" (4-1/2-day course), prepared by the Federal Highway Administration, offered by the National Highway Institute
- "Seismic Analysis, Design and Retrofitting of Bridges" (4-day course), prepared by R.A. Imbsen, offered by University Extension, University of California, Berkeley
- "Seismic Retrofit of Bridges" (2-day seminar), prepared by M.J.N. Priestley, F. Seible, and J. Roberts, offered by Department of Applied Mechanics and Engineering Sciences, University of California, San Diego

Further, the Federal Highway Administration is currently seeking proposals under Solicitation No. DTFH-61-91-R-0094 for the development of a training course on the seismic design of bridge foundations.

In general, however, specialty conferences devoted to lifeline earthquake engineering are infrequent. The best example is the series of conferences organized by the American Society of Civil Engineers (ASCE) Technical Council on Lifeline Earthquake Engineering (ASCE/TCLEE). Held at seven-year intervals, three conferences have been convened to date (Los Angeles, 1977; San Francisco, 1984; and Los Angeles, 1991). Topics covered at the Los Angeles meeting included:

- Transportation, electric power, gas and liquid fuel, communication, water and sewer lifelines
- Seismic hazard, reliability, vulnerability, system behavior, mitigation and planning, lifeline performance

## RECOMMENDATIONS FOR LIFELINE SEISMIC STANDARDS

- Fault crossings, large ground deformations, dynamic analysis, experimental projects
- Highway bridges and pipelines

The increasing number of papers and attendees at this sequence of conferences is a reflection of the growing awareness of the importance of the subject and the shortage of information in the existing literature. Other significant symposia include:

- "Recent Developments in Lifeline Earthquake Engineering," held in conjunction with the 1989 Pressure Vessel and Piping Conference in Honolulu, jointly sponsored by the American Society of Mechanical Engineers (ASME), the Japan Society of Mechanical Engineers (JSME), and the National Center for Earthquake Engineering Research (NCEER)
- "Liquefaction, Large Ground Deformation, and Effects on Lifelines," U.S.-Japan Workshops (November 1988, September 1989, and December 1990), sponsored by National Center for Earthquake Engineering Research and Japanese Association for the Development of Earthquake Prediction

In addition to sponsoring national conferences, TCLEE has also produced advisory notes on lifeline earthquake engineering [9]. TCLEE also maintains an Investigation Sub-Committee, which performs reconnaissance work following major earthquakes. A comprehensive training manual has been prepared for committee members to facilitate field investigations related to lifeline performance.

Learning from past earthquakes is a well-recognized strategy for mitigating future damage. In addition to TCLEE's work noted above, several institutions in the United States also perform reconnaissance work. These include, but are not limited to:

- National Research Council, Committee on Natural Disasters
- Earthquake Engineering Research Institute
- National Center for Earthquake Engineering Research
- Interagency Committee on Seismic Safety on Construction
- Disaster Research Center (University of Delaware)

### V-2.2 Standards Plan For Transportation Systems

Seismic standards for both new and existing transportation systems are required. A plan for their development is given in this chapter along with the outline of a research program, which is considered essential to the successful completion of the standards plan.

Figure 5 outlines this plan and shows the relationship between new and existing construction and between research and standards development.

It will be seen that each lifeline standard is in fact composed of four parts: philosophy, system design (or retrofit), component design (or retrofit), and equipment/materials provisions. A critical evaluation and review stage is also included in the plan. Here it is proposed that three sites be chosen from areas of different seismicity (high, moderate, and low) and that each standard be tested for ambiguity, completeness, and cost impact. It will also be seen that an educational component has been included in this plan. Here it is envisaged that instructional

material will be prepared and pilot workshops be held for the purpose of educating design professionals and responsible owners about the implication and application of the new standards. Adoption of these standards as codes may then proceed more rapidly.

The development plan extends over eight years and comprises three distinct phases. These are shown in Table 4 where it will be seen that Phase I includes criteria development and research, Phase II includes the development of the standards themselves, and Phase III is the evaluation, review, and education phase noted above.

Details of the plan, the accompanying research program, schedules, and budgets are given in subsequent sections of this chapter under the headings of new construction (Section 2.3) and existing facilities (Section 2.4). A summary of the overall budget for both sections (new and existing) is given in Table 5. The total cost is estimated to be \$31,310,000 for all eight standards, spread over eight years.

Given limited resources, an argument can be made that standards for new construction should have higher priority than those for the retrofit of existing construction. This argument is based on the relatively poor state of the art in retrofit and that more can be achieved with fewer dollars if they are assigned principally to new construction standards. Also, until the criteria are established for new systems, it is difficult to establish the criteria for retrofit. However, with perhaps the exception of mass-transit facilities, very few new transportation systems will be constructed in the next decade; almost all construction-related activity will be directed toward upgrades and/or expansions of existing facilities. The need for retrofit standards is therefore urgent, and it is accordingly recommended that new and retrofit standards be given *equal* priority.

### **V-2.3 Standards Plan For Design Of New Construction**

#### **V-2.3.1 Scope**

The development of a four-part standard for new transportation systems is not only feasible, but also overdue. A plan for the preparation of these standards is therefore given in this section and further described in Section 2.3.2. A research program to support the development of these standards is given in Section 2.3.3 Schedules, budgets, and personnel are discussed in Section 2.3.4 and priorities are given in Section 2.3.5.

It will be seen that five basic tasks are common to each transportation plan. These tasks are compatible with the need to develop four separate and distinct parts for each standard and the need to test each standard through trial applications in the field. Some tasks also require research projects to be undertaken. Finally, an education and evaluation phase is necessary to aid the implementation of the new standards. In summary these tasks are:

- Develop a philosophy of seismic design that is consistent across all transportation systems
- Develop a performance-based, system-wide standard that shall also consider system interdependence and collocation
- Develop prescriptive component standards
- Develop equipment and material provisions

## RECOMMENDATIONS FOR LIFELINE SEISMIC STANDARDS

- Evaluate the standards through field trials and develop instructional material for use in pilot workshops

It is proposed that for each transportation lifeline, a subcontractor be appointed and an advisory panel of consultants, researchers, and industry representatives be formed. Early in the process a workshop should be held to establish parameters and in particular to lay the foundation for the philosophy statement and the system performance standard. To ensure that consistent philosophies are developed for all transportation lifelines, this workshop (or workshop series) should cover all four systems and be organized by the same agency or subcontractor.

### V-2.3.2 Plan

As noted in Section 2.3.1, each transportation standard will comprise both performance and prescriptive standards. These standards will be developed and evaluated under five tasks, which are described in further detail in this section.

A basic premise used in developing these tasks is that there are both technical and financial reasons for developing transportation standards simultaneously. Technically, every lifeline system should be designed using the same philosophy, i.e., the same seismic criteria and the same expected performance. However, this may not be possible across *all* lifelines, but it should be feasible within the transportation sector. Even here the goal may be elusive if some transportation systems are considered more important than others. This plan assumes that this is not the case and recommends that a consistent approach be used and that to achieve this goal, Tasks 1 and 2 be undertaken simultaneously for all transportation systems.

Further, many components (bridges, walls...) are common to all four transportation modes. Since it is desirable that the same component standards be used regardless of lifeline, this plan is based on the assumption that it is technically feasible to write such a set of component standards. Structures and facilities that are unique to particular lifelines will of course require special treatment, but in general, common standards for common components should be feasible.

While there will be logistic difficulties to such a plan (e.g., obtaining consensus across many different professional boundaries and from many different owner agencies), there are distinct cost savings to be realized if a simultaneous approach is used.

The budgets presented in Section 2.3.4 are based on this premise (i.e., that cost-sharing between lifelines is possible).

#### **Task 1--Philosophy Of Seismic Design**

The underlying philosophy for the seismic design of new transportation systems will be developed under this task. Such a philosophy will determine the levels of seismic risk to be considered in the standards development phase and the expected performance of the various transportation systems. Such performance criteria might be expressed in terms of acceptable loss of function in a given timeframe, which may be formulated in terms of one or more restoration functions.

Performance for different-size earthquakes will be considered, and the need for a dual-level set of criteria will be examined under this task. Such criteria might be based on serviceability requirements for small-to-moderate earthquakes and survival issues (immediate response and recovery) for catastrophic earthquakes. Issues of risk, redundancy, and criticality need to be



rationality addressed in this task.

These standards should be nationally applicable to all four transportation modes, and variations in seismic risk should be accounted for in a rational manner. Uniform seismic risk maps are available and are recommended for use in this exercise.

The principal vehicle for executing this task will be a workshop (perhaps comprising two separate meetings) in which experts will be asked to develop these criteria. Preworkshop position papers should be prepared by selected authors to stimulate and focus discussion.

### **Task 2--System Design Standards**

This task is closely linked to Task 1 and will involve the formulation of a set of four standards that reflect the philosophy developed in Task 1. One standard for each transportation mode (highway, railroad, ports, and air transportation) will need to be developed in which the general philosophy (Task 1) will be customized for each mode. Further, each standard will reflect issues of risk, redundancy, and criticality that are peculiar to that particular mode. It is envisaged that whereas this task will be specific about the required level of system performance, it will not address the mechanics of achieving such performance.

Components that are essential to each particular system will be identified and performance criteria for these components developed. For example, performance criteria for bridges based on acceptable structural damage (no collapsed spans even for major earthquakes) will be developed as subtasks to this task. Other components will be similarly treated under this overall task to ensure consistency of treatment within and between lifelines.

Two additional issues that must also be addressed in this task are the interdependence of lifelines and the added vulnerability of those lifelines that share the same right-of-way.

To adequately address interdependence and collocation, lifelines other than transportation need to be considered (e.g., electric power supply for mass-transit systems, and pipelines, which may be collocated with highways or share bridge crossings).

To avoid undue conservatism in these standards, research is required to define the issues and develop rational criteria that are not only defensible but also cost-effective. Realistic levels of risk need to be determined in this regard. A research program to support this task is described in Section 2.3.3.1.

### **Task 3--Component Design Standards**

Prescriptive standards for the design of various components of transportation systems will be developed under this task. These standards will be consistent with the performance criteria proposed under Task 2.

For components that are common to more than one lifeline, generic standards are proposed. Components in this category include bridges, tunnels, pavements, slopes, retaining structures, and general purpose buildings. Special components and structures, however, will require individual attention. Such components include avalanche and rock shelters, runways, railroads (track), cranes, freight and passenger loading and unloading facilities, platforms, signs, locks, wharves, and special buildings that include, for example, underground structures and control centers for such facilities as air transportation and mass-transit systems.

## RECOMMENDATIONS FOR LIFELINE SEISMIC STANDARDS

With regard to buildings, existing codes such as the Uniform Building Code are judged to be adequate for general purpose buildings. However, these are minimum standards that are primarily intended to save lives. Continuing operability is not an objective of these codes, and significant structural and nonstructural damage must be expected. Special buildings such as those noted above must be designed to remain functional during and after an earthquake, and thus, new building codes, based on serviceability requirements, need to be developed under this task.

Approximately 15 to 20 component standards need to be developed under this task, for the four transportation modes. This total counts the bridge standard (and other generic standards) as one standard even though some customizing will be necessary to meet the unique requirements of each individual lifeline.

Research projects will also be undertaken to support this task in order to permit rational standards to be developed. These projects include work on seismic hazard and ground motions, geotechnical hazards, soil-structure interaction, and structural response as described in Sections 2.3.3.2, 3, and 4 respectively.

### **Task 4--Equipment And Material Provisions**

Prescriptive standards for the design and installation of various items of mechanical and electrical equipment found in transportation systems will be developed under this task. These provisions will be consistent with the performance criteria proposed under Task 2.

For items common to more than one transportation lifeline, generic standards are proposed. Indeed the principal source for these standards is expected to come from nontransportation lifelines where such items are more commonly found (e.g., electric power, gas and liquid fuels, telecommunications, water and sewage). Standards developed or adopted for these lifelines are expected to be generic in nature and to be "portable" to those transportation systems that have these components.

Standards for fuel storage and distribution systems (including electric power distribution) are also to be developed under this task. Again it is expected that these can be obtained from appropriate nontransportation lifelines, and the effort involved here will be one of customizing generic standards to meet the particular requirements of individual transportation facilities.

Material provisions must also be developed at this time. In most instances they will be available from the existing standards literature (for nonseismic applications) and may be incorporated into these lifeline standards by reference. It is expected that those material requirements that are unique to seismic loading will be developed as part of the component standards under Task 3.

### **Task 5--Evaluation And Education**

The final task in this sequence is in two parts: first, an evaluation of the four-part standard, and second, preparation of instructional materials and the conduct of two pilot workshops to introduce the standards to the design profession and responsible officials.

To effectively evaluate each of the transportation standards, it is proposed that three trial sites be selected, one each in a region of high, moderate, and low seismicity. Selected design professionals in each of these areas will be asked to apply the draft standard to a case study and document ease of application, inconsistencies, omissions, ambiguities, and cost impact. An

evaluation of these findings will then be used to modify each standard as appropriate before promoting the standard for consensus review.

An essential step to the eventual adoption of these standards is the education of design engineers and responsible officials. Therefore, the second part of this task will involve the development of instructional material for use in a four- to five-day intensive course, on each of the four new standards. To test the effectiveness of this material, two pilot workshops are proposed (in areas of different seismicity), after which the material may be modified according to student and instructor comments. Again, these two workshops will be offered for each of the four transportation standards. It is noted that the actual cost of holding follow-on courses throughout the United States is considered to be outside the scope of this present exercise.

### V-2.3.3 Research Program

Before definitive standards can be prepared, both basic and fundamental research must be undertaken. A research program is therefore proposed in this plan, which embraces the following topics:

- System vulnerability assessment
- Geotechnical and seismic hazards
- Soil-structure interaction
- Structural response

Examples of research projects to be undertaken in each of these areas are given below. These examples have been assembled from previous research needs workshops, principally the FEMA-sponsored meeting in Denver in 1986 [1]. Proposed funding levels for each area are also given. The total research budget is \$7,760,000.

#### V-2.3.3.1 System Vulnerability

Methodologies for the assessment of lifeline vulnerability to earthquake hazards need to be developed in a consistent format. Such methodologies will be necessary if system design standards that are based on acceptable loss of function and specify maximum restoration times are developed.

The proposed funding level is as follows:

Highways:	\$ 500,000 over 2 years
Railways:	\$ 400,000 over 2 years
Ports and waterways:	\$ 500,000 over 2 years
Airport transportation:	<u>\$ 500,000</u> over 2 years
Subtotal	\$1,900,000

Examples of research topics to be funded under this topic are:

#### **Develop Procedures For Performing Vulnerability Assessments Of Transportation Lifelines**

Procedures that assess the seismic vulnerability of various transportation systems are required. In general, such procedures will use a seismologic and geologic database to estimate intensities of ground shaking for different earthquake scenarios. The impact of such shaking is then

## RECOMMENDATIONS FOR LIFELINE SEISMIC STANDARDS

determined, taking into account structural features, sensitivity to damage, attenuation relationships, and capacity of the affected elements. The development or adoption of component fragility curves is an integral step in this process. To obtain restoration curves, the relationship between degree of damage and repair time needs to be assessed for each of the affected components, as well as the impact of network redundancy on throughput, for varying degrees of damage (to the network). Only very few studies have been completed in this area, and much more remains to be done to develop and apply the methodology to each of the transportation lifelines in turn.

### V-2.3.3.2 Geotechnical And Seismic Hazards

Current research into strong ground motion has been directed toward the determination of force level and frequency content for site-specific situations. Spatial variation in ground motion is largely ignored. However, for those lifeline systems that extend over large distances, such as elevated highways and mass transit systems, it is an important design variable about which little is known. Site response studies, which include soil amplification effects, liquefaction, and the effect of large ground deformation on transportation lifelines, are also required.

The proposed funding level is as follows:

Highways:	\$ 250,000 over 2 years
Railways:	\$ 250,000 over 2 years
Ports and waterways:	\$ 350,000 over 4 years
Air transportation:	<u>\$ 300,000</u> over 2 years
Subtotal	\$1,150,000

Examples of research topics to be supported under this heading are discussed below.

#### **Study Out-Of-Phase Motions And Traveling Wave Effects**

The amount of out-of-phase displacement present over distance comparable to the length of a long bridge is currently unknown. Even more important is the design problem of dealing with these displacements once they become known. Much of this information is available in the seismological community; the rest must be acquired by strong-motion recording. This must be a cooperative project between the seismological and engineering communities. Additional arrays are needed in seismically active regions to supplement existing arrays by the U.S. Geological Survey (USGS) and others to ensure adequate coverage from a large event.

#### **Support Free-Field Strong-Motion Instrumentation, Improved Active Fault Identification, And Improved Fault-To-Site Attenuation Knowledge Nationwide**

To check the results of analyses, develop attenuation relationships and increase the knowledge of structure responses, more complete and extensive information on earthquake shaking is needed. This task should encourage and support strong-motion programs, similar to those in California, throughout the country in areas where earthquakes are expected to occur with some certainty. Some of the instruments should be placed close enough together so that strains can be determined by integrating the accelerations measured and the strain information used to design components of transportation systems.

Identification of active (capable) faults and improved knowledge of fault-to-site attenuation is essential to the continued advance of seismic design. Current efforts should be increased

nationwide. This particularly applies to the area east of the Rocky Mountains.

**Evaluate Liquefaction Hazards To Foundations Of Transportation Structures**

A comprehensive study of liquefaction hazard for both deep and shallow foundations of transportation structures needs to be undertaken. Large ground deformations (which include both translation and rotation) need to be quantified, and analytical models developed for their prediction. Correlation with field observations should be undertaken. Factors affecting ground deformation need to be identified so as to assist with site selection and/or to determine the feasibility of site stabilization.

**V-2.3.3.3 Soil-Structure Interaction**

Soil-structure interaction is a key component in the seismic response of many transportation elements. Nevertheless, little is known about the topic, and considerable research remains to be done before adequate standards and design procedures can be formulated. Issues that will be addressed under this part of the research program include piled foundations, underground structures, retaining structures, wharves, and bridge abutments.

The proposed funding level is as follows:

Highways:	\$ 500,000 over 4 years
Railways:	\$ 850,000 over 4 years
Ports and waterways:	<u>\$ 700,000</u> over 4 years
Subtotal	\$2,050,000

Examples of research topics to be supported under this heading are described below.

**Perform Soil-Structure Interaction Tests**

Some limited experimental research on soil-structure interaction of bridges has been conducted, and it has provided insight into the interaction phenomenon. However, some important issues are still unresolved. These include the interaction between backfill soils and rigid and flexible abutment walls. Of particular interest are the active and passive pressure distributions, and the stiffness and damping characteristics of these foundation elements. Further experimental study of the dynamic interaction of piles, pile bents, and piers also should be undertaken to better understand their stiffness and damping characteristics during moderate and high levels of excitation.

Although some tests (mostly static and cyclic) have been conducted on some of these types of foundations for other applications (e.g., offshore platforms and retaining walls), dynamic tests need to be conducted on typical bridges with these foundations, prototype models of these foundations, and small-scale models. The advantages of full-scale and prototype testing are well established. The testing of small-scale models has recently become much more viable and attractive, especially with the advent of geotechnical centrifuges, which are being increasingly used to study a variety of complex soil-structure interaction problems.

**Develop Methods To Estimate Soil Failure**

From the standpoint of the stability of bridge foundations, a topic requiring further research is the phenomenon of soil failure. For example, the ultimate load and stress distribution imparted by an

## *RECOMMENDATIONS FOR LIFELINE SEISMIC STANDARDS*

abutment to the adjacent backfill soil prior to the soil's failure is not well known. The ultimate loads and capacities of pile and pier foundations during static and dynamic loading is also uncertain. It is generally acknowledged that the ultimate capacity of foundations is much more uncertain than the ultimate capacity of the superstructures. This is true for all types of structures.

However, to reduce the suspected conservatism inherent in bridge foundation design, more research must be conducted on the ultimate capacity of a variety of bridge foundations founded on different types of soils, including saturated cohesionless soils that are prevalent at many river crossings. The testing to failure of prototype foundations in the field or scale models in the centrifuge is recommended to obtain a better understanding of the failure mechanisms and ultimate loads. More research on constitutive modeling at high strain levels is also appropriate.

### **Evaluate Past Performance Of Embankments And Retaining Structures**

Earthquake damage to ports and waterways frequently occurs when there are deficiencies in slope stability of embankments or cuts, and failure in waterfront earth-retaining structures (retaining walls, bulkheads, cofferdams, relieving platforms, caissons, etc.). These can occur above or below water, but the greatest risks are clearly in the area of underwater slopes and submerged retaining structures. These risks include liquefaction in loose, cohesionless soils due to porewater pressure effects and shear failures or excessive settlements in cohesive soils.

It is recommended that information be collected from most recent earthquakes on the behavior of soil materials, where failure did or did not occur, and on the effectiveness of soil improvement techniques. Much of this information is applicable to foundations for other transportation facilities.

### **Develop Analytical Methods For Embankments And Retaining Structures**

To reduce potential failures of slopes and retaining structures due to earthquakes, significant research efforts are needed for the further development of experimental and analytical procedures and for the evaluation of current methods of seismic analysis in the following areas: (1) prediction of possible occurrence and extent of soil failures, (2) soil improvement techniques (vibratory, compaction, etc.), (3) detailed evaluation of existing procedures and development of improved procedures for estimating earthquake-induced lateral pressures on retaining structures, and (4) soil-structure interaction analyses that incorporate porewater pressure effects under two-dimensional and three-dimensional conditions.

### **Evaluate Past Performance Of Underground Structures**

Underground transportation structures include tunnels, terminal structures (i.e., stations), and cut-and-cover structures. These are key elements in highway, railroad, and urban mass transit systems. Underground transportation structures have historically performed well in strong earthquake environments. However, there are many examples of highly used underground highway and railroad tunnels in seismic regions for which severe earthquakes could threaten the life safety of users as well as the post-earthquake recovery of the region. Extensive underground mass transit systems in earthquake-prone regions are now under construction (e.g., in Los Angeles and Boston).

It is important to carefully evaluate all existing earthquake performance data for underground structures and systems to assess (1) reasons why particular underground systems have exhibited favorable seismic performance (e.g., the Mexico City Metro during the 1985 Mexico City earthquake), (2) conditions of ground shaking and/or site conditions that might lead to less

favorable performance, and (3) the behavior in potentially critical regions of underground system structures (e.g., portals, tunnel/station interfaces).

**Utilize Detailed Analysis Techniques To Evaluate Underground Structures**

Two-dimensional and three-dimensional finite element techniques, although expensive, are particularly well suited for evaluating the behavior of underground structures in a strong earthquake environment. Such techniques should be used to evaluate and develop guidelines for the following aspects of underground structure behavior that are not well known to practicing engineers: (1) medium-structure interaction effects at tunnel-station interfaces or other locations of stiff structural elements; (2) effects of geologic discontinuities on the behavior of underground structures of extended length; (3) effects of through-soil interaction between buildings and underground subway structures; (4) depth-dependent effects on the behavior of underground structures; and (5) conditions leading to earthquake-induced spalling, rock fall, rock joint openings, and block motion for unlined tunnels in rock or cracking, spalling, and liner failure for lined tunnels.

**Develop Experimental Procedures To Evaluate Full-Scale Underground Structures**

A major potential source of damage to underground structures may be associated with rock or soil slides, liquefaction, soil subsidence, etc., particularly at portals and in shallow excavations. Accordingly, the continued development of experimental procedures for gaining further insight into the potential for occurrence of these soil and rock instabilities at a given location is recommended. Such experimental evaluations should be supplemented by analytical studies and the compilation of data from past earthquakes.

**V-2.3.3.4 Structural Response**

Although significant progress has been made toward understanding the structural response of conventional buildings, the same progress has not been made for lifeline structures. In particular, the performance of long-span bridges, multispan elevated structures, rail bridges, joints, connections and intersections in large structural sections, container cranes, vessel berths, and passenger and freight loading/unloading systems need attention. Further the protection of nonstructural components and contents in buildings that house control centers and sensitive equipment needs immediate study.

The proposed funding level is as follows:

Highways:	\$ 800,000 over 4 years
Railways:	\$ 900,000 over 3 years
Ports and waterways:	\$ 400,000 over 3 years
Air transportation:	<u>\$ 560,000</u> over 3 years
Subtotal	\$2,660,000

Examples of research topics to be supported under this heading include:

**Conduct Full-Scale Tests On Individual Bridge Columns**

Several mathematical idealizations have been proposed to model the nonlinear behavior and

## *RECOMMENDATIONS FOR LIFELINE SEISMIC STANDARDS*

energy dissipation that occurs in a ductile bridge column. Unfortunately, there is a shortage of physical test data on the large reinforced concrete columns typically used in bridges. Additional testing is needed on large reinforced concrete bridge columns to subject them to axial loads and bi-directional lateral displacements similar to those experienced during earthquakes.

### **Conduct Full-Scale Laboratory Tests On Skewed Multiple-Column Bridge Bents**

The overall response of a bridge system is affected by the behavior of the individual components. Multiple-column bents are often used in bridges having skewed supports. Reports on earthquake damage to bridges indicate that bridges supported on skewed supports are more vulnerable to damage because of the tendency of the bridge to respond in a horizontal rotational mode as well as in longitudinal and transverse translations. This overall response, which is characteristic of skewed bridges, should be investigated in greater detail by conducting model studies on shake tables. A prerequisite, however, to the model tests is a definition of the behavior of the multi-column bent. In addition, the effect of enhanced vertical loads on the exterior columns and the influence of this effect on the response of the column should be evaluated. The current design specification for highway bridges includes a provision for reducing the design forces in accordance with the plastic hinging that is expected to occur in the columns of a multicolumn bent. This reduction factor should be verified by physical testing.

### **Conduct Full-Scale Laboratory Tests On Typical Bridge Support And Hinge Connections**

The primary areas of a bridge vulnerable to earthquake damage are the discontinuities at support and hinge connections. The majority of collapse failures are caused by large movements in these areas, and the overall dynamic response of a bridge is greatly affected by the discontinuity in these areas. Depending on the bearing, these connections may be characterized by a combination of several types of nonlinear behavior that include impacting, sliding, and yielding. Physical data on the behavior of these connections at present are nonexistent and are needed for improved modeling and analysis.

### **Conduct Full-Scale In-Situ Tests On Bridge Abutments And Roadway Embankments**

The interaction of the bridge with the roadway embankment is an exceptionally complicated problem. Very little information is currently available to assist the designer in determining the influence of the abutment foundation and roadway embankment on the overall seismic response of the bridge. Full-scale tests on prototype bridge abutments constructed on earth-fill embankments should be conducted. In many cases, bridge abutments that are constructed prior to the completion of the bridge superstructure may be utilized for such a test. This would provide an economical opportunity to test the abutment full-scale.

### **Evaluate Past Performance Of Vessel Berths**

Earthquake hazards to freestanding vessel berths (those that are not also retaining structures) will depend in large measure on the dead weight of the structures and their resistance to lateral forces. In addition, there are hazards associated with cargo-handling equipment and storage installations supported by all types of structures. Severe damage has been reported during recent earthquakes in Latin American ports due to the collapse of rail-mounted cranes, elevated conveyor belt



supports, and the headhouse structures and weighing scales of a large grain terminal. Accordingly, information should be collected on the performance of such elements in past earthquakes to identify the conditions under which damage did and did not occur.

### **Develop Seismic Design Methods For Vessel Berths**

There is a need to investigate the potential impact of tsunamis on vessel berths (such as those associated with the September 1985 earthquake in Mexico). While vessels are tied up during loading and unloading operations, it cannot be assumed that there will be advance warning of tsunamis that may be created by nearby earthquakes; therefore, it may not be feasible to adjust or to have vessels clear berths before the tsunami hits. Major damage to both vessels and berth structures is therefore possible. Very little is known on this subject.

The response of rail-mounted mobile cranes to earthquakes is another critical issue. While resistance to wind forces is normally provided, research is recommended to gain further insight into the dynamic seismic response characteristics of cranes and to establish a basis for appropriate design criteria and safe operating procedures in earthquake areas. This is particularly relevant for high-capacity bulk loaders and modern container-handling cranes. These are associated with heavy loads at high elevations, wide gauges (up to 30 m), and major capital investments. Their resistance to overturning due to ground shaking and the stresses that could be induced by differential movements of rail supports could be critical.

### **Develop Methods For The Protection Of Contents In Essential Buildings**

Current building codes are life-safety oriented and do not prevent the occurrence of secondary damage in even small-to-moderate earthquakes. For large earthquakes collapse will be prevented but major structural damage must be expected. Heavy losses to building contents must also be expected under these circumstances, which if the building is essential for response and recovery following a disaster, will be an unacceptable situation. Such essential buildings include control towers at airports, the air route transportation control centers, telecommunication installations, computer facilities, navigational centers, and other traffic control centers.

Conventional methodologies involve adding strength to the building, the bracing of equipment, making design modifications to equipment to ensure continued operation and the restraint of non-structural components such as partition walls and ceiling fixtures. Nonconventional techniques involve using passive and/or active control systems to protect either the complete building, parts of the building (isolated floor systems) or individual items of equipment. Much research is required to develop cost-effective strategies for contents protection in this neglected area of building design.

#### **V-2.3.4 Budgets, Schedules, And Personnel**

Tables 6 and 7 present summary budgets and schedules for the development of these standards and include the cost of the supporting research program described above. Detailed schedules and budgets for individual lifelines are given in the Appendix.

The following assumptions have been made when preparing these tables:

- The level of effort required for standards development for lifelines can be judged from similar experience in parallel fields (e.g., in buildings) modified by the availability of existing knowledge and the perceived difficulty of achieving the

## RECOMMENDATIONS FOR LIFELINE SEISMIC STANDARDS

stated objective.

- Each person-year of effort costs \$100,000.
- Cost sharing between lifelines is available.
- The cost ratio between research effort and standards development (for new construction) is approximately 4:1 based on Federal Highway Administration experience with developing seismic design criteria for bridges.

It will be seen from Table 6 that the total cost for all four lifelines is \$12,720,000, which includes \$4,960,000 for standards development and \$7,760,000 for research. It is noted that the research subtotal is less than that estimated in 1986 (\$11,745,000 for transportation lifelines research, excluding retrofit [1]), but this earlier figure included several research needs that are not judged to be essential to the development of standards.

Schedules showing duration and budget allocations by year are given in Table 7. Both the research program and the standards plan are shown in this table. An eight-year schedule is presented that, as illustrated in Table 4, comprises three phases as follows:

- Phase I--Years 1-4: research program and criteria development
- Phase II--Years 3-5: standards development
- Phase III--Years 6-8: evaluation and education

Personnel are listed below by agency/institution. Two categories are used to classify these agencies; those that are system dependent and those that have expertise in more than one system or lifeline.

- System Independent
  - National Institute of Standards and Technology
  - ASCE - Technical Council on Lifeline Earthquake Engineering
  - National Center for Earthquake Engineering Research
  - Applied Technology Council
- System Dependent
  - Federal Highway Administration
  - American Association of State Highway and Transportation Officials
  - National Cooperative Highway Research Program
  - Federal Railway Administration
  - Urban Mass Transportation Administration
  - American Railway Engineering Association
  - Coast Guard
  - American Association of Port Authorities
  - American Waterway Operators
  - Federal Aviation Administration
  - American Association of Airport Executives

### V-2.3.5 Priorities For New Construction Standards

Priorities need to be set between new and retrofit construction and then, within new construction, between the various tasks of the standards development plan.

Given limited resources, an argument can be made that standards for new construction should have higher priority over those for the retrofit of existing construction. This argument is based on the relatively poor state of the art in retrofit and that more can be achieved with fewer dollars if they are assigned principally to new construction standards. Also, until the criteria are established for new systems, it is difficult to establish the criteria for retrofit. However, with perhaps the exception of mass-transit facilities very few new transportation systems will be constructed in the next decade; almost all construction-related activity will be directed toward upgrades and/or expansions of existing facilities. Therefore, the need for retrofit standards is urgent, and it is accordingly recommended that new and retrofit standards be given *equal* priority.

For new construction, priorities are given in Table 8. Since it is strongly recommended that all four transportation modes be studied simultaneously, no priorities have been assigned between the four individual lifelines (highways, railways, ports, and air transportation facilities).

## V-2.4 Standards Plan For Retrofit Of Existing Facilities

### V-2.4.1 Scope

The development of a four-part standard for retrofitting each of the transportation lifelines follows the concept of the plan for new construction standards outlined in Section 2.3. This plan is described in Section 2.4.2. A research program is proposed in Section 2.4.3, which focuses on the need to provide basic information on evaluation and strengthening as well as to develop manuals of practice for seismic retrofit.

This program is complementary to that already proposed for new construction. Schedules and budgets are discussed in Section 2.4.4 and priorities are given in Section 2.4.5.

Five basic tasks (similar to those developed in the plan for the design of new construction) comprise this retrofit plan, as follows:

1. Develop a philosophy of seismic retrofit that is consistent across all transportation systems
2. Develop a performance-based, system-wide standard that shall also consider system interdependence and collocation
3. Develop prescriptive component standards
4. Develop equipment and material provisions
5. Evaluate the standards through field trials and develop instructional material for use in pilot workshops

Just as for the new design standards, a subcontractor should be appointed, along with an advisory panel of consultants, researchers and industry representatives, to guide the development of these retrofit standards.

## *RECOMMENDATIONS FOR LIFELINE SEISMIC STANDARDS*

### **V-2.4.2 Plan**

As noted in Section 2.4.1, each retrofit standard will comprise both performance and prescriptive standards. These standards will be developed and evaluated under five tasks, which are described in further detail in this section.

In developing this retrofit plan, two assumptions were made. First, that it is feasible to develop the philosophy and system retrofit standards for all four transportation lifelines simultaneously. A similar position was taken in this regard in Section 2.3.2 for new construction. Second, that even though many components (e.g., bridges, walls) are common to all transportation modes, there are sufficient differences in existing construction (e.g., age, condition, material types, structural form) to warrant separate retrofit standards for the components of each transportation lifeline. This is the opposite of the position taken for new construction in Section 2.3.2.

Whereas the cost-savings might not be as dramatic as for the development of a common set of standards, there are cost-sharing opportunities between the development of retrofit and new construction standards, and this has been assumed when preparing the budget in Section 2.4.5.

#### **Task 6--Philosophy Of Seismic Retrofit**

The underlying philosophy for the seismic design of retrofit of existing transportation systems will be developed under this task. Such a philosophy will determine the levels of seismic risk to be considered in the standards development phase and the expected performance of the various transportation systems. Such performance criteria might be expressed in terms of acceptable loss of function in a given timeframe, which may be formulated in terms of one or more restoration functions.

Performance for different-sized earthquakes will be considered, and the need for a dual-level set of criteria will be examined under this task. Such criteria might be based on serviceability requirements for small-to-moderate earthquakes and survival issues (immediate response and recovery) for catastrophic earthquakes. Issues of risk, redundancy, and criticality need to be rationally addressed in this task.

It is expected that the performance requirements for retrofitted systems and components will not be the same as for new construction. Instead, various classes of retrofit will be defined, ranging from a minimum performance level (less than new construction) to a superior performance level (better than new construction). These classes will be defined during this task.

These standards should be nationally applicable to all four transportation modes, and variations in seismic risk should be accounted for in a rational manner. Uniform seismic-risk maps are available and are recommended for use in this exercise.

The principal vehicle for executing this task will be a workshop (perhaps comprising two separate meetings) in which experts will be asked to develop these criteria. Preworkshop position papers should be prepared by selected authors to stimulate and focus discussion.

#### **Task 7--System Retrofit Standards**

This task is closely linked to Task 6 and will involve the formulation of a set of four standards that reflect the philosophy developed in Task 6. One standard for each transportation mode (highway, railroad, ports, and air transportation) will need to be developed in which the general

## TRANSPORTATION LIFELINES

philosophy (Task 6) will be customized for each mode. Further, each standard will reflect issues of risk, redundancy, and criticality that are peculiar to that particular mode. It is envisaged that whereas this task will be specific about the required level of system performance, it will not address the mechanics of achieving such performance.

Components that are essential to each particular system will be identified, and performance criteria for these components developed. For example, performance criteria for bridges based on acceptable structural damage (no collapsed spans even for major earthquakes) will be developed as subtasks to this task. Other components will be similarly treated under this overall task to ensure consistency of treatment within and between lifelines.

Two additional issues that must also be addressed in this task are the interdependence of lifelines and the added vulnerability of those lifelines that share the same right-of-way.

To adequately address interdependence and collocation, lifelines other than transportation need to be considered (e.g., electric power supply for mass-transit systems, and pipelines, which may be collocated with highways or share bridge crossings).

Research is required to support this task, particularly in the area of system vulnerability assessment, which will include the development of methodologies for prioritizing the retrofit of system components.

### **Task 8--Component Retrofit Standards**

Prescriptive standards for the retrofit of various components of transportation systems will be developed under this task. These standards will be consistent with the performance criteria proposed under Task 7.

Components in this category include bridges, tunnels, pavements, slopes, retaining structures, and general purpose buildings. Special components and structures, however, will require additional attention. Such components include avalanche and rock shelters, runways, railroads (track), cranes, freight and passenger loading and unloading facilities, platforms, signs, locks, wharves, and special buildings that include, for example, underground structures and control centers for such facilities as air transportation, and mass-transit systems.

With regard to buildings, existing retrofit guidelines for evaluation and repair are judged to be adequate for general purpose buildings. However, these are minimum standards that are primarily intended to save lives. Continuing operability is not an objective of these guidelines, and significant structural and nonstructural damage must still be expected. Special buildings such as those noted above must be designed to remain functional during and after an earthquake, and thus, retrofit criteria, based on serviceability requirements, need to be developed under this task.

Approximately 50 to 60 component standards need to be developed under this task, for the four transportation modes.

Research projects will also be undertaken to support this objective in order to permit rational standards to be developed. These projects include work on evaluation and strengthening of existing systems as well as the development of guidelines and manuals for the seismic retrofit of lifelines.

## RECOMMENDATIONS FOR LIFELINE SEISMIC STANDARDS

### **Task 9--Equipment And Material Provisions**

Prescriptive standards for the design and installation of various items of mechanical and electrical equipment found in transportation systems will be developed under this task. These provisions will be consistent with the performance criteria proposed under Task 7.

For items common to more than one transportation lifeline, generic retrofit standards are proposed. Indeed the principal source for these standards is expected to come from nontransportation lifelines where such items are more commonly found (e.g., electric power, gas and liquid fuels, telecommunications, water and sewage). Standards developed or adopted for these lifelines are expected to be generic in nature and to be "portable" to those transportation systems which have these components.

Retrofit standards for fuel storage and distribution systems (including electric power distribution) are also to be developed under this task. Again it is expected that these can be obtained from appropriate nontransportation lifelines, and the effort involved here will be one of customizing generic standards to meet the particular requirements of individual transportation facilities.

Material provisions must also be developed at this time. In most instances they will be available from the existing standards literature (for non-seismic applications) and may be incorporated into these lifeline standards by reference. It is expected that those material requirements that are unique to seismic loading will be developed as part of the component standards under Task 3.

### **Task 10--Evaluation And Education**

The final task in this sequence is in two parts: first, an evaluation of the four-part standard, and second, preparation of instructional materials and the conduct of two pilot workshops to introduce the standards to the design profession and responsible officials.

To effectively evaluate each of the transportation standards, it is proposed that three trial sites be selected, one each in a region of high, moderate, and low seismicity. Selected design professionals in each of these areas will be asked to apply the draft standard to a case study and document ease of application, inconsistencies, omissions, ambiguities, and cost impact. An evaluation of these findings will then be used to modify each standard as appropriate before promoting the standard for consensus review.

An essential step to the eventual adoption of these standards is the education of design engineers and responsible officials. Therefore, the second part of this task will involve the development of instructional material for use in a four- to five-day intensive course, on each of the four new standards. To test the effectiveness of this material, two pilot workshops are proposed (in areas of different seismicity), after which the material may be modified according to student and instructor comments. Again, these two workshops will be offered for each of the four transportation standards. It is noted that the actual cost of holding follow-on courses throughout the United States is considered to be outside the scope of this present exercise.

#### **V-2.4.3 Research Program**

As noted above an aggressive research program is necessary to support the development and implementation of these retrofit standards. The program proposed in this plan therefore embraces the following topics:

- Acceptable performance criteria
- Vulnerability assessment
- Evaluation of existing capacity
- Strengthening of existing systems and components
- Guidelines and manuals for the retrofit of existing transportation systems

The proposed funding level is as follows:

Highways:	\$ 3,750,000
Railways:	\$ 4,650,000
Ports and waterways:	\$ 3,750,000
Air transportation:	<u>\$ 2,500,000</u>
Subtotal	\$14,650,000

Examples of research projects to be undertaken in each of these areas are given below. These examples have been assembled from previous research needs workshops, principally the FEMA-sponsored meeting in Denver in 1986 [1].

#### **V-2.4.3.1 Performance Criteria**

##### **Develop Acceptable Performance Criteria For Strengthened Facilities**

Normally, it is not feasible to strengthen an existing facility to meet the requirements of codes for new construction. Such strengthening is, in many cases, simply impossible, if not prohibitively expensive. Criteria that define acceptable performance for strengthened facilities currently do not exist. Such criteria, however, are essential for effective implementation of seismic strengthening programs nationwide. These criteria must acknowledge the fact that previously constructed facilities may not conform to the applicable construction documents, must define acceptable damage and loss of function, and must address the issue of acceptable risk.

This project seeks to develop the required performance criteria for strengthened facilities. These criteria can best be developed in a project involving qualified and knowledgeable engineers, researchers, and legal representatives from all regions of the country. Issues that must be addressed include (1) justification for strengthening a facility to a performance level less than the current code requirement, (2) potential liabilities and limitations on liability, and (3) acceptable loss of function after strengthening.

##### **V-2.4.3.2 Vulnerability Assessment Of Existing Systems**

In addition to the research needs previously described under this heading for new construction (Section 2.3.3.1), methods to assign retrofit priorities and procedures for preliminary screening of transportation facilities also need to be developed.

##### **Develop Criteria For Setting Retrofit Priorities**

Numerous factors affect the decision to strengthen individual or groups of facilities. These include site conditions, structural characteristics, seismic exposure, required seismic-resistance capacity, and importance. To help local jurisdictions concentrate their efforts and resources on those facilities that should be strengthened first, a consistent means for setting priorities for strengthening should be established.

## RECOMMENDATIONS FOR LIFELINE SEISMIC STANDARDS

A methodology has been developed for bridges, and this provides a useful starting point for other facilities. Agreement on the criteria should be reached through a comprehensive development and review process, involving experienced earthquake engineers from all regions of the country.

### **Develop Preliminary Screening Procedures**

Facilities identified as potentially hazardous must be screened to identify those that require a more detailed assessment. This evaluation requires a review of construction documents and the general condition of the facility as well as some simple calculations. Ideally, approximately one to three engineer-days of effort per facility would be required for this preliminary evaluation. A methodology has been developed for bridges, but this must be extended to other facilities.

Current techniques need to be studied and applied experimentally to a sample of existing facilities so that an optimum technique can be developed. This should lead to a nationally applicable methodology capable of producing comparable results in different seismic zones.

Verification of the proposed methodology can be accomplished by its use on selected samples of facilities in various locations that have previously undergone both preliminary and detailed evaluation for other purposes. The suitability of the proposed preliminary evaluation procedure can thus be established by comparing its results with the results of detailed evaluations. Data representing a large sample of facilities are needed, however, and the verification process should be guided by a team or panel of specialists from all regions of the country who have extensive experience in evaluating earthquake threats to facilities.

Any proposed methodology verified as suitable should be documented in a simple and concise format written specifically for design professionals and local authorities.

### **V-2.4.3.3 Evaluation Of Existing Systems**

#### **Determine The Strength And Deformation Characteristics Of Existing Facilities And Components**

Most experimental research on the strength/deformation characteristics of structural components and systems during the past decade has been directed at new components and systems. The priorities for supplemental experimental research on existing components need to be identified. The initial phase of this project should therefore involve a workshop at which the experimental needs would be determined. Following this workshop, a series of laboratory and full-scale experiments should be performed to establish the strength and deformation characteristics (to failure) of connections, components, and systems common to existing facilities.

#### **Evaluate And Develop Field Condition Assessments**

Structural engineering plans often are not available for existing facilities. Even if such plans exist, the facility may differ significantly from the original design plans. Therefore, a critical part of the evaluation process is assessing the current condition of the facility. Appropriate equipment and techniques for in-situ evaluation of the strength and condition of materials should be evaluated and new options fostered.

The initial step in this project should be a workshop or seminar to identify currently available evaluation techniques and instrumentation. Requirements for improved techniques and



instrumentation should be identified. Subsequent portions of this project should be devoted to research and development of new instrumentation by manufacturers and improved techniques for visual assessment and measurement.

#### **V-2.4.3.4 Strengthening Of Existing Systems**

##### **Identify Practical And Effective Strengthening Methods**

Structural engineers currently use a variety of techniques to strengthen the seismic resistance capabilities of existing facilities. Many of these techniques are developed separately by structural engineering firms on an ad-hoc basis because little information on practical and cost-effective strengthening techniques is available to the profession at large. This lack of available information reflects both the fact that existing strengthening techniques have not been assessed for practicality and effectiveness and that measures do not exist within the structural engineering profession for effectively transferring technical information on strengthening techniques.

This task seeks to assess currently available seismic strengthening techniques in terms of practicality and effectiveness. The assessment process should consist of a compilation of existing techniques followed by an in-depth evaluation of individual techniques. The results of the evaluations should be presented and discussed in a workshop attended by experienced design professionals from all regions of the United States. The ultimate goal of the subtask is to rank existing methods in order of practicality and effectiveness on the basis of expert engineering opinion.

Examples of practical methods that can be evaluated include (1) procedures for retrofitting underground structures against ground failure effects and soil-improvement methods that reduce the potential for future earthquake-induced ground failures at underground structures sites, (2) procedures for retrofitting underground structures damaged by earthquake-induced fault displacement, (3) retrofit procedures for large rail-mounted cranes, and (4) retrofit procedures for viaducts and other large bridge structures.

##### **Conduct Experimental Research To Determine Performance Of Strengthened Facilities**

Following the identification of practical retrofit methods, full-scale field experiments, or large-scale laboratory experiments, need to be performed on those strengthening techniques considered to be most practical and effective in order to verify their strength and deformation characteristics. It is only through such experiments that information on reliability, structural integrity, and possible failure modes can be established. The laboratory and field investigations should be conducted on a cooperative basis involving design engineers and researchers to ensure that the most effective research techniques and design considerations are used.

#### **V-2.4.3.5 Guidelines And Manuals For Seismic Retrofitting**

##### **Prepare State-Of-The-Art Detailed Evaluation Guidelines**

This document should be based on the information developed under the above research projects on evaluation as well as previously developed systems and should include discussions and methods for handling all aspects of the evaluation process. For example, the guidelines should include a method for determining the parameters that characterize the seismic environment (e.g., response spectra, estimates of strong-motion duration, and other factors), discussions of the form

## RECOMMENDATIONS FOR LIFELINE SEISMIC STANDARDS

and accuracy of the equations used to estimate loads, methods for determining and evaluating capacities and deformations, and information on acceptable levels of damage and risk. The guidelines should be applicable to all types of existing facilities.

### **Prepare State-Of-The-Art Guidelines For Seismic Strengthening**

This document should be based on the information developed under the above research projects on strengthening and is intended to provide comprehensive state-of-the-art guidelines for designing appropriate seismic strengthening measures for all major types of existing hazardous transportation facilities nationwide. Optimal technical details are not expected to be fully available at the time the document is developed; nevertheless, the document is required in order to provide the practitioner with usable information on the most effective ways to strengthen the facilities.

To ensure acceptance of the seismic strengthening guidelines by the profession at large, it is essential that the guidelines be developed through a comprehensive review and revision process involving experienced and qualified earthquake engineers from all regions of the country. The guidelines should be written in a concise format and made available to practicing design professionals nationwide.

### **Develop Cost Estimates For Alternative Strengthening Techniques**

Essential ingredients of any local strengthening program are reliable data on the costs involved in strengthening existing facilities. Such costs will largely determine the political resolution of decisions concerning the development and implementation of viable strengthening programs. Estimation of these costs must be related to the proposed standards, composition of the inventory, and seismic exposure. Such estimates also are necessary before public financial proposals can be prepared.

This project will involve compilation and assessment of cost data on facilities already strengthened. The results should be applicable nationwide.

#### **V-2.4.4 Budgets, Schedules, And Personnel**

Tables 9 and 10 present summary budgets and schedules for the development of these standards and include the cost of the supporting research program described above.

The following assumptions have been made when preparing these tables:

- The level of effort required for standards development for existing lifelines can be judged from similar experience in parallel fields (e.g., buildings) adjusted for the lack of existing knowledge and experience in this field.
- Each person-year of effort costs \$100,000.
- Cost sharing between lifelines is available.
- The cost ratio between research effort and standards development (for existing facilities) is approximately 9:1 based on Federal Highway Administration (FHWA) experience for new standards (Section 2.3.4) and California Department of Transportation (CalTrans) experience with bridge retrofit (see below).

## TRANSPORTATION LIFELINES

It will be seen from Table 9 that the total cost for all four lifelines is \$18,590,000, which includes \$3,940,000 for standards development and \$14,650,000 for research. It is noted that this latter figure is more than that estimated in 1986 (\$10,355,000 [1]), but this earlier figure did not specifically address several issues considered in this plan (e.g., airports and air transportation systems). It is also noted that the above figure for research expenditure (which averages \$3.66 million over 4 years) is less than current CalTrans expenditure on bridge retrofit research, which is approximately \$5 million per year.

Schedules showing duration and budget allocations by year are given in Table 10. Both the research program and the standards plan are shown in this table.

An eight-year schedule is presented, which, as illustrated in Table 4, comprises three phases as follows:

- Phase I--Years 1-4: research program and criteria development
- Phase II--Years 3-5: standards development
- Phase III--Years 6-8: evaluation and education

Personnel are listed below by agency/institution. Two categories are used to classify these agencies: those that are system dependent and those that have expertise in more than one system or lifeline.

- System Independent
  - National Institute of Standards and Technology
  - ASCE - Technical Council on Lifeline Earthquake Engineering
  - National Center for Earthquake Engineering Research
  - Applied Technology Council
- System Dependent
  - Federal Highway Administration
  - American Association of State Highway and Transportation Officials
  - National Cooperative Highway Research Program
  - Federal Railway Administration
  - Urban Mass Transportation Administration
  - American Railway Engineering Association
  - Coast Guard
  - American Association of Port Authorities
  - American Waterway Operators
  - Federal Aviation Administration
  - American Association of Airport Executives

### V-2.4.5 Priorities For Existing Construction Standards

As previously discussed in Section 2.3.5, which concerns priorities for new construction standards, equal priority between standards development for new and retrofit construction is recommended.

Within the retrofit plan, priorities are assigned as in Table 11.

## RECOMMENDATIONS FOR LIFELINE SEISMIC STANDARDS

### V-3. ACKNOWLEDGMENTS

The contribution of the following expert reviewers to the content of this plan is gratefully acknowledged: James D. Cooper, James H. Gates, Geoffrey R. Martin, James E. Monsees, and Stuart D. Werner.

### V-4. REFERENCES

1. "Abatement of Seismic Hazards to Lifelines: An Action Plan," Report FEMA-142, Federal Emergency Management Agency, 1987, 239pp.
2. "Strategies and Approaches for Implementing a Comprehensive Program to Mitigate the Risk to Lifelines From Earthquakes and Other Natural Hazards," Ad Hoc Panel on Lifelines Report, National Institute of Building Sciences, 1989, 59pp.
3. Fratto, Edmund S., "Legal Issues and Regulatory Approaches in Abatement of Seismic Hazards to Lifelines," Abatement of Seismic Hazards to Lifelines: Proceedings of a Workshop on Development of an Action Plan, Volume 6. Washington, D.C.: FEMA, 1987.
4. National Public Works Council, "The Nation's Public Works, Defining the Issues." Washington, D.C.: National Public Works Council, 1986.
5. Dikkers, R.D., "Standards...Tools for Excellence," *Corrections Today*, American Correctional Association, April 1987.
6. "Standard Specifications for Highway Bridges," American Association of State Highway and Transportation Officials, 14 Edition 1989, with Interims 1990 and 1991.
7. "Competing Against Time," Report of the Governors Board of Inquiry on the 1989 Loma Prieta Earthquake (George Housner, Chairman), 1990, 264pp.
8. "Seismic Retrofitting Guidelines for Highway Bridges," Report ATC-6-2, Applied Technology Council, 1983. Also published by Federal Highway Administration as Report FHWA/RD-83/007, 1983.
9. "Advisory Notes on Lifeline Earthquake Engineering," Technical Council on Lifeline Earthquake Engineering, American Society of Civil Engineers, New York, New York, 1983.
10. Pauschke, J.M., "Seismic Hazard Abatement of Railroad Facilities," Proc. Workshop on Development of an Action Plan, Volume 6, Washington, D.C., FEMA, 1987.
11. Roberts, J.E. and R.E. Kershaw, "Seismic Design for the Sacramento Light Rail Transit System," Proceedings, Lifeline Earthquake Engineering: Performance, Design and Construction, San Francisco, CA, October 4-5, 1984, pp. 35-51.
12. "Loma Prieta Reconnaissance Report," Supplement to Volume 6, Earthquake Spectra, Journal Earthquake Engineering Research Institute, May 1990.

TRANSPORTATION LIFELINES

**TABLE 1**  
**PARTIAL INVENTORY OF TRANSPORTATION FACILITIES**  
**IN THE UNITED STATES**

LIFELINE	SIZE/NUMBER	COMPONENT
Roadways	3,200,000	Rural Road Miles (3)
	683,000	Urban Street Miles (3)
	834,500	Highway Miles (4)
	574,000	Bridges (4)
Mass Transit	6,900	Rail Miles (4)
Waterways	25,500	Miles (3)
	2,400	Marine Terminals (3)
	225	Locks (3)
	270	Waterway Dams (3)
Airports	14,500	Airports (3)
Railroads	500	Passenger Stations (3)
	24,000	Passenger Rail Miles (3)
	200,000	Freight Rail Miles (3)

Sources: References 3 and 4 as noted

**TABLE 2**  
**PUBLIC WORKS CONSTRUCTION, OPERATIONS, AND**  
**MAINTENANCE IN TRANSPORTATION ANNUAL SPENDING**  
**(IN BILLIONS OF 1984 DOLLARS)**

LIFELINE	1960	1970	1980	1984
Highways	36.3	48.1	41.6	40.1
Airports	2.7	5.4	6.2	6.6
Mass Transit	2.4	4.4	10.6	13.3
Totals	41.4	57.9	58.4	60.0

Source: Reference 4

RECOMMENDATIONS FOR LIFELINE SEISMIC STANDARDS

**TABLE 3**  
**TRANSPORTATION SYSTEMS AND THEIR COMPONENTS**

TRANSPORTATION SYSTEM	COMPONENTS
Highways	Pavements, bridges, tunnels, embankments, slopes, avalanche and rock shelters, retaining walls, signal and lighting systems, maintenance facilities
Railroads	Track, bridges, tunnels, embankments, slopes, avalanche and rock shelters, retaining walls, stations, platforms, signal and control systems, freight handling facilities, rolling stock, maintenance facilities
Mass Transit	Elevated track and station structures, bridges, tunnels, subway stations, platforms, rail power, overhead catenary, signal and control systems, rolling stock, maintenance facilities
Ports and Waterways	Wharves, quays, walls, bulkheads, cofferdams, sea bunds, breakwaters, dry docks (with vessel), freight handling facilities, roll-on and roll-off structures, bridges, pavements, aprons, canal locks, terminals, buildings, fuel storage facilities
Air Transportation Facilities	Runways, control towers, bridges, embankments, air traffic control equipment, terminals, buildings, passenger loading/unloading bridges, shuttle/mobile lounges, fuel storage facilities, freight handling equipment, signal and control systems, maintenance facilities, air route traffic control centers and associated telecommunication facilities

Note that, although listed separately in Table 3, railroads and mass transit systems are considered together in subsequent sections.

**TABLE 4**  
**OVERALL SCHEDULE FOR DEVELOPMENT OF SEISMIC STANDARDS FOR NEW AND EXISTING TRANSPORTATION FACILITIES**

PHASE	YEAR								
	1	2	3	4	5	6	7	8	
I Criteria Development Research Program	▨								
II Standards Development (System and Component Standards, Equipment and Materials Provisions)			▨						
III Evaluation, Review and Education			●		●	▨			

**TABLE 5**  
**BUDGET SUMMARY FOR SEISMIC STANDARDS FOR NEW AND EXISTING TRANSPORTATION FACILITIES**

	NEW CONSTRUCTION	EXISTING CONSTRUCTION	TOTALS
Standards Development	4,960,000	3,940,000	8,900,000
Research Program	7,760,000	14,650,000	22,410,000
Totals	12,720,000	18,590,000	31,310,000

RECOMMENDATIONS FOR LIFELINE SEISMIC STANDARDS

TABLE 6  
 BUDGET SUMMARIES FOR STANDARDS FOR DESIGN OF  
 NEW TRANSPORTATION FACILITIES

TASK	SYSTEM										TOTALS
	HIGHWAYS		RAILROADS		PORTS/ WATERWAYS		AIR TRANSPORTATION FACILITIES				
	Standards	Research	Standards	Research	Standards	Research	Standards	Research	Standards	Research	
1. Philosophy	80,000		80,000		80,000		80,000		80,000		\$320,000
2. System Design	150,000	500,000	150,000	400,000	100,000	500,000	150,000	500,000	150,000	500,000	2,400,000
3. Component Design	360,000	1,550,000	480,000	2,000,000	360,000	1,450,000	240,000	860,000	240,000	860,000	7,300,000
4. Equipment and Materials	150,000		150,000		150,000		150,000		150,000		600,000
5. Evaluation and Education	550,000		650,000		450,000		450,000		450,000		2,100,000
Totals for Standards	1,290,000		1,510,000		1,140,000		1,020,000		1,020,000		4,960,000
Totals for Research		2,050,000		2,400,000		1,950,000		1,360,000		1,360,000	7,760,000
Grand Total	\$3,340,000		\$3,910,000		\$3,090,000		\$2,380,000				\$12,720,000



TRANSPORTATION LIFELINES

TABLE 7

SCHEDULE AND BUDGET SUMMARY STANDARDS FOR  
DESIGN OF NEW TRANSPORTATION FACILITIES  
(\$ THOUSANDS)

TASKS ALL SYSTEMS	YEAR								TOTALS
	1	2	3	4	5	6	7	8	
<b>1. PHILOSOPHY OF SEISMIC DESIGN</b> • Develop Philosophy • Review <b>Budget Subtotal (\$000's)</b>	240	80							320
<b>2. SYSTEM STANDARDS</b> <b>Research Tasks</b> • Vulnerability Assessment <b>Standards Development</b> • Develop Standards and Commentaries • Review <b>Budget Subtotal (\$000's)</b>	950	950 360	140						2,400
<b>3. COMPONENT STANDARDS</b> <b>Highway Systems</b> • Research Tasks • Standards Development <b>Railroad Systems</b> • Research Tasks • Standards Development <b>Ports and Waterways</b> • Research Tasks • Standards Development <b>Air Transportation Facilities</b> • Research Tasks • Standards Development <b>Budget Subtotal (\$000's)</b>	500 400 450 260	450 600 450 350	300 120 500 180 400 120 200	300 120 500 180 150 120 120	120 120 120 120				7,300
<b>4. EQUIPMENT AND MATERIALS</b> • Develop Provisions • Review <b>Budget Subtotal (000's)</b>				400	200				600
<b>5. EVALUATION AND EDUCATION</b> • Field Trials • Develop Instructional Material • Conduct Pilot Workshops <b>Budget Subtotal (\$000's)</b>						500	500 650	450	2,100
<b>TOTAL (\$000's)</b>	2,850	3,240	1,960	1,890	680	500	1,150	450	12,720

RECOMMENDATIONS FOR LIFELINE SEISMIC STANDARDS

TABLE 8  
 PRIORITIES FOR THE DEVELOPMENT OF STANDARDS  
 FOR NEW CONSTRUCTION

TASK*	PRIORITY†
1. Philosophy Of Seismic Design	H
2. System Design - Performance Standard	H
3. Component Design - Prescriptive Standards	
Bridges	H
Pavements	L
Slopes And Embankments	M
Retaining Walls	H
Tunnels	H
Buildings	Δ
Special Structures: Rock And Avalanche Shelters	L
Platforms And Signs	L
Locks	M
Cranes	H
Control Towers And Centers	H
Airport Runways	M
Terminal Buildings	Δ
4. Equipment And Materials Provisions	H
5. Evaluation And Education	H

NOTES: • No attempt is made here to prioritize between the four separate transportation lifelines.

† H = High M = Medium L = Low

- Δ • For *general* structures, building standards exist (e.g., UBC), and the assigned priority in above table should be low. However, seismic provisions are not necessarily adopted by municipalities, state and federal agencies especially for public structures; in such cases adoption of UBC or similar should be a high priority.
- For *critical* structures (buildings whose contents are essential to response and recovery), codes such as UBC are inadequate since they are based on life-safety issues and not on serviceability requirements; in these cases new standards need to be developed, and the assigned priority in above table should be high.

**TABLE 9**  
**BUDGET SUMMARIES FOR STANDARDS FOR RETROFIT OF EXISTING**  
**TRANSPORTATION FACILITIES**

TASK	SYSTEM								TOTALS
	HIGHWAYS		RAILROADS		PORTS/ WATERWAYS		AIR TRANSPORTATION FACILITIES		
	Standards*	Research	Standards*	Research	Standards*	Research	Standards*	Research	
1. Philosophy	80,000		80,000		80,000		80,000		\$320,000
2. System Retrofit	150,000	500,000	150,000	400,000	100,000	500,000	100,000	500,000	2,400,000
3. Component Retrofit	180,000	3,250,000	240,000	4,250,000	180,000	3,250,000	120,000	2,000,000	13,470,000
4. Equipment and Materials	75,000		75,000		75,000		75,000		300,000
5. Evaluation and Education	550,000		650,000		450,000		450,000		2,100,000
Totals for Standards	1,035,000		1,195,000		825,000		825,000		3,940,000
Totals for Research		3,750,000		4,650,000		3,750,000		2,500,000	14,650,000
Grand Total		\$4,785,000		\$5,845,000		\$4,635,000		\$3,325,000	\$18,590,000

\* Assumes cost sharing with standards development for new construction

RECOMMENDATIONS FOR LIFELINE SEISMIC STANDARDS

TABLE 10  
 SCHEDULE AND BUDGET SUMMARY STANDARDS  
 FOR RETROFIT OF EXISTING TRANSPORTATION FACILITIES  
 (\$ THOUSANDS)

TASKS ALL SYSTEMS	YEAR								TOTALS	
	1	2	3	4	5	6	7	8		
<b>1. PHILOSOPHY OF SEISMIC RETROFIT</b> • Develop Philosophy • Review <b>Budget Subtotal (\$000's)</b>	240	80							320	
<b>2. SYSTEM STANDARDS</b> <b>Research Tasks</b> • Vulnerability Assessment <b>Standards Development</b> • Develop Standards and Commentaries • Review <b>Budget Subtotal (\$000's)</b>	950	950							2,400	
<b>3. COMPONENT STANDARDS</b> <b>Highway Systems</b> • Research Tasks • Standards Development <b>Railroad Systems</b> • Research Tasks • Standards Development <b>Ports and Waterways</b> • Research Tasks • Standards Development <b>Air Transportation Facilities</b> • Research Tasks • Standards Development <b>Budget Subtotal (\$000's)</b>	1050	1050	575	575	60	60			13,470	
<b>4. EQUIPMENT AND MATERIALS</b> • Develop Provisions • Review <b>Budget Subtotal (000's)</b>				200	100				300	
<b>5. EVALUATION AND EDUCATION</b> • Field Trials • Develop Instructional Material • Conduct Pilot Workshops <b>Budget Subtotal (\$000's)</b>						500	500	650	450	2100
<b>TOTAL (\$000's)</b>	5,190	5,390	2,975	2,595	340	500	1,150	450	18,590	

TABLE 11  
 PRIORITIES FOR THE DEVELOPMENT  
 OF STANDARDS FOR RETROFITTING EXISTING CONSTRUCTION

TASK	HIGHWAYS	RAILWAYS	PORTS AND WATERWAYS	AIR TRANSPORTATION FACILITIES
1. Philosophy Of Seismic Retrofit	H	H	H	H
2. System Retrofit Standards	H	H	H	H
3. Component Retrofit Standards				
Bridges	H	H	H	H
Pavements	M	M	L	L
Slopes And Embankments	H	H	M	L
Retaining Walls	H	H	M	L
Tunnels	H	H	L	L
Buildings	L	M	H	M
Special Structures: Rock And Avalanche Shelters	L	L	-	-
Platforms And Signs	L	L	L	L
Locks	-	-	M	-
Cranes	-	M	H	-
Control Towers And Centers	H	H	H	H
Airport Runways	-	-	-	H
Terminal Buildings	-	-	H	H
4. Equipment And Materials Provisions	H	H	H	H
5. Evaluation And Education	H	H	H	H

NOTES: H = High M = Medium L = Low

RECOMMENDATIONS FOR LIFELINE SEISMIC STANDARDS

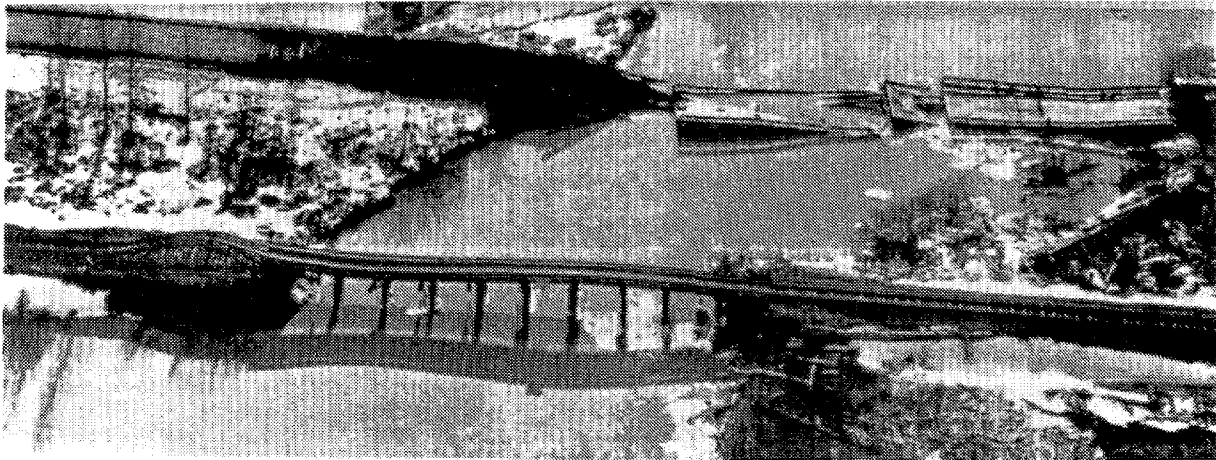


Figure 1. Collapsed bridge on the Seward Highway. Also track damage on approaches to adjacent railroad bridge. Prince William Sound earthquake, March 27, 1964.



Figure 2. Collapsed bridges on the Golden State Freeway at Interchange 5/14. San Fernando earthquake, February 9, 1971.

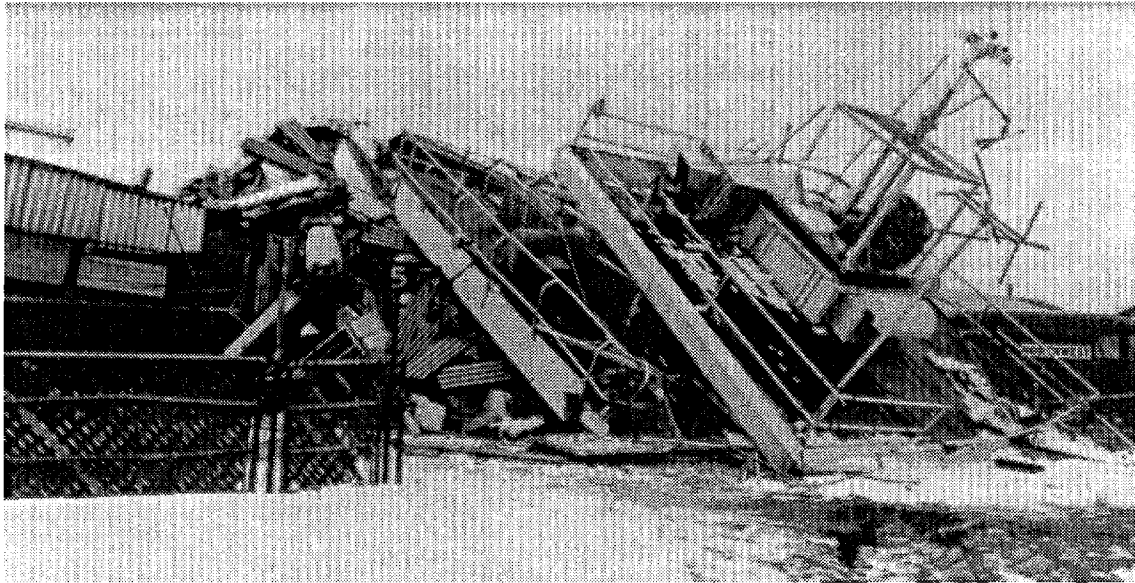


Figure 3. Collapsed control tower at Anchorage International Airport. Prince William Sound earthquake, March 27, 1964.

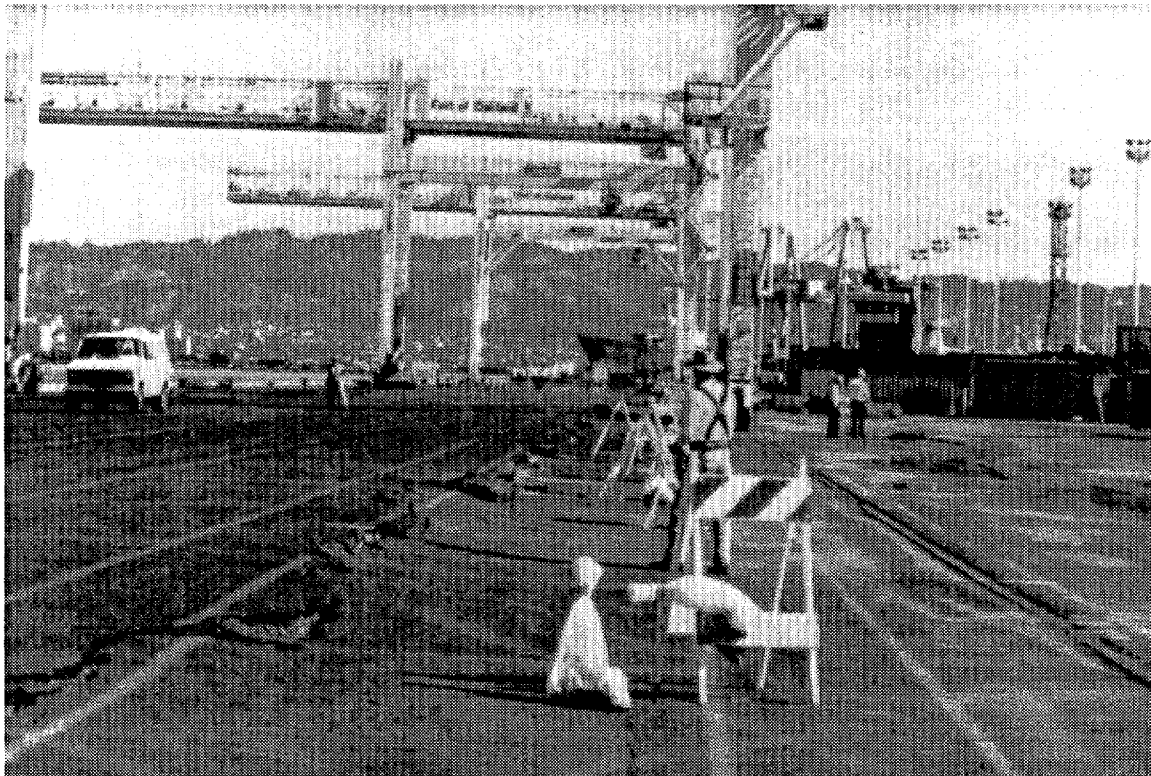


Figure 4. Failure of fill supporting inboard crane rail at Port of Oakland. Loma Prieta earthquake, October 17, 1989.

RECOMMENDATIONS FOR LIFELINE SEISMIC STANDARDS

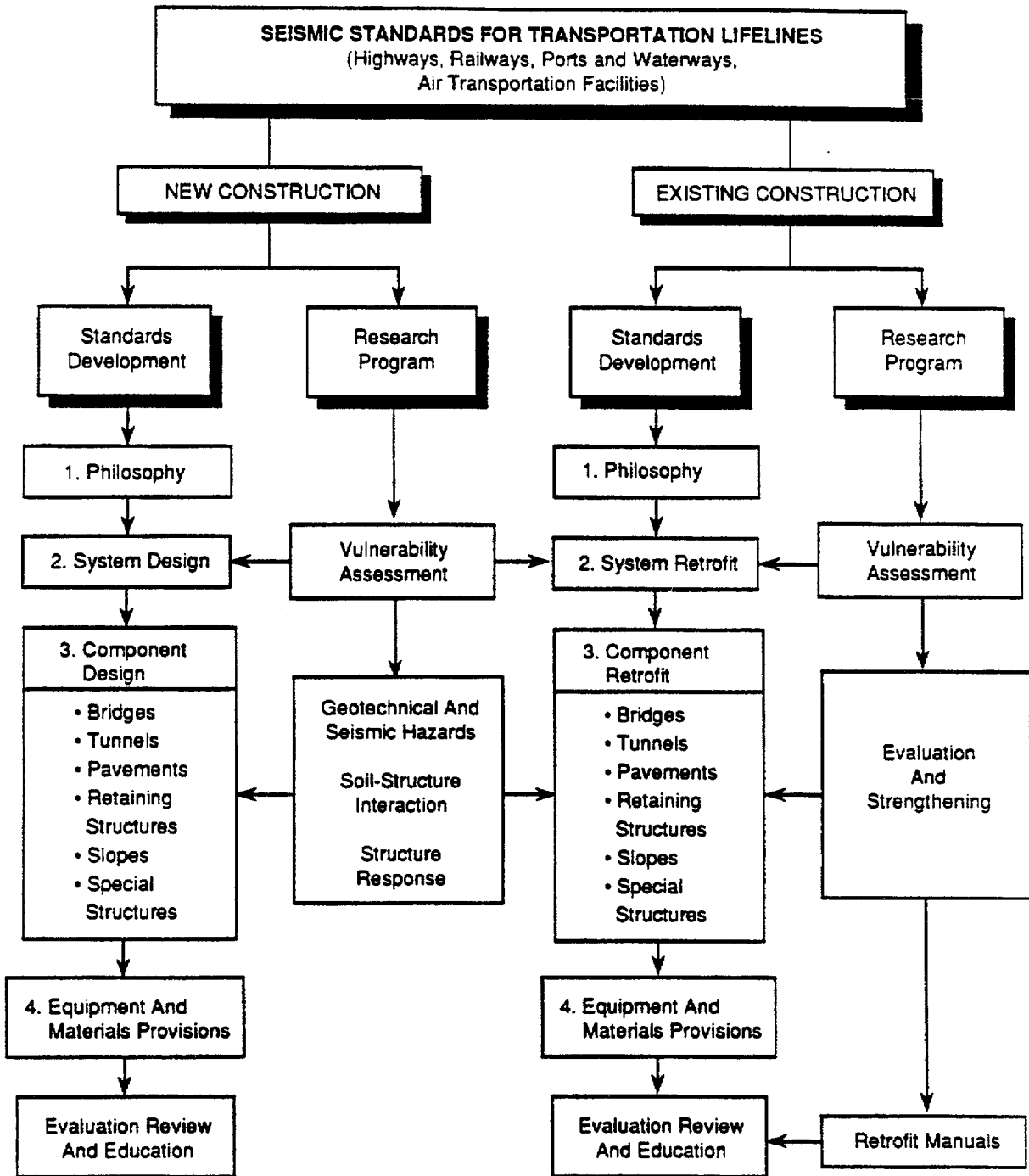


Figure 5. Flowchart for the development of seismic standards for transportation lifelines.



**V-5. APPENDIX**

The appendix consists of tables that present budget, schedule, and personnel data for the development of seismic standards for the construction of the following new transportation systems: highways, railways, ports and waterways, and air transportation, as follows:

- Table A1--Budget and Personnel for Highway Standards for New Construction
- Table A2--Schedule and Budget for Highway Standards for New Construction
- Table A3--Budget and Personnel for Railway Standards for New Construction
- Table A4--Schedule and Budget for Railway Standards for New Construction
- Table A5--Budget and Personnel for Port/Waterway Standards for New Construction
- Table A6--Schedule and Budget for Port/Waterway Standards for New Construction
- Table A7--Budget and Personnel for Air Transportation Standards for New Construction
- Table A8--Schedule and Budget for Air Transportation Standards for New Construction

RECOMMENDATIONS FOR LIFELINE SEISMIC STANDARDS

TABLE A1  
BUDGET AND PERSONNEL FOR HIGHWAY STANDARDS  
FOR NEW CONSTRUCTION

TASKS	EFFORT	BUDGET*	AGENCIES
<b>1. PHILOSOPHY OF SEISMIC DESIGN</b> <ul style="list-style-type: none"> <li>• Assemble consultant/review panel</li> <li>• Conduct workshop (part 1)</li> <li>• Prepare statement</li> <li>• Review</li> </ul>	0.5 person yrs.	\$80,000	ATC ASCE/TCLÉE AASHTO/NCHRP
<b>2. SYSTEM DESIGN</b> <b>Research Task</b> <ul style="list-style-type: none"> <li>• System vulnerability assessment</li> </ul> <b>Standards Development</b> <ul style="list-style-type: none"> <li>• Workshop (part 2)</li> <li>• Develop performance standard and commentary</li> <li>• Review</li> </ul>	(24 months)†	500,000	UNIVERSITIES CONSULTANTS
<b>3. COMPONENT DESIGN</b> <b>Research Tasks</b> <ul style="list-style-type: none"> <li>• Seismic hazard, site response, liquefaction, large ground deformation, coherence</li> <li>• Soil-structure interaction, piled foundations, retaining structures, underground structures</li> <li>• Structural response, large-scale experiments, long-span bridges, joints, connections, intersections</li> </ul> <b>Standards Development</b> <ul style="list-style-type: none"> <li>• Evaluate existing standards</li> <li>• Develop draft standards and commentaries for bridges, pavements, slopes and embankments, tunnels, retaining walls, buildings (as needed), special structures</li> <li>• Review</li> </ul>	(24 months)	250,000	UNIVERSITIES CONSULTANTS NIST
	(48 months)	500,000	
	(48 months)	800,000	
	3.0 person yrs.	360,000	NCEER NIST AASHTO/NCHRP UNIVERSITIES
<b>4. EQUIPMENT AND MATERIALS</b> <ul style="list-style-type: none"> <li>• Evaluate existing provisions</li> <li>• Develop revisions as appropriate</li> <li>• Review</li> </ul>	1.5 person yrs.	150,000	NIST AASHTO/NCHRP
<b>5. EVALUATION AND EDUCATION</b> <ul style="list-style-type: none"> <li>• Field trials</li> <li>• Evaluation</li> <li>• Prepare instructional material</li> <li>• Conduct pilot workshops</li> </ul>	5.5 person yrs.	550,000	NCEER ASCE/TCLÉE FHWA DOTS UNIVERSITIES
<b>TOTAL</b>		<b>\$3,340,000</b>	

\* Assumes cost-sharing between transportation lifelines

† Figures in parentheses represent project duration, not effort

**TABLE A2**  
**SCHEDULE AND BUDGET FOR HIGHWAY STANDARDS**  
**FOR NEW CONSTRUCTION**  
**(\$ THOUSANDS)**

TASKS	YEAR								TOTALS
	1	2	3	4	5	6	7	8	
<b>1. PHILOSOPHY OF SEISMIC DESIGN</b>									
• Develop philosophy	60								60
• Review		20							20
<b>Budget Subtotal (\$000's)</b>									<b>80</b>
<b>2. SYSTEM STANDARDS</b>									
<b>Research Tasks</b>									
• Vulnerability assessment	250	250							500
<b>Standards Development</b>									
• Develop standards and commentaries		100							100
• Review			50						50
<b>Budget Subtotal (\$000's)</b>									<b>650</b>
<b>3. COMPONENT STANDARDS</b>									
<b>Research Tasks</b>									
• Seismic hazard and ground motion	150	100							250
• Soil structure interaction	150	150	100	100					500
• Structural response	200	200	200	200					800
<b>Standards Development</b>									
• Develop standards and commentaries			120	120					240
• Review					120				120
<b>Budget Subtotal (\$000's)</b>									<b>1,910</b>
<b>4. EQUIPMENT AND MATERIALS</b>									
• Develop provisions				100					100
• Review					50				50
<b>Budget Subtotal (000's)</b>									<b>150</b>
<b>5. EVALUATION AND EDUCATION</b>									
• Field trials and evaluation						150	150		300
• Develop instructional material							150		150
• Conduct pilot workshops								100	100
<b>Budget Subtotal (\$000's)</b>									<b>550</b>
<b>TOTALS</b>	<b>810</b>	<b>820</b>	<b>470</b>	<b>520</b>	<b>170</b>	<b>150</b>	<b>300</b>	<b>100</b>	<b>3,340</b>

RECOMMENDATIONS FOR LIFELINE SEISMIC STANDARDS

TABLE A3

BUDGET AND PERSONNEL FOR RAILWAY STANDARDS FOR NEW CONSTRUCTION

TASKS	EFFORT	BUDGET*	AGENCIES
<b>1. PHILOSOPHY OF SEISMIC DESIGN</b> <ul style="list-style-type: none"> <li>• Assemble consultant/review panel</li> <li>• Conduct workshop (part 1)</li> <li>• Prepare statement</li> <li>• Review</li> </ul>	0.5 person yrs	\$80,000	ATC ASCE/TCLEE
<b>2. SYSTEM DESIGN</b> <p><b>Research Task</b></p> <ul style="list-style-type: none"> <li>• System vulnerability assessment</li> </ul> <p><b>Standards Development</b></p> <ul style="list-style-type: none"> <li>• Workshop (part 2)</li> <li>• Develop performance standard and commentary</li> <li>• Review</li> </ul>	(24 months)†	400,000	UNIVERSITIES CONSULTANTS
	1.5 person yrs	150,000	ATC ASCE/TCLEE NIST FRA
<b>3. COMPONENT DESIGN</b> <p><b>Research Tasks</b></p> <ul style="list-style-type: none"> <li>• Seismic hazard, site response, liquefaction, large ground deformation, coherence</li> <li>• Soil-structure interaction, piled foundations, retaining structures, underground structures</li> <li>• Structural response, large-scale experiments, joints, connections, intersections</li> </ul> <p><b>Standards Development</b></p> <ul style="list-style-type: none"> <li>• Evaluate existing standards</li> <li>• Develop draft standards and commentaries for bridges, track, slopes and embankments, tunnels, retaining walls, buildings (as needed), special structures</li> <li>• Review</li> </ul>	(24 months)	250,000	UNIVERSITIES CONSULTANTS NIST
	(48 months)	850,000	
	(36 months)	900,000	
	4.5 person yrs	480,000	NCEER NIST UNIVERSITIES
<b>4. EQUIPMENT AND MATERIALS</b> (includes electric power and fuel storage facilities) <ul style="list-style-type: none"> <li>• Evaluate existing provisions</li> <li>• Develop revisions as appropriate</li> <li>• Review</li> </ul>	1.5 person yrs	150,000	NIST
<b>5. EVALUATION AND EDUCATION</b> <ul style="list-style-type: none"> <li>• Field trials</li> <li>• Evaluation</li> <li>• Prepare instructional material</li> <li>• Conduct pilot workshops</li> </ul>	6.5 person yrs	650,000	NCEER ASCE/TCLEE AREA ATC UNIVERSITIES
<b>TOTAL</b>		<b>\$3,910,000</b>	

\* Assumes cost-sharing between transportation lifelines

† Figures in parentheses represent project duration, not effort

**TABLE A4**  
**SCHEDULE AND BUDGET FOR RAILROAD STANDARDS**  
**FOR NEW CONSTRUCTION**  
**(\$ THOUSANDS)**

TASKS	YEAR								TOTALS
	1	2	3	4	5	6	7	8	
<b>1. PHILOSOPHY OF SEISMIC DESIGN</b>									
• Develop philosophy	60								60
• Review		20							20
<b>Budget Subtotal (\$000's)</b>									<b>80</b>
<b>2. SYSTEM STANDARDS</b>									
<b>Research Tasks</b>									
• Vulnerability assessment	200	200							400
<b>Standards Development</b>									
• Develop standards and commentaries		100							100
• Review			50						50
<b>Budget Subtotal (\$000's)</b>									<b>550</b>
<b>3. COMPONENT STANDARDS</b>									
<b>Research Tasks</b>									
• Seismic hazard and ground motion	150	100							250
• Soil structure interaction	250	200	200	200					850
• Structural response		300	300	300					900
<b>Standards Development</b>									
• Develop standards and commentaries			180	180					360
• Review					120				120
<b>Budget Subtotal (\$000's)</b>									<b>2,480</b>
<b>4. EQUIPMENT AND MATERIALS</b>									
• Develop provisions				100					100
• Review					50				50
<b>Budget Subtotal (000's)</b>									<b>150</b>
<b>5. EVALUATION AND EDUCATION</b>									
• Field trials and evaluation						150	150		300
• Develop instructional material							200		200
• Conduct pilot workshops								150	150
<b>Budget Subtotal (\$000's)</b>									<b>650</b>
<b>TOTALS</b>	<b>660</b>	<b>920</b>	<b>730</b>	<b>780</b>	<b>170</b>	<b>150</b>	<b>350</b>	<b>150</b>	<b>3,910</b>

RECOMMENDATIONS FOR LIFELINE SEISMIC STANDARDS

TABLE A5

BUDGET AND PERSONNEL FOR PORT/WATERWAY STANDARDS FOR NEW CONSTRUCTION

TASKS	EFFORT	BUDGET*	AGENCIES
<b>1. PHILOSOPHY OF SEISMIC DESIGN</b> <ul style="list-style-type: none"> <li>• Assemble consultant/review panel</li> <li>• Conduct workshop (part 1)</li> <li>• Prepare statement</li> <li>• Review</li> </ul>	0.5 person yrs	\$80,000	ATC ASCE/TCLEE
<b>2. SYSTEM DESIGN</b> <p><b>Research Task</b></p> <ul style="list-style-type: none"> <li>• System vulnerability assessment</li> </ul> <p><b>Standards Development</b></p> <ul style="list-style-type: none"> <li>• Workshop (part 2)</li> <li>• Develop performance standard and commentary</li> <li>• Review</li> </ul>	(24 months)†	500,000	UNIVERSITIES CONSULTANTS
	1.0 person yrs	150,000	ATC ASCE/TCLEE NIST
<b>3. COMPONENT DESIGN</b> <p><b>Research Tasks</b></p> <ul style="list-style-type: none"> <li>• Seismic hazard, site response, liquefaction, large ground deformation, coherence</li> <li>• Soil-structure interaction, piled foundations, retaining structures, underground structures</li> <li>• Structural response, large-scale experiments, joints, connections</li> </ul> <p><b>Standards Development</b></p> <ul style="list-style-type: none"> <li>• Evaluate existing standards</li> <li>• Develop draft standards and commentaries for wharves, pavements, slopes and embankments, retaining walls, buildings (as needed), special structures (including container cranes, roll-on-roll-off structures)</li> <li>• Review</li> </ul>	(48 months)	350,000	CONSULTANTS UNIVERSITIES NIST
	(48 months)	700,000	
	(36 months)	400,000	
	3.0 person years	360,000	NCEER NIST UNIVERSITIES
<b>4. EQUIPMENT AND MATERIALS</b> (includes electric power and fuel storage facilities) <ul style="list-style-type: none"> <li>• Evaluate existing provisions</li> <li>• Develop revisions as appropriate</li> <li>• Review</li> </ul>	1.5 person yrs	150,000	NIST
<b>5. EVALUATION AND EDUCATION</b> <ul style="list-style-type: none"> <li>• Field trials</li> <li>• Evaluation</li> <li>• Prepare instructional material</li> <li>• Conduct pilot workshops</li> </ul>	4.5 person yrs	450,000	NCEER ASCE/TCLEE AREA ATC UNIVERSITIES
<b>TOTAL</b>		<b>\$3,090,000</b>	

\* Assumes cost-sharing between transportation lifelines

† Figures in parentheses represent project duration, not effort

TABLE A5

SCHEDULE AND BUDGET FOR PORT/WATERWAY  
STANDARDS FOR NEW CONSTRUCTION  
(\$ THOUSANDS)

TASKS	YEAR								TOTALS
	1	2	3	4	5	6	7	8	
<b>1. PHILOSOPHY OF SEISMIC DESIGN</b> <ul style="list-style-type: none"> <li>• Develop philosophy</li> <li>• Review</li> </ul> <b>Budget Subtotal (\$000's)</b>	60	20							80
<b>2. SYSTEM STANDARDS</b> <b>Research Tasks</b> <ul style="list-style-type: none"> <li>• Vulnerability assessment</li> </ul> <b>Standards Development</b> <ul style="list-style-type: none"> <li>• Develop standards and commentaries</li> <li>• Review</li> </ul> <b>Budget Subtotal (\$000's)</b>	250	250							500
<b>3. COMPONENT STANDARDS</b> <b>Research Tasks</b> <ul style="list-style-type: none"> <li>• Seismic hazard and ground motion</li> <li>• Soil structure interaction</li> <li>• Structural response</li> </ul> <b>Standards Development</b> <ul style="list-style-type: none"> <li>• Develop standards and commentaries</li> <li>• Review</li> </ul> <b>Budget Subtotal (\$000's)</b>	100 200 150	100 200 150	100 200 100	50 100					350 700 400
<ul style="list-style-type: none"> <li>• Develop standards and commentaries</li> <li>• Review</li> </ul> <b>Budget Subtotal (\$000's)</b>			120	120	120				240 120 1,810
<b>4. EQUIPMENT AND MATERIALS</b> <ul style="list-style-type: none"> <li>• Develop provisions</li> <li>• Review</li> </ul> <b>Budget Subtotal (\$000's)</b>				100	50				100 50 150
<b>5. EVALUATION AND EDUCATION</b> <ul style="list-style-type: none"> <li>• Field trials and evaluation</li> <li>• Develop instructional material</li> <li>• Conduct pilot workshops</li> </ul> <b>Budget Subtotal (\$000's)</b>						100	100	150	200 150 100 450
<b>TOTALS</b>	760	800	540	370	170	100	250	100	3,090

RECOMMENDATIONS FOR LIFELINE SEISMIC STANDARDS

TABLE A7

BUDGET AND PERSONNEL FOR AIR TRANSPORTATION STANDARDS FOR NEW CONSTRUCTION

TASKS	EFFORT	BUDGET*	AGENCIES
<b>1. PHILOSOPHY OF SEISMIC DESIGN</b> <ul style="list-style-type: none"> <li>• Assemble consultant/review panel</li> <li>• Conduct workshop (part 1)</li> <li>• Prepare statement</li> <li>• Review</li> </ul>	0.5 person yrs	\$80,000	ATC ASCE/TCLEE
<b>2. SYSTEM DESIGN</b> <p><b>Research Task</b></p> <ul style="list-style-type: none"> <li>• System vulnerability assessment</li> </ul> <p><b>Standards Development</b></p> <ul style="list-style-type: none"> <li>• Workshop (part 2)</li> <li>• Develop performance standard and commentary</li> <li>• Review</li> </ul>	(24 months)†	500,000	UNIVERSITIES ATC
<p><b>Standards Development</b></p> <ul style="list-style-type: none"> <li>• Develop performance standard and commentary</li> <li>• Review</li> </ul>	1.0 person yrs	100,000	ASCE/TCLEE NIST
<b>3. COMPONENT DESIGN</b> <p><b>Research Tasks</b></p> <ul style="list-style-type: none"> <li>• Seismic hazard, site response, liquefaction, large ground deformation, coherence</li> <li>• Structural response, joints, connections</li> </ul> <p><b>Standards Development</b></p> <ul style="list-style-type: none"> <li>• Evaluate existing standards</li> <li>• Develop draft standards and commentaries for pavements, control towers, buildings, special structures (including passenger/freight loading/unloading facilities)</li> <li>• Review</li> </ul>	(24 months)	300,000	CONSULTANTS UNIVERSITIES NIST
	(36 months)	560,000	
	2.0 person yrs	240,000	NCEER NIST UNIVERSITIES
<b>4. EQUIPMENT AND MATERIALS</b> (includes electric power and fuel storage facilities) <ul style="list-style-type: none"> <li>• Evaluate existing provisions</li> <li>• Develop revisions as appropriate</li> <li>• Review</li> </ul>	1.5 person yrs	150,000	NIST
<b>5. EVALUATION AND EDUCATION</b> <ul style="list-style-type: none"> <li>• Field trials</li> <li>• Evaluation</li> <li>• Prepare instructional material</li> <li>• Conduct pilot workshops</li> </ul>	4.5 person yrs	450,000	ATC NCEER ASCE/TCLEE FAA
<b>TOTAL</b>		<b>\$2,380,000</b>	

\* Assumes cost-sharing between transportation lifelines

† Figures in parentheses represent project duration, not effort



TRANSPORTATION LIFELINES

TABLE A8  
 SCHEDULE AND BUDGET FOR  
 AIR TRANSPORTATION STANDARDS FOR NEW CONSTRUCTION  
 (\$ THOUSANDS)

TASKS	YEAR								TOTALS
	1	2	3	4	5	6	7	8	
<b>1. PHILOSOPHY OF SEISMIC DESIGN</b> • Develop philosophy • Review Budget Subtotal (\$000's)	60	20							60 20 80
<b>2. SYSTEM STANDARDS</b> Research Tasks • Vulnerability assessment Standards Development • Develop standards and commentaries • Review Budget Subtotal (\$000's)	250	250 80	20						500 80 20 600
<b>3. COMPONENT STANDARDS</b> Research Tasks • Seismic hazard and ground motion • Structural response Standards Development • Develop standards and commentaries • Review Budget Subtotal (\$000's)	150 160	150 200	200	120	120				300 560 120 120 1,100
<b>4. EQUIPMENT AND MATERIALS</b> Standards Development • Develop provisions • Review Budget Subtotal (000's)				100	50				100 50 150
<b>5. EVALUATION AND EDUCATION</b> • Field trials and evaluation • Develop instructional material • Conduct pilot workshops Budget Subtotal (\$000's)						100	100 150	100	200 150 100 450
<b>TOTALS</b>	620	700	220	220	170	100	250	100	2,380



## CHAPTER VI: WATER AND SEWER LIFELINES

*DONALD BALLANTYNE*

---

### VI-1. INTRODUCTION

Water and sewer systems are damaged by earthquakes. The purpose of this chapter is to develop a plan for the development of design and construction standards for water and sewer facilities, which will reduce the consequences of an earthquake.

It is not the intent of the National Institute of Standards and Technology (NIST) to develop standards directly, but to facilitate standards development by existing standards organizations with the support of the technical community--not duplicating relevant existing standards but identifying and incorporating them by reference into the proposed standards documents.

#### VI-1.1 Elements Of A Lifeline Standard: Water And Sewer Facilities

A lifeline earthquake code or standard for water and sewer facilities should consider the five elements listed below.

1. Policy Statement--Defining the system performance requirements and operational expectations during and following an earthquake
2. System Evaluation Standards--Defining how the system performance requirements and operational expectations during and following the earthquake can be evaluated in comparison with the policy statement and indicating deficiencies to be corrected
3. Component Design/Evaluation Standards--Defining the detailed engineering design/evaluation of new, replacement, or existing components, which would also serve as input to the system evaluation
4. Equipment and Material Standards
5. System Emergency Operation Planning, Response, and Recovery

Public Law 101-614 is explicit about addressing design and construction methods for new and existing structures, as included in Elements 1, 3, and 4, above. Lifeline systems are differentiated from building structures because of the system component interaction, as addressed in Element 2. A detailed discussion on including Element 2 is included. Element 5, System Emergency Operation Planning, Response, and Recovery, is critical to minimize system disruption following an earthquake and to provide a road map to system restoration. Therefore Element 5 is included.

#### VI-1.2 Water And Sewer System Components

Water systems are made up of individual components that work together to provide water for fire

## RECOMMENDATIONS FOR LIFELINE SEISMIC STANDARDS

protection, drinking, sanitary needs, industrial use, and irrigation. Similarly, sewer systems are comprised of components that work together to collect, transmit, treat, and dispose of sewage. Each component may include equipment and materials.

Water and sewer system component functions include the following:

- Potable Water Systems
  - Supply sources
  - Transmission
  - Treatment
  - Pumping
  - Storage
  - Distribution
  - Pressure regulation
  - System control
  - Operation, maintenance, and storage facilities
- Sewer Systems
  - Collection
  - Pumping
  - Transmission
  - Treatment
  - Disposal
  - System Control
  - Operation, maintenance, and storage facilities

In general, these components may include:

- Dams and diversion structures
- Conveyance (pipelines, tunnels, aqueducts, canals) (see Figure 1 showing a typical pipeline earthquake failure repair)
- Storage (buried, at grade, and elevated)
- Wells
- Equipment and plant piping (mechanical, electrical, and instrumentation)
- Building and other structures
- Nonstructural components
- Electric power plants and substations

Fire-suppression systems using nonpotable water may have many of the same components as a water system, and are subject to earthquake damage.

The intent here is only to relate building structures to existing building codes and standards, and identify any required modification to design criteria for lifeline systems. Electric power plants and substations will be included in the electrical power systems component of this Federal Emergency Management Agency (FEMA)/NIST program. All other components listed will be discussed herein.

### **VI-1.3 Historic Performance Of Water And Sewer Systems In Earthquakes**

Providing water for fire suppression is the most critical requirement for water-system function following an earthquake. The City of San Francisco was largely destroyed by fire following the 1906 San Francisco earthquake because the water system was inoperable. Following the 1906 earthquake, San Francisco constructed an auxiliary water system specifically to be earthquake resistant to provide water for fire suppression for the next earthquake.

Neither the municipal nor the auxiliary water systems were functional in areas in San Francisco requiring water for fire suppression following the 1989 Loma Prieta earthquake. The City was extremely fortunate that there was no wind the evening of the earthquake to spread the fires that resulted. In both the 1906 and 1989 earthquakes the predominant factor impacting system disfunction was pipeline failure in liquefiable soil areas. Following the Loma Prieta earthquake, system operational hardware also failed.

Other area water systems were significantly impacted in the Loma Prieta earthquake. Reservoirs in higher pressure zones in the Santa Cruz water system quickly drained because of extensive pipeline damage in soft-soil areas along the San Lorenzo River. This resulted in not being able to provide water service to the two local hospitals. The power outage prevented the pumping of raw water to the treatment plant serving the area. The area was extremely lucky that there was no wind that evening to spread fire. Water supply to some parts of the City was not restored for up to one week.

Five water tanks collapsed in the San Lorenzo water district immediately north of Santa Cruz. One one-million gallon tank drained in Scotts Valley, just east of Santa Cruz, when it rocked on its foundation, snapping the connecting piping. The Redwood Estates water system, located in the Santa Cruz Mountains near the epicenter, was not restored for five months following the earthquake.

Water-treatment facilities were damaged in the Loma Prieta earthquake. Process equipment and baffles were broken up by sloshing water in treatment plants in the Santa Clara Valley and San Jose, putting them out of operation for up to one month. The earthquake occurred after the peak demand period for water, which occurs during the summer months. As a result, water purveyors could keep up with the demand. A mid-summer earthquake would have had a greater impact on meeting water demands.

Sludge digesters at sewage treatment plants were damaged as far away as 160 kilometers in Sacramento and Oakland. Methane gas could have been released if damage had been more severe, as would be expected in a longer-duration event.

In Washington State, the 1949 7.1-magnitude earthquake broke water lines, leaving the State's capital city of Olympia without water for one day. In 1965 a 6.5-magnitude earthquake broke water lines in Seattle, making one waterfront area vulnerable to fire without water. A recent study of the Seattle water system concluded that a significant portion of the system would be inoperable following a 6.5-magnitude event (Kennedy/Jenks/Chilton 1990b).

Because of lower recurrence intervals of earthquakes in areas such as Memphis, Tennessee, Charleston, South Carolina, and Boston, Massachusetts, we have not seen the impact of earthquakes on their water systems. We do know that they have had earthquakes exceeding the magnitude levels of those having significant impacts on water systems in other areas.

## RECOMMENDATIONS FOR LIFELINE SEISMIC STANDARDS

### VI-1.4 Current Status Of Standards

Information on the current status of standards in the lifeline industry is inventoried under the headings of the standards elements presented above.

- **Element 1**--Existing codes and commentaries establish seismic design policy for building structures. There is no nationally or regionally recognized document establishing a parallel policy for lifeline systems, required by Standards Element 1, Policy Statement. Also as part of the policy statement, levels of function should be defined for *moderate* and *major* earthquake events for each region. The criteria for those events should be given in terms of a return period.
- **Element 2**--Vulnerability assessment approaches have been developed for pipelines; storage; wells; mechanical, electrical, and instrumentation equipment; building structures; and nonstructural items. Postearthquake system-function models, which estimate water pressure and fire flow, are available in a preliminary form. Those system-function models incorporate component vulnerability assessment relationships. These system function models are the type that could be used for Standards Element 2, System Evaluation Standards.
- **Element 3**--Current design and construction practices have been documented by the American Society of Civil Engineers Technical Council on Lifeline Earthquake Engineering (ASCE TCLEE) primarily using a "guideline" approach. Guidelines and/or standards of practice have been specifically developed for water and sewer systems by the military, the Japan Society of Civil Engineers (JSCE), a municipal utility, and a consultant. These documents are in varying levels of detail, incorporate an inconsistent list of considerations, and do not have consensus among a wide range of users in the United States. Appropriate sections of these existing guidelines should form the basis of Standards Element 3, Component Design/Evaluation Standards.
- **Element 4**--Equipment and materials standards considering seismic design are available in some categories for tanks, pipe, plant piping, and electrical equipment. Current well design standards do not include seismic considerations. Buildings and equipment are addressed in existing building codes. Standards do exist for most materials and could have seismic provisions added, if necessary. These standards correspond to Standards Element 4, Equipment and Material Standards.
- **Element 5**--System Emergency Operation Planning, Response, and Recovery planning documents for water and sewer are available but with varying usefulness and availability.

### VI-1.5 Standards Development

A detailed discussion on incorporating Element 2 as part of the standard is presented later under subsection 3.3.

Elements 1 through 5 are described in detail herein establishing an inventory of standards that are required for each element in order to provide a comprehensive standard. Organizations recommended to take responsibility for standards development are identified, and priorities,

estimated budgets, and schedules are developed.

Research required to complete these standards development tasks is listed as part of each element description.

## VI-2. STATE OF THE ART

### VI-2.1 Introduction

This section discusses state-of-the-art references for vulnerability assessments and current design and construction practices. General documents discussing state-of-the-art strategies are discussed below.

In 1989, NIBS assembled an ad-hoc panel to develop strategies for implementing a comprehensive program to mitigate risk to lifelines from earthquakes (NIBS 1989). Recommendations for design criteria and standards development tasks resulting from this document, applicable to water and sewer systems, include:

1. Develop manuals for low-cost seismic hazard reduction
2. Establish pipeline deformation capability
3. Upgrade ASCE TCLEE *Advisory Notes on Lifeline Earthquake Engineering*
4. Develop a manual for small water and sewer lifelines
5. Develop a manual for treatment facilities
6. Develop a manual for tanks, basins, channels, and vaults
7. Prepare a booklet on seismic design for electrical and mechanical equipment
8. Develop test equipment for fragility levels

All but two recommendations from this document applicable to water and sewage systems were for manual development, not standards.

In 1987, FEMA assembled a group of experts to develop an action plan for seismic hazard abatement (FEMA 1987a). The action plan summarized water and sewer abatement needs presented in a separate volume (FEMA 1987b). The action plan to develop codes or standards for design, construction, and retrofitting of seismic-resistant water and sewer facilities included items 3, 4, and 5 from the list above as well as the following:

1. Develop a manual for water and sewer piping systems
2. Develop a manual for design of treatment, pumping, and well facilities

### VI-2.2 Vulnerability Assessments

The Earthquake Engineering Research Institute and others have published reconnaissance reports for specific earthquakes with anecdotal damage information. System vulnerability must include both system function and economic impact. The following referenced documents are comprehensive in nature, covering multiple earthquakes or a methodology that is applicable to generic systems.

- **Overall Approach**--A general overview of vulnerability assessments is presented by the NRC (1989). FEMA assembled a student manual entitled *Earthquake Hazard Mitigation for Utility Lifeline Systems (undated)*, which provides a more detailed approach focusing on utilities but no quantitative

## RECOMMENDATIONS FOR LIFELINE SEISMIC STANDARDS

assessment approach. Recently, the Applied Technology Council, ATC, assessed lifeline earthquake risk nationally (ATC-25, 1991). The ATC document develops lifeline vulnerability functions for generic components for all lifelines, and applies them to a national lifeline inventory. It also applies the methodology to a specific selected prototype water system.

- **Pipeline Vulnerability**--Pipeline vulnerability assessment considers various pipe material types, ground motion criteria, and ground deformation criteria. Early work was done by Katayama in 1979, who proposed damage (breaks/km) from both wave propagation and permanent ground deformation versus peak ground accelerations algorithms. That data, supplemented with information from more recent earthquakes, was applied to the Portland, Oregon, water and sewer system (Wang 1990). The ASCE TCLEE Water and Sewage Committee estimated losses to a hypothetical water system using a pipeline damage versus an intensity algorithm with Katayama's data as a basis (ASCE 1991a).

Eguchi (1983) proposed damage (breaks/km) versus Modified Mercalli Intensity (MMI) algorithms which were applied to the Seattle, Washington, water system, (Kennedy/Jenks/Chilton 1990b), and again to the Everett, Washington, water system (Kennedy/Jenks/Chilton 1991). Figure 2 shows the damage algorithm for cast iron pipe. The Seattle water-system study also presents a method for liquefaction microzonation mapping.

Barenberg (1988) proposes pipeline damage (repairs/km) for wave propagation versus peak ground velocity as well as pipe damage versus permanent ground displacement.

A study of liquefaction impact on utilities in San Francisco developed a methodology to estimate permanent ground deformation. Algorithms showing pipe damage rates in unit-break rate or percent-replacement versus net-permanent ground deformation for various types of water and sewer pipe were produced. Figure 3 depicts water main failures in the San Francisco Marina District resulting from the Loma Prieta earthquake (Harding Lawson Associates 1991). This pipeline failure data was used, as one resource, for developing the damage algorithms for the study. The same study also looks briefly at large open channel conduits constructed of brick or reinforced concrete.

There is a lack of credible seismic damage data on large diameter steel conduits although O'Rourke and Ayala (1991) suggest that the damage ratio for large diameter prestressed concrete cylinder pipe for wave propagation is similar to smaller diameter asbestos cement and cast-iron pipe.

All the references for pipeline vulnerability are appropriate for planning level studies only. They do not incorporate detailed site, or soils information.

- **Wells**--A planning-level document for the Metropolitan Water District of Southern California, MWD, estimated damage to well facilities for varying MMI and liquefaction probabilities for a given earthquake scenario (Dames & Moore 1991). There was damage to wells in the City of San Fernando during the 1971 San Fernando earthquake which was considered in the MWD report (NOAA/EERI 1973). There was significant damage to municipal water supply wells in the 1990



Philippine earthquake which corroborated the MWD study.

- **Mechanical, Electrical, And Instrumentation Equipment And Nonstructural Elements**--Engineering judgment during a walk-through, focusing on equipment anchorage, potential for differential movement, system geometry, empirical equipment fragility, coupled with simple calculations result in vulnerability assessment decisions. Anchored equipment has historically performed well. Spring vibration isolators have not performed well. Figure 4 shows a spring vibration isolator on an engine-generator set, damaged in an earthquake. Figure 5 shows a precariously mounted electrical power transformer serving an 80 million gallon per day sewage pump station, very vulnerable to earthquakes.

ATC assembled experts to quantify expected damage to, among other categories of facilities, equipment over a range of earthquake intensities (ATC-13 1985). ATC again assembled experts to review equipment and non-structural element design approaches (ATC-29, 1991).

- **At Grade And Elevated Steel Tank Structures**--There is not a good vulnerability assessment approach to assess existing tanks because there is a lack of empirical earthquake damage information. The American Water Works Association (AWWA) Standard for Welded Steel Tanks for Water Storage D100-84, which has had a seismic provision since 1979, is widely used in the water supply industry. The AWWA D100 design has not been subjected to a major earthquake.

There have been several preliminary approaches to tank damage algorithm development not considering the AWWA D100 standard. ASCE TCLEE (1991) proposed damage versus intensity algorithms for various tank ages, geometries, and types. ATC (1985) provided a tank damage algorithm which was later modified to make the curve more tank specific (Kennedy/Jenks/Chilton 1990a).

Several consulting firms have assessed existing elevated tanks and standpipes analytically but did not relate the results to the AWWA D100 standard (Cygn 1989; URS 1987).

The Uniform Building Code, UBC, (1988) defines seismic force levels for ground supported tanks. Depending on height to diameter ratios, the loads specified can be higher than those specified by AWWA D100-84.

Implementation of flexible pipe connection designs for tanks to accommodate differential movement has not been widely carried out. The Loma Prieta earthquake demonstrated the success of good flexible connection designs and the failure of rigid designs.

- **At And Below Grade Concrete Tanks, Treatment Facilities, And Vaults**--Damage to this category of structures is closely related to permanent ground deformation. Damage, other than from permanent ground deformation, has not been significant. ATC-13 (1985) proposes damage algorithms for similar types of massive concrete structures, but are not specific to tankage.

## RECOMMENDATIONS FOR LIFELINE SEISMIC STANDARDS

- **Tank Immersed And Floating Appurtenant Structures--** Kennedy/Jenks/Chilton (1990c) evaluates damage to water and wastewater treatment facilities subjected to the Loma Prieta earthquake and presents a design approach to mitigate damage to submerged elements. Figure 6 shows sloshing damage to a clarifier at the Rinconada Water Treatment Plant resulting from the Loma Prieta earthquake.  
  
There was significant damage to sewage sludge-digester floating covers in the Loma Prieta earthquake. There is currently no documented approach to estimate damage or a design technique to mitigate earthquake damage to these covers.
- **Building Structures--**ATC has assembled three documents for assessing the seismic vulnerability of existing buildings (ATC-14, 1987; ATC-21, 1988; ATC-22, 1989).
- **Postearthquake System Function Models--**Water distribution system network models, incorporating expected earthquake damage, have been developed by a number of people (Shinozouka 1981; Eguchi 1981; Kennedy/Jenks/Chilton 1990b; Trautmann 1986). These models estimate water pressure and flow available for fire suppression. Both probabilistic and deterministic approaches have been used. Two deficiencies in these models are 1) negative system pressures and 2) inaccuracy of pipeline damage estimates. Existing refined models are proprietary.

Nevertheless, postearthquake water-system modeling is still in its developmental stages. There is vulnerability assessment information available, with varying degrees of accuracy, for most water-system components except those listed below.

- Large diameter steel and concrete pipelines
- Above grade and elevated tanks
- Immersed/floating structures

### VI-2.3 Current Design And Construction Practices And Standards

#### VI-2.3.1 ASCE TCLEE Documents

ASCE TCLEE has been a leader in providing design guidelines for lifeline systems. Documents include:

- *Advisory Notes on Lifeline Earthquake Engineering* (1983)--Primarily component design/evaluation
- *Guidelines for the Seismic Design of Oil and Gas Pipeline Systems* (1984)--Primarily component design/evaluation
- *ASCE Water Treatment Plant Design* (1990)--Primarily component design/evaluation in TCLEE-authored chapter
- *Water Pollution Control Federation (WPCF) Wastewater Treatment Plant Design*

(1991)--Comments on seismic resistant design of wastewater treatment plant facilities in applicable chapters provided by the TCLEE Water and Sewage Committee

- *ASCE Pipeline Design for Water and Wastewater* (1991b)--Chapter on seismic resistant design of pipeline.

### **VI-2.3.2 Guidelines And Standards Of Practice Specifically Developed For Seismic Resistance Of Water And Sewer Facilities**

A consultant (Environmental Quality Systems, Inc. (EQSI, 1980), a utility (East Bay Municipal Utility District (EBMUD) 1980), the Japan Society of Civil Engineers (JSCE) (1988), and the military (Departments of the Army, the Navy, and the Air Force 1982) have all developed guideline type documents for seismic-resistant design of water and sewer facilities.

The EQSI report was thorough but was not presented for consensus approval. It is now somewhat outdated. The EBMUD standard was less comprehensive, had a focused audience, and primarily considered component design/evaluation. The JSCE guideline considers many relevant issues, but primarily considers component design/evaluation.

While the tri-service manual was not developed specifically for water and sewage facilities, it may have the most complete coverage available for such facilities. This document considers some policy, system evaluation, and component design. It includes relevant chapters on mechanical and electrical elements; structures other than buildings, including elevated tanks, vertical tanks, horizontal tanks, and buried structures; and utility systems, including earthquake considerations for utility systems, general and specific planning considerations, and design considerations. Design details are also included.

### **VI-2.3.3 Standards And Guidelines That Address Or Could Potentially Address Water And Sewer Facility System Components**

For the most part, these documents are for specific pieces of equipment or material and do not, with several exceptions, discuss the overall system design or installation of the particular equipment or material. Individual component standards include the following:

- **Tanks**--The AWWA has standards for steel (AWWA D100-84), bolted steel (AWWA D103-87), and prestressed concrete tanks (AWWA D110-86). Each of these three standards has specific requirements for seismic resistant design of these three categories of tanks.

The American Concrete Institute (ACI), Committee 350-2, in *Concrete Sanitary Engineering Structures, Seismic Design* (1987), is completely revising the standard with a chapter addressing seismic design under development. It will address structural concrete design that differs from ACI 318. ACI Committee 344, Prestressed Concrete Tanks, is currently considering whether to update, jointly with AWWA, AWWA D110-86 and ACI 344, specifically addressing seismic design. NSF funding is being sought.

- **Buried Pipe**--The AWWA has standards for ductile iron, steel, concrete, and asbestos cement pipe, fittings, valves, and hydrants. They also have standards for pipe installation. While these standards address such things as materials

## RECOMMENDATIONS FOR LIFELINE SEISMIC STANDARDS

controlling ductility, and bell dimensions controlling spigot insertion length and allowable rotation, there is no specific reference to seismic design. Ductility and bell dimension criteria need to be developed to define the seismic resistance.

AWWA does not have standards addressing joint restraint or flexible coupling systems.

A Japanese firm (Kubota 1981) presents an exhaustive earthquake-design approach for ductile iron. It is also applicable, to some degree, to other types of segmented pipe. Design for wave passage, permanent ground deformation, and dynamic water-pressure gradients are provided.

- **Plant Piping**--Four professional and manufacturer organizations have standards and guidelines for plant piping. The American Society of Mechanical Engineers (ASME) Pressure Vessel and Piping Code 31.1 includes detailed requirements for design of pipe/support structural systems. The code is used in the energy and manufacturing industries. One of the main considerations is for thermal expansion. In general, this approach is much more sophisticated than what is used, or needed, in the water and sewage design industry.

The National Fire Protection Association (NFPA) standard for installation of fire sprinklers includes seismic-resistant pipe-support details (NFPA 1989). This standard is usually only applied to sprinkler systems, although it is a good reference for other types of pipe-support detailing. The American Society of Plumbing Engineers (ASPE) also has developed a good reference source (1986).

The Manufacturers Standardization Society (MSS) has three standards (MSS 58, 69, 89) governing different aspects of pipe supports, none of which considers seismic design (MSS 1975, 1976, 1978). Earthquake design considerations would need to be added.

- **Electrical Equipment**--The Institute of Electrical and Electronic Engineers (IEEE) has a standard for seismic qualification of equipment for the nuclear industry (IEEE 1987). This standard is not applied in the water and sewage industry because of the extreme additional cost of the equipment. There may be an opportunity to take what has been learned in nuclear industry equipment design and apply it to commercial-grade electrical equipment at a moderate cost.

The National Electrical Manufacturers Association (NEMA) is equipment manufacturers driven. They have no provisions for seismic resistance in their full spectrum of electrical equipment specifications normally applied in the water and sewage facility designs. Mitigation activities have focused on the anchorage of this equipment in accordance with the UBC. Anchored electrical equipment has performed well in earthquakes.

- **Wells**--In a telephone conversation with Dave Carpenter of the National Water Well Association, he indicated that the Association has no provisions for seismic design in its guidelines.
- **Buildings And Equipment**--Building codes contain seismic provisions. One of three model building codes listed below is typically used in any given location

throughout the United States.

- *Uniform Building Code*, UBC, International Conference of Building Officials, ICBO, Whittier, California
- *BOCA/National Building Code*, Building Officials and Code Administrators International, Country Club Hills, Illinois
- *Standard Building Code*, of the Southern Building Code Congress International, Birmingham, Alabama

The *NEHRP Recommended Provisions for the Development of Seismic Regulations for New Buildings* (Building Seismic Safety Council 1985) presents a seismic design approach for buildings, while the ASCE Standard 7-88 (ASCE 7-88) presents minimum design loads for buildings and other structures, including earthquake loads.

- **Dams And Diversions**--Congress passed the National Dam Inspection Act of 1972 (Public Law 92-367) as a result of the failure of dams at Canyon Lake, Rapid City, ND; Buffalo Creek Tailings Dam, VA; and dam failures related to Hurricane Agnes. The act required the U.S. Army Corps of Engineers (COE) to inventory, inspect, and review the safety of all non-Federal dams in the United States. The COE was to inspect and review all dams that met criteria related to the height of the dam and capacity of the reservoir behind the dam, following the law used in California since 1929. The COE could delegate and provide funds for this task to the States that could do their own inspection and review.

The COE, with limited funds, began compiling an inventory of non-Federal dams on July 1, 1974, using the California criteria. It was not until December 1977, as a result of the Kelly Barn Dam, Tocco Falls, Georgia, failure that President Jimmy Carter authorized the funding of a four-year program to complete the inventory and inspect about 9,000 non-Federal dams. The inventory identified 63,000 (80,000 in 1991) non-Federal dams, and the program inspected 8,819 potentially high-hazard dams. Since the completion of the program the Federal Emergency Management Agency (FEMA) has supported the Association of State Dam Safety Officials training program for dam safety and updating the inventory of non-Federal dams.

In October 1979, as a result of the failure of the Teton Dam on the Snake River in Idaho in 1976, President Carter directed the implementation of the then newly developed Federal Guidelines for Dam Safety on all Federal dams. Reports were to be provided to the Director of FEMA on the implementation program. FEMA coordinated the formation of the Interagency Committee on Dam Safety (ICODS) bringing together all Federal agencies involved in design and construction of dams and reservoirs. This committee included the COE, U.S. Bureau of Reclamation, Soil Conservation Service, Tennessee Valley Authority, Nuclear Regulatory Commission, Bureau of Mines, Federal Energy Regulatory Commission (FERC), etc.

The United States Committee on Large Dams (USCOLD 1985) Earthquake Committee is developing seismic guidelines on appurtenant structures such as

## RECOMMENDATIONS FOR LIFELINE SEISMIC STANDARDS

spillways, inlets, and outlets, for dams and reservoirs.

The Bureau of Reclamation has developed several documents on design and instrumenting dams (Bartholomew 1987a,b). The California Department of Water Resources has publications on small dam design (1986). The National Research Council published several documents on dam safety specifically addressing seismic issues (1983, 1985).

Dams and reservoirs are designed on a case-by-case basis, since they are constructed at different site conditions with different geology and seismicity. It would be difficult to develop standards; therefore a plan to develop standards for dams and reservoirs will not be included in this Water and Sewer chapter.

### **VI-2.4 Current System Emergency Operation Planning, Response, and Recovery Documents**

Recent emergency management guides for cities (ICMA 1991), and emergency management guides for water systems (California Department of Water Resources 1985) are available but not widely used.

### **VI-2.5 Available Knowledge To Improve Existing Practice**

A literature search was conducted through the National Center for Earthquake Engineering Research (NCEER) and the ASCE Engineering Societies Library to identify any additional seismic standards documents previously unknown to the author. The Quakeline Search, National Technical Information Service, COMPENDEX PLUS, and TRIS databases were investigated and pertinent references not previously identified reviewed.

## **VI-3. STANDARDS DEVELOPMENT ACTIVITIES**

### **VI-3.1 Introduction**

This section discusses elements of a lifeline standard, presents a brief scope statement for each standard, provides a recommended priority for development, proposes an estimated schedule and budget, and identifies possible organizations for draft standard development.

If inadequate information is available for development of a standard, it is so identified, and required research with associated costs and schedule estimated. The basis of this section is the inventory and review developed in the previous section.

It is important that standards be developed in the technical arena where they will be used. For example, there are some ASME pressure vessel and piping standards used in the energy industry that incorporate seismic considerations. Other standards, which do not consider seismic considerations, are used in the water industry. This plan proposes activities to facilitate appropriate technology transfer.

### **VI-3.2 Elements Of A Lifeline Standard--Water And Sewer**

A lifeline earthquake code or standard should consider the five elements listed below.

1. **Policy Statement**--Defining the system performance requirements and

operational expectations during and following the earthquake.

2. **System Evaluation Standards**--Defining how the system performance requirements and operational expectations during and following the earthquake can be evaluated vis-à-vis the policy statement, indicating deficiencies to be corrected.
3. **Component Design/Evaluation Standards**--Defining the detailed engineering design/evaluation of new, replacement, or existing components, which would also serve as input to the system evaluation.
4. **Equipment And Material Standards**
5. **System Emergency Operation Planning, Response, And Recovery**

A lifeline standard should ideally address both new and existing construction when modified. Policy and system evaluation apply to all systems. Essentially, all systems are existing, but have new components added as the system expands, and replace system components that have worn out. Component design/evaluation and equipment and material standards ideally relate to both new and existing facilities; new for design and equipment specification, and existing for performance evaluation.

Public law 101-614 is explicit about addressing design and construction methods for new and existing structures. Elements 1, Policy Statement, 3, Component Design/Evaluation Standards, and 4, Equipment and Material Standards, are clearly included in those categories. In addition, there has been discussion in the industry that, because of the "system" nature of lifelines, Element 2, System Evaluation Standards, and Element 5, System Emergency Operation Planning, Response, and Recovery, should be incorporated in any comprehensive approach to post-earthquake system functionality.

### **VI-3.3 Need for a System Seismic Vulnerability Assessment**

Lifeline systems differ substantially from buildings with regard to seismic resistance. System evaluation, not a part of building codes, should be considered for lifeline systems.

System evaluation is not required in building design, since there is no interrelationship between buildings, new or existing. As new buildings are constructed in accordance with seismic design codes, the overall vulnerability of real estate is decreased.

If the system evaluation approach is not incorporated in lifeline standards, there would be a concern that the vulnerability of lifeline systems could remain high for many years, even though new facilities were being designed in accordance with seismic resistance standards.

Lifeline system vulnerability is not necessarily reduced as new components are constructed. In general, most existing or new lifeline systems have key components, such as cast-iron pipe, that will last for many years before replacement would be warranted. However, if that cast-iron pipeline is located in a liquefiable area, it is highly vulnerable to earthquake damage, and could cause a significant portion of the distribution system to become inoperable following an earthquake. Therefore, achieving system component earthquake standards alone may not result in a system's meeting the criteria identified in the policy statement, and thus, a system evaluation standard should be required.

## RECOMMENDATIONS FOR LIFELINE SEISMIC STANDARDS

Conducting a system-wide seismic vulnerability assessment also offers the opportunity to identify system deficiencies and develop an awareness of potential earthquake damage.

There are disadvantages to including system evaluation as part of the standard. Technically, writing a standard for system evaluation may be much more complicated than doing the same for system components. A system evaluation standard could rely on earthquake damage algorithms that are still early in their development. Liquefaction microzonation mapping is still in its infancy, making quantitative liquefaction maps suspect. The premise of system evaluation is that system owners will be required to upgrade their systems based on the results. Even if compliance is required over a long time period, it may still be expensive.

The author and the advisory panel have concurred that it is appropriate to develop a design guideline for system evaluation as part of this program.

### **VI-3.4 Basis For Schedule And Cost Estimates**

The author, the TCLEE Water and Sewage Committee project advisors, and the ASCE Codes and Standards staff were involved in estimating budgets and schedules presented herein by comparing the proposed scope with projects of the same approximate size. Each proposed activity was compared with other proposed activities to assess relative budgets. In general, one person year of professional labor cost was budgeted at \$100,000. Each activity was budgeted by adding 50 percent to the professional labor cost to cover travel and support services.

It is the intent that standards will be initially developed as prestandards or draft standards followed by a consensus building and approval process. The prestandard development process could be undertaken by one of many organizations. The consensus/approval process would be undertaken by a codes and standards organization such as ASCE. The proposed budgets include development of the prestandard and the financial support for a facilitator during the consensus building/approval process. The schedules include time for both processes.

### **VI-3.5 Common Areas Between Lifelines**

There are a number of administrative and technical areas that are common to multiple types of lifeline systems. Policy development should be a coordinated effort between all lifelines areas because of their interdependence. Also it is appropriate that overall lifeline earthquake mitigation be balanced between lifelines.

Dams and diversions are significant components of water systems, hydroelectric power generation systems, and transportation systems. Standard guidelines should be developed for seismic design and evaluation of dams. Activities and associated budgets for dams are not included in the water and sewer chapter.

Liquefaction mapping is valuable for all buried utilities, particularly water, sewer, gas, liquid fuels, and buried electrical and communications cables and conduits. Activities and budgets are included in this chapter to address liquefaction mapping. It would be appropriate to conduct these activities jointly with other lifelines.

A standard for retaining-wall load criteria is important for water and sewer facilities, including treatment structures and pump stations as well as transportation facilities, including highway bridge abutments and marine terminal facilities. One standard task is included for water and



sewer. That effort should be coordinated with the transportation area.

Buildings are found in all lifeline systems. In water and sewer systems they are used for operations, maintenance, treatment facilities, and pump stations. This author and document reviewers agreed that it is appropriate to rely on existing earthquake building design standards, with appropriate importance factors, and building retrofit standards under development. If the other lifeline systems develop standards for buildings focusing on postearthquake functionality, the water and sewer technical community would likely make use of them. Those standards however are considered to have a low priority. No task is included for water and sewer.

Steel pipelines and steel tanks are used in both the water and sewer industry as well as the gas and liquid fuels area. However, the range in geometry of steel tanks used in the liquid fuels industry is only a small segment of the range used in the water industry. Similarly, steel pipe is only a small segment of the total pipe installed in the water industry. The water and sewer industry designers are essentially a completely different group of professionals than those designing gas and liquid fuel systems. Therefore, it is recommended that research and development work in these areas be common, but that standards development should be coordinated but separate.

Nonstructural items, electrical and mechanical equipment, and plant piping are common to many lifelines. A common standard should be developed for electrical and communications cabinets, emergency engine-generator sets, equipment anchorage, small diameter pipe, and nonstructural items. Activities and associated budgets are included in the water and sewer section for several of these activities.

### VI-3.6 Policy Statement

The policy statement would define postearthquake system operating expectations. The statement would be parallel to the policy statement in the SEAOC Blue Book which defines building earthquake performance. The policy statement would set requirements for two earthquakes. For example:

- **Moderate Earthquake**--Minor damage, no loss of function
- **Major (Catastrophic) Earthquake**--Moderate damage, system 75 to 90 percent functional to provide fire protection to key areas. Essential system functional restoration within 7 to 14 days. Limited exposure of employees or public to injury and property damage.

For a major earthquake, fire protection capability would be required for key areas, for example, areas with a real estate density exceeding some given level. A mechanism to supply drinking water within three days following the earthquake would be required, even if it was provided through temporary facilities. Essential system functional restoration would be required within some predefined period. Establishing the required restoration schedule would provide useful information for emergency planners.

In defining key areas, consideration might be given to vulnerability to fire for the fire protection requirement. For example, more stringent major earthquake requirements (no loss of function) might be applied to sections of systems serving central business district areas with a high population density and areas with a type of construction that would be particularly vulnerable to fire.

## RECOMMENDATIONS FOR LIFELINE SEISMIC STANDARDS

The policy statement should be developed in a coordinated effort with the other lifelines. As lifelines rely on each other for operation, it is important system functionality expectations be developed with the other systems taken into account. For example, telecommunication systems rely on a water supply for system cooling requirements. Similarly, ground water supplies rely on electrical power to operate well pumps.

The policy statement should tie the earthquake designation requirements to some existing seismic zonation mapping system such as UBC or NEHRP. Earthquake ground shaking and the associated return periods in those maps define earthquake hazard.

The policy statement would provide guidance on a schedule for meeting the policy requirements. It would be expected that those schedules would be based on risk as defined in the adopted seismic zonation map system. For example, West Coast facilities would have a shorter time to reach compliance than those on the East Coast.

In general, it would be the intent that all new construction and component replacement be designed in accordance with the new standard upon its approval. The system evaluation would be conducted within a reasonable time period following approval, say two to three years. Depending on the specific requirements of the third and fourth standard elements, there may be requirements to upgrade special categories of deficiencies within a reasonable time period following system evaluation. A period of five years is proposed for a starting point for discussion. These special categories would include things such as equipment anchorage and addition of snubbers to vibration isolator mounted equipment.

It is the intent that each system comply with the policy statement postearthquake functional requirements within an extended planning period depending on risk. For example, for Los Angeles and New York, the compliance schedule might be 20 and 50 years, respectively. The compliance schedule is a significant discussion point to be addressed during policy development.

It would be the intent that each system would be upgraded continuously over the compliance period, so that at the end, a major upgrade program would not be required. The concept is that, for the most part, system owners could incorporate seismic planning and design into the regular capital improvement planning program. When considered as one of many criteria in developing their capital improvement plan, the cost specifically for seismic upgrade would be minimal.

As part of the policy statement, resistance to damage from an earthquake should be prioritized considering both system component failures and loss of function of the overall system. Earthquake damage to water systems should be mitigated in accordance with the following priority:

1. **Loss Of Life And Injury**--Fire protection, flooding, building collapse, hazardous chemical release, etc.
2. **Public Health**--Drinking water and sanitary needs, contamination of drinking water, with a priority for emergency health care facilities.
3. **Economic Impact**--Flooding damage, business interruption, recovery costs
4. **Residential Uses**
5. **Irrigation**

Earthquake damage to sewer systems should be mitigated in accordance with the following priority:

1. **Loss Of Life And Injury**--Fire (combustible gas), building collapse, hazardous chemical release, etc. Figure 7 shows a vulnerable chlorine container installation that could potentially release chlorine following an earthquake.
2. **Public Health**--Sanitary disposal, control of sewage backup. Sewage overflowing from damaged sewers is a source of pollution and possible cause of disease.
- 3A. **Economic Impact**--Flooding damage, business interruption, residential impact, recovery costs.
- 3B. **Environmental Impact**--Sewage treatment.

Federal agencies likely to have responsibility for policy are NIST, FEMA, and the EPA. They should enlist ASCE TCLEE and/or NCEER, with support from the AWWA for water, and the WPCF for sewer. The first priority for water supply is fire protection. Therefore, organizations such as the National Fire Protection Association and the Insurance Services Office, Inc. (who provide a fire protection rating service, considering fire department and water system capabilities, to insurance companies), should be involved. The organization given the responsibility for development of the policy statement should be organized to either have paid staff to develop the statement or to hire a consultant to carry out the work under direction of the organization.

The policy statement should be developed jointly with the system evaluation standard. The details included in the system evaluation will impact compliance schedules and cost impacts to system owners. Refer to the system evaluation section, following, for a budget for this process.

### VI-3.7 System Evaluation

The system evaluation standard would provide detailed direction on assessing each system to allow comparison of the results with the policy statement. It is the intent that it be a planning level vulnerability assessment, with allowance for input of detailed vulnerability assessment results when they were available. Detailed component vulnerability assessment standards would be included in this third element. The system evaluation standard would include a procedure and evaluation data to assess the system's expected performance. Both facility component loss estimates and repair times would be included.

Recent studies have involved large systems, but with many simplifying assumptions. They have all been computer based. The standard should allow several approaches, both computerized and manual, depending on the size and complexity of the system. A simple approach to system evaluation should be available for small systems. If a computer-based approach is included in the standard, it should be available in public domain software.

The focus of additional research and development, with NEHRP funding, should be in areas where upgrade costs are high, such as pipelines and tanks, and avoid areas where upgrade costs are low such as equipment anchorage.

One of the areas requiring additional study to increase accuracy of loss models is geotechnical

## RECOMMENDATIONS FOR LIFELINE SEISMIC STANDARDS

hazard microzonation techniques, particularly in areas of liquefaction. These are local maps that would be developed by local or regional jurisdictions. This type of information is not found in regional hazards mapping previously developed in the NEHRP program. Figure 8 shows liquefaction microzonation mapping for a portion of Seattle (Kennedy/ Jenks/Chilton, 1990b). Recent approaches have considered both probabilistic liquefaction occurrence and permanent ground deformation mapping. These approaches must be standardized and simplified to allow their economical application. By observation it would appear that even more pipeline damage is associated with ground failure than what has been recorded. It may have been recorded as failure associated with wave passage because there have been no obvious surface displacements. This is also related to liquefaction microzonation mapping problems.

There is a concern that failure rates developed for steel pipe have used smaller diameter steel pipe, possibly heavily corroded, as a basis. Large diameter steel pipelines and aqueducts form key elements of many major water systems. An accurate assessment of their vulnerability should be developed. There is a similar but lower priority concern for smaller diameter pipe for both water and sewer. Figure 9 shows a damage algorithm for sewers subjected to permanent ground deformation (HLA, 1991).

AWWA D100 has had seismic provisions since 1979. With each earthquake, steel tanks continue to be damaged. While some work has been done to correlate tank damage to height to diameter ratios (Eguchi, 1983) there has been no work to correlate that damage with AWWA D100.

Federal agency responsibility could again be assumed by NIST, FEMA, and the EPA. They should employ the assistance of professional organizations currently involved in water and sewer system earthquake vulnerability assessment, with support from NIST. Currently, ASCE TCLEE and NCEER are the only organizations and members actively involved in the issues discussed above. The organization given the responsibility for development of Elements 1 and 2 prestandards (Tasks 1.1 through 2.1.3) should be organized to either have paid staff to develop the documents or work with a consultant to carry out the work under direction of the organization. A standards organization with a broad representation from the industry, similar to the ASCE Committee on Codes and Standards, should conduct the consensus building and approval process. Development of Element 2 should be done in conjunction with Element 1.

The remaining tasks, 2.2.1 through 2.4, are technically oriented and should require a minimum amount of policy guidance. They should be carried out by private contractors or universities.

Policy statement and system evaluation tasks, including standards development, research and development, training materials development, and field applications, should include:

- 1.1 Develop a policy statement standard and accompanying commentary. The statement would include postearthquake operating expectations for two "design" earthquakes, tie the standard to existing seismic zonation mapping, establish mitigation priorities, provide guidance on a compliance schedule, and define categories where upgrade would be required. Priority 1, \$100,000.
- 2.1.1 Develop system planning and evaluation standard guideline and accompanying commentary. This document should provide guidelines for both large and small systems with the commensurate requirement level of effort for each. This is an overall standard guideline and would use the standard guidelines for liquefaction mapping and treatment plant evaluation described below. Note that this task requires extensive technical work in standardizing current system evaluation approaches. Priority 1, \$250,000.

## WATER AND SEWER LIFELINES

- 2.1.2 Develop a quantitative liquefaction mapping standard procedure for use in liquefaction microzonation mapping for pipeline damage evaluation. This standard procedure would be based on current technology that could be widely applied throughout the United States. Priority 1, \$100,000.
- 2.1.3 Develop a treatment plant system evaluation standard guideline to assess the vulnerability of the overall treatment plant functionality. The guideline should provide direction on assessing the vulnerability of individual treatment plant components and their required interaction to provide a functional treatment system. Priority 1, \$100,000.
- 2.2 Research and Development Tasks--Each of the tasks in this group are independent.
  - 2.2.1 Further develop a standardized method for quantitative liquefaction mapping for use in the system evaluation standard. Considerations should include methods to estimate permanent ground deformations and patterns of those deformations based on the local geotechnical configuration. This should be developed as a plug-in module to task 2.1.2, above. This task should be performed in two phases; Phase 1, Establish Practicality, Priority 2, \$100,000; and Phase 2, Continued Research, Priority 3, \$150,000.
  - 2.2.2 Develop improved pipeline loss algorithms specifically addressing large diameter (over 36-inch) steel and concrete pipe. The focus of this task should be on damage associated with permanent ground deformation. This should be developed as a plug-in module to task 2.1.1, above. Priority 1, \$100,000.
  - 2.2.3 Develop improved pipeline loss algorithms addressing pipeline damage for a range of soil conditions. The focus of this activity is to further define wave propagation and permanent ground deformation (liquefaction, lateral spread, settlement) pipeline damage data and mechanisms for commonly found pipeline materials and designs for diameters ranging from 4-inch to 30-inch. This task should be developed as a plug-in module to activity 2.1.1, above. Priority 3, \$150,000.
  - 2.2.4 Develop improved loss algorithms for elevated steel tanks and standpipes based on tank age, geometry, and basic structural characteristics. This should be developed as a plug-in module to task 2.1.1, above. Priority 3, \$100,000.
- 2.3 Develop a training program and documentation for standards implementation. Note that this task excludes the actual training. Priority 2, \$200,000
- 2.4 Application by field trials of policy and system evaluation draft standards, including estimated cost impacts, to four water and one sewer system representing a distribution of system size and location. The field trials should be undertaken by those not associated with the development of the standard. They could be performed by either a consultant or by "in-house" staff. Priority 2, 3 at \$100,000 each for a subtotal of \$300,000, and Priority 3, 2 at \$100,000 each for a subtotal of \$200,000.

The budget subtotal for Elements 1 and 2 is \$1,850,000 divided into priority 1, \$650,000; priority 2, \$600,000; and priority 3, \$600,000.

## RECOMMENDATIONS FOR LIFELINE SEISMIC STANDARDS

### VI-3.8 Component Design/Evaluation

This section defines the engineering detailed design of new and replacement components and evaluation for existing components to input into the system evaluation. A policy statement defining functional expectations of the particular component should also be included. Design of pipeline, well, tank, and equipment installations will be addressed, but design of the materials and equipment components is excluded. This role has historically been taken on by professional organizations, such as ICBO, ASCE TCLEE, ASME, and to some degree, AWWA tank standards.

Component design codes are found in such documents as the Uniform Building Code and the American Water Works Association's D100, Standard for Welded Steel Tanks for Water Storage. Additional standards can be developed where they do not exist, such as seismic-resistant design of pipelines (ASCE, 1991b) and existing tank evaluation and upgrade. Figure 10 shows a seismic upgrade to a standpipe. Component design would be used both to specify new facilities as well as assess the vulnerability of existing facilities.

There is a substantial amount of background information available such as advisory notes, guidelines, and criteria covering various segments of this area in the water and sewer industry. However, it is not in standards format nor approved through a consensus process.

There is a lack of detailed seismic design information for wells although the National Well Water Association and the California Department of Water Resources have well design documents to which seismic design considerations could be added. There is also a lack of detailed design information covering submerged elements in tanks and, to a lesser degree, pipelines.

Tasks should include:

- 3.1 Develop an umbrella design standard for water and sewer. It is the intent to develop a comprehensive standard for application to water and sewer facilities. The umbrella standard would reference appropriate existing or soon to be existing guidelines, standards, or codes such as those listed below, as well as new guidelines, standards, or codes to be developed herein. It should also define appropriate criteria required as input to the referenced documents.

- Tank Design - AWWA
- Tank Design - ACI 350
- Pipeline Design - ASCE, AWWA
- Building Codes, ASCE 7-88, etc.
- Plant Piping Design - NFPA, ASME, etc.
- Bridge design - ATC-6
- Equipment installation
- Nonstructural elements

Priority 1, \$250,000, ASCE TCLEE/NCEER

- 3.2.1 Develop a design standard for above and below ground pipelines (excluding plant piping), both continuous and segmented, including permanent ground deformation and wave propagation effects due to earthquakes. Also include pipeline and appurtenance design details such as manholes, building connections, services, valve boxes, and pressure reducing valve installations. Priority 1, \$400,000, NCEER, ASCE TCLEE,

## WATER AND SEWER LIFELINES

ASCE Pipeline Division, AWWA, with contractor support.

- 3.2.2 Conduct pipe testing required in the development of the pipeline standard above. Priority 2, \$200,000
- 3.3 Conduct research in the area of active control systems for postearthquake water system control. This should include evaluation of automatic versus manual operation, system operation and vulnerability considerations, telemetry, actuator energy supply, water contamination, and system shutdown liability issues. Priority 1, \$150,000.
- 3.4 Develop a design standard for plant piping. Pipe diameter and content support policy, earthquake loading, support type and spacing, thermal expansion/contraction considerations, flexibility/offset requirements, and pipe material requirements, should be included. Priority 3, \$100,000
- 3.5 Develop a standard for earthquake generated earth pressures on retaining walls, buried tanks, and basins. Priority 3, \$100,000, NCEER with contractor support.
- 3.6 Develop a standard to mitigate the effects of sloshing water in tanks, including loadings, wave heights and submerged and floating tank appurtenances design. Priority 1, \$150,000, ACI, AWWA, WPCF, ASCE TCLEE, university or contractor.
- 3.7 Further develop a standard for steel tanks to be used by all lifelines, particularly water and liquid fuel. Priority 3, \$250,000, AWWA, American Petroleum Institute, ASCE TCLEE, ASME, with support from contractor.
- 3.8.1 Develop a standard to evaluate existing steel elevated tanks and standpipes. Priority 2, \$150,000, ASCE TCLEE or AWWA with support from contractor.
- 3.8.2 Develop a standard guideline to retrofit existing steel elevated tanks and standpipes. Priority 2, \$150,000, ASCE TCLEE or AWWA with support from contractor.
- 3.8.3 Conduct lab tests support development of the tank retrofit guideline to retrofit existing steel tanks. Priority 2, \$250,000.
- 3.9 Develop a design standard for intake towers. Priority 3, \$100,000, ICODS, USCOLD, ASCE, FERC, with support from university or contractor .
- 3.10 Develop design standard for water wells to be included in existing standards. Priority 3, \$150,000, National Well Water Association, ASCE, AWWA, with contractor support.
- 3.11 Develop a design and retrofit standard to be used by all lifelines for nonstructural items. Priority 2, \$150,000, ATC, ASCE TCLEE, ASME, with support from contractor.
- 3.12 Develop a standard to be used by all lifelines for emergency generator systems and battery installations (This excludes generator qualification). Priority 1, \$100,000, ASCE TCLEE, ASME, ATC, NEMA, IEEE, with support from contractor.
- 3.13 Develop a training program to educate the design/owner community on use of the standards developed in this section. Priority 2, \$200,000, ASCE TCLEE, NCEER, AWWA, WPCF, with support from contractor.

## RECOMMENDATIONS FOR LIFELINE SEISMIC STANDARDS

The budget subtotal for Element 3 is \$2,850,000 divided into priority 1, \$1,050,000; priority 2, \$1,100,000; and priority 3, \$700,000.

### VI-3.9 Equipment And Material Standards

Equipment and material standards are usually set by the manufacturing industry, pushed by market demand. NEMA and AWWA pipe standards are examples. Few of these manufacturing standards address earthquake considerations, primarily due to a lack of market demand. This deficiency should be mitigated by the relevant manufacturing industry as directed by their users with incentive provided by the Federal Government. Activities in this element should be funded jointly at equal levels by the Federal Government and industry.

In the electrical cabinet industry, we can apply what we have learned from equipment qualification in the nuclear industry. It would be the intent to add the few details that harden electrical equipment, and make the equipment available in regular production runs for the minimal additional cost of the detail.

Water and wastewater process equipment is particularly vulnerable to sloshing water. This equipment includes flocculators, clarifiers, baffles, and sludge digester covers. There are no standards for this type of equipment. Liquid sloshing loads are extreme. Attempts to strengthen baffle-like structures result in unrealistically heavy elements. The suggested approach is to use fused or break-away connections that can be easily repaired after the earthquake. Care must be exercised in the design to keep the broken item from falling on other equipment, causing secondary damage.

Tasks should include:

- 4.1 Design and test seismic joints for buried pipe to provide additional rotation, extension/compression capability, and material ductility. See activity 3.2.1. Priority 1, \$100,000 Federal, \$100,000 Industry, AWWA, WPCF, Pipe Manufacturers, ASCE TCLEE, NCEER.
- 4.2 Incorporate seismic provisions into sewer manhole connection appurtenance standards. See activity 3.2.1. Priority 3, \$50,000 Federal, \$50,000 Industry, ASCE TCLEE, NCEER, WPCF.
- 4.3 Incorporate seismic design provisions into electrical commercial equipment standards commonly used in the water and sewer industry based on what has been learned in the nuclear industry. See activity 3.11. Priority 3, \$100,000 Federal, \$100,000 Industry, NEMA, IEEE, ASCE TCLEE, Instrument Society of America
- 4.4 Incorporate seismic provisions into pipe-support standards used in the water and sewer industry. See activity 3.4. Priority 3, \$100,000 Federal, \$100,000 Industry, ASCE TCLEE, Pipe-Support Manufacturers, AWWA, ASME, WPCF, NFPA, with support from a contractor.
- 4.5 Incorporate seismic-induced sloshing water considerations into standard designs for water and wastewater treatment process equipment designs. See activity 3.6. Priority 2, \$150,000 Federal, \$150,000 Industry, Equipment Manufacturers, ASCE TCLEE, contractor,



The Federal Government budget subtotal for Element 4 is \$500,000 divided into priority 1, \$100,000; priority 2, \$150,000; and priority 3, \$250,000. These budgets would be matched by industry.

### **VI-3.10 System Emergency Operation Planning, Response, and Recovery**

System emergency operation planning, response, and recovery is the most cost-effective way to mitigate the impact of earthquakes on water and sewer systems. Because of the wide variation in the size and type of water and sewer service provider organizations, it does not seem to be appropriate to have a standard or code. However, a guideline similar to the *Emergency Handbook for Water System Managers* produced by the State of California's Department of Water Resources is recommended.

The document should establish guidelines for responding to emergencies such as hazardous material release, fire, explosion, hurricane/tornados and snow/ice storms, as well as earthquakes.

A process should be developed to ensure that all water and sewer agencies have an effective emergency plan in place that is practiced on an annual basis. The earthquake component of the emergency plan should define restoration priorities following the emergency response.

Tasks include:

- 5.1 Develop a guideline for development of system emergency operation planning, response, and recovery for water and sewer system owner/operators. Priority 1, \$250,000, FEMA, AWWA, WPCF, EPA, ICMA, ASCE TCLEE, with support from universities and contractors.
- 5.2 Develop a training program and procedures for conducting drills, using the guideline as a basis, to educate water and sewer system operations personnel to develop emergency plans. This program should be integrated with FEMA's ongoing emergency training program at Emitsburg, Maryland. Priority 2, \$150,000, FEMA, AWWA, WPCF, with support from contractors.
- 5.3 Inventory adoption of emergency plans for water and sewer systems across the United States and initiate a program to develop and evaluate alternative mechanisms to insure that every water and sewer agency currently has or develops, maintains, and practices an emergency response plan. Implement the recommended solution. Priority 3, \$100,000, FEMA, AWWA, EPA, ICMA, ASCE TCLEE, with support from universities and contractors.

The budget subtotal for Element 5 is \$500,000 divided into priority 1, \$250,000; priority 2, \$150,000; and priority 3, \$100,000.

The budget total for Elements 1 through 5 is \$5,700,000 divided into priority 1, \$2,050,000; priority 2, \$2,000,000; and priority 3, \$1,650,000.

### **VI-3.11 Schedule**

The schedule for the overall program would, for the most part, be completed over a six-year period. Development of the policy statement and plan guideline would take two and one-half

## RECOMMENDATIONS FOR LIFELINE SEISMIC STANDARDS

years followed by field application, and the consensus building/approval process. Priority 1, 2, and 3 research and development activities would each last two years, and be conducted in series for a six year duration. The completion of training documents would lag six months beyond the final standard approval in order to incorporate any final changes to the standard. The proposed schedule is listed below and shown graphically in Figure 11.

<b>PROPOSED SCHEDULE</b>	
6 months - workshop (initial notice publication to final report)	
18 months - individual contractors	
3 months - review committee/workshop	
3 months - revise draft	
12 months - apply draft standard to test systems (activity 2.4)	
6 months - revise draft	
<u>24 months - consensus approval process</u>	
72 months - total	

Component and equipment standards development and approval are anticipated to take four years. Since they are less complex than the plan guideline, standard development should be somewhat faster, and there should be no need for field application. In order to more evenly distribute cash flow and technical resources, standards tasks for priority 1, 2, and 3 activities, respectively, are staggered by two years. Priority 1 and 2 standards tasks would be completed in a similar timeframe as the policy and system standards development. Priority 3 task completion would lag by two years. Training for component standards would be provided at the same time as that for policy and system standards use.

Emergency planning standard guidelines development and approval would be conducted over a four-year period, and training materials developed in parallel with other training material development activities.

### VI-4. ACKNOWLEDGMENTS

This chapter was developed by the American Society of Civil Engineers, Technical Council on Lifeline Earthquake Engineering (ASCE TCLEE) Water and Sewage Committee as a consultant to NIST. Kennedy/Jenks Consultants, represented by Donald B. Ballantyne, is subconsultant to ASCE TCLEE.

Significant input and review was provided by ASCE TCLEE Committee Members Mr. Walter Anton, Seattle Water Department; Mr. Fred Barker, Los Angeles Department of Water and Power; Mr. Holly Cornell, CH2M Hill; Mr. William Elliott, Portland Water Bureau; Ms. Laurel Harrington, Seattle Water Department; Ms. Julie Lie, Metropolitan Water District of Southern California; Mr. LeVal Lund, Civil Engineer, formerly Los Angeles Department of Water and Power; and Professor Michael O'Rourke, Rensselaer Polytechnic Institute.

### VI-5. REFERENCES

American Concrete Institute, *Concrete Sanitary Engineering Structures*, ACI Committee 350

## WATER AND SEWER LIFELINES

Report, Detroit, Michigan, June 1977.

American Insurance Association, *National Building Code*, New York (most recent edition).

American Society of Civil Engineers 7-88, *Minimum Design Loads for Buildings and Other Structures*, ASCE, New York, NY.

American Society of Civil Engineers, American Water Works Association, *Water Treatment Plant Design*, Second Edition, McGraw-Hill, 1990.

American Society of Civil Engineers, Pipeline Division, Committee on Pipeline Planning, *Pipeline Design for Water and Wastewater*, New York, 1991b.

American Society of Civil Engineers, Technical Council on Lifeline Earthquake Engineering, *Advisory Notes on Lifeline Earthquake Engineering*, Technical Council on Lifeline Earthquake Engineering, New York, 1983.

American Society of Civil Engineers, Technical Council on Lifeline Earthquake Engineering, Gas and Liquid Fuels Committee, *Guidelines for the Seismic Design of Oil and Gas Pipeline Systems*, Technical Council on Lifeline Earthquake Engineering, New York, 1984.

American Society of Civil Engineers, Technical Council on Lifeline Earthquake Engineering, *Seismic Loss Estimates For a Hypothetical Water System - A Demonstration Project*, by the Water and Sewage and Seismic Risk Committees of the Technical Council of Lifeline Earthquake Engineering, Edited by Craig E. Taylor, ASCE, June 1991a.

American Society of Plumbing Engineers, "Seismic Protection of Plumbing Equipment," *ASPE Data Book Volume 2*, Special Plumbing Systems Design, Chapter 19, ASPE 1986.

American Water Works Association, *AWWA Standard for Welded Steel Tanks for Water Storage*, ANSI/AWWA D100-84, 1984; *AWWA Standard for Factory-Coated Bolted Steel Tanks for Water Storage*, ANSI/AWWA D103-87, 1987; *AWWA Standard for Wire-Wound Circular Prestressed-Concrete Water Tanks*, ANSI/AWWA D110-86, 1986.

Applied Technology Council, "Seismic Design Guidelines for Highway Bridges," ATC-6, Redwood City, CA, 1981.

Applied Technology Council, *Earthquake Damage Evaluation Data for California*, ATC-13, Redwood City, CA, 1985.

Applied Technology Council, *Evaluating the Seismic Resistance of Existing Buildings*, ATC-14, Redwood City, CA, 1987.

Applied Technology Council, FEMA Earthquake Hazards Reduction Series 41, *Rapid Visual Screening of Buildings for Potential Seismic Hazards: A Handbook*, ATC-21, Redwood City, CA, 1988.

Applied Technology Council, FEMA Earthquake Hazards Reduction Series 47, *A Handbook for Seismic Evaluation of Existing Buildings (Preliminary)*, ATC-22, Redwood City, CA, 1989.

Applied Technology Council, *Seismic Design and Performance of Equipment and Nonstructural*

## RECOMMENDATIONS FOR LIFELINE SEISMIC STANDARDS

*Elements in Buildings and Industrial Structures*, Report No. ATC-29, Funded by National Center for Earthquake Engineering Research and the National Science Foundation, Redwood City, CA, 1991.

Applied Technology Council, *Seismic Vulnerability and Impact of Disruption of Lifelines in the Conterminous United States*, Report No. ATC-25, Redwood City, CA, 1991.

Barenberg, Michael E., "Correlation of Pipeline Damage with Ground/Motions," *Journal of Geotechnical Engineering*, ASCE, Vol. 114, No. 6, June 1988, pp. 706-711.

Bartholomew, Charles L.; Bruce C. Murray; Dan L. Goins; *Embankment Dam Instrumentation Manual*; United States Department of Interior, Bureau of Reclamation; January, 1987a.

Bartholomew, Charles L.; Michael L. Haverland; *Concrete Dam Instrumentation Manual*; United States Department of Interior, Bureau of Reclamation; October, 1987b.

Building Officials and Code Administrators International, *BOCA/Basic Building Code*, Homewood, Illinois (most recent edition).

Building Seismic Safety Council, FEMA Earthquake Hazards Reduction Series 17, *NEHRP Recommended Provisions for the Development of Seismic Regulations for New Buildings*, Part 1 Provisions, BSSC, Washington, D.C., 1985.

California Department of Water Resources, Division of Safety of Dams, *Guidelines for the Design and Construction of Small Embankment Dams*, Sacramento, California, March, 1986.

California Department of Water Resources, *Emergency Handbook for Water Systems Managers*, 1985

Congressional Record, Vol 136 (1990), Public Law 101-614, Nov. 16, 1990.

Cynga Energy Services, *Seismic Reliability Study of the Seattle Water Department's Water Supply System*, Job No. 88175, Report No. 1, Revision B, Walnut Creek, CA, July 1989.

Dames & Moore, *Seismic Risk Assessment of Local Water Production Facilities in the Service Area of the Metropolitan Water District of Southern California*, Final Report, D&M Job No. 02269-019-166, January 1991.

Departments of the Army, the Navy, and the Air Force, *Technical Manual - Seismic Design for Buildings*, (Tri-Service Manual) Army Technical Manual No. 5-809-10, NAVFAC P-355, Air Force Manual No. 88-3, Chapters 10-13, February 1982.

East Bay Municipal Utility District, *Engineering Standard Practice on Seismic Design*, Oakland, CA, October 1980.

Eguchi, R. T.; Philipson, L.L.; Legg, M. R.; Wiggins, J. H.; and Sloss, J. E.; "Earthquake Vulnerability of Water Supply Systems," *Lifeline Earthquake Engineering*, p. 277-292, American Society of Civil Engineers, New York, 1981.

Eguchi, Ronald; Taylor, Craig; Hasselman, T.K.; *Seismic Component Vulnerability Models for Lifeline Risk Analysis*, Technical Report No. 82-1396-2C, Prepared for the National Science

## WATER AND SEWER LIFELINES

Foundation, J. H. Wiggins Company, Redondo Beach, CA, February 1983.

Environmental Quality Systems Inc., *Earthquake Design Criteria for Water Supply and Wastewater Systems*, Draft Report, Prepared for National Science Foundation, Grant No. AEN77-22617, August 1980.

Federal Emergency Management Agency, *Abatement of Seismic Hazards to Lifelines: An Action Plan*, FEMA 142, Aug. 1987a

Federal Emergency Management Agency, *Abatement of Seismic Hazards to Lifelines: Proceedings of a Workshop on Development of An Action Plan, Volume 1, Papers on Water and Sewer Lifelines and Special Workshop Presentations*, FEMA 135, July, 1987b

Federal Emergency Management Agency, *Earthquake Hazard Mitigation for Utility Lifeline Systems*, Student Manual, not dated.

Harding Lawson Associates, Dames & Moore, Kennedy/Jenks/Chilton, EQE Engineering, *Liquefaction Study, Marina District, San Francisco, California*, Final Report, July 1991.

Institute of Electrical and Electronic Engineers, *IEEE Recommended Practice for Seismic Qualification of Class 1E Equipment for Nuclear Power Generating Stations*, IEEE Std 344-1987.

International City Management Association, ICMA, *Emergency Management: Principals and Practice for Local Government*, ICMA, Washington, D.C. 1991.

International Conference of Building Officials, *Uniform Building Code*, Whittier, CA, 1988.

Japan Society of Civil Engineers, Earthquake Engineering Committee, *Earthquake Resistant Design for Civil Engineering Structures in Japan*, Tokyo, Japan, 1988.

Kennedy/Jenks/Chilton, *1989 Loma Prieta Earthquake Damage Evaluation of Water and Wastewater Treatment Facility Nonstructural Tank Elements*, Report No. 896086.00, Prepared for the National Science Foundation, December 1990c.

Kennedy/Jenks/Chilton, *Earthquake Loss Estimation of the Portland, Oregon Water and Sewage Systems - Evaluation of Concentrated Facilities*, Report No. K/J/C 896015.00, 1990a.

Kennedy/Jenks/Chilton in Association with Dames & Moore, *Earthquake Loss Estimation for the City of Everett, Washington's Lifelines*, Report No. K/J/C 906014.00, May 1991.

Kennedy/Jenks/Chilton in Association with Dames & Moore, *Earthquake Loss Estimation Modeling of the Seattle Water System*, Report No. K/J/C 886005.00, October 1990b.

Kubota, Limited, *Earthquake-Proof Design of Buried Pipelines*, October 1981.

Manufacturers Standardization Society of the Valve and Fittings Industry, Inc., *Pipe Hangers and Supports - Materials, Design and Manufacture*, ANSI/MSS SP-58, 1975; *Pipe Hangers and Supports - Fabrication and Installation Practices*, MSS SP-89, 1978, *Pipe Hangers and Supports - Selection and Application*, ANSI/MSS SP-69, 1976.

## RECOMMENDATIONS FOR LIFELINE SEISMIC STANDARDS

National Fire Protection Association, NFPA No. 13, *Installation of Sprinkler Systems*, Quincy, MA, 1989.

National Research Council (NRC), Panel on Earthquake Loss Estimation Methodology, Committee on Earthquake Engineering, Commission on Engineering and Technical Systems, *Estimating Losses From Future Earthquakes*, Washington, D.C., 1989.

National Research Council, Committee on Safety Criteria for Dams, Water Science and Technology Board, Commission on Engineering and Technical Systems, *Safety of Dams, Flood and Earthquake Criteria*, National Academy Press, Washington D.C., 1985.

National Research Council, Committee on Safety of Existing Dams, Water Science and Technology Board, Commission on Engineering and Technical Systems, *Safety of Existing Dams, Evaluation and Improvement*, National Academy Press, Washington D.C., 1983.

NIBS Report to FEMA, *Strategies and Approaches for Implementing A Comprehensive Program to Mitigate the Risk to Lifeline from Earthquakes and Other Natural Hazards*, Ad Hoc Panel on Lifelines, 1989.

NOAA/EERI, *San Fernando, California, Earthquake of February 9, 1971*, U.S. Department of Commerce, Washington, D.C. 1973.

O'Rourke, Michael and Ayala, Gustavo, "Pipeline Damage Due to Wave Propagation," *Journal of Geotechnical Engineering*, in preparation.

Shinozuka, M; Tan, R. Y.; Koike, T; "Serviceability of Water Transmission Systems under Seismic Risk," *Lifeline Earthquake Engineering*, p. 97-126, American Society of Civil Engineers, New York, 1981.

Southern Building Code Congress, *Standard Building Code*, Birmingham, Alabama.

Trautmann, C. H.; O'Rourke, T. D.; Grigoriu, M.; Khater, M. M.; "Systems Model for Water Supply Following Earthquakes," *Lifeline Seismic Risk Analysis - Case Studies*, p. 30-50, American Society of Civil Engineers, New York, 1986.

United States Committee on Large Dams, USCOLD, *Guidelines for Selecting Seismic Parameters for Dam Projects*, USCOLD, c/o Chas T. Main, Inc., Boston Massachusetts, October, 1985.

United States Department of Interior, Bureau of Reclamation, *Design of Small Dams*, Third Edition, 1987.

URS Corporation, *Seismic Evaluation of Steel Water Storage Facilities*, Vol. 1 and 2, Final Report, Prepared for City of Portland, Oregon, Bureau of Water Works, Portland, Oregon, May 1987.

Wang, Leon; Wang, Joyce; Ishabashi, Isao; Ballantyne, Donald; and Elliott, William; *Development of Inventory and Seismic Loss Estimation Model for Portland, Oregon Water and Sewer Systems*, Technical Report No. ODU LEE-6 in Lifeline Earthquake Engineering Research Series, Prepared for the Dept. of Interior, U.S. Geological Survey, Grant Award 14-08-0001-61694, Department of Civil Engineering, Old Dominion University, Norfolk, Virginia, April

1990.

Water Pollution Control Federation and ASCE, *Wastewater Treatment Plant Design*, American Society of Civil Engineers, New York, 1991.

*RECOMMENDATIONS FOR LIFELINE SEISMIC STANDARDS*

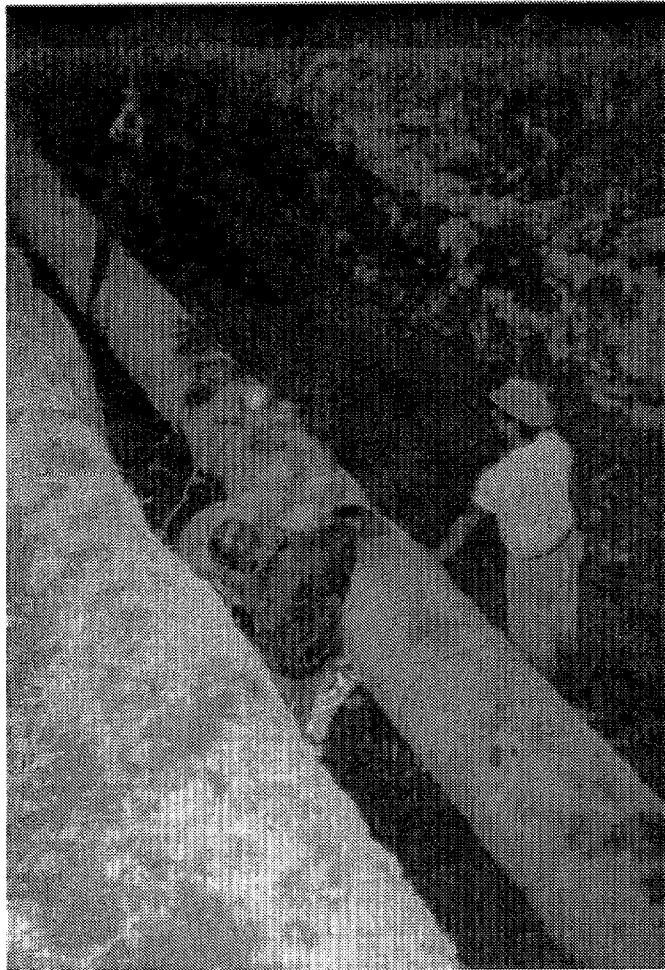


Figure 1. Typical pipeline earthquake failure repair.



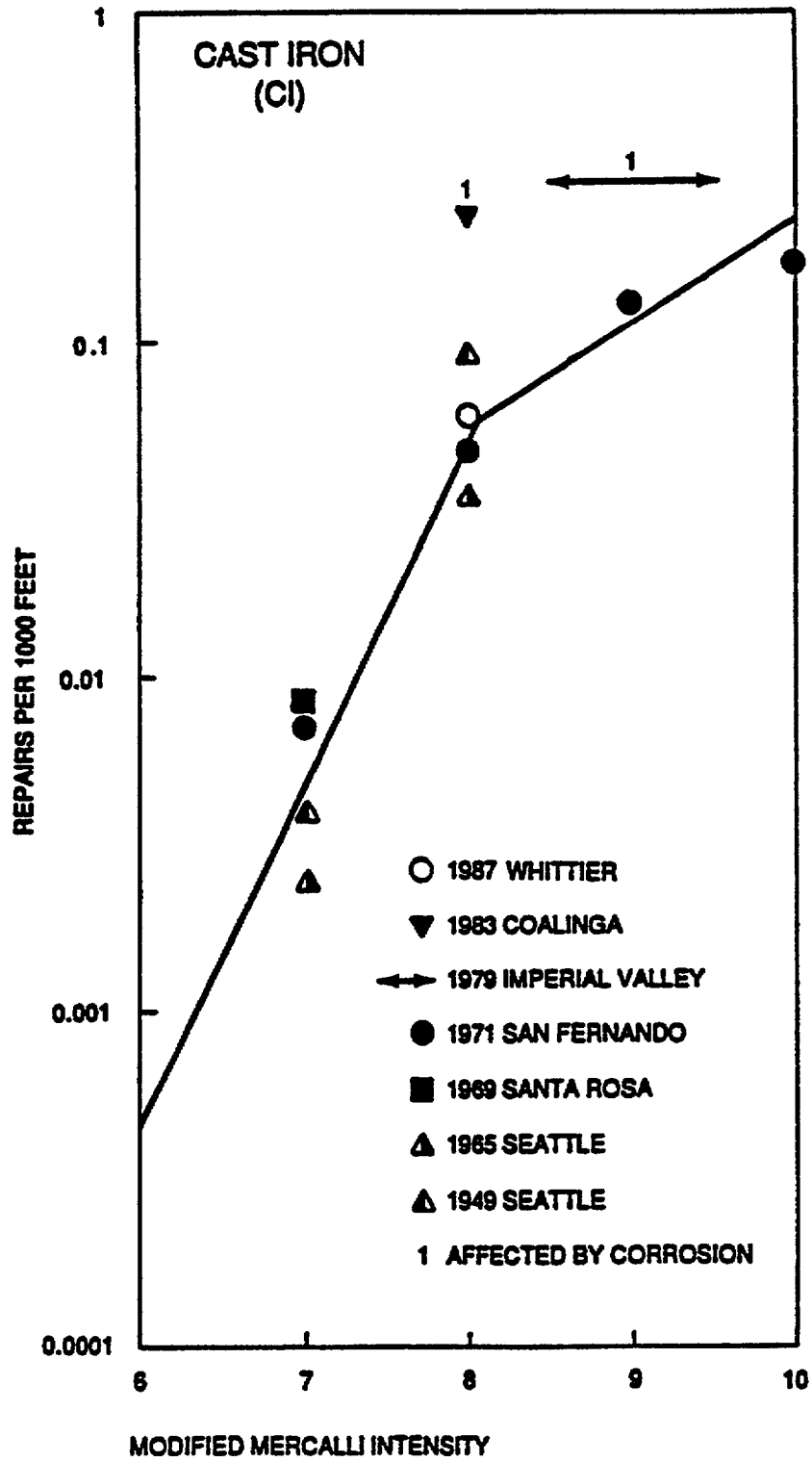


Figure 2. Damage algorithm for cast iron pipe.

RECOMMENDATIONS FOR LIFELINE SEISMIC STANDARDS

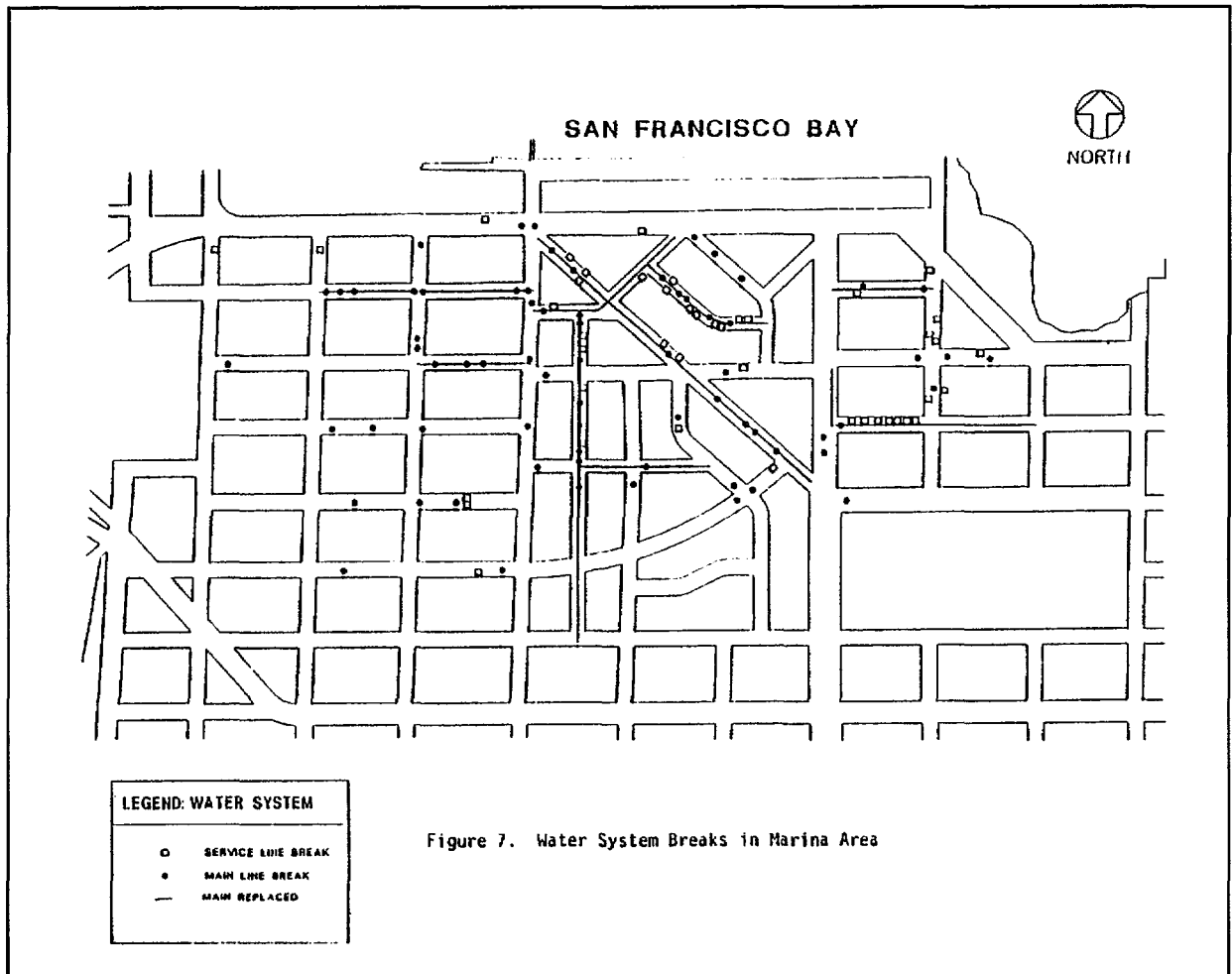


Figure 3. Water main failures in the San Francisco Marina District resulting from the Loma Prieta Earthquake.

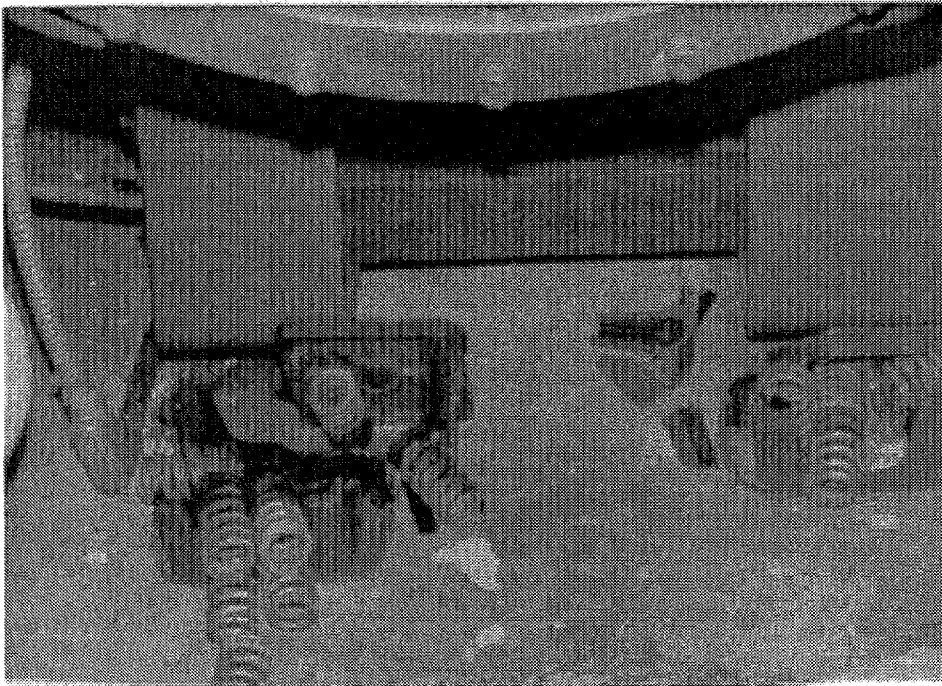


Figure 4. Spring vibration isolator on an engine-generator set, damaged in an earthquake.

*RECOMMENDATIONS FOR LIFELINE SEISMIC STANDARDS*

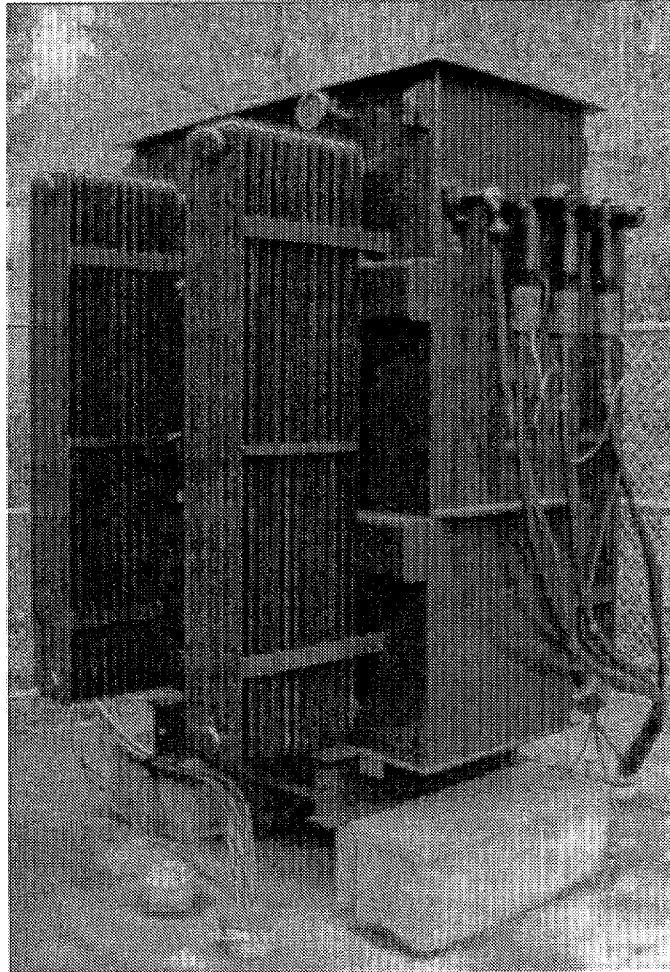


Figure 5. Precariously mounted electrical power transformer serving an 80 million per day sewage pump station, very vulnerable to earthquakes.

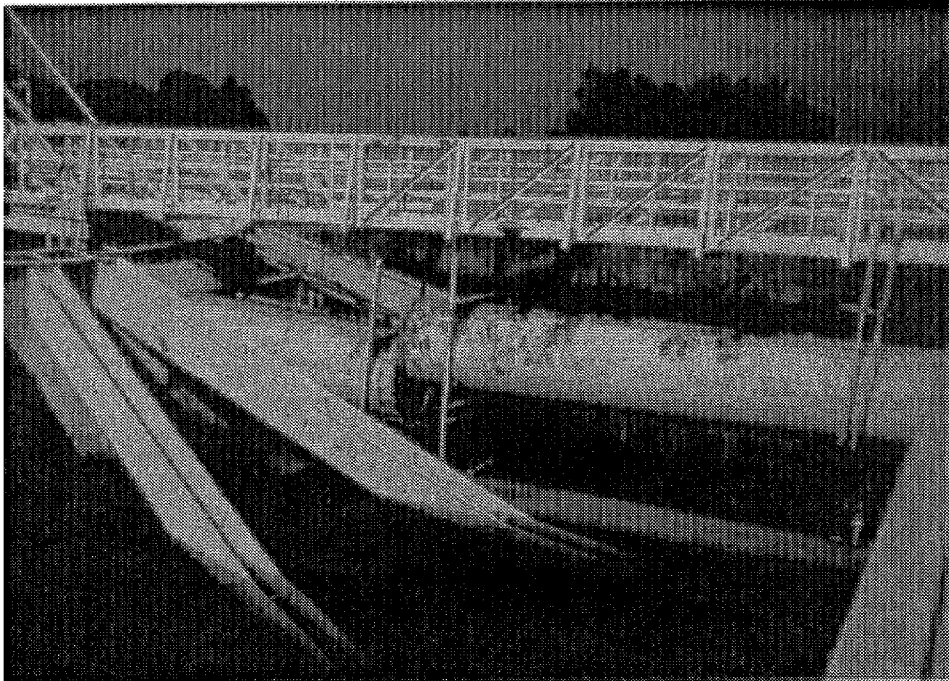


Figure 6. Sloshing damage to a clarifier at the Rinconada Water Treatment Plant resulting from the Loma Prieta Earthquake.

*RECOMMENDATIONS FOR LIFELINE SEISMIC STANDARDS*

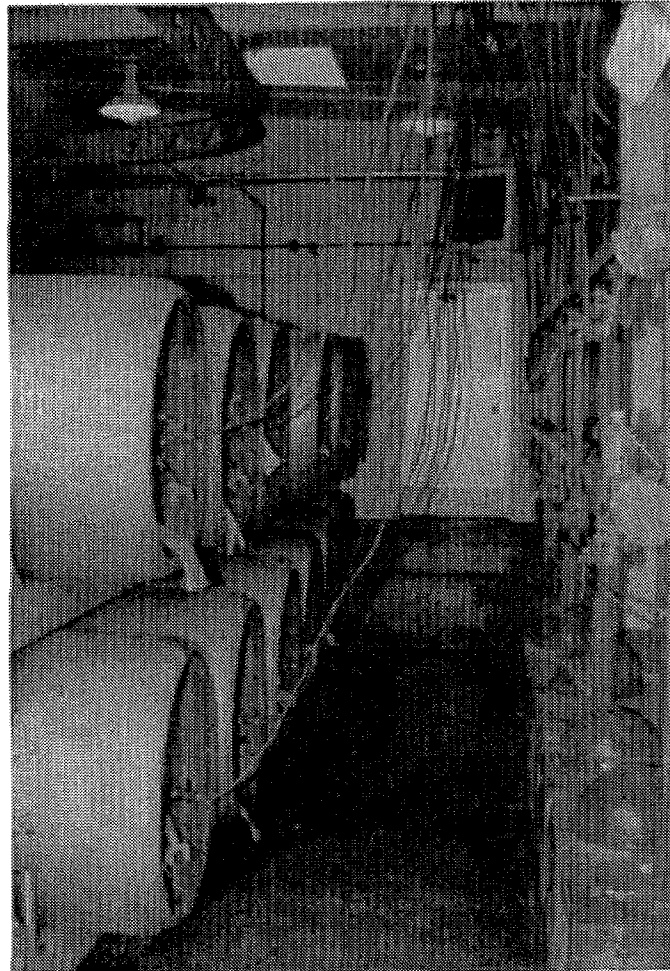


Figure 7. Vulnerable chlorine container installation.

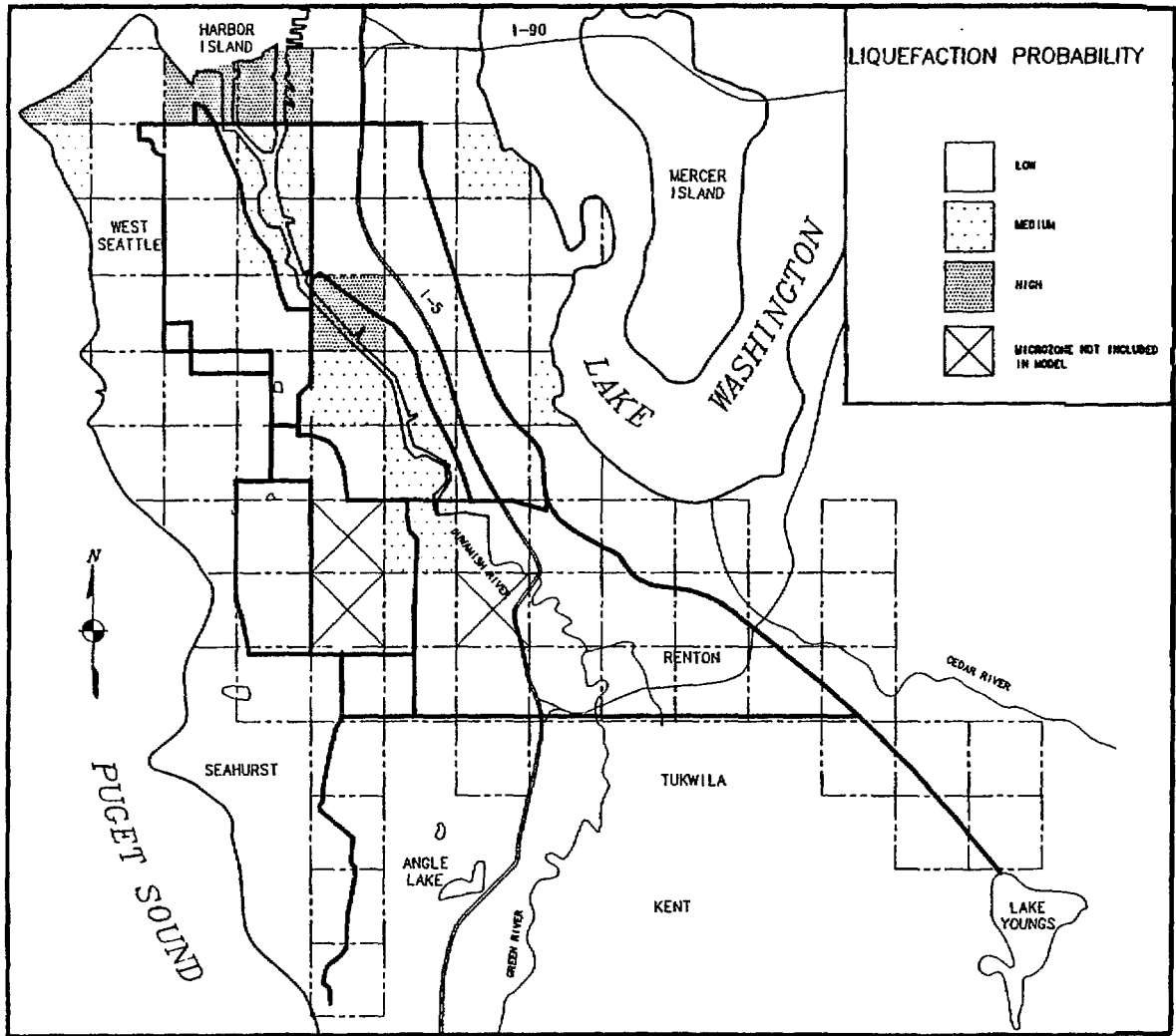
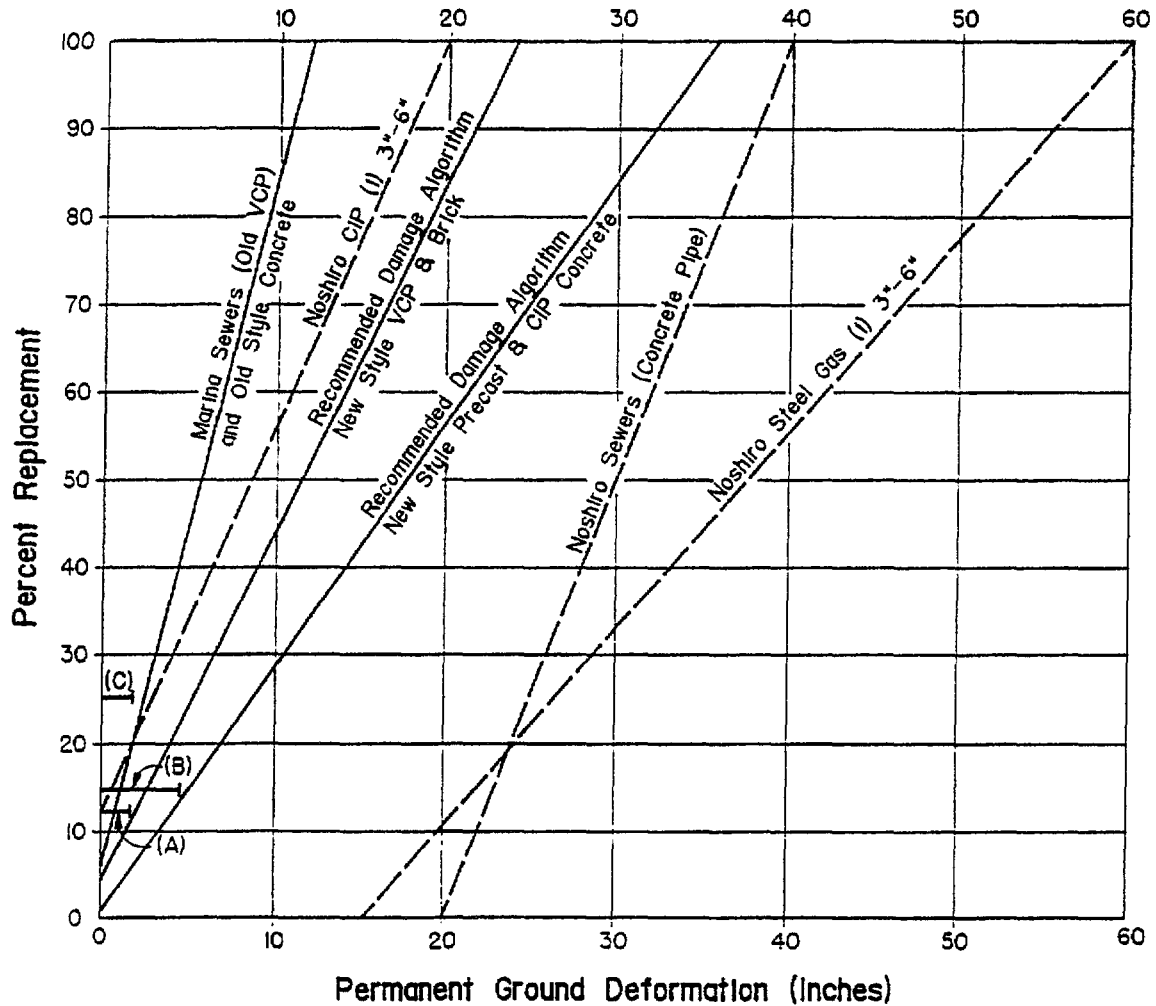


Figure 8. Liquefaction microzonation mapping for a portion of Seattle.

RECOMMENDATIONS FOR LIFELINE SEISMIC STANDARDS



Notes:

1. Assumption - 1 break = 100' pipe replacement as used by S.F. Clean Water Program.
- A. Santa Cruz Old VCP - Necessary Replacement
- B. Eguchi - AC, Concrete Liquefaction Damage (Note 1)
- C. Santa Cruz Old VCP - Convenient Replacement

Figure 9. Damage algorithm for sewers subjected to permanent ground deformation.



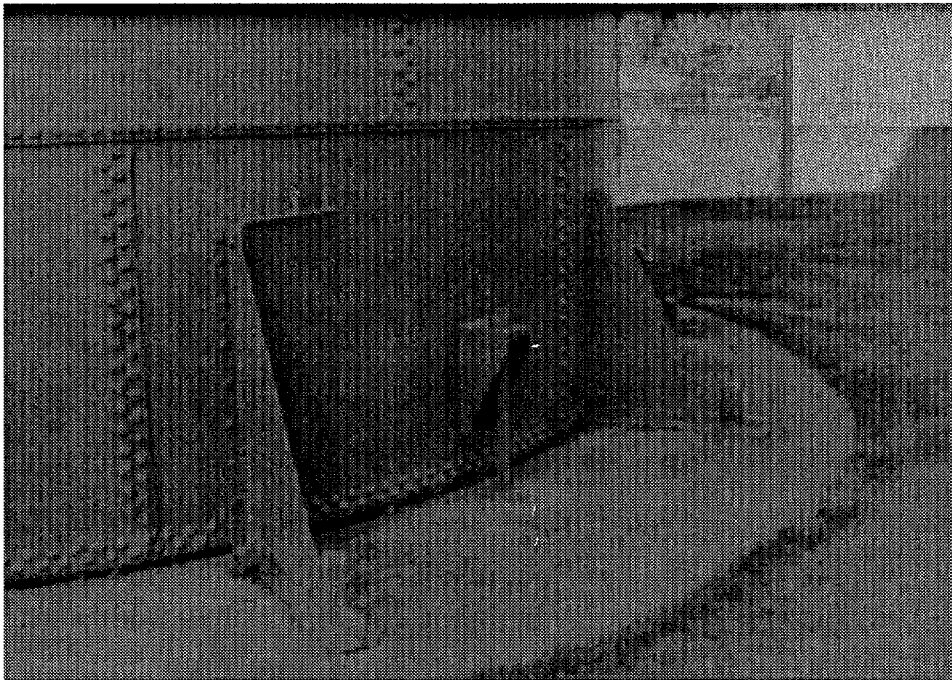


Figure 10. Seismic upgrade to a standpipe.

RECOMMENDATIONS FOR LIFELINE SEISMIC STANDARDS

Element/ Priority	Program Year							
	1	2	3	4	5	6	7	8
<b>1 – Policy</b>								
Policy Statement	■	■	■					
Application				■	■			
Approval					■	■		
Training					■	■	■	
<b>2 – System Plan Guideline</b>	■	■	■					
R & D Priority 1	■	■	■					
R & D Priority 2			■	■	■			
R & D Priority 3					■	■	■	
Application				■	■			
Approval					■	■		
Training					■	■	■	
<b>3 – Component Priority 1</b>	■	■	■	■				
Training					■	■	■	
Priority 2			■	■	■	■		
Priority 3					■	■	■	■
<b>4 – Equipment Priority 1</b>	■	■	■	■				
Priority 2			■	■	■	■		
Priority 3					■	■	■	■
<b>5 – Emergency Planning Guideline Development</b>	■	■	■	■				
Training					■	■	■	
Implementation Study			■	■				

Figure 11. Water and sewer program schedule.

---

## CHAPTER VII: FEDERAL ROLES IN DEVELOPMENT, ADOPTION, AND IMPLEMENTATION OF SEISMIC DESIGN STANDARDS FOR LIFELINES

*H. CRANE MILLER*

---

### VII-1. INTRODUCTION

Complex networks of infrastructure are the woof and warp by which our society and our economy are supported. In a very real sense they are lifelines, basic to the operation and well-being of our communities, supplying energy, water, transportation, communications, and disposal of wastes. So often taken for granted, not until some event interrupts their function do we see how dependent we are on their ready availability and how interdependent their functions are.

No coherent national program or policy exists to develop seismic design standards for lifelines, much less to adopt and implement them. But for two Federal agencies included in this chapter, seismic design standards have been left to the States. Of those, California has taken by far the most action. The pattern of Federal regulation in this area reflects diverse congressional committee and executive agency jurisdiction, different constituencies and practices, and divergent perceptions of the priority to be given earthquake risks in competition with other pressing social, economic, and political needs.

In reauthorizing the National Earthquake Hazards Reduction Program Reauthorization Act, Congress directed that a plan for developing and adopting seismic design and construction standards for lifelines include "recommendations of ways Federal regulatory authority could be used to expedite the implementation of such standards."<sup>1</sup> Implicit in the phrase "implementation of such standards" are development and adoption of such standards before implementation. Questions and policy issues inherent in development of seismic design standards for lifelines are significantly different from the Federal adoption and implementation of those standards. This chapter first addresses Federal roles in the development of the standards and, second, addresses questions related to their adoption and implementation.

Federal statutory and regulatory authorities for the lifelines were surveyed. The survey is appended to this chapter as Appendix A. It consists of a brief narrative description of Federal regulatory activity for each lifeline included in this report, Senate and House authorizing committees and their subcommittees, and cites principal Federal legislative and regulatory authorities for each lifeline. It also cites design standards used by design professionals and others, some of which contain seismic criteria. Whether they contain seismic design criteria at present, in many instances these are the standards that would be amended if seismic design standards were to be developed under this plan.

Each lifeline included in this report is regulated in some manner by a Federal agency. However, current Federal policy and regulatory practice provide uneven direction regarding seismic design standards and different means for implementing whatever regulations do exist. Most of the agencies reviewed have no seismic design regulations for their lifelines, except as they may require that buildings housing the facilities comply with the Uniform Building Code or applicable State or local construction codes and standards (e.g., EPA for water and sewer facilities, FCC for

## RECOMMENDATIONS FOR LIFELINE SEISMIC STANDARDS

telecommunications, FERC for electrical power, FRA and UMTA for heavy and light rail, and FAA for airports). Of those reviewed, only the Federal Highway Administration and the Office of Pipeline Safety have adopted seismic design standards.

The existing framework of Federal regulation of lifelines includes:

- Direct Federal ownership and operation of lifelines
- Financing, grants-in-aid
- Contracts for facilities and services
- Licensing, permitting, and rate-making
- Disaster assistance

Seismic design is not the primary focus of any of the Federal lifeline regulatory efforts. Where Federal agencies use seismic design standards, the standards make sound economic, social and political sense, and the agencies usually ground them in their adverse earthquake experience.

Other forms of nonregulatory Federal activity, typified by the National Earthquake Hazards Reduction Program, include conducting or sponsoring research; studies on earthquake hazards, seismic design standards, and studies on legal, social, economic and political impacts; technical assistance; education and training.

Section 1 of this chapter addresses development of seismic design standards; Section 2 treats issues that must be considered to speed adoption and implementation of design standards.

### VII-2. DEVELOPMENT OF DESIGN STANDARDS

#### VII-2.1 Sources Of Standards

When applied to lifelines, standards in the general sense of rules for an orderly approach to a specific activity can be:

- Site specific--Developed for the project by the design professional
- Proprietary--Developed and owned by the standard developer for its internal business use and not available to the public or to competitors
- Voluntary consensus standards--Developed by representatives of sectors with interests affected by the standards
- Governmental--Prepared by military agencies, the General Services Administration for Federal procurement, or by other Federal agencies for their regulatory purposes

Examples include site specific standards for tunnels; proprietary standards of telecommunication companies; voluntary consensus standards approved by the American National Standards Institute (ANSI), standards of the American Society of Civil Engineers (ASCE), and of the American Society for Testing and Materials (ASTM); and military technical manuals for seismic design of buildings.

There are an estimated 275 organizations with ongoing standardization programs, according to the National Institute of Standards and Technology (NIST).<sup>2</sup> NIST further estimates that about

94,000 U.S. standards have been developed, about 52,500 (55 percent) by the Federal Government, and about 41,500 (45 percent) by the private sector. (See Table 1.) The standards of greatest concern in this chapter are generally found among those of the scientific and professional societies and standards development organizations.

### VII-2.2 Federal Policy Toward Standards

OMB Circular A-119, October 26, 1982, states that it is the policy of the Federal Government in its procurement and regulatory activities to:

[6.] a. Rely on voluntary standards, both domestic and international, whenever feasible and consistent with law and regulation pursuant to law; . . .<sup>3</sup>

The circular states that voluntary standards that are consistent with applicable laws and regulations should be adopted and used by Federal agencies unless they are specifically prohibited by law from doing so, and should be given preference over nonmandatory government standards unless use of such voluntary standards would adversely affect performance or cost, or have other significant disadvantages. Preference should be given to those standards based on performance criteria when such criteria may reasonably be used instead of design, material, or construction criteria. Agencies should not be inhibited, if within their statutory authorities, from developing and using government standards in the event that voluntary standards bodies cannot or do not develop a needed, acceptable standard in a timely fashion.<sup>4</sup>

Consistent with Circular No. A-119, the Federal Highway Administration's Design Standard for Highways incorporates AASHTO's *Guide Specifications for Seismic Design of Highway Bridges*, and presumably will amend its regulations to incorporate AASHTO's upgrading of the guide specifications to standard specifications. In similar fashion, the Office of Pipeline Safety incorporates by reference API Standard 650, *Welded Steel Tanks for Oil Storage*, which contains seismic design requirements in one of its appendices.

Incorporation of voluntary standards by reference is common practice, but Federal lifeline agencies have not used the practice extensively for seismic design standards.

### VII-2.3 Need For Seismic Design Standards

Each of the technical lifeline components of this plan makes a strong case for the vulnerability of the lifeline to seismic hazards. Given the extent and complexity of the systems involved, each makes a strong case for lifeline design standards that provide a consistent level of seismic resistance and performance throughout the nation, consistent with varying earthquake and other natural hazards in different regions.

Why a Federal role in developing seismic design standards for lifelines? When the risks of and vulnerability to damages from earthquakes from all areas of the country are added together, the Federal Government has more potential exposure than any other single unit of government. That exposure includes direct Federal ownership and operation of lifelines; financing, grants-in-aid; contracts for facilities and services; licensing, permitting, and rate-making; and disaster assistance.

Much of the potential damage is preventable by relatively inexpensive means. Seismic design standards are one of the means through which future damages could be reduced if they were developed, adopted, and applied. However, no other single body of government has as much at stake as the Federal Government to reduce damages from earthquakes. No other governmental

## RECOMMENDATIONS FOR LIFELINE SEISMIC STANDARDS

body has as much incentive to foster consistent standards on a national basis.

If the various lifeline areas were to move wholly by voluntary consensus, without the catalytic encouragement, financial assistance, and nudging of the Federal Government, the process would take decades and the results would be uneven. If action is to take place to develop seismic design standards for lifelines, it is recommended that they be developed under the sponsorship and aegis of the Federal Government, but to the greatest extent feasible by voluntary consensus.

It is recommended that the Federal Government's role in the *development* of lifeline seismic design standards be *catalytic, facilitating and encouraging* development of seismic standards for all lifelines *concurrently*. To do so does not require Federal regulatory action, but does require congressional authorization and appropriations and the use of Federal contracting authority. If the Congress and the Executive Branch were to so act, the results would be more consistent, more even, and more timely than could be achieved otherwise.

### **VII-2.4 Recommended Plan To Develop Seismic Design Standards For Lifelines**

Recommendations are as follows:

1. In order to expedite development of lifeline seismic design standards, the Congress amend the National Earthquake Hazards Reduction Act of 1977 to create a program to facilitate development of seismic design standards for lifelines, under the direction of the National Institute of Standards and Technology (NIST).

This recommendation is consistent with NIST's mandate to improve codes, standards, and practices for structures and lifelines, and further consistent with the memorandum of understanding between FEMA and NIST that NIST have the lead responsibility in development of lifeline seismic design standards.

2. The Congress authorize NIST to enter into contracts with organizations and expert consultants to develop draft seismic standards in each of the lifeline areas.

This recommendation emphasizes the catalytic, facilitating role envisioned for the Federal Government in the development of the lifeline seismic design standards. NIST would turn to standards and other interested organizations, and to expert consultants within each lifeline area, for the draft standards.

3. The Congress authorize and direct all Federal agencies having jurisdiction over lifelines included in the program to cooperate with appropriate organizations in the development of the seismic design standards, and to review and comment upon drafts of standards for the lifelines under their jurisdiction.

Neither NIST nor any other Federal agency would be responsible to develop lifeline seismic design standards. But each appropriate agency should be authorized and directed to cooperate in the standards development process, and to review and comment upon drafts as they progress. Once voluntary consensus is reached, government agencies should independently review the standards for adoption and implementation into their programs.

## FEDERAL ROLES

4. Consistent with congressional purposes to save lives, protect property, and to ensure the continued functioning of lifelines after moderate and major earthquakes, the authorizing legislation state only the broadest of guiding principles, leaving to the standards development and consensus process the standards to be developed.
5. The Congress authorize and appropriate funds adequate to support the development of lifeline seismic design standards and to support research and development necessary to improve the standards continuously over time.
6. That NIST create an "umbrella" lifelines seismic standards group to monitor and coordinate the voluntary consensus process.

Constituent members of the group should be involved from the initial stage of design standards development. Continuing support should be provided for the group.

7. As a guideline, draft lifeline seismic design standards should be completed within three years, followed by two years for trial designs (including case studies of effective system and component practices), and two years for the consensus process.

Recognizing that this recommendation may require variations among different lifelines, time limits should be set for drafting the standards, conducting trial designs and comparing estimated costs under both old and proposed new standards, and separately undertaking and completing the consensus process.

8. Draft standards include both component standards and system performance requirements, and consider interdependence with other lifelines.

Design standards typically address components alone, and not the entire system nor the system's interaction and interdependence with other lifelines. This recommendation calls for lifeline seismic design standards to be considered in a more complete context than is usual.

9. Draft standards take into account different levels of seismic and other natural hazards risk to the different lifeline systems in different parts of the country.

Factors to be considered include region, risk characteristics, interdependencies, different priorities in various regions, and different-sized providers of lifeline services.

The recommended program to develop lifeline seismic design standards will provide a number of benefits. It will facilitate:

- The nongovernmental standard setting process, providing incentives by funding part of the costs while requiring no Federal regulatory intervention
- Voluntary adoption of seismic standards by standard-making organizations and

## RECOMMENDATIONS FOR LIFELINE SEISMIC STANDARDS

lifeline facility operators

- Adoption and implementation by Federal agencies that own or have operational responsibility for certain lifeline facilities
- Adoption and implementation by other Federal agencies through incorporation into regulations, financing, contracts, grants-in-aid, licensing, and disaster assistance

### **VII-3. ADOPTION AND IMPLEMENTATION OF LIFELINE SEISMIC DESIGN STANDARDS**

In order to move to adoption and implementation of lifeline seismic design standards we assume that voluntary consensus standards have been developed. Ideally, the standards would be voluntarily adopted and implemented in all private and governmental sectors involved, without further regulatory or other Federal intervention. That ideal is unrealistic. Experience shows that a number of formidable barriers exist to adoption and implementation. Political, economic, social, and legal pressure will most likely have to be brought to bear in certain lifeline sectors. What those pressures would be cannot be determined until the standards are developed and experience gained in their adoption and implementation.

Some existing factors in Federal lifeline regulation, and issues that must be considered to speed implementation of design standards are included in this part. They include political and social, economic, and regulatory contexts.

#### **VII-3.1 Implementation--A Political And Social Context**

##### **VII-3.1.1 Low Priority Of Seismic Risk**

Seismic risk competes with other pressing social, economic, and political issues. Most surveys of State and community leaders to date show that seismic risks do not rank high on the lists of things they worry about. A survey conducted by Rossi, Wright and Weber-Burdin<sup>5</sup> of 2,300 political decision-makers in 20 States and 100 localities asked leaders about 18 different problem areas. Earthquakes ranked last, 18th, with 95 percent rating earthquakes "no problem at all in this State or community." Earthquakes ranked 13th in California, 15th in Utah; and in six States considered to have "moderate to high" risk, earthquakes ranked last or second to last. They concluded that, on average, floods, hurricanes, tornadoes, and earthquakes rank low in comparison to other "more serious" problems, e.g., inflation, welfare costs, unemployment, crime, and drug addiction.

Conclusions drawn from Rossi et al. imply that States and localities that rank natural hazards high in salience or importance would generally be supporters of mitigative measures. Applying different analytical techniques to the survey data collected by Rossi, Wright and Weber-Burdin, Mittler<sup>6</sup> found that the salience or prominence of natural hazard problems was *not* a good indicator of support for mitigative measures. Mittler's study indicated that State and community leaders "will support nonstructural hazard mitigation if they believe a problem is serious enough to warrant such action."<sup>7</sup> Some threshold must be achieved to convince leaders that a perceived risk is sufficient to justify taking mitigative action. Unfortunately, Mittler wrote, data do not point conclusively to factors that would motivate action.<sup>8</sup>

Drawing from data derived from a study of 1,503 local decision-makers in 6 States and 121 cities in moderate to high risk areas in the central United States, Nigg<sup>9</sup> found low levels of knowledge, experience, or concern among 67 public works directors and 48 utility company managers



surveyed. While managers of lifeline systems in higher risk areas were more aware of and concerned about earthquake threats, Nigg's survey found that awareness and concern "were *not* translated into action."<sup>10</sup>

Turner et al.,<sup>11</sup> the Association of Bay Area Governments,<sup>12</sup> and others have written that experience with a damaging earthquake is one major factor influencing concern for and awareness of earthquake hazards. Nigg's survey showed low levels of individual experience with earthquakes among the public works directors and utilities managers interviewed.<sup>13</sup> Note that all surveys cited were conducted before the Loma Prieta earthquake in 1989. The people and leaders of California have now experienced that earthquake. They have heightened awareness and concern about seismic risks, and may have moved earthquakes up from their relatively low ranking since that event.

Wright (1980)<sup>14</sup> offered another related interpretation that may help in understanding why apparent awareness and concern about earthquake risks are not translated into action. Wright inferred from his work that most innovations in natural hazards management originate at the State and Federal levels, the direct result of the aggregation of natural hazards probabilities. Using Wright's reasoning, the probability of a damaging earthquake in any one community is significantly lower than the number that may occur in the State after aggregating the probabilities of the State's communities; the national probabilities are the aggregate of the States, therefore greater than any one State. The need for action is greater at the national level than at the State level, greater at the State level than at the local.

Whether the larger probabilities for the State and the Nation translate into action is an open question. California, faced with the highest seismic risks among the 48 conterminous States, has enacted and imposed more stringent, preventive seismic measures than any other State, and, in most instances, more than the Federal Government. A question remains, what action should the remaining States and the Federal Government take?

### **VII-3.1.2 Federal Perceptions Of Seismic Risk**

The perception that earthquakes and other natural hazards rank low on political priorities and agendas applies at the Federal level as well as the State and local level. First, seismic risks are not the *primary* focus of executive or legislative concern for any of the Federal agencies or congressional committees having jurisdiction over lifelines. Secondly, seismic risks compete with economic recession, inflation, unemployment, the Federal deficit, drug abuse and crime, and other economic, political and social agendas for the limited resources available. The Federal budget does not have a great deal of flexibility. A high percentage of any year's budget is fixed and committed to pay existing Federal indebtedness and to make other payments fixed by law. Any payment of extraordinary expense must be met by increased deficit spending, increased taxes, or reduced spending in some other sector of the economy.

While there is an emerging awareness and concern about earthquake risks, those nascent perceptions have not translated into consistent policy and action by the agencies responsible for various lifelines. Federal disaster management policy continues to be focused primarily upon corrective action after a disaster occurs and less upon preventive measures before a disaster.

Intuitively we expect that economically feasible mitigative measures taken to reduce loss of life and damages before a disaster will reduce those losses when the disaster occurs. And intuitively we know that there are optimal points where the costs to prevent or reduce damage *before* a disaster, especially those to retrofit existing facilities, exceed the costs to correct, repair, or replace *after* a disaster. One purpose of mitigative measures, including seismic design standards,

## RECOMMENDATIONS FOR LIFELINE SEISMIC STANDARDS

is to increase benefits to an optimal point beyond which the costs exceed the benefits, and it is no longer economically beneficial or feasible to reduce damage. Unfortunately, little work has been done to provide management decision models to help make such choices for lifelines.

### VII-3.2 Implementation--An Economic Context

Since the United States has emerged as a large, advanced, integrated economy it has never experienced a great earthquake in a large metropolitan area.<sup>15</sup> Earthquakes of the last 20 years, e.g., Loma Prieta (1989), Whittier Narrows (1987), San Fernando (1971), have caused loss of life, billions of dollars of damages, and had drastic impacts upon certain families, districts within localities, and upon certain economic sectors. But in a macroeconomic sense they have been "affordable," followed by local short-term disruption and swift recovery at the county, regional, and State levels, and barely noticeable at the national level. In the context of California the economy has proven to be more resilient than many had predicted.

That resilience is explained partly by the high integration, flexibility, and substitutability found in the economy. Substitutes for the regions' products were available or producible outside the regions. Economic shocks of the disasters were spread widely to other regions, to other time periods, and risks were spread through trade, insurance, credit, and diversity of ownership. The institutions and mechanisms within our economy for spreading the economic shocks are vastly different from those that existed at the time of the Great San Francisco Earthquake of 1906, or the stock market crash of 1929.

Based upon "moderate" earthquakes and the California experience, some economists conclude that the long-term adverse impacts to the economy is small. Indeed, the need for reconstruction, and the infusion of credit, savings, insurance payments, disaster assistance payments, and new capital investment by outside investors, will probably lead to new prosperity for localities and regions whose economies were vital and growing before the earthquake. But where the economies were declining before the earthquake for other reasons, the earthquake may accelerate that decline.

With a gross national product over \$5 trillion and a national equity market valued over \$2 trillion, a \$10 billion loss from an earthquake disaster may produce a change of 1/2 of 1 percent in the capitalized value of corporate America. Our economic resilience is keyed to the size and diversity of our economy, to the scope of substitution in production, consumption and investment, quickly dampening any ripple effect of a disaster through the economy.

But what if the losses from a great earthquake were ten times those experienced in Loma Prieta, say on the order of \$75 to \$100 billion? Is a loss that might produce a change of 5 percent in the capitalized value of corporate America still small? Some argue that large though the amounts are, they still suggest a relatively small impact upon the national economy because of the high integration and ability to substitute. There will be ripple effects through the economy, the recovery will be slower than is experienced with smaller disasters, but the economic shocks will be dispersed efficiently through a wide variety of institutions and mechanisms.

Seen from the perspective of the insurance industry, or from the State Government called upon to provide cash for disaster assistance when its general fund is already highly committed by law and constitution, the response to a great earthquake is quite different. In both instances the immediate concern is their ability to raise money quickly to pay claims and to provide disaster assistance. A large disaster could cause insolvencies among many insurance companies, and could sharply decrease industry capital reserves. With 82 percent of its General Fund expenditures fixed by law and the State constitution, California has high and continuing demand on its financial

resources, and may lack flexibility to redirect funds after an earthquake. Political choices among curtailed expenditures, increased taxes, or redirection of funds are particularly vexing after a natural disaster.

For both the insurance industry and State Government the amount of money needed and when it is needed affect the ways funds can be raised and the speed with which the recovery will take place. The speed of recovery will affect secondary losses. And if physical losses are reduced through mitigation actions before the earthquake, the recovery will be faster and primary and secondary losses will be reduced.

The irony of lifelines in our economy may be that as the economy has become more diverse, more integrated, with higher levels of substitutability, some of our lifelines have become more concentrated and have fewer substitutes. This suggests greater dependence and higher vulnerability than in other areas of the economy. The impact of disrupting their services is likely to be higher than for other services and products.

Why consider Federal regulation of seismic design for lifelines? At least three reasons are readily evident. First, through its disaster assistance programs, the Federal Government has a large unfunded, contingent liability for lifelines and incentive thereby to reduce the damages that cause the liability. Second, earthquakes cause direct property losses and indirect losses of forgone economic activity that radiate through the local, regional and national economy. Third, economic activity, health, safety and welfare at all levels of our society are dependent and interdependent on lifelines for their functioning.

### VII-3.2.1 Unfunded Contingent Liability

The Robert T. Stafford Disaster Relief and Emergency Assistance Act (1988) commits the Federal Government to large contingent liabilities after presidentially declared disasters from earthquakes or other natural disasters. At least 75 percent of the net eligible costs to repair, restore, reconstruct, or replace public and private nonprofit facilities may be contributed under §406.<sup>16</sup> "Public facilities" means facilities owned by a State or local government. They include such lifelines as public power, sewage treatment and collection, water supply and distribution, airport facilities, and non-Federal-aid streets, roads, or highways.<sup>17</sup> (Note that this definition does *not* include private for-profit utilities, such as electric power, telecommunications, or pipelines, which are included in this report).

Section 404 of the Act authorizes the President to contribute up to 50 percent of the cost of hazard mitigation measures to reduce the risk of future damage. These measures can include public and private nonprofit facilities, also commercial, industrial, and residential buildings. The Act limits contributions to 10 percent of estimated aggregate amounts of grants to be made under §406.<sup>18</sup>

To these amounts must be added the emergency funds available from the Department of Transportation for highway, bridge, and other transportation systems repairs and reconstruction, and disaster assistance from other departments and agencies made available when the President declares a disaster.

The focus of current disaster policy is to ensure and restore economic stability in regions struck by disasters. The policy commits the Federal Government to financing significant portions of the postdisaster response and recovery costs incurred by States and local governments. While that Federal assurance may act as a strong disincentive for State and local governments to engage in predisaster earthquake loss-reduction projects,<sup>19</sup> nevertheless the infusion of Federal disaster funds shortly after a major disaster is an important stimulus to the repair and rebuilding of several

## RECOMMENDATIONS FOR LIFELINE SEISMIC STANDARDS

of the lifelines. And unfunded and contingent though the liability may be, as administered disaster relief acts as a limitation of Federal liability while providing needed recovery assistance.

The technical information presented in earlier chapters indicates that for several of the lifelines relatively inexpensive retrofits are available that would add to the seismic resistance of the components and reduce damages. Implicit in that information is the realization that retrofitting existing lifelines to the latest seismic design standards for new lifelines is not economically feasible. One view of Federal disaster assistance for lifelines is that it partially pays for risk assumed and damages incurred above the level where it is economically feasible to retrofit existing lifelines. To the extent that mitigative measures could increase the threshold at which Federal disaster relief is invoked, and reduce the potential Federal liability, the Federal Government has a clear interest.

From the standpoint of federal liability, given the Stafford Act and other existing federal policies, the federal government has a clear interest in state and local programs that affect potential earthquake losses, including those pertaining to state and local development, adoption, and implementation of seismic loss-reduction measures.<sup>20</sup>

### VII-3.2.2 Direct And Indirect Losses

Earthquakes set off chains of losses through the economy. Primary, secondary, and tertiary effects radiate well beyond direct property damage. Primary or direct losses include physical loss of plant and equipment directly from the earthquake plus loss of employment associated with the plant and equipment loss. These losses may produce indirect, secondary losses, or ripple effects, which may cause loss of employment in industries that are related but physically undamaged. Other types of indirect effects include reduced household income resulting from loss of employment, bankruptcies, and bad loans.

The value of direct and indirect earthquake losses, and how to measure them are debated vigorously among economists. Some damage assessments focus on income lost, some on spending lost. A common error is to include both in the assessment, a double counting that exaggerates the loss estimates. Complicating the task even more, infusions of insurance funds, unemployment compensation, Small Business Administration loans, State and Federal aid to local governments, commercial loans, and savings, tend to mask the economic disruption resulting from the earthquake.

Until recently no uniform methods existed to guide economists and other practitioners conducting damage assessments. The recently published *Natural Hazards Damage Handbook: A Guide to the Uniform Definition, Identification and Measurement of Damages from Natural Hazard Events*<sup>21</sup> was developed under National Science Foundation sponsorship to fill that gap.

Table 2 shows that lifeline disruption profoundly affects the economics, health, safety, and welfare not only of the immediate community, but also the region, State, and the Nation.<sup>22</sup>

### VII-3.2.3 Dependence And Interdependence

As we increase our use of more advanced technology and transportation for individual and societal functioning, we are increasingly dependent and interdependent upon reliable lifeline functions--electricity, telecommunications, water and sewer, transportation. With that dependence and interdependence come a vulnerability to our daily lives and activities that extends beyond the region immediately affected by the impacts of a large earthquake.

Economic Input/Output analysis illustrates the dependence and interdependence of various sectors of the economy on lifelines and, more important, upon each other. Dr. Everard Lofting's "Preliminary Input-Output Table of the San Francisco Bay Region: 1977," presented below as Table 3, dramatically shows the dependence of each industry listed upon lifeline inputs (rows 19 - 24), and upon one another (columns 5 - 8). For instance, \$1,276,000 of transportation (row 19), \$3,682,000 of communication (row 20), \$14,393,000 of electric power (row 22), \$10,431,000 of gas (row 23), and \$462,000 of water (row 24), were inputs into water and sewer services that had a gross output of \$830,831,000 (column 8).<sup>23</sup>

On a national scale, the Applied Technology Council (ATC) recently published a study measuring the extent and distribution of lifelines in the lower 48 States, identifying the most critical lifelines in terms of their vulnerability and the impact of their disruption on the national economy.<sup>24</sup> Assessing seismic hazard, lifeline inventory, and vulnerability functions, ATC quantified vulnerability and impact of disruption in terms of direct damage and economic losses resulting from direct damage and loss of function of damaged facilities. Selecting eight "scenario" earthquakes in seven different regions of the country, the report estimated total direct damage dollar losses to lifelines as shown in Table 4.

The ATC-25 estimates appear to be conservative, that is, somewhat understated. Data on certain lifeline elements were unavailable to the researchers, e.g., telecommunications, railway terminals, bridges, tunnels, fossil-fuel power plants, and aqueduct pumping stations.<sup>25</sup> In estimating indirect economic losses, the researchers assumed that lifeline elements were independent of each other, that disruptions in one lifeline would not produce interruptions in lifeline elements.<sup>26</sup> At least to the extent that the estimates do not include losses attributable to these elements, they are understated.

The limited number of input/output analyses that have been performed for various parts of the country consistently show how important, how indispensable lifelines are to the vitality and viability of the economy, regionally and nationally. Professor Adam Rose noted that "crude application of multiplier analysis indicates that the benefits of preventing damages to lifelines may be about 2 to 2.5 times the usual direct economic estimates for a city such as San Francisco."<sup>27</sup> Equally crude application of multipliers for the regions used in ATC-25 range from 1.3 to 2.6, for an average of 2.0--consistent with the multipliers suggested by Professor Rose. National level multipliers could prove greater still.

The estimates relate only to lifelines, their direct and indirect impacts through the economy. They do not include residential, commercial, and industrial structure losses, the losses and impacts of which must be added to determine total losses. Implications drawn from these estimates include that action must be taken to protect lifelines, and that they be among the highest priority sectors restored to service after an earthquake.

### **VII-3.3 Implementation--A Regulatory Context**

#### **VII-3.3.1 Lifelines--A Regulated Environment**

**Owners And Operators**--The owners and operators of lifeline facilities are diverse, from the private and public sectors. Most electric power, gas and liquid fuel, telecommunications, and railroad facilities are privately owned and operated. State highways, bridges and tunnels, and Federal-aid highways are owned by individual States. Local governments own municipal, county, and parish roads, bridges, and tunnels. They and regional authorities tend to own and operate water and sewer, light rail/transit, airports, and ports and harbors.

## RECOMMENDATIONS FOR LIFELINE SEISMIC STANDARDS

In the midst of these facilities, and sometimes interconnected with them, are federally owned lifelines. Federal lifeline facilities represent a small percentage of the total. If a coherent Federal policy were adopted, these facilities should be among the first in which seismic design standards are implemented.

**State And Local Regulators--**Electric power, gas and liquid fuel, telecommunications, and railroad utilities tend to be regulated by State public utility commissions. State highway and transportation departments administer highways, bridges, and tunnels. Municipalities, counties, and parishes generally operate and maintain their highways, bridges, and tunnels through local public works departments. Those local governments, or authorities established to own and operate regionwide water and sewer, light rail/transit, airport, and ports and harbors facilities, tend to be self-regulators (that is, States often delegate authority to them to regulate their operations).

**Buildings And Building Codes--**Buildings are a part of each lifeline. This report does not include seismic standards for new and existing buildings; such standards have been addressed elsewhere.<sup>28</sup> Structures and foundations are regulated by local and State construction codes, including building, mechanical, electrical, and plumbing codes. States and local governments frequently adopt various editions of model codes, such as the Uniform Building Code of the International Conference of Building Officials, the (BOCA) National Building Code of the Building Officials and Code Administrators International, or the Standard Building Code of the Southern Building Code Congress International. The model code organizations publish new editions about every three years, with changes processed annually and published as supplements. New editions incorporate changes approved by the model code organization since the last edition of a given code.<sup>29</sup>

At least two considerations about buildings should be kept in mind in this report. First, the buildings housing lifeline facilities, their administrative offices, maintenance and repair, and other support facilities should be built with the same standards for function and operation after an earthquake as for the lifeline facilities themselves. Second, building code enforcement practices at the State and local levels are widely disparate, ranging from excellent and effective to nonexistent and unreliable.<sup>30</sup>

**Federal Regulators--Primary Missions--**Federal departments and agencies operate with measured authority, limited by the Constitution, their enabling legislation, and by appropriations. They answer primarily to the Executive Office of the President, to their authorizing and appropriations committees in the House and Senate, and to their constituencies.

Their primary missions differ considerably. Briefly their primary missions are:

- **Licensing, Permitting, And Rate-Making**
  1. **Department of Energy, Federal Energy Regulatory Commission.** Sets rates and charges to (1) transport and sell natural gas; (2) transmit and sell electricity; and (3) transport oil by pipeline. Licenses hydroelectric projects.
  2. **Federal Communications Commission.** Regulates interstate and foreign communications by wire and radio, including radio and television broadcasting; telephone, telegraph, and cable television operation; two-way radio and radio operators; and satellite communication.

## FEDERAL ROLES

3. **Interstate Commerce Commission.** Regulates interstate surface transportation, including railroads, and certifies carriers, rates charged, and adequacy of service.
- **Grants-In-Aid**
  1. **Department Of Transportation**
    - a. **Federal Highway Administration.** Funds Federal-Aid Highway Program; Highway Bridge Replacement and Rehabilitation Program; emergency repair or reconstruction.
    - b. **Urban Mass Transportation Administration.** Makes matching grants to finance construction and rehabilitation of public transit systems.
    - c. **Federal Aviation Administration.** Funds airport planning and development program.
- **Safety Regulations**
  1. **Department Of Transportation**
    - a. **Office of Pipeline Safety.** Regulates natural gas and hazardous liquid pipeline safety standards programs, including a program through which States can assert safety regulatory jurisdiction.
    - b. **Federal Railroad Administration.** Regulates rail safety, including track maintenance, inspection standards, equipment standards, and operating practices. Inspects railroad and related industry equipment, facilities, and records.
- **Environmental Regulations**
  1. **Environmental Protection Agency.** Regulates for water supply and water pollution control, for ground water protection, and other programs not related to seismic design for lifelines.
- **Federal Operations**
  1. **Systems Owned And Operated By Federal Government**
    - a. **Department of Energy.** Western Area Power Administration, Bonneville Power Administration, Southwestern Power Administration--transmission systems; Alaska Power Administration--power generation and transmission systems.
    - b. **Tennessee Valley Authority**
    - c. **Department of Transportation**
      1. **Federal Highway Administration.** Design and construction of roads and bridges within Federal lands.

## RECOMMENDATIONS FOR LIFELINE SEISMIC STANDARDS

2. **Federal Aviation Administration.** Constructs, owns, leases, or operates staffed and unstaffed facilities to support the National Airspace System.
2. **Transmission And Sale Of Energy**
  - a. **Department of Energy**
    1. Bonneville Power Administration
    2. Southeastern Power Administration
    3. Alaska Power Administration
    4. Southwestern Power Administration
  - **Disaster Relief**
    1. **Federal Emergency Management Agency.** Administers Federal disaster relief program for presidentially declared disaster, including funds to repair, restore, reconstruct, or replace public and private non-profit facilities owned by State or local governments. Policy to ensure and restore economic stability in regions struck by disasters.

### VII-3.3.2 Congressional Jurisdiction

Jurisdiction over lifeline systems is spread among many different authorizing committees and appropriations subcommittees of Congress, and will remain so. As the Congress moves beyond research into implementation, important new jurisdictional issues arise. In both the Senate and the House consistent, focal policy direction for *implementation* of design standards across committee jurisdictional boundaries does not exist. If Federal action is to be taken and to have any teeth, such direction is needed.

The current foci of the National Earthquake Hazards Reduction Program are on mitigation and prevention of earthquake hazards through a multiagency program of scientific research, development, and demonstration, on development of design standards, and on dissemination of the results of such work. None of the primary agencies in the Program have regulatory authority concerning seismic design standards. So focused, the Program is clearly and exclusively within the parliamentary jurisdiction of its two principal congressional authorizing committees, the Senate Committee on Commerce, Science, and Transportation and the House Committee on Science, Space, and Technology.

When the Program focus shifts to implementation, complex parliamentary issues emerge that go to the heart of the Federal Government's ability to implement design standards for lifelines consistently.

**House--**Under the Rules of the House of Representatives, each standing committee has oversight responsibilities over existing laws and new legislation within its jurisdiction.<sup>31</sup> Bills relating to committee jurisdiction are to be referred by the Speaker to the appropriate committee "in such manner as to assure to the maximum extent feasible that each committee which has jurisdiction . . . over the subject matter of any provision . . . will have responsibility for considering



such provision . . ."<sup>32</sup>

Carrying out these mandates the Speaker has several options for referring legislation simultaneously to two or more committees: concurrent consideration; consideration in sequence; divide the matter into two or more parts and refer each part to a different committee; refer the matter to a special ad hoc committee; or "make such other provision as may be considered appropriate."<sup>33</sup>

**Senate**--Subject to similar jurisdictional constraints in the Senate, the Committee on Commerce, Science, and Transportation has jurisdiction over telecommunications and several transportation lifelines. The Committee's assertion of jurisdiction is further bolstered in its having taken the Senate lead in earthquake matters since 1972.<sup>34</sup> As in the House, any attempt to legislate implementation of lifeline design standards comprehensively in a single bill probably would be referred to two or more committees.

Table 5 shows that jurisdiction over the lifelines covered in this report resides with several committees. There is a high probability that any legislation introduced to implement design standards for lifelines would be referred to two or more committees simultaneously. How that might be done would clearly constrain the strategies used in drafting and introducing legislation, and would influence the outcome of the legislative process.

### **VII-3.3.3 Uncertain Trumpet Of Federal Seismic Regulation**

Most of the pressure to innovate in earthquake risk management must be expected to emanate primarily from the Federal level, since the risks and potential liabilities are most serious when aggregated to that level. Current Federal policy tools provide no consistent, focal direction, nor means to implement widescale loss-reduction measures for buildings, and even fewer for lifelines.

Government-wide initiatives in the Executive Branch have only recently begun and are limited to new buildings.<sup>35</sup> No comparable initiatives for lifelines have emanated from the Congress or the Executive Branch. "If the trumpet give an uncertain sound, who shall prepare himself to battle?"<sup>36</sup>

Experience from other Federal programs amply shows that if the Federal Government applies consistent policy, supplies resources balanced with regulatory constraints, State and local governments follow. From a Federal perspective it is important to concentrate design standards for lifelines in State Governments and the Federal government, although the goal is effective implementation in local communities.

### **VII-3.3.4 Federal Implementation Of Lifeline Seismic Design Standards**

The previous recommendations emphasize a type of Federal-private sector "partnership" to develop lifeline seismic design standards--the Federal Government facilitates seismic design standards by the private sector through funding, coordinating, and monitoring concurrent development in each of the lifeline areas. Development of the standards would not and should not imply that the Federal Government must adopt and implement them.

Nevertheless, in keeping with Federal policy enunciated in OMB Circular A-119 as well as the spirit of this proposed program, Federal agencies would be expected to adopt the lifeline design standards unless the standards were prohibited by law, would adversely affect performance or cost or otherwise have significant disadvantages, or were not stringent enough to meet special agency missions. Much remains to be done before specific implementation programs can be recommended. Thus we recommend a process to study and plan implementation strategies for lifeline seismic design standards.

## RECOMMENDATIONS FOR LIFELINE SEISMIC STANDARDS

The recommendations that follow reflect current policies and practices. Should major modifications of these policies and practices be enacted, such as a Federal earthquake insurance and reinsurance program that includes lifeline elements, the recommendations should be adapted accordingly.

Concurrently with drafting of lifeline seismic design standards previously recommended, it is recommended that:

- Federal lifeline agencies, acting through the Interagency Committee on Seismic Safety in Construction (ICSSC), undertake preparations for review, adoption, and implementation of the standards after the consensus process is completed. Preparations should include:
  - A detailed review of each Federal lifeline agency's authority to regulate or influence seismic design of lifelines under their jurisdiction.  
  
Review should be conducted by each agency's legal counsel, or by outside counsel under contract to NIST.
  - Review and propose appropriate implementation strategies for each Federal lifeline agency, including:
    1. Strategies for Federal oversight and facilitation of State and local governmental or private lifeline industry adoption of standards
    2. Cooperative "partnerships" among Federal lifeline agencies, State and local governments, and private lifeline industries
    3. Strategies as in #1 and #2, backed by Federal authority to regulate if State and local governments or private lifeline industries fail to act
    4. Federal agencies' incorporation of lifeline seismic design standards into their regulations by reference for all federally financed and safety regulation lifeline programs, contracts for lifelines facilities and services, and disaster relief programs
    5. Strategies for adoption and implementation of lifeline seismic design standards by Federal agencies that own or operate lifeline facilities.
  - Draft and review a model executive order to be applicable to Federal lifeline agencies, articulating Federal policies toward seismic design standards, and directing Federal lifeline agencies to plan for adoption and use of the standards.
  - Identify those agencies that do not have statutory authority over lifeline seismic design standards for lifelines under their jurisdiction, and identify appropriate implementation and legislative strategies.
- Based on the studies, strategies, and plans so prepared, once the design standards consensus process has been completed we recommend that:

- The Federal agencies act to have an executive order adopted on lifelines
- Federal legislation be drafted and enacted where needed to ensure adoption and application of the seismic design standards
- Each Federal lifeline agency move promptly to implement the plans and strategies deemed most appropriate for the lifelines under their jurisdiction.

#### VII-4 ACKNOWLEDGMENTS

Review was provided by Craig E. Taylor, Dames & Moore; Robert A. Olson, President, VSP Associates, Inc.; Dr. Joanne Nigg, Director, Disaster Research Center; Dr. Harold C. Cochrane; and Dr. William J. Petak, University of Southern California.

#### VII-5. REFERENCES

1. National Earthquake Hazards Reduction Program Reauthorization Act, §8(b), 42 U.S.C. 7701 et seq., as amended.
2. National Institute of Standards and Technology, 1991. "An Overview of Standards Terminology and the Standards Development Process," Gaithersburg, MD.
3. OMB Circular No. A-119, Revised, "Federal Participation in the Development and Use of Voluntary Standards," October 26, 1982.
4. Ibid., §7.a. (1) - (5).
5. Rossi, Peter H., James D. Wright and Eleanor Weber-Burdin, 1982, *Natural Hazards and Public Choice: The State and Local Politics of Hazard Mitigation*. New York: Academic Press. See also James D. Wright, 1980, "The State and Local Politics of Seismic Hazard," in *Social and Economic Impact of Earthquakes on Utility Lifelines*, American Society of Civil Engineers, New York.
6. Mittler, Elliott, 1989, *Natural Hazard Policy Setting: Identifying Supporters and Opponents of Nonstructural Hazard Mitigation*. Monograph #48. Institute of Behavioral Science, University of Colorado, Boulder.
7. Ibid., p. 196.
8. Ibid., p. 192.
9. Nigg, Joanne M., 1986, "Factors Affecting the Improvement of Seismic Hazard Abatement Practices in Public Works Departments and Utility Companies," in *Abatement of Seismic Hazards to Lifelines: Proceedings of a Workshop on Development of an Action Plan*, FEMA 143, vol. 6, Federal Emergency Management Agency, Washington, DC.

## RECOMMENDATIONS FOR LIFELINE SEISMIC STANDARDS

10. Ibid., at p. 47. See also Mushkatel, Alvin H., and Joanne M. Nigg. 1987. "The Effect of Objective Risk on Key Actor Support for Seismic Mitigation Policy." *Environmental Management* 11:77-86.
11. Turner, Ralph H., Joanne M. Nigg, and Denise Heller Paz. 1986. *Waiting for Disaster*. Berkeley: University of California Press.
12. Association of Bay Area Governments. 1988. *Liability of Local Governments for Earthquake Hazards and Losses: Background Research Reports*, Background Research Report #3. Oakland, CA.
13. Nigg, Joanne M., op. cit., note 9.
14. Wright, James D., op. cit., note 5.
15. Observations in the first two pages of this section are a composite of comments made by participants in a Forum on Economic Consequences of a Catastrophic Earthquake, sponsored by the Commission on Engineering and Technological Systems, National Research Council, 1990. We gratefully acknowledge the insights of Leonard K. Cheng, Harold E. Cochrane, Howard Kunreuther, Tappan Monroe, Richard L. Roth, Jr., Barbara D. Stewart, Thomas L. Tobin, and Anthony Yezer.
16. P.L. 100-707, §406 (1988).
17. Ibid., §102.(8).
18. Ibid., §404.
19. See FEMA-200, September 1990. *Loss-Reduction Provisions of a Federal Earthquake Insurance Program*, at p. 1-10. Federal Emergency Management Agency, Washington, DC. See also Cheney, D. and D. Whiteman. 1987. "Earthquake Insurance: Problems and Options." Prepared by the Congressional Research Service for the Committee on Commerce, Science, and Transportation. Senate, 99th Congress, 2d Session. Senate Print 99-220. Washington, DC: U.S. Government Printing Office.
20. FEMA-200, Id., note 11.
21. Howe, Charles W. and Harold E. Cochrane et al. 1991. *Natural Hazards Damage Handbook: A Guide to the Uniform Definition, Identification and Measurement of Damages from Natural Hazard Events*. NSF Grant CES 8717115. Available through NTIS.
22. C. Taylor, H. Seligson, and C. Tillman, 1991, "Loss-Reduction for Lifelines in a Federal Earthquake Insurance Context: Some Preliminary Issues," paper presented to the ASCE/TCLEE National Conference on Seismic Design of Lifelines, Los Angeles, California.
23. A.Z. Rose, 1980, "Utility Lifelines and Economic Activity in the Context of Earthquakes," in *Social and Economic Impact of Earthquakes on Utility Lifelines*, American Society of Civil Engineers, New York.

24. Applied Technology Council, 1991, ATC-25, *Seismic Vulnerability and Impact of Disruption of Lifelines in the Conterminous United States*.
25. ATC-25, *ibid.*, §2.2.
26. *Ibid.*, §6.5.1.2.
27. A.Z. Rose, *op. cit.*, endnote 23, p. 116.
28. Other source documents for seismic standards for buildings include: the ANSI A 59.1-1982, *Minimum Design Loads for Buildings and Other Structures*; NEHRP *Recommended Provisions for the Development of Seismic Regulations for New Buildings*, FEMA 95, Earthquake Hazards Reduction Series 17, February 1986, amended 1988; and the SEAOC *Tentative Lateral Force Requirements*, 1985. Tri-service manuals published by military departments include *Seismic Design for Buildings*, TM 5-809-10, February 1982, and *Seismic Design Guidelines for Essential Buildings*, TM 5-809-10-1, Ch. 13, February 1986.
29. International Conference of Building Officials, *Uniform Building Code*, and related codes, Whittier, California; Building Officials and Code Administrators International, Inc., *BOCA National Building Code*, and related codes, Country Club Hills, Illinois; Southern Building Code Congress International, Inc., *Standard Building Code*, and related codes, Birmingham, Alabama.
30. See Miller, H. Crane. 1990. *Hurricane Hugo: Learning from South Carolina*. Technical report, Office of Ocean and Coastal Resources Management, National Ocean Service, National Oceanic and Atmospheric Administration, U.S. Department of Commerce. Washington, D.C.
31. Rules of the House of Representatives, Rule X.2(b)(1).
32. *Ibid.*, Rule X.5(a) and (b).
33. *Ibid.*, Rule X.5(c).
34. See Robert A. Olson, et al., 1989, *To Save Lives and Protect Property: A Policy Assessment of Federal Earthquake Activities, 1964-1987*, FEMA-181, Federal Emergency Management Agency, Washington, DC, chs. 2 and 3.
35. See, e.g., E.O. 12699, Seismic Safety of Federal and Federally Assisted or Regulated New Building Construction.
36. 1 Corinthians 14:8.

RECOMMENDATIONS FOR LIFELINE SEISMIC STANDARDS

TABLE 1

U.S. STANDARDS AND THEIR DEVELOPERS

Government	Number of Standards		Percent
Defense Department	38,000		40%
Federal procurement (GSA)	6,000		6%
Other Federal agencies	<u>8,500</u>		<u>9%</u>
Total Government Standards	52,500	55%	
<b>Private Sector</b>			
Scientific & Professional Societies	13,000		14%
Trade Associations	14,500		16%
Standards Developing Organizations	<u>14,000</u>		<u>15%</u>
Total Private Sector	41,500	45%	
Total Government & Private Sector	94,000		

Source: National Institute of Standards and Technology. 1991, Internal Report IR 4618, *Standards for the Physical Protection of National Resources and Facilities*, Appendix A, "An Overview of Standards Terminology and the Standards Development Process," Gaithersburg, MD.

**TABLE 2**  
**OVERLAPPING CATEGORIES OF SECONDARY LOSS**  
**FROM LIFELINE NETWORK DISRUPTION**

<p>I. <b>ECONOMIC LOSS (Value Of Foregone Production Of Goods And Services)</b></p> <p>Direct repair and emergency costs to utilities and other lifelines  Resolution of bankruptcies  Property losses from flooding  Property losses from fires, explosions  Increased health care costs  Decreased property tax revenue to local governments  Impacts on interdependent lifelines  Decline in utility revenue from service losses  Increased individual and business tax burdens  Reduced emergency inventories</p> <p>II. <b>HEALTH AND SAFETY LOSSES</b></p> <p>Injury or death from fires, floods, explosions, contaminants, cold weather  Sickness from toxic fumes, epidemics, lack of water, lack of heating during cold weather  Environmental degradation from culinary water contamination, toilet pressure losses, spills  Impeded operations at hospitals, health labs, nursing homes  Psychological trauma--depression, shock, etc.</p> <p>III. <b>COMMUNITY, POLITICAL, AND OTHER PERSONAL PROBLEMS</b></p> <p>Homelessness, housing dislocations, relocations  Increased needs and costs of security  Increased governmental intervention  Alteration of land and property values  Increased community burdens  Decline in community attractiveness  Disruption of education  Reduced cultural, aesthetic, and recreational opportunities  Family disruptions  Public and private liability suits  Adverse publicity for Government officials, disrupted lifelines</p>
--

**SOURCE:** Adapted from Taylor, C., H. Seligson, and C. Tilman. 1991. "Loss-Reduction for Lifelines in a Federal Earthquake Insurance Context: Some Preliminary Issues," paper presented to the Third US Conference on Lifeline Earthquake Engineering, Los Angeles, August 1991.

RECOMMENDATIONS FOR LIFELINE SEISMIC STANDARDS

TABLE 3  
SELECTED COLUMNS FROM AN INPUT-OUTPUT TABLE OF THE SAN FRANCISCO BAY AREA FOR THE YEAR 1977  
(IN THOUSANDS OF DOLLARS)

Inputs	Paperboard Boxes	Plastics	Petroleum Refining	Pumps and Compressors	Communication	Electric Companies	Gas Companies	Water and Sanitary
1. Agriculture & Mining	0	0	163,734	0	0	0	68,272	9,487
2. Construction	1,215	603	37,559	531	47,569	42,404	15,703	46,337
3. Ordnance	0	0	0	35	0	10	0	0
4. Food & Kindred Prods.	41	280	2,705	0	0	87	0	0
5. Textiles	287	38	161	71	305	262	85	243
6. Lumber & Furniture	512	152	55	292	0	44	0	0
7. Paper	111,646	2,835	6,186	163	982	895	293	527
8. Publishing	1,058	31	186	38	2,687	1,114	348	589
9. Chemicals & Products	10,936	48,146	365,031	1,710	9,728	29,075	1,205	7,684
10. Rubber & Plastics	1,088	2,980	2,612	1,233	294	344	4	54
11. Leather	10	3	62	176	0	77	0	0
12. Stone, Clay & Glass	89	50	109	636	9	30	0	0
13. Primary Metals	1,165	180	1,719	12,320	650	958	562	0
14. Fabricated Metals	4,037	196	9,917	5,325	16	309	0	752
15. Machinery exc. Electrical	864	221	8,444	22,123	23	68	0	32
16. Electrical Equipment	41	41	1,190	6,551	25,615	3,210	47	30
17. Transport Equipment	0	8	111	1,075	155	89	0	0
18. Misc. Manufacturing	145	27	1,126	1,075	387	7	0	0
19. Transportation	8,736	1,691	41,850	1,379	3,657	24,699	165	1,276
20. Communication	1,677	457	2,783	1,593	15,776	4,406	2,663	3,682
21. Radio & TV Broadcasting	0	0	0	0	0	0	0	0
22. Electric Co. & Systems	1,562	1,020	14,926	692	6,400	80,101	2,034	14,393
23. Gas Co. & Systems	695	378	33,366	249	2,060	44,922	348,104	10,431
24. Water & Sanitary Services	121	134	4,906	78	2,101	1,036	503	462
25. Wholesale & Retail	8,393	3,905	21,729	6,373	14,941	11,228	2,157	5,242
26. Finance & Real Estate	6,026	2,754	99,843	2,908	44,867	12,803	9,375	24,569
27. Services	9,719	3,887	100,367	6,247	91,598	16,597	10,254	17,898
28. Federal Government	227	42	1,509	195	6,362	3,103	2,198	3,066
29. State & Local Government	8	12	30	8	293	129,625	11,359	371,184
30. Miscellaneous	938	0	5,074	1,862	14,810	4,447	3,138	4,117
31. Imports	28,797	31,201	1,503,119	33,484	28,811	178,037	201,515	146,277
32. Value Added	104,040	27,805	331,047	73,351	1,617,602	649,322	351,170	162,479
33. Total Gross Output	304,073	129,097	2,752,576	181,446	1,939,898	1,339,308	1,031,154	830,831

SOURCE: Everard Lolling, "Preliminary Input output Table Of The San Francisco Bay Area," Engineering Economics Associates, Inc. Berkeley, California, 1980 (computer tape)

FROM: Rose, Adam Z., 1980, "Utility Lifelines and Economic Activity in the Context of Earthquakes," in *Social and Economic Impact of Earthquakes*, American Society of Civil Engineers, New York



**TABLE 4**  
**ESTIMATED DIRECT AND INDIRECT DAMAGE DOLLAR LOSSES TO LIFELINES**

REGION	EVENT	SURFACE MAGNITUDE	LOSSES IN BILLIONS OF DOLLARS		
			DIRECT DOLLAR LOSS	INDIRECT DOLLAR LOSS	TOTAL ESTIMATED LOSSES
Northeastern	Cape Ann, MA	7.0	\$4.20	\$9.10	\$13.30
Southeastern	Charleston, SC	7.5	\$4.90	\$10.20	\$15.10
Central	New Madrid, MO	7.0	\$3.40	\$4.90	\$8.30
Central	New Madrid, MO	8.0	\$11.80	\$14.60	\$26.40
Western Mountain	Wasatch Front, UT	7.5	\$1.50	\$3.90	\$5.40
Northwestern	Puget Sound, WA	7.5	\$4.40	\$6.10	\$10.50
Southern California	Fort Tejon, CA	8.0	\$4.90	\$11.70	\$16.60
Northern California	Hayward, CA	7.5	\$4.60	\$11.10	\$15.70

SOURCE: ATC-25, 1991, *Seismic Vulnerability and Impact of Disruption of Lifelines in the Conterminous United States*, Table 4-4 and tables at §§5.5, 6.6, and 7.7, combined.

RECOMMENDATIONS FOR LIFELINE SEISMIC STANDARDS

Table 5

NATIONAL EARTHQUAKE HAZARDS REDUCTION PROGRAM

Agencies	Authorizing Committees		Appropriations Subcomms.	
	Senate	House	Senate	House
USGS	C, S & T	S, S & T	I & RA	I & RA
NSF	C, S & T	S, S & T	V, H & IA	V, H & IA
FEMA	C, S & T	S, S & T	V, H & IA	V, H & IA
MIST	C, S & T	S, S & T	C, J, S, J&RA	C, J, S, J&RA

AUTHORIZING COMMITTEES AND APPROPRIATIONS SUBCOMMITTEES FOR FEDERAL "LIFELINE" AGENCIES

A. Electrical Power

Agencies	Authorizing Committees		Appropriations Subcomms.	
	Senate	House	Senate	House
FERC; TVA	E & NR	E & C	E & WD	E & WD
APA; BPA; SEPA; WAPA	E & NR	E & C	I & RA	I & RA
REA	A, N & F	Agric.	A, RD & RA	RD, A & RA

B. Gas and Liquid Fuels

Agencies	Authorizing Committees		Appropriations Subcomms.	
	Senate	House	Senate	House
FERC	E & NR	E & C	E & WD	E & WD
DOT/OPS	E & NR	E & C	T & RA	T & RA

C. Telecommunications

Agencies	Authorizing Committees		Appropriations Subcomms.	
	Senate	House	Senate	House
FCC	C, S & T	E & C	C, J, S, J&RA	C, J, S, J&RA

D. Transportation

Agencies	Authorizing Committees		Appropriations Subcomms.	
	Senate	House	Senate	House
1. Highways				
FHWA	E & PW	PW & T	T & RA	T & RA
2. Heavy Rail				
FRA	C, S & T	E & C	T & RA	T & RA
3. Light Rail				
UMTA	B, H & UA	PW & T	T & RA	T & RA
4. Airports				
FAA	C, S & T	PW & T	T & RA	T & RA
5. Ports and Harbors				
COE	E & PW	PW & T	E & WD	E & WD

E. Water and Sewer

Agencies	Authorizing Committees		Appropriations Subcomms.	
	Senate	House	Senate	House
EPA	E & PW	PW & T	V, H & IA	V, H & IA

Table 5 (Continued)

**GLOSSARY OF ACRONYMS**

Agencies (19)

APA = Alaska Power Administration  
 EPA = Bonneville Power Administration  
 COE = U.S. Army Corps of Engineers  
 EPA = Environmental Protection Agency  
 FAA = Federal Aviation Administration  
 FCC = Federal Communications Commission  
 FEMA = Federal Emergency Management Agency  
 FERC = Federal Energy Regulatory Commission  
 FHWA = Federal Highway Administration  
 FRA = Federal Railroad Administration  
 NIST = National Institute of Science and Technology  
 NSF = National Science Foundation  
 OPS = Office of Pipeline Safety  
 REA = Rural Electrification Administration  
 SEPA = Southeast Power Administration  
 TVA = Tennessee Valley Authority  
 UMTA = Urban Mass Transportation Administration  
 USGS = United States Geological Survey  
 WAPA = Western Area Power Administration

Authorizing Committees (5 Senate; 3 House)

A,N & F = Senate Agriculture, Nutrition & Forestry  
 B,H & UA = Senate Banking, Housing & Urban Affairs  
 C,S & T = Senate Commerce, Science & Transportation  
 E & NR = Senate Energy & Natural Resources  
 E & PW = Senate Environment & Public Works

Agric. = House Agriculture  
 E & C = House Energy & Commerce  
 PW & T = House Public Works & Transportation

Appropriations Subcommittees (6 Senate; 6 House)

A, RD & RA = Senate Agriculture, Rural Development and Related Agencies  
 C, J, S, J & RA = Senate/House Commerce, Justice, and State, the Judiciary and Related Agencies  
 E & WD = Senate/House Energy and Water Development  
 I & RA = Senate/House Interior and Related Agencies  
 RD, A & RA = House Rural Development, Agriculture and Related Agencies  
 T & RA = Senate/House Transportation and Related Agencies  
 V, H & IA = Senate/House VA, HUD, and Independent Agencies

## RECOMMENDATIONS FOR LIFELINE SEISMIC STANDARDS

### VII-A. APPENDIX A--FEDERAL REGULATION OF LIFELINES

Appendix A reviews existing Federal laws and regulations for the lifelines included in the report. It reflects jurisdiction over lifelines spread not only among many Federal executive agencies, but equally important, among many congressional authorizing committees and subcommittees. Inherent in any discussion of Federal regulations of lifelines are issues of State and local authority. For many of the lifelines, the principal regulatory authority is vested in and exercised by State, regional, or local governmental jurisdictions. Suffice it for this report that State, regional, or local authority is broadly recognized, but is not analyzed.

The pattern of Federal regulation of lifelines is uneven, a result that reflects the jurisdictional tensions among local, regional, State, and Federal authorities, and reflects political perceptions of the priority and imminence of earthquake hazards in competition with other issues pressing social, economic, and political agendas. Only two agencies included in this report have seismic design standards for the lifelines under their control--the Federal Highway Administration and the Office of Pipeline Safety, both of the Department of Transportation. Other agencies require that the buildings housing lifeline facilities be built to comply with the seismic standards of the Uniform Building Code, or with State or local building standards.

Among Federal agencies that require attention to seismic design, the most typical approach has been to incorporate by reference into their regulations State, local, or model building codes for building structures, and design standards of voluntary standards bodies for highways, bridges, and equipment. Incorporation by reference has the same legal effect as if the regulations were published by the agency in full--they become the minimum standards required by the agency. Whether and how the agencies enforce the regulations is not evaluated here.

If a coherent Federal program to develop, adopt, and implement lifeline seismic design standards is to emerge, it must account for and respect various Federal, State, and local governmental authorities. Successful development of design standards requires the participation and consensus of various voluntary standard-making and standard-issuing bodies. Successful implementation of a coherent Federal program will balance any private sector economic needs with the life-safety, business continuity, disaster assistance, and other social, economic, and political goals of regulatory intervention.

#### VII-A.1 Electrical Power Facilities

Most electrical power system business is intrastate and is regulated by State public utility commissions. To a great extent electric companies are natural monopolies, that is, one firm can provide service within its territory more efficiently than can two or more firms. In return for exclusive operating franchises within a particular territory, prices for electricity are controlled by the State regulatory agencies, and the utilities are required to provide a specified level of service. Among State public utility commissions only California's has extended its authority to include regulation of seismic design.<sup>1</sup>

Federal regulation extends to the transmission and use or sale of electric energy at wholesale rates among utility companies in interstate commerce. Administered by the Federal Energy Regulatory Commission (FERC), the Act limits FERC's regulation "to those matters which are not subject to regulation by the States."<sup>2</sup> With certain exceptions, the Commission does *not* have jurisdiction over generation facilities, those used in local distribution or transmission in intrastate commerce, or over facilities used to transmit electric energy which is wholly consumed by the transmitter.<sup>3</sup>

FERC has authority to establish regional districts for voluntary interconnection and coordination of facilities for generation, transmission, and sale of electric energy; to establish physical connections of transmission facilities; to require temporary connections in time of emergency; and to require public utilities to submit contingency plans respecting shortages of electric energy.<sup>4</sup> The Commission may recommend to electric utilities voluntary negotiations to increase reliability through pooling arrangements.<sup>5</sup> The Secretary of Energy may recommend industry standards for reliability to the electric utility industry.

These authorities reflect a legislative and regulatory deference not only to the States but also to the electric utility industry--an apparent deference to State authority and voluntary cooperative action by the industry. The authorities were not intended to be and have not been extended to Federal requirements for seismic design.

### **Authorizing Committees**

- **Senate**--Committee on Energy and Natural Resources, Subcommittee on Energy Regulation and Conservation
- **House**--Committee on Energy and Commerce, Subcommittee on Energy and Power

### **Legislative Authority**

- Federal Power Act of 1920, 16 U.S.C. 791a *et seq.*, as amended.
- Public Utility Regulatory Policies Act of 1978, 16 U.S.C. 2601.
- Tennessee Valley Authority Act of 1933, as amended, 16 U.S.C. 831 - 831dd.
- Rural Electrification Act of 1936, 7 U.S.C. 901 *et seq.*, as amended.
- Western Area Power Administration, 42 U.S.C. 7275.
- Southeastern Power Administration, 42 U.S.C. 7152.

### **Regulations**

- Federal Energy Regulatory Commission, 18 CFR, Ch. 1 (4-1-91 Edition). 18 CFR ch. I, Pt. 32 (4-1-91 Edition), Pt. 294 (4-1-90 Edition).
- Tennessee Valley Authority, 18 CFR, Ch. XIII (4-1-90 Edition).
- Rural Electrification Administration, 7 CFR Ch. XVII (1-1-91 Edition)

### **Federal Electrical Power Systems**

- The Federal Emergency Management Agency's *Earthquake Resistant Construction of Electric Transmission and Telecommunication Facilities Serving the Federal Government Report*, identified three types of electrical power system lifelines which could be required to meet federally imposed standards:

(1) lifelines which are owned and operated by the Federal Government, such as the Western Area Power Administration electrical transmission lines; (2) lifelines which are owned and operated by others, but have a major contractual obligation to serve the Federal Government, such as the Southeastern Power

## RECOMMENDATIONS FOR LIFELINE SEISMIC STANDARDS

Administration electrical transmission . . .; and (3) lifelines which are constructed with Federal funds, but not owned by the Federal Government, and which do not have a major contractual obligation to serve the Federal Government, such as electrical transmission lines financed by the Rural Electrification Administration.

- The Tennessee Valley Authority (TVA) is an example of a federally owned and operated system whose electric power program is financially self-supporting. The western part of TVA's jurisdiction is vulnerable to earthquakes. TVA uses no seismic design for transmission lines and towers, but does anchor transformers and other large equipment against 0.2 G seismic acceleration. Other equipment is not tied down. TVA has experienced no damaging seismic events in its 60-odd-year history.
- Each of the power administrations under the Department of Energy (Alaska, Bonneville, Southeastern and Western Area) set their own policies for earthquake hazard reduction.
  - The Alaska Power Administration is responsible for operating two Federal hydroelectric projects in Alaska, including transmission and marketing the electric power generated there. The Administration subcontracts its construction to the Corps of Engineers, which reports that it uses Corps criteria for earthquake resistant design (and has since 1964).
  - The Bonneville Power Administration markets and transmits electric power from Corps of Engineers and Bureau of Reclamation hydroelectric projects in the Pacific Northwest. The Administration constructs, operates, and maintains a transmission system that integrates Federal power projects and interconnects with non-Federal electric utility systems.

The Administration adopted seismic design criteria and standards for transferable equipment such as transformers and power circuit breakers, and for nontransferable equipment such as footings and support structures. A Draft/Interim Seismic Policy for Transferable and Fixed Equipment, dated April 13, 1991, increases the horizontal ground motion acceleration standard to be used in all seismic zones in the Administration's system when procuring transferable equipment and designing nontransferable items. Modifications to improve seismic performance of existing facilities and equipment are limited to 10 percent of the initial equipment costs.
  - The Southeastern Power Administration transmits and sells surplus electric power generated at Corps of Engineers reservoir projects in 10-State area of the Southeast. It subcontracts power transmission to private utilities, and makes no attempt to impose seismic design criteria on those utilities.
  - The Western Area Power Administration markets and transmits electric power generated by the Bureau of Reclamation, Corps of Engineers, and the International Boundary and Water Commission, in 15 central and western States. The Administration has no special standards for electrical transmission lines; transmission and microwave towers are generally built

away from known faults; substations are designed to withstand seismic forces, if warranted; substation equipment in high seismic risk zones must meet the requirements of IEEE Standard 693-1984; and buildings are designed according to the Uniform Building Code.

- The Rural Electrification Administration (REA) of the US Department of Agriculture finances rural electrical systems; it does not own them. The REA's Bulletin 65-1, *Rural Substations*, 1978, recognizes earthquakes as a risk, but does not require compliance with IEEE Standard 693-1984 or any other standard.
- Military criteria for buildings and equipment tie-down are found in Technical Manuals TM 5-809-10, 1982, TM 5-809-10-1, 1986, and US Army Corps of Engineers CEGS 15200, 1985.

### **Standards And Design Guidelines--Electrical Equipment In Substations**

- Standards published by the American National Standards Institute (ANSI) and the Institute of Electrical and Electronic Engineers (IEEE) form the basis for seismic design of electrical equipment in substations. See ANSI/IEEE Standard 693-1984 and ANSI/IEEE Standard 344-1987, "IEEE Recommended Practice for Seismic Qualification of Class 1E Equipment for Nuclear Power Generating Stations." These standards have performance criteria for all substation components and equipment qualification criteria.

Three California power companies consider ANSI/IEEE Standard 693-1984 inadequate and have developed their own specifications for construction of earthquake resistant electrical substations. Based on adverse experience from the 1971 San Fernando and 1986 North Palm Springs earthquakes, the 1989 Loma Prieta earthquake made clear that certain design practices still need to be improved. Ceramic components of circuit breakers continue to be particularly vulnerable.

- ANSI/IEEE Standard 693-1984.
- ANSI/IEEE Standard 344-1987, "IEEE Recommended Practice for Seismic Qualification of Class 1E Equipment for Nuclear Power Generating Stations."
- SEAOC "Tentative Lateral Force Requirements," 1985.
- MIL-HDBK-1004/4, "Electrical Utilization Systems," 1987.
- CEGS-15200, "Guide Specification, Military Construction ... Seismic Protection for Mechanical, Electrical Equipment," 1985.

### **VII-A.2 Gas And Liquid Fuel Facilities**

The same basic State public utility regulatory concepts pertain to gas and liquid fuel facilities as for electrical power facilities. Despite a number of formal similarities in regulatory patterns, Federal regulation of private gas and liquid fuel facilities is more pervasive than for electrical power facilities.

Three Federal agencies administer regulatory programs for pipeline fuel transportation systems:

## RECOMMENDATIONS FOR LIFELINE SEISMIC STANDARDS

- The Department of Transportation's Office of Pipeline Safety regulates pipeline safety standards, including a program through which States can voluntarily assert safety regulatory jurisdiction over all or some intrastate pipeline facilities.
- The Department of Energy's Federal Energy Regulatory Commission regulates interstate fuel transmission rates charged by oil and gas transmission lines, and regulates safety and environmental requirements of gas pipelines and all liquefied natural gas (LNG) facilities.
- The Department of the Interior's Minerals Management Service regulates safety and environmental compliance of offshore oil and gas production and transmission facilities.

For the purposes of this plan, offshore oil and gas production and transmission facilities and LNG facilities are excluded.

The principal standards for pipelines include Federal regulations, rules, and safety standards of the California Public Utility Commission, American Society of Mechanical Engineers and American Petroleum Institute standards, and military standards.

### **Pipeline Standards**

Federal pipeline safety regulations administered by the Office of Pipeline Safety are found in 49 CFR, Ch. I, Pts. 190, 192, 193, and 195. Federal natural gas pipeline safety regulations found in 49 CFR, Pt. 192, "Transportation of Natural and Other Gas by Pipeline: Minimum Federal Safety Standards," do not include overt seismic design requirements. Earthquake resistant design of pipelines for transportation of hazardous materials is required in 49 CFR, Pt. 195.

Military design manuals (NAVFAC DM 22) and specifications (CEGS Specification 02685) incorporate ASME Standards B31.4 and B31.8, respectively.

The California Public Utility Commission General Order 112-D contains design requirements considered by some to be more conservative than those for nuclear power plants.

### **Storage Tanks**

49 CFR 195 incorporates by reference API Standard 650, "Welded Steel Tanks for Oil Storage," which contains detailed seismic design requirements in Appendix E.

Seismic design standards similar to API 650 are included in ANSI/AWWA Standard D100, "Standard for Welded Steel Tanks for Water Storage."

### **Authorizing Committees**

- Senate--Committee on Energy and Natural Resources, Subcommittee on Energy Regulation and Conservation.
- House--Committee on Energy and Commerce, Subcommittee on Energy and Power.



### Legislative Authority

- Natural Gas Pipeline Safety Act of 1968, as amended, 49 App. U.S.C. 1671 *et seq.*
- Hazardous Liquid Pipeline Safety Act of 1979, Title II, 49 App. U.S.C. 2001 *et seq.*
- Hazardous Materials Transportation Act, as amended, 49 App. U.S.C. 1801 *et seq.*
- Federal Power Act of 1920, as amended, Subch. II, 16 U.S.C. 791a *et seq.*  
Public Utility Regulatory Policies Act of 1978, 16 U.S.C. 2601 *et seq.*

### Regulations

- 18 CFR (4-1-91 Edition) Ch. I.
- 49 CFR (10-1-90 Edition) Ch. 1.
  - Pt. 190, Pipeline Safety Program Procedures.
  - Pt. 192, Transportation of Natural and Other Gas by Pipeline: Minimum Federal Safety Standards.
  - Pt. 193, Liquefied Natural Gas Facilities: Federal Safety Standards.
  - Pt. 195, Transportation of Hazardous Liquids by Pipeline.

### Standards And Guidelines

- ASME(ANSI) B31.4, Liquid Transportation Systems for Hydrocarbons, Liquefied Petroleum Gas, Anhydrous Ammonia, and Alcohols.
- ASME(ANSI) B31.8, Gas Transmission and Distribution Piping Systems.
- California Public Utility Commission, General Order 112-D, Rules Covering Design, Construction, Testing, Maintenance and Operations of Utility Gas Gathering, Transmission, and Distribution Piping Systems; Liquid Natural Gas Facilities Safety Standard.
- API Recommended Practice 1102, 1981. [Recommended practices for liquid petroleum pipeline crossings at railroads and highways].
- ASCE Interim Specifications for the Design of Pipeline Crossings at Railroads and Highways, 1964.
- API Standard 650, Welded Steel Tanks for Oil Storage.
- ANSI/AWWA D100, Standard for Welded Steel Tanks for Water Storage.

## RECOMMENDATIONS FOR LIFELINE SEISMIC STANDARDS

- NFPA 59A, Standard for the Production, Storage, and Handling of Liquefied Natural Gas (LNG).

### VII-A.3 Telecommunication Facilities

Although once dominated by a unified Bell System, telecommunications system business is subject to the same basic public utility regulatory concepts as is electrical power systems. Intrastate business is regulated by State public utility commissions. In return for operating franchises within a particular territory, rates for telecommunications are controlled by the State regulatory agencies and the utilities are required to provide a specified level of service. To a limited degree, on the West Coast State public utility commissions have implemented seismic design for telecommunications systems; State or local construction codes set minimum standards for buildings.

The Federal Communications Commission (FCC) regulates interstate and foreign telecommunications. Federal regulatory authority has generally not been exerted for seismic design of telecommunications buildings or equipment. No regulations for seismic design standards have been published by the FCC.

Design standards for telecommunications are developed by individual companies. Bell Communications Research (Bellcore) develops standards on behalf of the Bell Operating Companies created after AT&T was broken up. Bellcore developed generic equipment design criteria published in their technical reference TR-EOP-000063, March 1988. These standards and others published as "information letters" by Bellcore are accepted by the Bell companies. In addition, the Applied Technology Council's ATC-3-06 covers in-building equipment installations. MCI Telecommunications uses its own engineering standards based on a company policy to provide premier quality service, that is, to sustain coverage during any emergency, especially for major accounts that will not accept outages.

#### Authorizing Committees

- **Senate**--Committee on Commerce, Science, and Transportation, Subcommittee on Communications.
- **House**--Committee on Energy and Commerce, Subcommittee on Telecommunications and Finance.

#### Legislative Authority

- Federal Communications Act, 47 U.S.C. 101 *et seq.*
- General Services Act, 40 U.S.C. 757; 47 U.S.C. 305 note, Executive Order 12-046; 50 App. U.S.C. 2251. [The General Services Administration has private telecommunication lines with 58 main nodes and awards 3-day tariffs for circuits. Some facilities are hardened for emergency use. Private industry tariffs do not include explicit requirements for earthquake-resistant design. See FEMA-202, September 1990, p. 39.]

#### Regulations

- 47 CFR (10-1-90 Edition) Ch. I. [No Federal seismic design regulations have

been published by the FCC.]

### **Standards And Design Guidelines**

- Bellcore Technical Reference TR-EOP-000063. March 1988. "Network Equipment Building System (NEBS)." Bell Communications Research.
- ATC-3-06. 1984. Tentative Provisions for the Development of Seismic Regulations for Buildings. Applied Technology Council.
- Telecommunications systems and equipment are designed and built to individual company specifications. The designs to these specifications are normally proprietary to the company. Specifications specify individual equipment, but not total system design. There is no standard that controls total system performance. Standards are limited to individual equipment.

### **VII-A.4 Transportation Facilities**

#### **VII-A.4.1 Highways**

Federal regulation of highway programs is administered through the Department of Transportation's Federal Highway Administration (FHWA). FHWA administers (1) the Federal-aid highway program, 23 U.S.C., Ch. I, (2) the Highway Bridge Replacement and Rehabilitation Program to assist in the replacement and rehabilitation of bridges both on and off the Federal-aid highway systems, and (3) an emergency program to assist in the repair or reconstruction of Federal-aid highways and certain Federal roads seriously damaged by natural disasters or catastrophic failures. In addition, FHWA is directly involved in the design and construction of roads and bridges within Federal lands, e.g., Forest Highways, Indian Reservation Roads, Park Roads and Parkways, and Public Lands Highways, 23 U.S.C., Ch. II.

A cooperative program with State highway agencies, the Federal-aid highway program is funded by user taxes on gasoline, diesel fuel, tires, and truck sales under the Highway Trust Fund, 23 U.S.C. 9503. States are responsible for planning, designing, constructing, and maintaining federally funded highway projects. Highway facilities are owned by the States. States determine which highway projects will be federally funded. FHWA reserves authority to approve key actions in the process from planning through construction and operation.

FHWA has not created its own design standards for highways, but rather works closely with and incorporates by reference design specifications or interim specifications published by the American Association of State Highway and Transportation Officials (AASHTO). See 23 CFR Pt. 625 (4-1-90 Edition), "Design Standards for Highways." The AASHTO standards are minimum standards, intended for broad national use. If a State's standards are more stringent than those adopted by AASHTO and FHWA, such as those of California, the more stringent standards apply.

FHWA's design specifications establish Federal standards for federally funded work (23 CFR 625.3(d)), that is, for about 271,300 bridges in the Federal-aid system which represent about 47 percent of the 578,000 bridges on all public highways in the country.

23 CFR 625.4 incorporates by reference AASHTO and FHWA policies, procedures, and specifications for (a) roadways and appurtenances; (b) bridges and structures; and (c) materials.

## RECOMMENDATIONS FOR LIFELINE SEISMIC STANDARDS

23 CFR 625.5 cites AASHTO guides and references for (a) roadway and appurtenance design, and (b) bridges and structures. The guides include AASHTO's *Guide Specifications for Seismic Design of Highway Bridges, AASHTO 1983, and Amending Interim Specifications, Bridges, AASHTO 1985 through 1988*. Subsequent to publication of the April 1990 edition of CFR, AASHTO adopted its Guide Specifications as Standard Specifications, published as *AASHTO 1991 Interim Specifications, Supplement A, Standard Specifications for Seismic Design of Highway Bridges*. Under FHWA policy, these will be adopted as standard specifications for Federal-aid highway projects.

Under AASHTO specifications bridges are classified by relative importance, from essential to nonessential. Essential bridges must function during and after an earthquake, and are determined according to social/survival and security/defense classification. There are four classification categories by levels of seismic performance, ranked from highest level of seismic performance to lowest (no seismic analysis required). According to the FHWA, most of the 271,300 bridges in the interstate, primary, secondary, and urban systems are in the third category (minimum of analysis required, specific attention drawn to support design details). Most bridges in California are in the two highest categories (first, design for highest level of seismic performance, with particular attention to methods of analysis, design, and quality assurance; second, slightly lower level of seismic performance, less rigorous analytical procedure than highest level).

### **Tunnels And Pavements**

There are no standard or uniform seismic design criteria for tunnels and pavements. Earthquake design criteria for tunnels are site specific, as they are for the Bay Area Rapid Transit (BART) system in the San Francisco Bay Area and for the Los Angeles Metro system. Pavements cannot be designed to resist earthquake damage and are relatively easy to repair.

### **Buildings And Related Facilities**

Design standards for buildings associated with highways, bridges, and tunnels (e.g., administrative offices, maintenance facilities, garages) are not included in the AASHTO design specifications and are not subject to FHWA regulations. Buildings are subject to the minimum standards set in the construction codes adopted by State or local governments.

For further general information on the Federal Highway Administration's seismic design regulation, see US Department of Transportation, March 1990, *Report to Congress: Adequacy of Current Federal and State Earthquake Design Standards*, Sec. III, pp. 6 - 17.

### **Authorizing Committees**

- **Senate**--Committee on Environment and Public Works, Subcommittee on Water Resources, Transportation, and Infrastructure.  
  
Committee on Commerce, Science, and Transportation, Subcommittee on Surface Transportation.
- **House**--Committee on Public Works and Transportation, Subcommittee on Surface Transportation.

**Legislative Authority**

- 23 U.S.C., Ch. 1, Federal-Aid Highways, §§101 - 158; Surface Transportation and Uniform Relocation Assistance Act of 1987, 23 U.S.C. 101.
- Highway Trust Fund, 26 U.S.C. 9503

**Regulations**

- 23 CFR, (4-1-90 Edition) Ch. 1  
Subch. G - Engineering and Traffic Operations, Pts. 620-669, Engineering. Pt. 625, Design Standards for Highways

**Standards And Guidelines**

- 23 CFR 625.4 incorporates by reference AASHTO and FHWA policies, procedures, and specifications for (a) roadways and appurtenances; (b) bridges and structures; and (c) materials.
- 23 CFR 625.4 cites *Guide Specifications for Seismic Design of Highways Bridges, AASHTO 1983, and Amending Interim Specifications, Bridges, AASHTO 1985 through 1988.*
- In 1990 the Guide Specifications were upgraded to Standard Specifications: *AASHTO 1991 Interim Specifications, Supplement A, Standard Specifications for Seismic Design of Highway Bridges.*
- There are no national design criteria for tunnels; specific design criteria have been developed by local transit agencies and their design consultants.

**VII-A.4.2 Railways****VII-A.4.2.1 Heavy Rail**

Two Federal agencies regulate different aspects of railroads in the United States: the Interstate Commerce Commission (ICC); and, for railroad safety purposes, the Department of Transportation's Federal Railroad Administration (FRA). The Interstate Commerce Commission, created in 1887, regulates interstate surface transportation (including railroads) involving certification of carriers seeking to provide transportation to the public, rates charged, and adequacy of service, among other regulatory activities.

The Federal Railroad Administration was established in 1966. Among its responsibilities it publishes and enforces rail safety regulations and administers railroad financial assistance programs. It has jurisdiction over all areas of rail safety under the Federal Railroad Safety Act of 1970. These areas include track maintenance, inspection standards, equipment standards, and operating practices. Railroad and related industry equipment, facilities, and records are inspected by the FRA.

Neither the ICC nor the FRA has seismic design or construction standards for railroads. Until the 1960s railroads were self-regulating as to railroad safety. Design of tracks, railroad bridges,

## RECOMMENDATIONS FOR LIFELINE SEISMIC STANDARDS

stations, and other related facilities was the responsibility of the individual railroads, and remains so today.

Standards published in the American Railway Engineering Association (AREA) *Manual for Railway Engineering* include tunnels (Ch. 1), timber bridges (Ch. 7), concrete bridges (Ch. 8), and steel bridges (Ch. 15), and have been incorporated by reference in FRA regulations. The manual is currently being reviewed by the Association for seismic standards and is expected to be completed by mid-1992.

Representatives of both the AREA and the FRA State that railroad bridge design is highly conservative and that no fatalities associated with railroad bridge collapse have occurred. The FRA is reluctant to impose seismic standards, with their associated costs, unless a real danger can be demonstrated. Both the AREA and the FRA argue that Federal regulation of seismic standards for railroads are not needed, a matter that may be more definitively settled after the AREA completes review of its manual.

### Authorizing Committees

- **Senate**--Committee on Commerce, Science, and Transportation, Subcommittee on Surface Transportation.
- **House**--Committee on Energy and Commerce, Subcommittee on Transportation and Hazardous Materials.

### Legislative Authority

- Interstate Commerce Act, 49 U.S.C. 10901.
- Department of Transportation Act, 49 U.S.C. 103.
- Federal Railroad Safety Act of 1970, as amended, 45 U.S.C. 431 *et seq.*

### Regulations

- Federal Railroad Administration, 49 CFR (10-1-90 Edition) Ch. II, Pts. 200-268.
- Interstate Commerce Commission, 49 CFR ch. X (10-1-90 Edition).

### VII-A.4.2.2 Light Rail

Federal involvement in light rail is a relatively recent phenomenon, less than 30 years old, with considerable tradition and precedent for State, regional, and local governmental and public transit authority ownership and operation of rail transit systems. Federal legislation and UMTA operate on the political rationale that mass transit is basically local in nature, that Federal regulation and systems standardization are to be avoided where possible.

The Urban Mass Transportation Administration (UMTA) provides Federal matching grants to finance construction and rehabilitation of public transit systems. Only state, regional, or local governmental bodies and public agencies may apply for section 3 discretionary capital grants, section 9 urbanized area formula grants, or section 18 nonurbanized area grants. About 1,500 transit systems receive UMTA funding.

UMTA States that "as a grant making agency, UMTA neither regulates construction nor sets design standards." UMTA regulations and administrative circulars do not include design standards, and contain relatively few safety provisions.

Local, regional, or State authorities that own and operate the systems are responsible for transit system design. Transit facilities include:

- Buildings--Administrative offices, terminals, and maintenance facilities (e.g., bus garages). These buildings are subject to local and State construction codes.
- Bridges And Elevated Guideway Structures--These structures are commonly part of fixed guideway systems--light rail, heavy rail, commuter rail, automated people movers, and exclusive busways. According to UMTA, transit agencies "usually require" earthquake design criteria specified by AASHTO for highway bridges.
- Underground Guideways Or Subways--As with highway tunnels, there are no national seismic design standards or criteria for underground guideways or subways. Criteria used are site specific, developed and prepared by local transit agencies and their design consultants, often building upon the seismic design experience of other systems. Examples include the BART system of San Francisco, Los Angeles Metro, Seattle's bus tunnel, and Atlanta Metro.

#### **Authorizing Committees**

- **Senate**--Committee on Banking, Housing, and Urban Affairs, Subcommittee on Housing and Urban Affairs
- **House**--Committee on Public Works and Transportation; Subcommittee on Surface Transportation

#### **Legislative Authority**

- Urban Mass Transportation Act of 1964, as amended, 49 App. U.S.C. 1601 *et seq.*
- Surface Transportation and Uniform Relocation Assistance Act of 1987, Title III (Federal Mass Transportation Act), *ibid.*

#### **Regulations**

- 49 CFR (10-1-90 Edition), Ch. VI

#### **Standards And Guidelines**

- Bridges And Elevated Guideway Structures--Transit agencies "usually require" earthquake design criteria specified by AASHTO for highway bridges, per USDOT report to Congress dated March 1990.

There is no national design criteria for tunnels; specific design criteria have been developed by local transit agencies and their design consultants.

## RECOMMENDATIONS FOR LIFELINE SEISMIC STANDARDS

### VII-A.4.3 Ports And Harbors

Ports and harbors facilities are generally owned and operated privately, or by port authorities, or by State and local governments. Those portions of ports and harbors that are included in the lifelines plan--embankments and earth retaining structures, wharves, quays, dry docks, cargo-handling equipment, pavements and aprons--are subject to virtually no Federal regulation. Corps of Engineers permits for alteration of navigable waters under §10 of the Rivers and Harbors Act of 1899 do not include design review within their purview; nor do wetland permits under §404 of the Clean Water Act, 33 U.S.C. 1344. While Liquefied Natural Gas (LNG) facilities are subject to Federal regulations, those facilities are not included in this report.

Building facilities are subject to State and local construction codes. To the extent that ports and harbors incorporate highways, bridges, tunnels, heavy rail, oil, gas and hazardous liquid pipelines elements that may be subject to Federal regulation, see those specific parts of this chapter.

#### Authorizing Committees

- **Senate**--Committee on Environment and Public Works, Subcommittee on Water Resources, Transportation, and Infrastructure.
- **House**--Committee on Public Works and Transportation; Subcommittee on Water Resources.

#### Legislative Authority

- §10, Rivers and Harbors Act of 1899, 33 U.S.C. 403 [US Army Corps of Engineers permits for alteration of navigable waters].
- §404, Clean Water Act, 33 U.S.C. 1344 [wetland permits]

[Corps of Engineers permits do not include review for seismic design.]

#### Regulations

- 33 CFR, Ch. II (7-1-90 Edition) [Corps of Engineers permits].

### VII-A.4.4 Airports

The Federal Aviation Administration, US Department of Transportation, administers two basic activities related to airports: (1) it constructs, owns, leases, or operates staffed and unstaffed facilities to provide services or information to the National Airspace System; and (2) under the Airport and Airway Improvement Act of 1982 it manages a grant-in-aid program funding airport planning and development programs through State, local, or regional airport sponsors, funded through the Airport and Airway Trust Fund.

#### VII-A.4.4.1 FAA Constructed, Owned, Leased, Or Operated Facilities

Facilities housing both staff and equipment that are constructed, owned, leased, or operated by the FAA include:



- Air Traffic Control Towers (ATCT)
- Air Route Traffic Control Centers (ARTCC) [network of 22 centers to control enroute air traffic]
- Terminal Radar Approach Control (TRACON) [identify aircraft up to 60 miles away, provide approach guidance]
- Flight Service Stations (FSS)
- Automated Flight Service Stations (AFSS) [advise on flight plans, make weather observations, advise on weather conditions]
- Airway Facilities Sector Offices (AFS)
- Airway Facilities Sector Field Offices (AFSFO)

Unstaffed facilities include radar (identify aircraft, provide speed, altitude, and weather conditions information), navigation aids (approach lighting systems, instrument landing systems), and communication (data and communications between TRACON facilities and control towers (ATCT)) facilities.

For FAA-constructed or -owned facilities, FAA contracts with architecture and engineering firms to develop designs. A limited number of control towers and navigational facilities are owned and operated by some States and airport authorities, and are generally built to FAA standards. FAA standards require that Air Traffic Control Towers meet UBC Zone 3 seismic design criteria; designs are changed for Zone 4 sites and to meet local code requirements if more stringent than UBC requirements.

#### **VII-A.4.4.2 Airport Planning And Development Programs**

The FAA administers its grant-in-aid program funding airport planning and development programs under authority of the Airport and Airways Improvement Act of 1982. Programs are funded under the Airport and Airway Trust Fund, 26 U.S.C. 9502, from aviation-user taxes.

Under the Airport Improvement Program certain nonrevenue portions of airports may be funded through the program, but are owned and operated by the airport authority. These include airport pavements and pavement structures, airport marking and lighting systems, portions of terminal buildings and crash and fire rescue facilities.

- **Airport Pavements And Pavement Structures**--As with highways, there is no practical way to isolate runways, taxiways, and aprons from ground movements induced by earthquakes, and they are relatively easy to repair. The FAA has no seismic resistant design standards for airport pavements.

Drainage culverts, taxiway/runway bridges, piers, and other pavement structures are designed to local or State codes and standards. FAA does not deem these structures unique in a civil engineering sense, but does require that bridges take into account aircraft width and the need for aircraft and emergency and other vehicles to be able to use the bridges simultaneously.

## RECOMMENDATIONS FOR LIFELINE SEISMIC STANDARDS

- **Airport Marking And Lighting Systems**--Airport marking and lighting systems are designed without consideration of earthquake movements. In case of public electric power failure certain classes of airports must have emergency power generating equipment to maintain marking and lighting systems. Otherwise there are no Federal standards or seismic design requirements for such systems.
- **Terminal Buildings And Crash And Fire Rescue Equipment Buildings**--Nonrevenue portions (about 10% - 15%) of airport terminal buildings and crash and fire rescue equipment buildings may be built with Federal funding assistance. These buildings are required to conform to local or State construction codes; no unique FAA seismic design standards exist for these buildings.
- **Parking Facilities, Hangars, And Other Airport Facilities Built Without Federal Assistance**--There is no FAA seismic design or other building standards for facilities owned, operated, and constructed by airport authorities without Federal funding assistance. The seismic requirements of local or State construction codes apply.
- **Airport Assurances**--When airport sponsors (either public agencies or private sponsors) apply for funds under the Airport Improvement Program (AIP), they must provide formal assurances that become part of the grant agreement when a grant offer is accepted. Standard Airport Assurances require the sponsor to assure and certify that they will comply with 21 specific Federal laws, 12 specific Federal regulations, 2 Executive Orders, and 2 OMB Circulars. None of the laws, regulations, orders, or circulars pertain to seismic design standards.

The assurances further provide that the sponsor will carry out the project in accordance with policies, standards, and specifications approved by the Secretary, including FAA advisory circulars for AIP projects. None of the Advisory Circulars overtly pertain to seismic design standards for AIP projects.

Sponsors further assure that they will carry out the project "in accordance with applicable State policies, standards, and specifications approved by the Secretary." This provision is the contractual basis by which airport sponsors agree to comply with Uniform Building Code seismic requirements, or with local or State construction codes and any seismic requirements in them.

### **Authorizing Committees**

- **Senate**--Committee on Commerce, Science, and Transportation; Subcommittee on Aviation.
- **House**--Committee on Public Works and Transportation; Subcommittee on Aviation.

### **Legislative Authority**

- Federal Aviation Act of 1958, as amended, 49 App. U.S.C. 1301 *et seq.*
- Airport and Airway Improvement Act of 1982, as amended, 49 App. U.S.C. 2201 *et seq.* [grant-in-aid program to fund airport planning and development pro-

grams funded under the Airport and Airway Trust Fund, 26 U.S.C. 9502].

### Regulations

- 14 CFR, Ch. 1 (1-1-91 Edition), Pts. 100 - 199.  
-- Pt. 152, Airport aid program.

### Standards And Guidelines

- **Buildings**--FAA architecture and engineering contracts for designing FAA facilities require Uniform Building Code seismic standards for *building* designs.
- **Runways And Aprons**--Runways and aprons are not practical to build to withstand earthquake damage, and are relatively easy to repair.
- **Air Bridges, Freight Handling Equipment**--No Federal standards for air bridges, freight handling equipment.
- **Airport Lighting and Marking Systems**--Designed "without regard to earthquake effects," per USDOT report to Congress March 1990, @ p. 22.
- **Airport Facilities Built Without Federal Assistance**--Automobile parking facilities, aircraft hangars. No FAA standards. Local construction codes apply.

### VII-A.5. Water And Sewer Facilities

Traditionally operated as local or regional facilities, water and sewer facilities are subject to strong Federal regulations enforced by the Environmental Protection Agency. EPA has developed national programs, technical policies, and regulations for water supply and water pollution control, for ground water protection, standards enforcement, and programs for technical assistance and technology transfer. Phasing out its formerly extensive grant-in-aid programs, EPA's mission is primarily that of a regulator, trying to control and abate pollution in many areas, including water, but without the additional leverage of grant programs.

EPA's regulations and design manuals do not include specific seismic design standards, nor incorporate voluntary standards by reference. Voluntary standards available to design professionals in the water and sewer industry are listed below.

### Authorizing Committees

- **Senate**--Committee on Environment and Public Works, Subcommittee on Environmental Protection.
- **House**--Committee on Public Works and Transportation, Subcommittee on Water Resources.

### Legislative Authority

- Federal Water Pollution Control Act Amendments of 1972, as amended, 33

## RECOMMENDATIONS FOR LIFELINE SEISMIC STANDARDS

U.S.C. 1251 *et seq.*

### Regulations

- 40 CFR (7-1-90 Edition), Ch. I, Water Pollution Control. [No specific earthquake or seismic design regulations published by EPA in CFR.]

### Standards And Guidelines

- ASCE/TCLEE, 1983, "Advisory Notes on Lifeline Earthquake Engineering."
- ASCE/TCLEE, 1984, "Guidelines for the Seismic Design of Oil and Gas Pipelines."
- ASCE/TCLEE, 1986, "Water Treatment Plant Design."
- Army TM 5-809-10, NAVFAC P-355, AFM 88-3, "Seismic Design for Buildings," Chs. 10, Mechanical and Electrical Elements; 11, Structures Other Than Buildings; 12, Utility Systems; 13; and 15.
- East Bay Municipal Utility District, Oakland, CA, "Engineering Standard Practice on Seismic Design."
- Environmental Quality Systems, 1980, "Earthquake Design Criteria for Water Supply and Wastewater Systems."

#### -- Tanks

- AWWA D100-84
- AWWA D103-87
- AWWA D110-86
- ACI-74-26
- ACI-344, "Prestressed Concrete Tanks"

#### -- Buried Pipe

- AWWA--Standards for ductile iron, steel, concrete, and asbestos cement pipe, fittings, valves, and hydrants.

#### -- Plant Piping

- ASME, "Pressure Vessel and Piping Code 31.1."
- ASPE Data Book, vol. 2, "Special Plumbing Systems Design," ch. 19, "Seismic Protection of Plumbing Equipment."
- NFPA 13, Standard for the Installation of Fire Sprinklers."

- Pipe Hangers And Supports
  - MSS SP-58
  - MSS SP-69
  - MSS SP-89
- Wells
  - National Water Well Association--No seismic design provisions in NWWA guidelines.
- Electrical equipment
  - IEEE Standard 344, "IEEE Recommended Practice for Seismic Qualification of Class 1E Equipment for Nuclear Power Generating Stations" [standard not used in water and sewage industry because standard very conservative, resulting in very high cost of equipment].
  - National Electrical Manufacturers Association--no seismic resistance provisions in equipment normally used by water and sewer industry; mitigation by anchoring per UBC.

**VII-A.7**

**APPENDIX REFERENCES**

1. California Public Utilities Commission Order 112-D.
2. 16 U.S.C. 824(a)
3. 16 U.S.C. 824(b)(1)
4. 16 U.S.C. 824a
5. 16 U.S.C. 824a-1
6. 16 U.S.C. 824a-2.
7. *Earthquake Resistant Construction of Electric Transmission and Telecommunication Facilities Serving the Federal Government Report*, FEMA-202, September 1990, Federal Emergency Management Agency, Washington, DC.
8. *Ibid.*, at pp. 21 - 22.
9. *Ibid.*, p. 38. Richard Lee, George R. Hanks, TVA.
10. *Ibid.*, pp. 23, 38. Don Russell, U.S. Army Corps of Engineers District Office, Anchorage, Alaska.
11. U.S. Department of Energy, Bonneville Power Administration, April 30, 1990, Substation

## RECOMMENDATIONS FOR LIFELINE SEISMIC STANDARDS

- and Control Engineering Criteria and Standards, Book 1, Chapter 2, Section 7, "Seismic Policy for Transferable and Fixed Equipment."
12. Ibid., pp. 22 - 23, 38. James Lloyd, Southeastern Power Administration.
  13. Ibid., pp. 24, 37. Michael E. McCafferty, Terry Burley, Don Warner, Western Area Power Administration.
  14. Ibid., pp. 25, 38. Lee A. Belfore, Rural Electrification Administration.
  15. Pacific Gas & Electric Co., Southern California Edison, and Los Angeles Department of Water and Power.
  16. Endnote 7, pp. 10, 40. Anshel J. Schiff.
  17. Anderson, Thomas L. and Bachman, Robert E. 1985. "LNG Terminal Design for California," Journal of the Technical Councils of ASCE, vol. 107, No. TC1, American Society of Civil Engineers.
  18. Endnote 7, pp. 39 - 40. John W. Foss and John Hinton, Bellcore.
  19. ATC-3-06, 1984. Tentative Provisions for the Development of Seismic Regulations for Buildings. Applied Technology Council, Redwood City, California.
  20. Frank Kozel, Senior Vice President for Facilities, MCI, oral communication.
  21. Louis Cerny, Executive Director, American Railway Engineering Association, oral communication.
  22. Robert Martin, Federal Railroad Administration, Office of Policy, oral communication.
  23. Louis Cerny, *ibid.*; Robert Martin, Federal Railroad Administration, Office of Policy, oral communication.
  24. Douglas Kerr, UMTA Grants Management, oral communication.
  25. Endnote 7, at p. 18.
  26. *Ibid.*, at p. 18.
  27. Airport and Airway Trust Fund, 26 U.S.C. 9502.
  28. U.S. Department of Transportation, Federal Aviation Administration, Airport Assurances (10-89), PP-A-1, §34.

---

## APPENDIX A: CONTRIBUTORS TO THE PLAN

---

### 1. STEERING GROUP MEMBERS

Mr. Ronald T. Eguchi, Chairman  
EQE Engineering and Design  
3150 Bristol Street, Suite 350  
Costa Mesa, CA 92626

Mr. Harold W. Andress  
FEMA  
500 C Street, SW  
Washington, DC 20472

Mr. William S. Bivins  
FEMA  
500 C Street, SW  
Washington, DC 20472

Dr. Ian Buckle  
NCEER  
SUNY/Buffalo  
Red Jacket Quadrangle  
Buffalo, NY 14261

Mr. James D. Cooper  
ICSSC  
Federal Highway Administration  
6300 Georgetown Pike  
McLean, VA 22101

Mr. Robert D. Dikkers  
NIST  
Building and Fire Research Laboratory  
Gaithersburg, MD 20899

Mr. John Foss  
Bell Communications Research  
435 South Street  
Room 1A334  
Morristown, NJ 07960

Mr. James R. Hill  
U.S. Department of Energy  
Safety and Technology Division  
Washington, DC 20585

Dr. H.S. Lew  
NIST  
Building and Fire Research Laboratory  
Gaithersburg, MD 20899

Mr. H. Crane Miller  
3401 Lowell Street, NW  
Washington, DC 20016

Dr. Douglas J. Nyman  
D.J. Nyman & Associates  
12337 Jones Road, Suite 204  
Houston, TX 77070

Dr. Masanobu Shinozuka  
NCEER  
SUNY/Buffalo  
Red Jacket Quadrangle  
Buffalo, NY 14261

Mr. James R. Smith  
National Institute of Building  
Sciences  
1201 L. Street, NW, Suite 400  
Washington, DC 20005

### ALTERNATES

Dr. George C. Lee  
SUNY/Buffalo  
412 Bonner Hall  
Buffalo, NY 14260

Mr. R. Michael McCafferty  
Western Area Power Administration  
P.O. Box 3402  
Golden, CO 80401

Dr. Michael O'Rourke  
Rensselaer Polytechnic Institute  
Troy, NY 12180-3590

---

## CONTRIBUTORS TO THE PLAN (Continued)

---

### 2. PLAN AUTHORS AND EXPERT REVIEWERS

#### Chapter II

##### Electrical Power Lifelines

##### Plan Author

Dr. Anshel J. Schiff  
27750 Edgerton Road  
Los Altos Hills, CA 94022

##### Expert Reviewers

Dr. James E. Beavers  
Corporate Fellow  
Martin Marietta Energy Systems, Inc.  
P.O. Box 2009  
Oak Ridge, TN 37831-8037

Mr. Ben Damsky  
Electrical Power Research Institute  
Safety & Technology Department  
3412 Hillview Ave.  
Palo Alto, CA 94303

Mr. Edward N. Matsuda  
Pacific Gas & Electric Co.  
Civil Engr. Dept./ Rm. F 1504A  
1 California Street  
San Francisco, CA 94106

##### Mr. Dennis Ostrom

Southern California Edison Co.  
2244 Walnut Grove Ave.  
Rosemead, CA 91770

Mr. Ronald A. Tognazzini  
Los Angeles Dept. of Water & Power  
1890 Canyon Close Rd.  
Pasadena, CA 91107

#### Chapter III

##### Gas And Liquid Fuel Lifelines

##### Plan Author

Dr. Douglas J. Nyman  
D.J. Nyman & Associates  
12337 Jones Road, Suite 204  
Houston, TX 77070

##### Expert Reviewers

Mr. Thomas L. Anderson  
Fluor Daniel Inc.  
3333 Michelson Drive  
Mail Stop 533T  
Irvine, CA 92730

Mr. Charles B. Crouse  
Dames & Moore  
500 Market Place Tower  
2025 1st Ave.  
Seattle, WA 98121

Dr. William J. Hall  
University of Illinois  
3105 Valley Brook Dr.  
Champaign, IL 61821

Mr. Peter W. McDonough  
Mountain Fuel Supply Co.  
180 E. 1st South  
Salt Lake City, UT 84139

Dr. Thomas D. O'Rourke  
Cornell Univ.  
265 Hollister Hall  
Ithaca, NY 14853



---

## CONTRIBUTORS TO THE PLAN (Continued)

---

### Chapter IV

#### Telecommunication Lifelines

##### Plan Author

Mr. Alex Tang  
2591 Pollard Drive  
Mississauga, Ontario  
CANADA, L5C 3G9

##### Expert Reviewers

Mr. Ted J. Canon  
H.J. Degenkolb Associates  
350 Sansome Street  
Suite 900  
San Francisco, CA 94104

Mr. John Foss  
Bell Communications Research  
Room 1A334  
435 South Street  
Morristown, NJ 07960

Dr. Jeremy Isenberg  
Weidlinger Assoc. Inc.  
4410 El Camino Real, Suite 110  
Los Altos, CA 94022

Dr. S. Chi Liu  
Program Director  
National Science Foundation  
1800 G Street, N.W.  
Washington, DC 20550

Dr. Masanobu Shinozuka  
NCEER  
SUNY/Buffalo  
Red Jacket Quadrangle  
Buffalo, NY 14265

Mr. Lawrence F. Wong  
Pacific Bell  
2600 Camino Ramon  
Room 3S 850  
San Ramon, CA 94583

### Chapter V

#### Transportation Lifelines

##### Plan Author

Dr. Ian Buckle  
NCEER  
SUNY/Buffalo  
Red Jacket Quadrangle  
Buffalo, NY 14261

##### Expert Reviewers

Mr. James D. Cooper  
ICSSC  
Federal Highway Administration  
6300 Georgetown Pike  
McLean, VA 22101

Mr. James H. Gates  
Caltrans Div. of Structures  
P.O. Box 942874  
Sacramento, CA 94274

Dr. Geoffery R. Martin  
Department of Civil Engineering  
University of Southern California  
Los Angeles, CA 90089

Mr. James E. Monsees

PB/MK Team  
7220 South Westmoreland Rd.  
No. 200  
Dallas, TX 75237

Dr. Stuart D. Werner  
Dames & Moore  
8601 Skyline Blvd.  
Oakland, CA 94611

---

**CONTRIBUTORS TO THE PLAN (Continued)**

---

**Chapter VI**

**Water And Sewer Lifelines**

**Plan Author**

Mr. Donald B. Ballantyne  
Kennedy/Jenks/Chilton  
530 South 336th Street  
Federal Way, WA 98003

**Expert Reviewers**

Mr. Walter F. Anton  
Seattle Water Dept.  
Dexter Horton Bldg./9th Flr.  
710 2nd Ave.  
Seattle, WA 98104

Mr. Holly A. Cornell  
Consultant  
8600 Carmel Circle  
Wilsonville, OR 97070

Mr. William M. Elliott  
Portland Water Department  
Lake Oswego, OR 97034

Mr. Le Val Lund  
Consultant  
3245 Lowry Road  
Los Angeles, CA 90027

Dr. Michael O'Rourke  
139 Arrowwood Place  
Ballston Spa, NY 12020

**Chapter VII**

**Federal Roles In Development,  
Adoption, And Implementation Of  
Seismic Design Standards For  
Lifelines**

**Plan Author**

Mr. H. Crane Miller  
3401 Lowell Street, NW  
Washington, DC 20016

**Expert Reviewers**

Dr. Harold C. Cochrane  
Department of Economics  
Colorado State University  
Ft. Collins, CO 80523

Dr. Joanne Nigg  
Director  
Disaster Research Center  
University of Delaware  
Newark, DE 19716

Dr. William J. Petak  
University of Southern California  
6044 Mossback Drive  
Rancho Palos Verdes, CA 90274

Mr. Robert A. Olson  
President  
VSP Associates, Inc.  
455 University Avenue  
Suite 340  
Sacramento, CA 95825

Mr. Craig E. Taylor  
Dames & Moore  
911 Wilshire Place  
Suite 700  
Los Angeles, CA 90017

---

## CONTRIBUTORS TO THE PLAN (Continued)

---

### 3. LIFELINES STANDARDS WORKSHOP PARTICIPANTS

Mr. Harold W. Andress  
FEMA  
500 C Street, SW  
Washington, DC 20472

Dr. T. Ariman  
College of Engr. & Applied Sciences  
University of Tulsa  
Tulsa, OK 74104-3189

Dr. Clifford Astill  
National Science Foundation  
1800 G Street, NW  
Washington, DC 20550

Ms. Sandy Auchmoody  
NIST  
Building & Fire Research Laboratory  
Gaithersburg, MD 20899

Mr. Donald B. Ballantyne  
Kennedy/Jenks/Chilton  
530 South 336th Street  
Federal Way, WA 98003

Mr. Robert J. Belecky  
Public Service Company of CO  
2701 W. 7th Avenue  
Denver, CO 80204

Mr. William S. Bivins  
FEMA  
500 C Street, SW  
Washington, DC 20472

Dr. Ian Buckle  
NCEER  
SUNY/Buffalo  
Red Jacket Quadrangle  
Buffalo, NY 14261

Mr. Ted J. Canon  
H.J. Degenkolb Associates  
350 Sansome Street  
Suite 900  
San Francisco, CA 94104

Lt. Col. Michael S. Cleary  
National Communications System  
Joint Secretariat (NCS-NJ)  
701 S. Courthouse Road  
Arlington, VA 22204

Dr. Harold C. Cochrane  
Department of Economics  
Colorado State University  
Ft. Collins, CO 80523

Mr. James D. Cooper  
Federal Highway Administration  
6300 Georgetown Pike  
McLean, VA 22101

Mr. Holly A. Cornell  
CH2M Hill  
2300 N.W. Walnut Blvd.  
PO Box 428  
Corvallis, OR 97339

Dr. Charles B. Crouse  
Dames & Moore  
500 Market Place Tower  
2025 1st Ave.  
Seattle, WA 98121

Mr. Ben Damsky  
Electrical Power Research Institute  
Safety & Technology Department  
3412 Hillview Ave.  
Palo Alto, CA 94303

Mr. Robert D. Dikkers  
NIST  
Building & Fire Research Laboratory  
Gaithersburg, MD 20899

Mr. Steven Dreyer  
Pacific Gas & Electric Co.  
Rm H1002  
123 Mission Street  
San Francisco, CA 94106

---

**CONTRIBUTORS TO THE PLAN (Continued)**

---

Mr. Ronald T. Eguchi  
EQE Engineering and Design  
3150 Bristol Street, Suite 350  
Costa Mesa, CA 92626

Mr. William M. Elliott  
Portland Water Department  
2250 Park Road  
Lake Oswego, OR 97034

Mr. John Foss  
Bell Communications Research  
435 South Street  
Room 1A334  
Morristown, NJ 07960

Mr. James H. Gates  
Caltrans Div. of Structures  
P.O. Box 942874  
Sacramento, CA 94274

Ms. Laurel Harrington  
Seattle Water Dept.  
Dexter Horton Bldg./9th Flr.  
710 2nd Ave.  
Seattle, WA 98104

Mr. James R. Hill  
U.S. Department of Energy  
Safety and Technology Division  
Washington, DC 20585

Dr. Jeremy Isenberg  
Weidlinger Assoc. Inc.  
4410 El Camino Real, Suite 110  
Los Altos, CA 94022

Mr. Edwin Jones  
American Society of Civil Engineers  
345 East 47th Street  
New York, NY 10017

Mr. Gerald J. Klaus  
Public Service Company of CO  
2701 West 7th Avenue  
Denver, CO 80204

Dr. H.S. Lew  
NIST  
Building & Fire Research Laboratory  
Gaithersburg, MD 20899

Mr. Le Val Lund  
3245 Lowry Road  
Los Angeles, CA 90027

Dr. Geoffery R. Martin  
Department of Civil Engineering  
University of Southern California  
3620 S. Vermont Ave, KAB-Rm 210  
Los Angeles, CA 90089

Mr. Edward N. Matsuda  
Pacific Gas & Electric Co.  
Civil Engr. Dept./ Rm. F 1504A  
1 California Street  
San Francisco, CA 94106

Mr. R. Michael McCafferty  
Western Power Administration  
P.O. Box 3402  
Golden, CO 80401

Mr. Peter W. McDonough  
Mountain Fuel Supply Co.  
180 E. 1st South  
Salt Lake City, UT 84139

Mr. Jack D. McNorgan  
Southern California Gas Co.  
M.L. 730C, Box 3249  
Los Angeles, CA 90051-1249

Mr. H. Crane Miller  
3401 Lowell Street, NW  
Washington, DC 20016

Dr. James E. Monsees  
PB/MK Team  
7220 South Westmoreland Rd.  
No. 200  
Dallas, TX 75237

---

**CONTRIBUTORS TO THE PLAN (Continued)**

---

Dr. Joanne Nigg  
Disaster Research Center  
University of Delaware  
Newark, DE 19716

Dr. Douglas J. Nyman  
D.J. Nyman & Associates  
12337 Jones Road, Suite 204  
Houston, TX 77070

Mr. Robert A. Olson  
VSP Associates, Inc.  
455 University Avenue  
Suite 340  
Sacramento, CA 95825

Dr. Michael O'Rourke  
Rensselaer Polytechnic Institute  
139 Arrowwood Place  
Ballston Spa, NY 12020

Dr. Thomas D. O'Rourke  
Cornell University  
265 Hollister Hall  
Ithaca, NY 14853

Mr. Joseph Pavlus  
AMOCO Pipeline  
One Mid-America Plaza  
Suite 200  
Oak Brook Terrace, IL 60181

Dr. William J. Petak  
University of Southern California  
Inst of Safety & System Mgmt  
Los Angeles, CA 90089-0021

Dr. William U. Savage  
Pacific Gas & Electric Co.  
Room 760  
215 Market Street  
San Francisco, CA 94106

Dr. Anshel J. Schiff  
Stanford University  
27750 Edgerton Road  
Los Altos Hills, CA 94022

Mr. Richard Shaw  
International Safety Systems  
16270 Raymer Street  
Van Nuys, CA 91406

Dr. Masanobu Shinozuka  
NCEER  
SUNY/Buffalo  
Red Jacket Quadrangle  
Buffalo, NY 14261

Mr. Alex Tang  
Northern Telecom Canada Ltd.  
2591 Pollard Drive  
Mississauga, Ontario  
CANADA, L5C 3G9

Dr. Craig E. Taylor  
Dames & Moore  
911 Wilshire Place  
Suite 700  
Los Angeles, CA 90017

Mr. George O. Thomas  
Department of Energy  
Western Area Power Administration  
PO Box 3402  
Golden, CO 80401

Mr. Ronald A. Tognazzini  
Los Angeles Dept. of Water & Power  
1890 Canyon Close Rd.  
Pasadena, CA 91107

Dr. Stuart D. Werner  
Dames & Moore  
2101 Webster St., Suite 300  
Oakland, CA 94612

Mr. Lawrence F. Wong  
Pacific Bell  
2600 Camino Ramon  
Room 3S800  
San Ramon, CA 94583



---

**APPENDIX B**  
**AGENDA - LIFELINES STANDARDS WORKSHOP**

---

**Embassy Suites, Denver, CO, September 25-27, 1991**

**WEDNESDAY, SEPTEMBER 25, 1991--SESSION I - REMINGTON A**

- 1:00 p.m.            **Registration**
- 1:30 p.m.            **Welcome & Opening Remarks**
- Mr. Robert D. Dikkers, Workshop Chairman, NIST
  - Mr. William S. Bivins, FEMA
  - Dr. H.S. Lew, NIST
  - Dr. Ronald Eguchi, Chairman, Steering Group
- 1:45 p.m.            **Electrical Power Systems - Dr. Anshel J. Schiff**
- 2:15 p.m.            **Gas and Liquid Fuel Systems - Dr. Douglas J. Nyman**
- 2:45 p.m.            **Telecommunication Systems - Mr. Alex Tang**
- 3:15 p.m.            **Break**
- 3:30 p.m.            **Transportation Systems - Dr. Ian Buckle**
- 4:00 p.m.            **Water and Sewer Systems - Mr. Donald B. Ballantyne**
- 4:30 p.m.            **Federal Regulation & Implementation - Mr. Crane Miller**
- 5:00 p.m.            **General Discussion of Draft Plans**
- 5:30 p.m.            **Priorities for Standards Development & Research**
- 5:45 p.m.            **Adjourn Session I**
- 7:00 p.m.            **Workshop Dinner - REMINGTON B**

---

## **AGENDA - LIFELINES STANDARDS WORKSHOP (Continued)**

---

### **THURSDAY, SEPTEMBER 26, 1991--SESSION II**

- 8:30 a.m.            **Convene Breakout Meetings**
- **Electrical Power**
  - **Gas and Liquid Fuel**
  - **Telecommunications**
  - **Transportation**
  - **Water and Sewer**
  - **Federal Regulation & Implementation**
- 10:00 a.m.           **Break (Individual Breakout Rooms)**
- 10:30 a.m.           **Continue Breakout Meetings**
- 12:00 p.m.           **Workshop Lunch - Fountain Area**
- 1:00 p.m.            **Discussion of Federal Implementation**
- 2:00 p.m.            **Continue Breakout Meetings**
- 3:30 p.m.            **Break (Individual Breakout Rooms)**
- 4:00 p.m.            **Continue Breakout Meetings**
- 5:30 p.m.            **Adjourn Session II**



---

## **AGENDA - LIFELINES STANDARDS WORKSHOP (Continued)**

---

### **FRIDAY, SEPTEMBER 27, 1991--SESSION III - REMINGTON A**

- 8:30 a.m.                    **Presentation of Breakout Meeting Discussions (15 Minutes Each)**
- **Electrical Power Systems - Dr. Anshel J. Schiff**
  - **Gas and Liquid Fuel Systems - Dr. Douglas J. Nyman**
  - **Telecommunication Systems - Mr. Alex Tang**
  - **Transportation Systems - Dr. Ian Buckle**
  - **Water and Sewer Systems - Mr. Donald B. Ballantyne**
  - **Federal Regulation & Implementation - Mr. Crane Miller**
- 10:00 a.m.                    **Break**
- 10:15 a.m.                    **Open Discussion on Lifelines Draft Plans**
- 11:00 a.m.                    **Open Discussion on Federal Regulation & Implementation**
- 11:45 a.m.                    **Priorities for Standards Development & Research**
- 12:00 p.m.                    **Closing Remarks**
- 12:15 p.m.                    **Adjourn Workshop**

