

NISTIR 5888

Materials Aspects of Fiber-reinforced Polymer Composites in Infrastructure

Joannie W. Chin

August 1996
Building and Fire Research Laboratory
National Institute of Standards and Technology
Gaithersburg, MD 20899



National Institute of Standards and Technology
Michael Kantor, *Secretary*
Technology Administration
Mary L. Good, *Under Secretary for Technology*
National Institute of Standards and Technology
Arati Prabhakar, *Director*

ABSTRACT

This paper provides a review of the technical literature pertaining to materials aspects of fiber-reinforced polymer (FRP) composites in infrastructural and other civil engineering applications. The main focus is placed upon the durability, chemical and mechanical aspects of structures reinforced with or constructed from FRP materials. Categories which are addressed include marine applications, structural shapes, joining/fastening, reinforced concrete and rehabilitation/retrofitting of structures. Effects of moisture, salt water, alkalinity and mechanical loading on the performance of FRP components are emphasized.

Keywords: polymer composites, construction, civil engineering, infrastructure, fibers, durability, rehabilitation, retrofitting

TABLE OF CONTENTS

	<u>Page</u>
I. Introduction	1
II. Comparison of Properties: FRP versus Traditional Building Materials	2
III. Marine and Offshore Applications	4
IV. Structural Applications	7
V. Concrete Reinforcement	11
VI. Rehabilitation and Retrofitting of Existing Structures	18
A. Concrete	20
B. Steel	28
C. Timber	28
D. Column Wrapping	30
E. Masonry	31
VII. Joining/Fastening of Composite Components	31
VIII. Conclusions	34
IX. References	35

LIST OF FIGURES

	<u>Page</u>
Figure 1: Water uptake curves for graphite/vinyl ester composites in seawater at 1 atmosphere and at 2000 feet of seawater [20].	6
Figure 2: Changes in the flexural moduli of polyester/epoxy, glass/epoxy, carbon/epoxy and glass/polyester composites as a function of absorbed moisture [23].	8
Figure 3: Creep deflection and recovery data for the midspan and column of a pultruded FRP frame [32].	9
Figure 4: Bending moment versus deflection for various types of concrete beams reinforced with FRP rebar, compared to beams reinforced with steel rebar [31].	13
Figure 5: Test set-up for direct pull-out testing of FRP rebar in concrete [52].	15
Figure 6: Bond strength as a function of freeze/thaw cycles for glass fiber-reinforced rebar [51].	16
Figure 7: Changes in ultimate capacity as a function of exposure for uncracked and precracked FRP rebar reinforced concrete exposed to sea water, compared with the unexposed controls. [62].	19
Figure 8: G_{IC} and G_{IIC} values obtained from peel testing for concrete/composite bonds exposed to air, water, seawater, freezing and freeze/thaw conditions [68].	22
Figure 9: Comparison of damaged concrete beam properties with properties of beams repaired with composite plates [72].	23
Figure 10: Method of concrete reinforcement with pretensioned FPR sheets: (a) Prestressing of FRP sheet, (b) Curing of adhesive, and (c) Release of FRP ends [73].	25
Figure 11: Load/displacement curves for concrete beams externally reinforced with prestressed carbon FRP, (Beams A through D), compared to the control beam (E) with no FRP reinforcement [73].	26
Figure 12: Plot of load versus midspan deflection for various beams: All beams are reinforced with standard steel rebar, except for S1, which is reinforced with twice the steel reinforcement of the others. Beams A3, E3 and G3 are reinforced with aramid, glass and graphite fabrics respectively [74].	27
Figure 13: Crack lengths for steel/composite wedge specimens after 7 days in various environments [78].	29

Introduction

As the deterioration of the world's infrastructure continues at an alarming rate, it becomes increasingly urgent to determine the feasibility of utilizing high performance polymer composite materials for the fabrication of new structures as well as for retrofitting existing ones. It is currently estimated that almost half of the 576,665 highway bridges in the U.S. are either structurally deficient or functionally obsolete and repair costs are estimated to start at \$90 billion^{1,2}. Total repair costs for corroded steel and concrete structures in the U.S. exceed \$250 billion dollars per year. Additional repair and retrofitting costs for seismically deficient structures, deteriorating civil and military waterfronts and substandard transportation infrastructure run into additional billions of dollars annually².

In light of these sobering statistics, the Civil Engineering Research Foundation (CERF) has recommended the use of high performance materials and systems in construction, citing potentially substantial cost savings due to lower volumes of materials needed, reduced maintenance and longer lifetimes³. The advantages that composites offer over traditional building materials such as steel and concrete have been widely recognized and include a high strength/weight ratio, excellent corrosion and chemical resistance, transparency to electromagnetic radiation and resistance to fatigue.

The use of composite materials in construction began with the use of timber, plywood, straw-reinforced clay, iron-reinforced pozzolanic cement concrete and steel-reinforced concrete⁴. However, the use of fiber-reinforced polymer composites in construction has been limited up until now, due partly to a lack of knowledge among designers and engineers concerning the behavior of these materials. This is particularly true in terms of long-term performance and reliability. Differences between the mechanical properties of FRP and conventional building materials are another barrier to more widespread use.

In contrast to the plethora of work originating from the aerospace and military arena on durability of composites, there is a small but growing body of research which is specifically concerned with FRP performance and durability in building and construction applications. This trend parallels the increase in the use of composites in the construction

market: 271 million kg (597 million pounds) of composite were shipped in 1994 for use in construction, a 12% increase over 1993⁵. This review summarizes recent research on the chemical and mechanical aspects of FRP in structural shapes, marine and offshore structures, concrete reinforcement, rehabilitation/retrofitting of existing structures and joining/fastening. The focus of this paper is on experimental results as opposed to simulation or computer modeling of composite behavior; further emphasis is given to results published in the last five years. A brief discussion of the differences between FRP properties compared to more traditional construction materials is also presented here.

Comparison of Properties: FRP versus Traditional Building Materials

Due to the wide range of properties which are available in both fibers and matrices, an almost endless range of fiber/polymer combinations can be achieved. Fibers can be produced from a variety of materials (e.g. glass, carbon, aramid), have a wide range of strengths and stiffnesses, and can be incorporated into a number of forms, such as woven fabrics, tows or rovings. The percentage of composite volume taken up by the fiber as well as its orientation profoundly affects the mechanical properties of the resulting material⁶.

The polymer matrix can also be modified to obtain a wide range of physical properties. The incorporation of additives, such as mineral fillers, plasticizers and other performance-enhancing additives, can affect mechanical performance, diffusion characteristics and hygrothermal resistance of the composite. The quantity of curing agents, promoters and accelerators used also has an impact on the final properties of the matrix phase⁶. Another issue which cannot be overlooked is the degree of interfacial bonding between the fiber and matrix, which is critical in transferring loads to and between the fibers so that the full strength potential of the fibers can be developed⁷.

Processing variables, such as heating and cooling rates, cure temperature and cure time, have an effect on the degree of cure and hence the chemistry of the composite material. Void volume in a composite component is a function of the compaction and consolidation which took place during cure. A high degree of compaction serves to

eliminate voids and non-wetted fibers in the composite laminate, which could serve as potential stress concentrations for future damage ⁶.

Laminates which are unidirectionally reinforced with high performance fibers generally exhibit linear-elastic behavior to failure, depending on the direction of the applied stress with respect to the fiber direction. Unidirectionally-reinforced glass/epoxy laminates have tensile strength and modulus greater than wood, steel, aluminum or concrete ⁸. Unidirectionally reinforced carbon fiber/epoxy laminates have specific tensile strengths (ratio of tensile strength to material density) approximately 4-6 times greater and specific modulus (ratio of modulus to material density) 3.5-5 times greater than that of steel or aluminum ⁹. However, FRP materials also do not possess a high degree of ductility and exhibit very little yielding prior to failure. In terms of fatigue, most FRP materials do not exhibit a fatigue limit. It also has been observed that high frequency stress cycling can generate internal heat which is not readily dissipated ¹⁰.

Because of the viscoelastic nature of polymeric materials, time-dependent effects are present in fiber-reinforced composites which do not occur in traditional building materials. FRP materials have a greater tendency than steel or concrete to undergo creep under sustained long-term loading ⁶. Thus, the apparent stiffness and strength of the FRP will decrease slowly over time. In addition, the stiffness and strength of an FRP material is dependent on the *rate* of loading. The extent to which these phenomena will occur depends on the specifics of the polymer type and stress history, alignment/type/volume fraction of reinforcement, environmental temperature and humidity. The time temperature superposition (TTSP) principle has been successfully utilized in extrapolating short-term creep data over many decades in time; a detailed treatment of this technique can be found in many polymer science texts ^{11,12}.

The coefficient of thermal expansion for glass fiber-reinforced composite is comparable to aluminum alloys, but higher than steel and concrete ⁵. Corrosion properties are often cited as being superior to metals which oxidize and rust, but the resin matrix component of an FRP does absorb moisture, as do aramid reinforcing fibers. There is also evidence that glass fibers have a tendency to degrade in the presence of moisture ¹³. Ultraviolet exposure, while not having any significant effect on the properties of steel or

concrete, does erode organic matrices over time¹⁴. The interaction of time, temperature, mechanical stress and other weathering conditions such as moisture, UV, and freeze/thaw cycling affects the structural performance of FRP to a greater extent than any other building material (with the possible exception of wood)⁶.

Marine and Offshore Applications

Surface ships and submarines aside, marine applications of FRP primarily involve offshore platform components, docks and piers. In offshore applications, FRP materials have been used for tension leg platforms, tether lines, risers, cables, tubing and drill pipes^{15,16}. Glass, carbon, aramid and combinations of these fibers are commonly used to reinforce epoxy or vinyl ester resins for these applications. The primary problem resulting from the use of conventional materials such as steel in marine environments is corrosion, not only from salt water, but from other corrosive agents such as hydrogen sulfide, carbon dioxide and chlorides. Other environmental factors to be considered in a marine environment are the combined effects of moisture, salt, temperature and ultraviolet (UV) radiation¹⁷. High hydrostatic pressures which are encountered at great depths (13-21 MPa) also complicate the prediction of long-term durability.

Sea water is an aggressive agent in the degradation of FRP. Glass fiber reinforcement, in particular, is subject to attack by water⁹. Graphite or carbon fibers are less susceptible to sea water degradation but are electrically conductive and hence can initiate electrochemical reactions in the presence of an electrolyte such as salt water, resulting in fiber dissolution and matrix oxidation¹⁸. In terms of simple fluid exposure, the mechanical properties of composites which have been shown to be impacted are the tensile, compressive and shear strength/modulus, fracture toughness, damage tolerance, fatigue resistance and creep life¹⁹.

Letton and Bradley utilized transverse tensile testing to study the degradation of two types of graphite/epoxy composite immersed in sea water, and subjected to zero and 24.1 MPa (3500 psi) hydrostatic pressure. It was observed that specimens which were saturated with sea water showed a shift in the locus of failure from within the matrix

(cohesive failure) to between the fiber/matrix interface (interfacial failure). No significant differences in water uptake were observed between the non-pressurized and pressurized samples. Moisture absorption in various polycarbonates were also monitored. Much less absorption was observed in comparison to the epoxies, most likely due to a lower concentration of hydrogen bonding sites in polycarbonate¹⁶.

Vinyl ester/graphite composites were immersed in seawater by Tucker and Brown at 101 MPa (1 atmosphere) as well as at the pressure imposed at a depth of 914 meters (2000 feet). Samples subjected to the higher hydrostatic pressure were found to have a higher equilibrium moisture content than the non-pressurized samples, as shown in Figure 1. However, diffusion coefficients at the two different pressures were roughly equal in both cases²⁰. It was speculated that the higher pressure will drive moisture via capillary flow into the fiber/matrix interface, cracks and voids. It has also been postulated that hydrostatic pressure may also redistribute the free volume of the polymer so as to change the equilibrium uptake¹⁶. Samples which were exposed to higher pressure also exhibited greater decreases in flexural strength and modulus compared to samples held in the non-pressurized environment.

Data on the absorption of pressurized sea water by a carbon fiber-reinforced epoxy was reported by Kosuri and Weitsman. Both dry and pre-saturated coupons underwent fatigue cycling in air and in sea water. Dry coupons tested in air exhibited a shorter fatigue life than pre-saturated specimens in air, but longer lifetimes than the pre-saturated specimens fatigued in sea water. Separate experiments also confirmed that water was transported through transverse matrix cracks which resulted from fatigue testing. Ingress of water via this mechanism proceeded at a rate of about 1 mm per minute²¹.

Rege and Lakkad tested compressive, flexural and interlaminar shear strengths of graphite/epoxy laminates immersed in salt water and distilled water for 120 hours at various temperatures. The data showed a decrease in strength with increasing temperature for both solutions. It was also observed that, for coupons immersed in fresh and salt water at the same temperature, greater decreases in strength and higher equilibrium uptake occurred with the salt water. Water was also observed to accumulate at the fiber/matrix interface²². Similar results were obtained by Adams and Singh for epoxy reinforced with

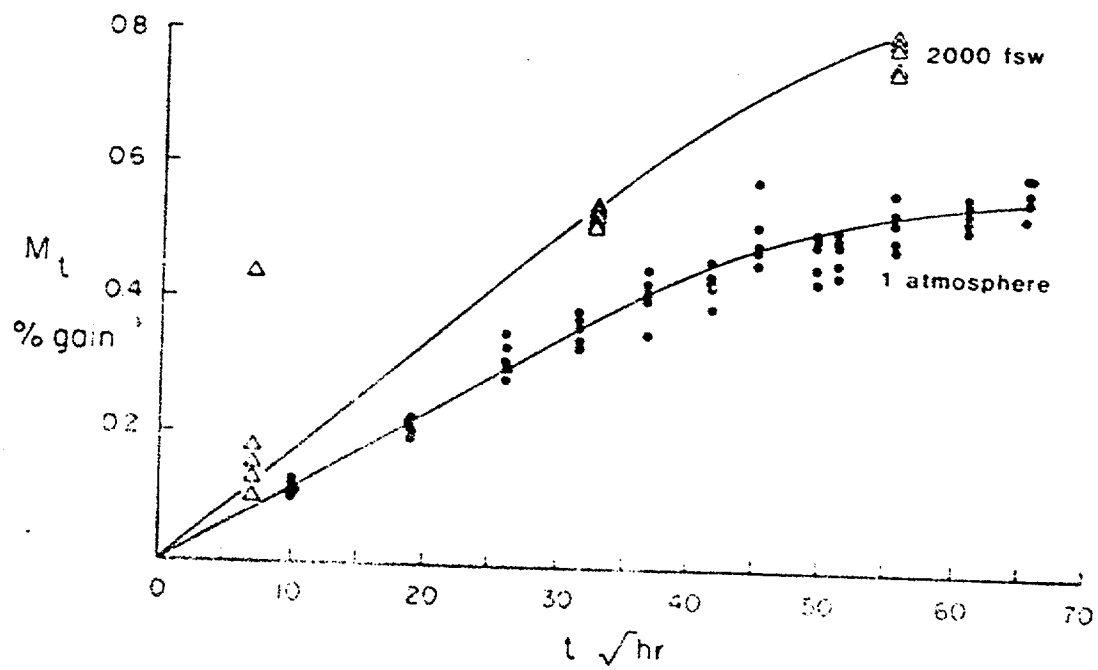

Figure 1: Water uptake curves for graphite/vinyl ester composites in seawater at 1 atmosphere and at 2000 feet of seawater [20].

glass, carbon and polyester fibers, where specimens immersed in sea water at 10°C and 20°C for 15 months exhibited decreases in stiffness at both temperatures. The data for the 20°C immersion is illustrated in Figure 2. Absorption of water in polyester fibers and at the fiber/matrix interface was believed to be due to non-Fickian diffusion kinetics in the fiber-reinforced materials²³.

Future research in this area should involve development of new materials specifically tailored for marine applications, as recommended by Springer¹⁹. A number of analytical methods have been developed for estimating temperature distribution, moisture content/distribution and hygrothermal deformations/stresses, however, the use of these models require knowledge of a specific material's thermal conductivity, diffusivity, tensile and compressive strength/moduli, dynamic and damping characteristics, and a large number of other physical and mechanical parameters¹⁹. Other critical areas of research in marine materials are identified as diffusion kinetics of sea water under hydrostatic pressure, degradation of properties due to absorption of sea water, biofouling and the joining/connection technology^{16,24}.

Structural Applications

The use of FRP in load-bearing structural components has been showcased in a number of demonstration projects within the last several years. Buildings for containment of electrical/electronic equipment, landing pads for helicopters, pedestrian bridges, bridge decks and cooling towers are a few of the examples which have been recently documented^{25,26,27,28,29}. Other potential structural uses for FRP include cables, parking garages, chemical plants and waste-water treatment facilities^{30,31}. Structural shapes which are currently used are primarily prismatic sections produced by pultrusion. There has been limited use of these members thus far due to their low stiffness and strength and high creep and stress relaxation relative to conventional materials³⁰.

Mosallam and Bank tested a wide flange pultruded glass/vinyl ester beam under 4 point creep loading for 10,000 hours, after which creep recovery data was recorded for 1000 hours. It was observed that a significant amount of creep occurred within the first 2000 hours, as shown in Figure 3. Good correlation was found between creep parameters

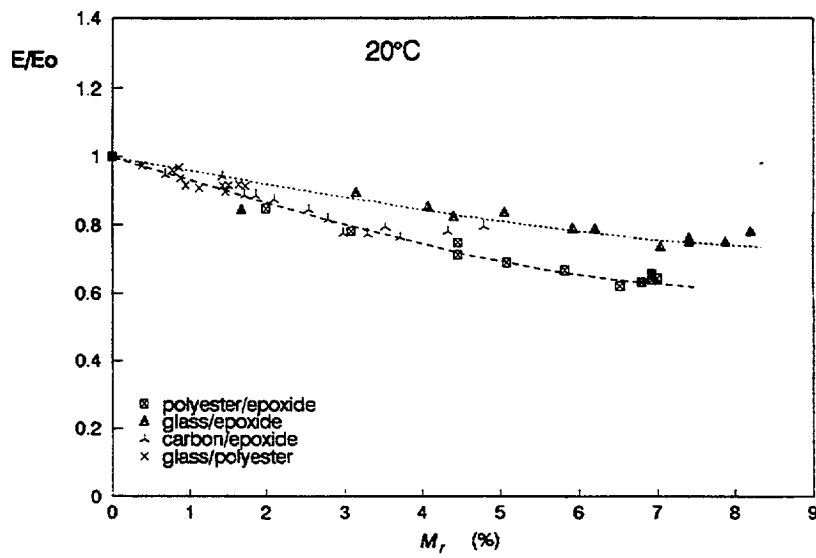

Figure 2: Changes in the flexural moduli of polyester/epoxy, glass/epoxy, carbon/epoxy and glass/polyester composites as a function of absorbed moisture [23].

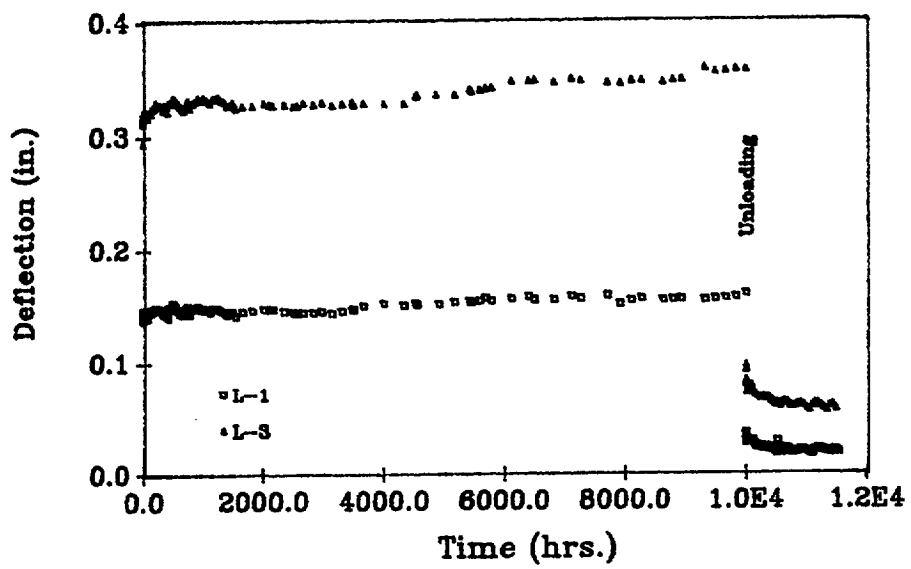

Figure 3: Creep deflection and recovery data for the midspan and column of a pultruded FRP frame [32].

of small coupons tested for 2000 hours and the behavior of the larger sections ³².

Pultruded glass-reinforced box beams were similarly subjected to creep loading by Holmes and Rahman. Data collected for 20 months could be extrapolated to longer periods; the majority of deflection was observed to occur in the first 1000 hours ³³. A comprehensive review of the creep response of composite materials is presented in the report by Scott et al. ³⁴.

Herzog et al. studied the flexural, tensile and fatigue properties of vinyl ester, isophthalic polyester, orthophthalic polyester and hybrid laminates. It was concluded that resin type played a minor role in static properties, but a major role in fatigue. Vinyl ester performed the best in high stress tensile fatigue tests, while the hybrid laminate was superior in high stress flexural fatigue, low stress tensile and flexural loads ³⁵.

Mottram measured the in-plane compressive strengths of pultruded glass/isophthalic polyester sheet using a non-ASTM compression test method. A large amount of scatter was seen in the data, which led the author to warn that disregarding this inherent variability of composite mechanical properties could lead to structures which are either prone to failure or overdesigned and hence uneconomical ³⁶.

Glass/vinyl ester and glass/isophthalic polyester gratings were subjected to acoustic emission testing by Berg and Mayfeld. The use of acoustic emission allowed the microcracking in the grating to be detected under load. More acoustic emission was observed on the tension side of the bar compared to the compressive side, and each resin formulation exhibited its own acoustic emission patterns. Vinyl ester was found to be capable of withstanding more strain than the isopolyester formulation prior to the onset of microcracking ³⁷.

The use of FRP piping for oil and gas production is on the rise, due to the need for low cost, corrosion-resistant materials. Aging oil fields, new fields with aggressive fluids, and enhanced oil recovery methods have a tendency to aggravate the corrosion of carbon steel pipes used for flow lines, water injection lines and oil gathering lines. As a field ages, the concentrations of water and hydrogen sulfide in the oil phase tend to increase, while the challenges of new fields include more aggressive fluids, deep water and/or extremely cold environments. Enhanced oil recovery techniques utilize water or

CO₂ injection, both of which corrode the currently used pipeline materials^{38,39}. The reinforcing fiber for composite pipes is limited to glass at the moment due to its superior strength/cost ratio. Anhydride-cured epoxies are utilized in flow lines and water injection systems, whereas oil gathering lines are fabricated from vinyl ester. Aromatic amine-cured epoxies have been shown to be capable of surviving 25 years in sour oil and brine³⁸. It was observed that failure due to chemical degradation was rare when a chemically resistant inner lining was used; without a inner lining, deterioration in the composite of up to 3 mils could be detected after 10 years. On above-ground piping, damage from UV exposure was also observed³⁸.

Utilizing composite components in bridge construction is extremely attractive, due to their light weight and corrosion resistance. Erki et al. carried out static and dynamic testing on a glass/vinyl ester vehicular bridge, constructed from pultruded channel and tube sections. The structure was subjected to concentrated point loading as well as to excitation by an instrumented hammer designed to simulate a single wheel load. Overall, the composite bridge structure was found to be very stiff and deflections which were observed were small⁴⁰.

McCormick applied 1.6 million loading cycles in flexure to a 4.9 m (16 ft.) glass/polyester bridge to study its fatigue characteristics. Cracks in bonded joints were observed which decreased the bridge stiffness, but did not affect the load capacity. A minor amount of creep was also observed to occur during loading, and 32 months of outdoor exposure had no apparent adverse effect on subsequent performance⁴¹. At the Swiss Federal Laboratories for Materials Testing and Research (EMPA), carbon-reinforced epoxy cables for use in cable-stayed bridges were evaluated by Meier and coworkers. The FRP cables exhibited higher stress amplitudes and higher mean stresses than steel for 2×10^6 cycles, without observable damage⁴².

Concrete Reinforcement

Steel reinforcing bars (rebars) for strengthening concrete have traditionally been fabricated from mild steel. Rebar allows a concrete structure to carry higher loads by

bearing the majority of the tensile stresses imposed on the structure. However, the corrosion of mild steel initiated by deicing salts and other chemicals used on roadways can be quite extensive and can ultimately lead to damage in the concrete structure. There are also a number of structures which cannot contain steel due to their proximity to apparatus which is sensitive to electromagnetic interference.

Pultruded FRP rebar is currently being evaluated as a substitute for steel rebar in concrete⁴³. Fibers under consideration for use in FRP rebar are glass and aramid, with carbon lagging behind due to its cost⁴⁴. Vinyl ester and isophthalic polyester resins, which have good resistance to alkali and saline environments, are typical matrix materials. Additives such as antimony trioxide and alumina hydrate are used to improve fire retardancy and UV resistance⁴⁵.

Tensile testing results show linear stress-strain behavior for composite rebar up to approximately 95% of ultimate strength⁴⁴. This elastic behavior is in contrast to the ductile characteristics exhibited by steel rebar and must be taken into account during design. For instance, concrete reinforced with composite rebar cannot sustain the same strains as steel-reinforced concrete, and the composite rebar will snap as opposed to yielding⁴⁶. FRP rebar possesses higher tensile strength, but only about one-quarter of the modulus of conventional steel. The actual tensile strength and stiffness is strongly dependent on the type of fiber used⁴⁷. Bending tests performed on concrete beams reinforced with FRP rebar show improved ductility relative to steel-reinforced beams, depicted in Figure 4. However, deflections which occur after initial concrete cracking are larger in the case of FRP rebar, due to their lower stiffness as compared to steel⁴⁴. Creep and stress relaxation in composite rebar may also have an impact on the long term deflection of concrete structures⁴⁵.

Parameters critical to the performance of FRP rebar are static short-term tensile strength, stress-rupture strength, fatigue strength and strength retention in aggressive environments such as 65% relative humidity at 20°C and highly alkaline concrete pore solution⁴⁸. Mechanical testing of rebar can be complicated by the issue of gripping the ends of the bars in the testing machine. Researchers at West Virginia University have developed sand-coated grips which transfer the load uniformly and gradually from the test

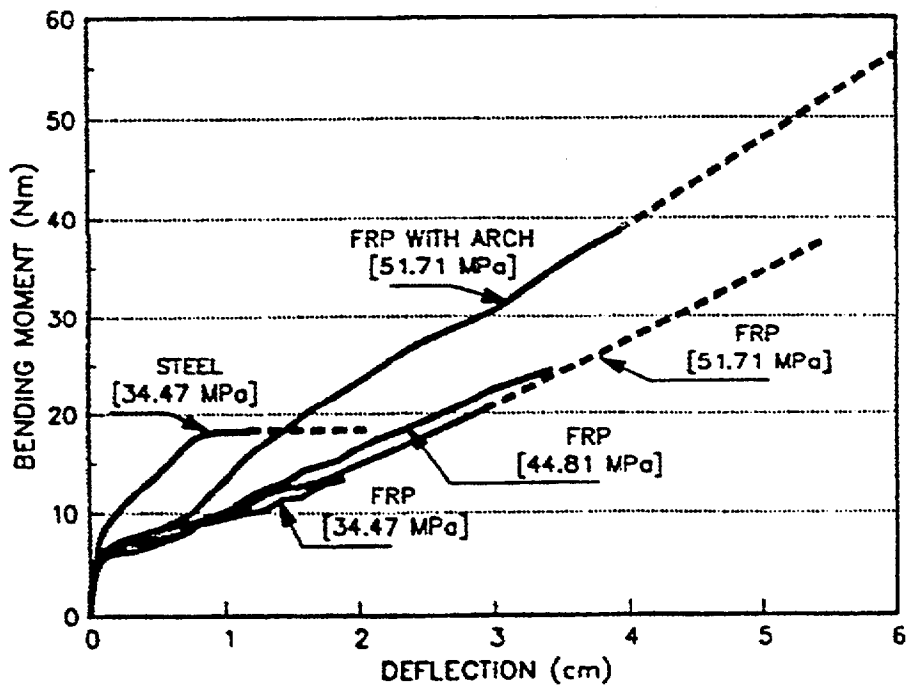

Figure 4: Bending moment versus deflection for various types of concrete beams reinforced with FRP rebar, compared to beams reinforced with steel rebar [31].

machine to the specimen, to ensure that failure does not initiate in the grip region ⁴⁴. A recent report by Nanni et al. reviews test methods for polymer composite-reinforced concrete and emphasizes the need for a better understanding of the load transfer mechanism between the composite rebar and the concrete ⁴⁹. Other test methods and devices are described by Scheibe and Rostasy ⁴⁸ and Boyle and Karbhari ⁵⁰. One type of pull-out test developed by Nanni and coworkers is illustrated in Figure 5.

The bond strength between the rebar and concrete strongly determines the strength of the reinforced structure. Roughening the surface of the FRP rebar and/or coating it with sand have been observed to improve the bond strength ⁴⁴. Wrapping of fiber bundles around the bar in a spiral configuration is another technique used to create additional surface area for mechanical interlocking ⁴⁵. Mashima and Iwamoto investigated adhesion between concrete and FRP rebar with varying engineered surfaces. The bond strengths of sand-coated, strand, coiled and braided FRP rebar embedded in concrete block was tested after 200 freeze/thaw cycles. The highest initial strength was shown by the sand-coated carbon FRP rebar and no significant changes in bond strength were observed after the freeze/thaw cycling was completed, as shown in Figure 6 ⁵¹.

Nanni et al. observed that the critical parameters affecting the pull-out strength of glass/vinyl ester, carbon/vinyl ester and carbon/epoxy rods were the composition of the resin-rich surface layer and topography of the rod itself. Bond strength was concluded to be controlled more by mechanical interlocking than actual adhesion and friction ⁵². The bond strength at transfer between FRP rebar and concrete was found by Issa et al. to be superior to that of steel rebar; however, the long-term deterioration in FRP rebar was observed to be proportionally greater ⁵³.

Rossetti et al. studied the tensile and bond behavior of glass-reinforced rebar of varying surface texture and rod diameter ⁵⁴. It was found that the bond strength between the FRP rebar and concrete was inferior to that of plain (smooth) steel rebar and concrete. An analytical model which described the stress-slip relationships between the FRP rebar and concrete was developed, and was used to calculate the embedment length of rebar in concrete. The observation that the FRP rebar exhibited virtually no plastic yielding led to the recommendation that a safety factor of greater than or equal to 2 be used in design.

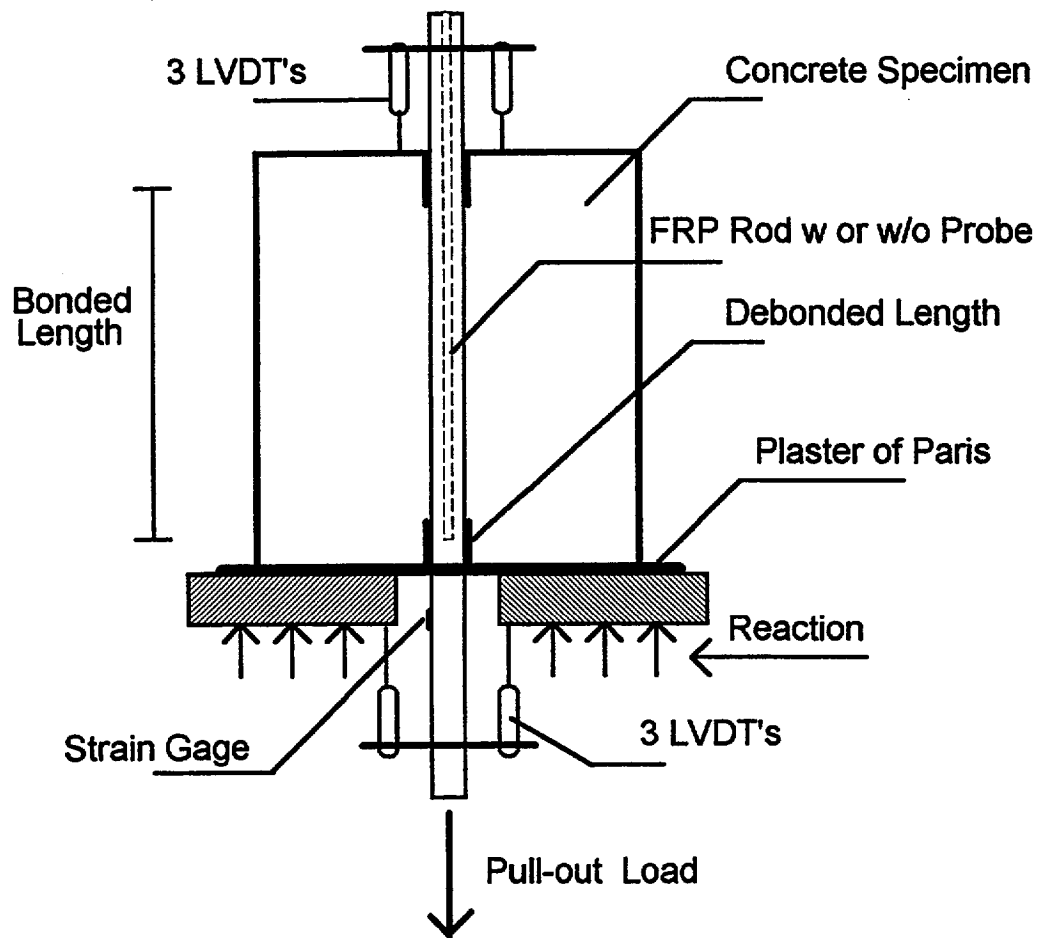

Figure 5: Test set-up for direct pull-out testing of FRP rebar in concrete [52].

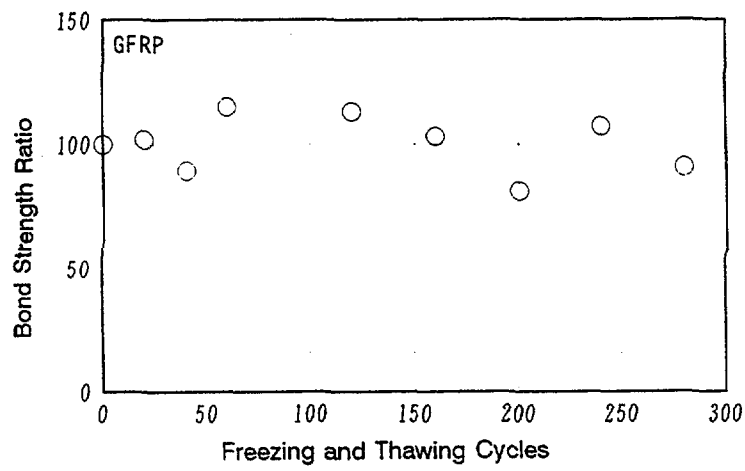

Figure 6: Bond strength as a function of freeze/thaw cycles for glass fiber-reinforced rebar [51].

However, Sen et al. observed greater maximum deflection as well as accelerated deflection beyond cracking in FRP-pretensioned concrete prior to failure and stated that properly engineered FRP-reinforced beams could provide adequate warning prior to failure ⁵⁵.

In concrete, the surface of the FRP bar will be in contact with alkaline pore solution with pH greater than 12. Calcium, sodium and potassium ions found in the pore solution are highly aggressive toward aramid and glass fibers and can reduce the stress rupture strength of the FRP rebar. Cation transport can proceed through matrix cracks, fiber/matrix interface, and matrix diffusion. However, it has been suggested that immersion in alkaline solutions may not accurately simulate the concrete environment and will yield different results than embedment in actual concrete ^{56,57}. Electron probe microscopy was used to track ingress of sodium cations into aramid, carbon and glass-reinforced vinyl ester rods by Katsuki and Uomoto. Sodium penetration occurred radially with time, and occurred to the greatest extent with the glass-reinforced rods. The glass-reinforced FRP also exhibited a decrease in tensile strength from 1690 to 480 MPa following exposure ⁵⁸.

Gerritse and Den Uijl tested aramid-reinforced prestressing tendons in a pH 13 environment under creep loading, at ambient temperature and at 60°C. It was found that the stress rupture time was much shorter in the 60°C environment than in the 20°C exposure, and greater stress relaxation was observed to occur in the alkaline solution than in air ⁵⁷. Scheibe and Rostasy subjected aramid-reinforced rods to stress-rupture testing at various temperatures both in air as well as in an alkaline environment. FRP specimens which were immersed in alkaline solution at 60°C failed in several hours, whereas the samples tested in a 20°C alkaline environment exhibited behavior similar to that of samples tested in air ⁵⁹. Aslanova and Resnyansky found zirconium-based glass and aramid reinforcements to possess the best chemical resistance in 0.5 N NaOH and 0.5 NH₂SO₄. ⁶⁰.

Prestress losses in glass reinforced composite were investigated by Issa and Amer ⁶¹. Concrete cylinders were prestressed with both steel and FRP tendons to the same stress level. After the concrete had fully cured, the tendons were cut and an axial load was applied. Prestress forces, applied loads and sustained loads were monitored as a function of time. It was observed that prestress losses in the FRP tendons were

considerably lower than in the steel tendons, and that the permanent effective prestress in FRP tendons is higher than in steel. The data obtained in this study was used to verify models which were developed for predicting strain history, prestress losses and effective prestress of FRP tendon-reinforced concrete.

Exposure to saline environments encountered in coastal areas and marine environments has a significant impact on FRP rebar durability. Sen et al. compared the durability of steel and glass/epoxy pretensioned concrete beams immersed in a salt water tidal chamber. Specimens were cycled between wet and dry conditions and exhibited degradation which increased as a function of number of cycles. As shown in Figure 7, both uncracked and precracked beams reinforced with FRP rebar failed much more quickly than the control, unexposed beams when exposed to seawater. It was postulated that moisture combined with the alkali ions in concrete and formed hydroxyl ions which attacked the silicon-oxygen-silicon network of the glass fiber.⁶² No visual signs of deterioration on the FRP-reinforced beams were observed, unlike steel-reinforced beams which undergo spalling and provide warning of imminent failure. Arockiasamy et al. carried out durability studies of carbon FRP imbedded in concrete beams and pretensioned to 60% of ultimate strength. Even after 9 months immersion in sea water, flexural strengths of the beams were not reduced, but failure modes changed from compressive to debonding⁶³.

Rehabilitation and Retrofitting of Existing Structures

Post-strengthening of a structure becomes necessary when its safety and/or serviceability become compromised and can no longer be guaranteed. Steel has been utilized since 1967 to rehabilitate structures, but is heavy, difficult to handle and prone to corrosion. The characteristics of FRP which were discussed at length earlier in this review make it an ideal candidate for structural reinforcement. Materials which have been post-strengthened with FRP include concrete, steel and timber.

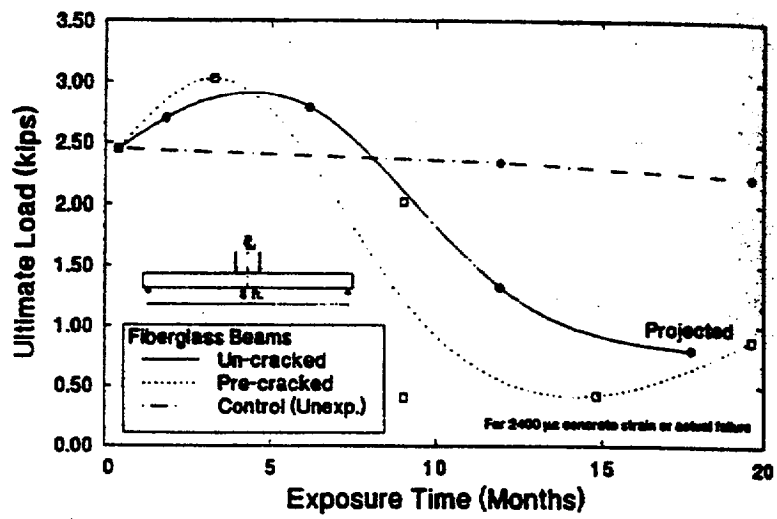

Figure 7: Changes in ultimate capacity as a function of exposure for uncracked and precracked FRP rebar reinforced concrete exposed to sea water, compared with the unexposed controls [62].

Concrete--An example of a concrete structure which has been rehabilitated with composite plates include the 228 m Ibach Bridge, near Lucerne, Switzerland. It was reinforced with three carbon fiber-reinforced composite sheets, which had a total weight of 6.5 kg. This quantity is in contrast with 175 kg of steel which would have been necessary to accomplish the same job (a net reduction in weight of approximately 96%). Another rehabilitation project involved the main terminal of the Swiss Railway System in Zurich, in which the ground floor concrete slab had to be reinforced with FRP in order withstand to the loads imposed by new construction ⁶⁴. A thorough review of the important design issues involved in reinforcing concrete with FRP can be found in the report by Swamy and Mukhopadhyaya ⁶⁵.

The success of externally reinforcing concrete structures with FRP is dependent on the bonding adhesive used to bond the FRP to the concrete, which is usually an epoxy-based material. Surface preparation of the concrete and FRP surface is also critical to long-term bond integrity. In the majority of the studies included here, roughening of the concrete surface was accomplished by blasting or brushing; composite surfaces were also lightly blasted and/or cleaned with solvent prior to bonding. In some cases, primer was also applied to one or both substrates ⁶⁶.

Chajes et al. used a single lap shear configuration to study the bond strength and force transfer between glass-reinforced composite and concrete ⁶⁷. Concrete surfaces were prepared by grinding with a stone wheel, which provided a smooth finish, or grinding with a wire brush, which yielded a rougher topography. Composite surfaces were treated by blasting with glass beads, followed by an acetone wipe. Both epoxy and urethane adhesives were utilized. The majority of the failures occurred within the concrete substrate. The highest average shear stress at failure corresponded with the use of an epoxy adhesive in conjunction with the mechanically roughened surface.

Karbhari and Engineer utilized a modified peel test to determine peel strengths and interfacial fracture energies for composite/concrete bonds ⁶⁸. Glass-reinforced epoxy sheet was peeled away from the concrete substrate and the peel force was used to calculate the interfacial fracture energy G and its components, G_{IC} and G_{IIC} , the contributions from opening and sliding modes, respectively. Exposure of the specimens to

fresh and sea water did not significantly affect G_{IC} , but caused a significant decrease in G_{IIC} . Examination of the peel surfaces revealed a change from mode I fracture to a mixed-mode condition with fracture proceeding along the interface. Increases in both G_{IC} and G_{IIC} were observed following sub-ambient exposure and freeze/thaw cycling; this is attributed to an increase in specimen stiffness which in turn increases the bending stresses. Both G_{IC} and G_{IIC} data for the bonded concrete/composite specimens are shown in Figure 8.

Both glass and carbon fiber composites were bonded with either epoxy and acrylic adhesives to the tension face of a concrete beam by Varastehpour and Hamelin^{45,69}. Samples tested in 4-point bending showed significant increases in both flexural and shear strength. Lap shear specimens tested in compression showed significant differences in load deflection behavior from one adhesive to another; rubber-toughened epoxy adhesives were found to be superior in allowing full FRP action to be achieved.

Increases in ultimate loads and stiffness were also observed by Quantrill et al. in bonding unidirectionally reinforced glass fiber composite to concrete beams, relative to beams with no external composite reinforcement. A model was developed to simulate beam performance incorporating properties of concrete, steel, composite and adhesive; predicted beam response corresponded well with experimental data⁷⁰.

Muszynski and Sierakowski studied the durability of carbon fiber-reinforced composite bonded to concrete with an epoxy adhesive. Surfaces were abraded and primed prior to applying the adhesive. Bonded beams were exposed to UV, freeze/thaw and hot/wet cycling. UV-exposed specimens exhibited the largest decreases in flexural strength and toughness⁷¹.

Carbon fiber-reinforced laminates bonded to concrete with an epoxy adhesive were tested in 3-point bending in room temperature water, as well as in freeze/thaw conditions, for 2 months. The load bearing capacity of the composite-reinforced beams increased almost 4-fold compared to non-reinforced beams, with longer and thinner reinforcing sheets providing the greatest improvement. Figure 9 illustrates the improvement in beam properties following repair with FRP sheets. No significant changes in load-bearing capacity were observed following the 2 month water immersion, whereas a slight decrease

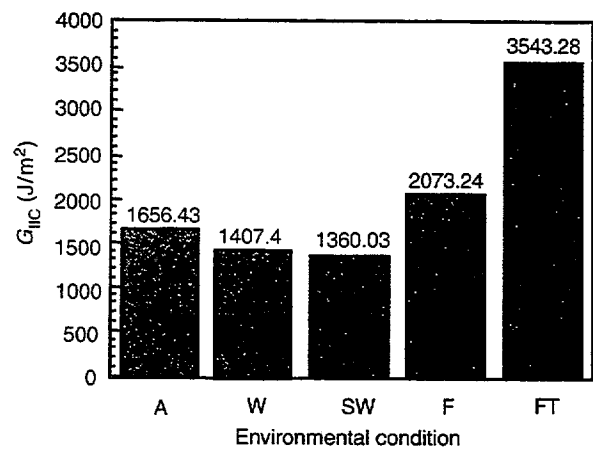
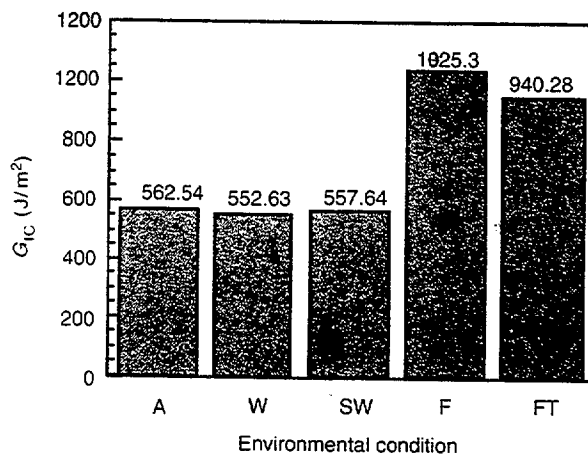

Figure 8: G_{IC} and G_{IIC} values obtained from peel testing for concrete/composite bonds exposed to air, water, seawater, freezing and freeze/thaw conditions [68].

Results of three-point bending of repaired samples.

Sample	Original Properties		After Repair with Composites		
	Load Bearing Capacity (kN)	Deflection (mm)	Load Bearing Capacity (kN)	Percent Restoration	Deflection (mm)
C7	4.9	0.3	13.0	325	1.22
C8	4.5	0.3	14.5 ¹	322	1.31
C9	4.8	0.37	15.4 ¹	321	1.11
RC31	12.5 ²	0.96	8.3	66.4	1.25
RC32	14.5 ²	1.00	10.5	72.4	1.37
RC33	13.4 ²	0.93	11.8 ¹	88.1	1.42
RC34	13.4 ²	0.77	10.8 ¹	80.6	0.96
RC37	12.6 ³	0.90	15.6	116 ⁴	1.34
RC38	13.3 ³	0.82	20.4	151 ⁴	1.13

¹Two months in water after repair.

²Completely damaged.

³Did not fail completely.

⁴Using the average ultimate load of RC (13.5 KN) as reference.

Figure 9: Comparison of damaged concrete beam properties with properties of beams repaired with composite plates [72].

in strength occurred after freeze/thaw cycling. The viscosity of the applied adhesive also had an impact on beam strength, with the lower-viscosity materials providing the greatest improvement in strength ⁷².

The strengthening of a concrete structure with external composite reinforcement can be further enhanced if the composite sheets are prestressed prior to bonding to the concrete. This involves pretensioning the FRP, bonding the sheets to the concrete and releasing the load after the adhesive has cured, as shown in Figure 10. Triantafillou et al. bonded 0.75 mm thick carbon fiber-reinforced epoxy plates with an epoxy adhesive which was filled with quartz powder and sand to improve creep behavior and reduce cost. The main obstacle was to determine how to clamp the FRP ends during the prestressing operation. In this work, two pairs of gradually tapered steel plates were used to minimize stress concentrations. Prestress levels ranged from 190 to 280 MPa. All concrete beams with prestressed reinforcement exhibited superior strength to the non-prestressed beams, this is illustrated in Figure 11 ⁷³.

An alternative to composite plates are fabrics which are directly bonded to the structure with an adhesive. The advantages of using fabrics to reinforce a structure are that they can be applied to nonflat surfaces and are also less expensive than the prefabricated FRP plates. Fabrics utilized in a study by Chajes et al. included plain weave Kevlar, crowfoot satin weave E-glass and plain weave graphite. The concrete surfaces were abraded and coated with adhesive. The fabric was cut to the desired lengths, impregnated with adhesive on both sides and applied to the concrete. Curing was then carried out under vacuum. Beams reinforced in this manner displayed increases in flexural capacity of at least 45% over control beams ⁷⁴. Figure 12 shows a comparison of concrete beams internally reinforced with steel and externally reinforced with FRP and beams with steel internal reinforcement only. A follow-up study addressed the effect of freeze/thaw and wet/dry cycling and immersion in calcium chloride solutions. Both conditions degraded the composite/concrete bond, which in turn led to decreases in beam strength. The beams which were reinforced with graphite fabric exhibited the least degradation ⁷⁵.

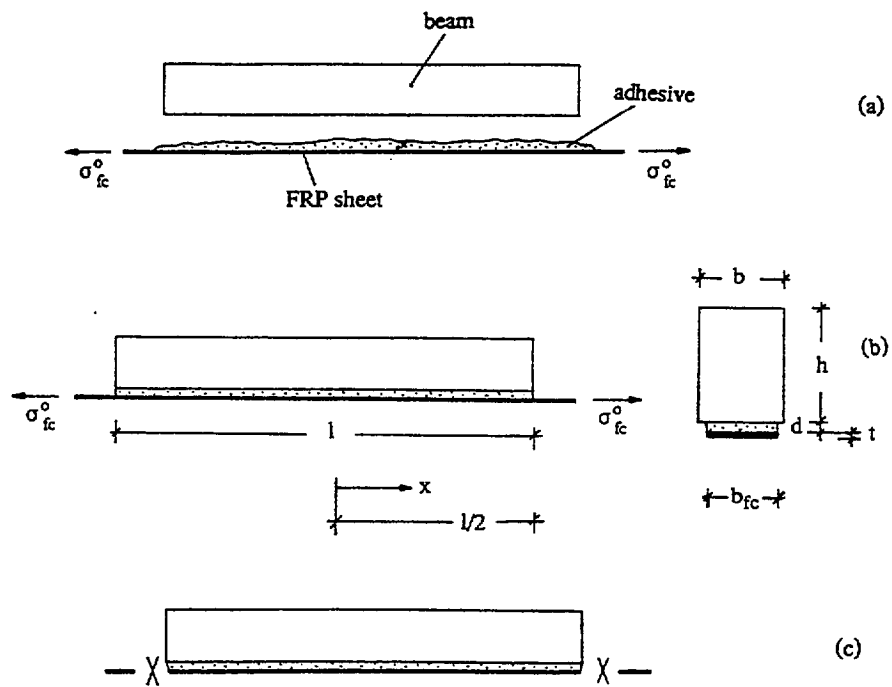

Figure 10: Method of concrete reinforcement with pretensioned FRP sheets: (a) Prestressing of FRP sheet, (b) Curing of adhesive, and (c) Release of FRP ends [73].

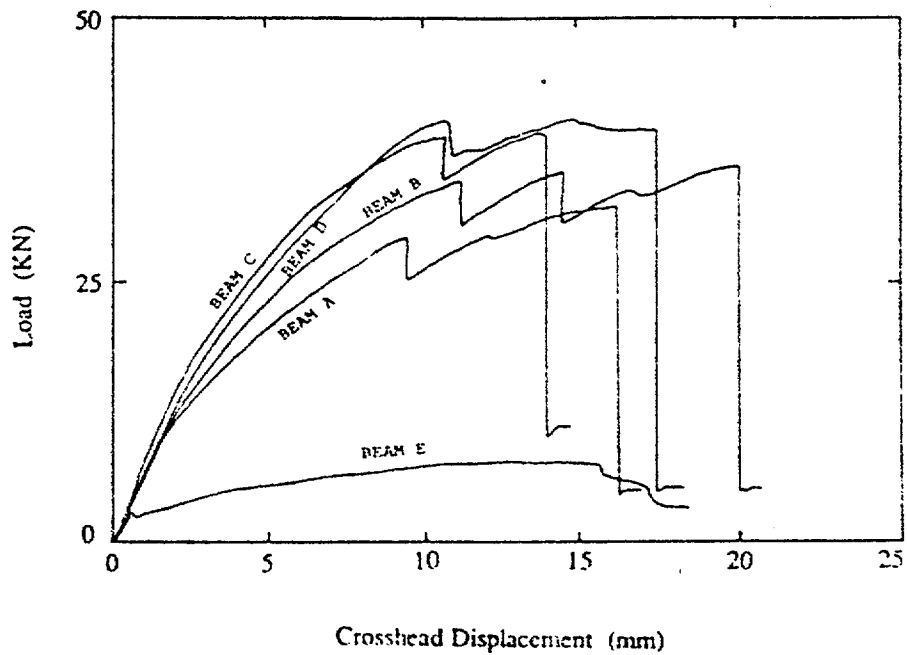

Figure 11: Load/displacement curves for concrete beams externally reinforced with prestressed carbon FRP, (Beams A through D), compared to the control beam (E) with no FRP reinforcement. [73].

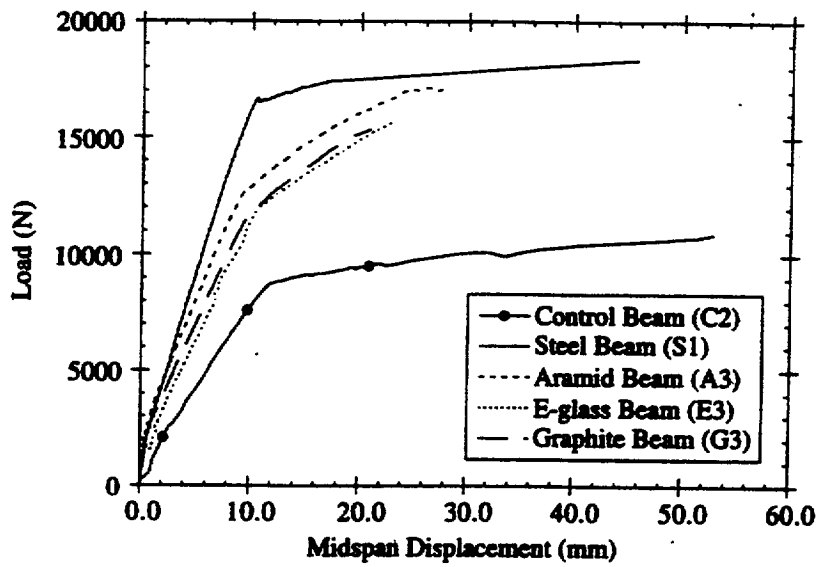

Figure 12: Plot of load versus midspan deflection for various beams: All beams are reinforced with standard steel rebar, except for S1, which is reinforced with twice the steel reinforcement of the others. Beams A3, E3 and G3 are reinforced with aramid, glass and graphite fabrics respectively [74].

Steel--It is estimated that over 58% of the 108,000 structurally deficient bridges in the United States are constructed of steel ⁷⁶. Steel corrosion has increased over the last few decades due to more widespread use of de-icing salts, compounded by heavy traffic volumes which often exceed original design loads. FRP patches are used to transfer loads across deteriorated sections and restore structural integrity. This repair scheme is an attractive alternative to complete bridge or deck replacement.

Because most FRP materials are only 60% as stiff as steel ⁷⁷, the thickness of the laminates needed to reinforce a steel structure is critical. Sen et al. evaluated carbon fiber laminates for reinforcing steel bridge sections, ranging in thickness from 0.05 mm to 5 mm ⁷⁷. Epoxy adhesives and mechanical fasteners were used to fasten the FRP to the underside of the bridge deck. Finite element analysis results predicted high peeling stresses at the plate edges, necessitating the use of clamps. Increases in the strengths of reinforced bridge sections ranged from 11-50%, depending on the reinforcing laminate thickness. Stiffness of the steel sections increased 20-32% for the 2 mm laminate and 29-67% for the 5 mm laminate. It was recommended that long term durability studies be carried out to ensure that carbon fiber/steel contact does not initiate galvanic corrosion.

Karbhari and Shulley utilized the wedge test (ASTM D 3762-79), with steel as one adherend and epoxy FRP as the other, to study bond durability between FRP and steel in various environments ^{76,78}. Steel surfaces were prepared by grit blasting, primer or silane coating. Samples were exposed to ambient, saline, hot/wet, ambient/wet, freeze/thaw and sub-ambient conditions. The most severe deterioration, as quantified by crack lengths, was observed in the hot/wet environment, while the sub-ambient exposure had the least effect. This data is summarized in Figure 13. Beam tests were also conducted in which a 10.2 cm (4 in). hole was drilled into the web of a steel beam and a FRP reinforcement patch was applied. The patched beams were tested in 3-point bending. Test results revealed that patched beams withstood higher loads than the unpatched, but the original (undamaged) beam stiffness was not completely restored.

Timber--FRP/wood hybrid structures not only provide improved strength and stiffness, but allow the utilization of lower grade lumber in construction. The question of whether

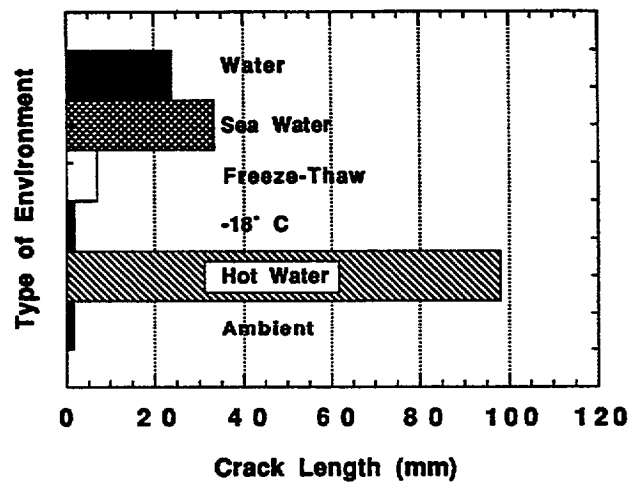

Figure 13: Crack lengths for steel/composite wedge specimens after 7 days in various environments [78].

FRP could be successfully bonded to wood beams was addressed by Chajes et al.⁷⁹. An experimental program was undertaken in which different combinations of engineered wood, carbon fiber-reinforced composite and concrete were tested in 4-point bending. The components were joined using a combination of resorcinol-phenol-formaldehyde adhesives and mechanical fasteners. Surface preparation consisted of an acetone wipe of both the FRP and wood surfaces. Results showed that good adhesion between the FRP and wood could be achieved, and the tensile strain capacity of the beam was increased as well.

The bond strength between yellow poplar and glass-reinforced vinyl ester was investigated by Barbero et al.⁸⁰. Interfacial testing of wood/composite bonds was carried out under both wet and dry conditions utilizing the test method described in ASTM D905. Shear strengths were measured and compared to finite element analysis predictions. The finite element results and measured shear values compared quite favorably.

Triantafillou and Deskovic bonded a unidirectionally carbon fiber-reinforced epoxy laminate to the tension side of beechwood beams with epoxy adhesive⁸¹. The carbon fiber laminate were pretensioned prior to adhering it to the beam. It was shown that pretensioning significantly increased the ultimate bending capacity, strength, stiffness and ductility of the wood member. FRP reinforced beams that were not prestressed also exhibited higher strength, stiffness and ductility, but not to the degree exhibited by the prestressed specimens.

Column Wrapping--In a seismic event, concrete columns with inadequate steel reinforcement directly contribute to the catastrophic collapse of bridges. A column's seismic load-bearing capacity can be increased by externally wrapping the column with fiber-reinforced composite wraps or tapes. The wraps can be applied to the column without additional confining pressure (passive) or with additional tensile strain so that active pressure is imposed on the column. Composite-wrapped columns possess increased ductility, shear resistance and lateral displacement hysteresis^{82,83}.

Three types of column wraps were utilized by Nanni and Bradford: aramid fiber-reinforced epoxy, glass-reinforced isophthalic polyester and vinyl ester, and preformed

glass and aramid-reinforced preformed shells. The concrete columns were tested in uniaxial compression. Columns which were confined with FRP wraps exhibited enhanced strength and ductility ⁸⁴.

Masonry--In a building structure, load-bearing masonry walls are susceptible to earthquake damage due to their poor lateral load stability. Many masonry structures in seismically active zones do not meet current design load requirements and require post-strengthening. Strengthening of masonry structures by the bonding of glass-reinforced epoxy to wall surfaces is currently under study ⁸³.

Schwegler analyzed two methods of reinforcing walls with FRP. In the first, pultruded carbon fiber laminates were bonded to walls in a diagonal configuration and anchored to ceiling and floor slabs. Another method involved bonding a woven polyester fabric to the entire surface of the wall with epoxy. The effect of this procedure is to increase the ductility of the wall, which in turn initiates more uniform crack formation. Large scale testing showed that walls could be strengthened with the FRP materials, improving earthquake resistance up to a factor of 4.3 ⁸⁵.

Joining/Fastening of Composite Components

Like any other structural materials, fiber-reinforced composites must often be joined to create useful structures. For full structural efficiency the ideal composite structure would be manufactured as one monolithic entity. However, limitations in manufacturing technology, as well as transportable size and weight, lead to the need for connections in composite structures ^{86,87}. Very little attention has been given to the joining of composite components for constructed facilities. This is an important area of research, however, because improper joint design or joining techniques can counteract any weight or strength advantages gained by the use of composite materials. For the thermosetting matrix resins which will be predominantly used in the semi-structural and structural markets, the three main methods for joining are mechanical fastening, adhesive bonding and the combination of mechanical fastening/adhesive bonding ^{88,89}. Mechanical

fastening is not discussed in this report, since an excellent review is provided by Mosallam ⁸⁹.

Adhesively-bonded structures can carry greater loads than those which are mechanically fastened, because loading is distributed over a larger area, resulting in lower stresses. It has also been shown that adhesively-bonded assemblies have fatigue lives up to 20 times longer than riveted structures fabricated with identical components ⁹⁰. Mechanical fastening, which involves the use of bolts, screws and rivets, can often be detrimental to structural durability. FRP materials cannot readily yield to reduce the stress concentrations in the composite induced by the higher modulus fastener. Instead, the composite may undergo fiber/matrix debonding or intraply/interply splitting to alleviate the localized stresses ^{90,91,92}. In addition, cutting and drilling of an FRP component, which is necessary to accommodate a mechanical fastener, may lead to additional damage and increased susceptibility to interlaminar shear failure in the composite ⁸⁷.

However, bonding or fastening of FRP materials presents a special challenge, due to the nature of the matrix resin. Polymeric materials, both thermoplastic and thermosetting, have lower surface energies than their metallic or ceramic counterparts. This is due to the chemical make-up of a polymeric surface as well as to residues of mold release, usually fluorine or silicon-based, which are often left behind following composite fabrication. Numerous studies have shown that if fluorine and silicon-based release agents on bonding surfaces are not removed, joints with low strength and decreased durability can result ^{93,94,95}.

Abrasion is a method commonly used to remove surface contaminants, as well as to create a roughened surface for increased bonding area ⁹⁶. Another method involves the use of a peel ply, a woven fabric co-cured on the surfaces of the composite laminate and removed just prior to bonding. The peel ply surface layer prevents the deposition of release agent residues and also provides a texturized surface having increased bonding area ^{97,98}. Other less commonly used composite surface preparation techniques are gas plasma ^{93,94,99}, corona discharges ^{100,101}, lasers ¹⁰² and chemical oxidizing agents ⁹⁷. A number of these surface treatments are compared in bonding studies on epoxy composites ^{103,104}.

Melhem and Schlup studied static strength, creep strength, fracture toughness and durability of composite joints subjected to cyclic loads and environmental exposure. The surface preparation technique utilized was peel ply alone and peel ply coupled with sandpaper abrasion. It was found that all of the surface preparation and environmental exposure variables in the study were overshadowed by whether the joints were tested in a single-lap or double-lap configuration ¹⁰⁵.

The bonding of two glass/isophthalic polyester I-beams between flat outer sheet plates was carried out by Mottram with a toughened epoxy adhesive. The two I-beams had a residual surface layer of release agent as well as a polyester surface veil, both of which were removed by shot blasting prior to bonding. The bonded dual beam assembly was tested in 3-point creep loading, where a reduction of approximately 7% in stiffness was found due to the presence of the adhesive. No deterioration in the bond was found after 87,600 hours (10 years), and recovery occurred a few short hours after load removal. The change in initial deflection over the loading period showed a good fit to the creep model developed by Findlay, demonstrating linear viscoelastic properties ¹⁰⁶.

Graphite/epoxy bridge girders bonded to concrete slabs with an epoxy adhesive were studied in 4-point bending by Gordaninejad et al. Good agreement was found between theoretical simulation and experimental studies. At a certain load, slip at the composite/concrete interface was observed to occur, causing a decrease in the stiffness of the structure. This event, however, did not affect the ultimate failure load and the theoretical models were still valid for predicting failure loads ¹⁰⁷.

For FRP used in an marine environment, the decision to be made between mechanical fastening or adhesive bonding becomes even more critical, particularly for carbon or graphite-reinforced laminates. Mechanical fasteners will be in direct contact with the exposed ends of reinforcing fibers in a hole or machined edge. The high electrical conductivity of graphite or carbon can serve to initiate galvanic corrosion in the presence of an actively corroding metal and an electrolyte (such as sea water). As the metal corrodes, electron flow from the fibers causes oxygen to become reduced at the fiber surface to form hydroxyl ions. These ions can initiate hydrolysis reactions in the polymer phase ¹⁰⁸. Researchers have confirmed degradation of imide-containing matrices, such as

bismaleimide, in contact with aluminum and salt water^{109,110}. Reactions with epoxy resins are slow, but resins such as polyesters or cyanates containing hydrolyzable groups may be susceptible¹⁰⁸.

Conclusions

Current research in the use of fiber-reinforced composites in construction has been reviewed. FRP materials have been studied in a number of infrastructure applications and have been called upon for reinforcement, rehabilitation and incorporation into structural components. A number of technical concerns and design issues which need to be resolved before composites are widely accepted into the infrastructure arena. Of primary concern is the long term durability of these materials under natural weathering and/or corrosive environments coupled with mechanical stresses. Future work should address fundamental mechanisms which govern the degradation of resin matrices, reinforcing fibers and the interface between the two. The interactions of composite materials with traditional supporting materials such as steel, timber and concrete should also be investigated more extensively. A working knowledge of how material properties change as a function of climate, time and loading will also be of great value to the engineering and design communities. This is a field in which tremendous opportunities exist for acquiring a base of knowledge on material durability and service life, and research efforts which are ongoing in this area will undoubtedly make a significant impact on the future of the construction industry.

References

- ¹ K.F. Dunker and B.G. Rabbat, "Why America's Bridges are Crumbling", *Scientific American*, p. 66, March 1993.
- ² *Composite News: Infrastructure*, 34, Oct. 31, 1995.
- ³ Civil Engineering Research Foundation, "High Performance Construction Materials and Systems: An Essential Program for America and Its Infrastructure", Executive Report 93-5011, 1993.
- ⁴ C.A. Ballinger, "Development of Composites for Civil Engineering", *Advanced Composite Materials in Civil Engineering Structures, Proceedings of the Specialty Conference*, S.L. Iyer and R. Sen, eds., p. 288, ASCE, 1991.
- ⁵ C.A. Randazzo, "Composites Break Another Record in 1994", *50th Annual Conference, Composites Institute*, p. 9-A/1, 1995.
- ⁶ L.C. Hollaway, *Polymers and Polymer Composites in Construction*, Thomas Telford Ltd., 1990, p. 78.
- ⁷ V. Rao and L.T. Drzal, "The Temperature Dependence of Interfacial Shear Strength for Various Polymeric Matrices Reinforced with Carbon Fibers", *J. Adhesion*, 37, 83 (1992).
- ⁸ *Structural Plastics Selection Manual*, ASCE Manuals and Reports on Engineering Practice No. 66, ASCE, 1985.
- ⁹ *ASM Engineered Materials Handbook*, vol. 1, Composites, pp. 35-37 (ASM International, 1993).
- ¹⁰ R.W. Hertzberg and J.A. Manson, *Fatigue of Engineering Plastics*, Academic Press, 1980.
- ¹¹ J.J. Aklonis and W.J. MacKnight, *Introduction to Polymer Viscoelasticity*, 2nd edition, Wiley-Interscience, 1983.
- ¹² J.D. Ferry, *Viscoelastic Properties of Polymers*, 3rd edition, Wiley-Interscience, 1980.
- ¹³ *ASM Engineered Materials Handbook*, vol. 1, Composites, pp. 45-48 (ASM International, 1993).
- ¹⁴ A. Davis and D. Sims, *Weathering of Polymers*, Applied Science Publishers, 1983.
- ¹⁵ J.G. Williams, "Opportunities for Composites in the Offshore Oil Industry" *National Conference on the Use of Composite Materials in Load-bearing Marine Structures. Vol. II: Conference Proceedings*, p.91, National Academy Press, 1990
- ¹⁶ A. Letton and W.L. Bradley, "Studies in Long Term Durability of Composites in Seawater", *National Conference on the Use of Composite Materials in Load-bearing Marine Structures. Vol. II: Conference Proceedings*, p. 163, National Academy Press, 1990.

-
- ¹⁷ J. Gerald, "Place of Composite Materials in Marine Structures", *Welding in the World*, **32**, 83 (1993).
- ¹⁸ F.E. Sloan and J.B. Talbot, "Corrosion of Graphite Fiber-Reinforced Composites II-Anodic Polarization Damage", *Corrosion*, **48**(12), 1020 (1992)
- ¹⁹ G.S. Springer, "Environmental Effects on Composite Materials", *National Conference on the Use of Composite Materials in Load-bearing Marine Structures*. Vol. II: Conference Proceedings, p.91, National Academy Press, 1990.
- ²⁰ W.C. Tucker and R. Brown, "Moisture Absorption of Graphite/Polymer Composites Under 2000 Feet of Seawater", *Journal of Composite Materials*, **23**, 787 (1989).
- ²¹ R. Kosuri and Y. Weitsman, "Sorption Process and Immersed-Fatigue Response of GR/EP Composites in Seawater", *Proc. 10th International Conference on Composite Materials (ICCM-10)*, vol. VI, p. 177.
- ²² S.K. Rege and S.C. Lakkad, "Effect of Salt Water on Mechanical Properties of Fibre-Reinforced Plastics", *Fiber Science and Technology*, **19**, 317 (1983).
- ²³ R.D. Adams and M.M. Singh, "The Effect of Immersion in Sea Water on the Dynamic Properties of Fibre-reinforced Flexibilixed Epoxy Composites", *Composite Structures*, **31**, 119 (1995).
- ²⁴ C.R. Crowe and D.F. Hasson, "Materials Trends in Marine Construction", Report #EW-1-90, January 1990.
- ²⁵ E. Morsi and J. Larralde, "Design and Construction of Fiberglass Composite Building", *Infrastructure: New Materials and Methods of Repair, Proceedings of the Third Materials Engineering Conference*, San Diego, Nov. 13-16, 1994 (ASCE), p. 751.
- ²⁶ S.L. Iyer, V. Ranganathan and T. Gross, "Fiber-Glass Composite Aircraft Pad for Crop Dusting", *Infrastructure: New Materials and Methods of Repair, Proceedings of the Third Materials Engineering Conference*, San Diego, Nov. 13-16, 1994 (ASCE), p. 743.
- ²⁷ B.N. Robson, M.W. Whitney, I. E. Harik, T. Hopwood II, "Design of Longest RP Suspension Bridge in the World", 50th Annual Conference, Composites Institute, 1995.
- ²⁸ A. Green, T. Bisarnsin and E. A. Love, "Pultruded Reinforced Plastics for Civil Engineering Structural Applications", *J. Reinforced Plastics and Composites*, **13**, 942 (1994)
- ²⁹ M. A. Khalifa and M.K. Tadros, "The World's Longest Cable-stayed Foot-Bridge Using Fiber Reinforced Plastics", *Infrastructure: New Materials and Methods of Repair, Proceedings of the Third Materials Engineering Conference*, p. 207, 1994 (ASCE).
- ³⁰ E. Barbero and H.V.S. GangaRao, "Structural Applications of Composites in Infrastructure, Part I, *SAMPE Journal*, **27**(6), 9 (1991).

-
- ³¹ E. Barbero and H.V.S. GangaRao, "Structural Applications of Composites in Infrastructure, Part II, *SAMPE Journal*, 28(1), 9 (1992).
- ³² A. S. Mosallam and L.C. Bank, "Creep and Recovery of a Pultruded FRP Frame", *Advanced Composite Materials in Civil Engineering Structures, Proceedings of the Specialty Conference*, S.L. Iyer and R. Sen, eds. (ASCE 1991).
- ³³ M. Holmes and T.A. Rahman, "Creep Behavior of Glass-Reinforced Plastic Box Beams", *Composites*, p 79, April 1980.
- ³⁴ D.W. Scott, J.S. Lai and A.-H. Zureick, "Creep Behavior of Fiber-Reinforced Polymeric Composites: A Review of the Technical Literature", *J. Reinforced Plastics and Composites*, 14, 588 (1995).
- ³⁵ D.J. Herzog, P.P. Burrell and T. B. Brown, "Durability and Projected Service Life of Reinforced Plastic Composites", 50th Annual Conference, Composites Institute, 1995.
- ³⁶ J.T. Mottram, "Compression Strength of Pultruded Flat Sheet Material", *Journal of Materials in Civil Engineering*, 6(2), 185 (1994).
- ³⁷ K. Berg and J.F. Mayfield, "Acoustic Emission Testing of Fiberglass Molded Grating", *Infrastructure: New Materials and Methods of Repair, Proceedings of the Third Materials Engineering Conference, San Diego*, p. 131, 1994 (ASCE).
- ³⁸ A. Chiu and R.J. Franco, "FRP Linepipe for Oil and Gas Production", *Coatings and Linings*, p. 21, June 1990.
- ³⁹ C. Robbe, "A New Look at the Use of Glass-Fiber Reinforced Plastic Piping", *Coatings and Linings*, p. 29, June 1990.
- ⁴⁰ M.A. Erki, P. Yantha, M.F. Green, G.E. Johansen, R. Wilson and D. Maurer, "Experimental Behavior of a Reinforced Plastic Vehicle Bridge", 50th Annual Conference, Composites Institute, 1995.
- ⁴¹ F.C. McCormick, "Final Report: Fatigue Study of a GRP Pedestrian Bridge", Technical Report, Transportation Research Board, 1987.
- ⁴² U. Meier, "Carbon Fiber-Reinforced Polymers: Modern Materials in Bridge Engineering", *Structural Engineering International*, January 1992, p. 7.
- ⁴³ R. D. Roll, "Use of GFRP Rebar in Concrete Structures", p. 93, *Advanced Composite Materials in Concrete Structures, Proceedings of the Specialty Conference*, S.L. Iyer and R. Sen, eds., ASCE, 1991).
- ⁴⁴ E. Barbero and H.V.S. GangaRao, "Structural Applications of Composites in Infrastructure, Part II, *SAMPE Journal*, 28(1), 9 (1992).

-
- ⁴⁵ H. Saadatmanesh, "Fiber Composites for New and Existing Structures", *ACI Structural Journal*, 91(3), 346 (1994).
- ⁴⁶ C.J. Burgoyne, "Should FRP be Bonded to Concrete?", *Fiber-reinforced Plastic Reinforcement for Concrete Structures International Symposium*, p. 367, A. Nanni and C.W. Dolan, eds., ACI, 1993).
- ⁴⁷ T. Uomoto, T. Nishimura and H. Ohga, "Static and Fatigue Strength of FRP Rods for Concrete Reinforcement", *Non-Metallic (FRP) Reinforcement for Concrete Structures*, p. 100, L. Taerwe, ed., RILEM, 1995.
- ⁴⁸ M. Scheibe and R.S. Rostasy, "Aspects of Laboratory Testing to Determine Mechanical Properties of FRP", p. 116, *Non-metallic (FRP) Reinforcement for Concrete Structures*, L. Taerwe, ed., RILEM, 1995.
- ⁴⁹ A. Nanni, C.E. Bakis and T.E. Boothby, "Test Methods for FRP-Concrete Systems Subjected to Mechanical Loads: State of the Art Review", *J. of Reinforced Plastics and Composites*, 14, 524 (1995).
- ⁵⁰ H.C. Boyle and V.M. Karbhari, "Bond and Behavior of Composite Reinforcing Bars in Concrete", *Polym-Plast. Technol. Eng.*, 34(5), 697 (1995).
- ⁵¹ M. Mashima and K. Iwamoto, "Bond Characteristics of FRP Rod and Concrete after Freezing and Thawing Deterioration", *Fiber-reinforced Plastic Reinforcement for Concrete Structures International Symposium*, p. 51, A. Nanni and C.W. Dolan, eds., ACI, 1993.
- ⁵² A. Nanni, M.M. Al-Zaharani, S.U. Al-Dulaijan, C.E. Bakis and T.E. Boothby, "Bond of FRP Reinforcement to Concrete - Experimental Results", p. 135, *Non-metallic (FRP) Reinforcement for Concrete Structures*, L. Taerwe, ed., RILEM, 1995.
- ⁵³ M.A. Issa, R. Sen, A. Amer, "Comparative Study of Transfer Length in Fiberglass and Steel Pretensioned Concrete Members", *PCI Journal*, Nov/Dec. 1993, p. 53.
- ⁵⁴ V.A. Rossetti, D. Galeota, M.M. Giammatteo, "Local Bond Stress-Slip Relationships of Glass Fibre-Reinforced Plastics Bars Embedded in Concrete", *Materials and Structures*, 28, 340 (1995).
- ⁵⁵ R. Sen, M. Issa, A. Sun and M. Shahawy, "Static Response of Fiberglass Pretensioned Beams", *J. Structural Engineering*, 120(1), 252 (1994).
- ⁵⁶ M. Scheibe and R.S. Rostasy, "Engineering Model of Stress-Rupture of AFRP in Concrete", p.74, *Non-metallic (FRP) Reinforcement for Concrete Structures*, L. Taerwe, ed., RILEM, 1995.
- ⁵⁷ A. Gerritse and J.A. Den Uijl, "Long Term Behavior of Arapree", *Non-metallic (FRP) Reinforcement for Concrete Structures*, L. Taerwe, ed., RILEM, 1995.
- ⁵⁸ F. Katsuki and T. Uomoto, "Prediction of Deterioration of FRP Rods Due to Alkali Attack", p.82, *Non-metallic (FRP) Reinforcement for Concrete Structures*, L. Taerwe, ed., RILEM, 1995.

-
- ⁵⁹ M. Scheibe and R.S. Rostasy, "Stress Rupture of AFRP subjected to Alkaline Solutions and Elevated Temperature Experiments", *Non-metallic (FRP) Reinforcement for Concrete Structures*, L. Taerwe, ed., RILEM, 1995).
- ⁶⁰ L.G. Aslanova and O.A. Resnyansky, "The Principle Operational Properties of New Types of Non-Metallic Reinforcement for Structures", *Non-metallic (FRP) Reinforcement for Concrete Structures*, L. Taerwe, ed., RILEM, 1995.
- ⁶¹ M.A. Issa and A. Amer, "Prestress Losses in Fibreglass Pretensioned Concrete Compression Members", *Materials and Structures*, 28, 330 (1995).
- ⁶² R. Sen, D. Mariscal and M. Shahawy, "Durability of Fiberglass Pretensioned Beams", 90(5), *ACI Structural Journal*, 525 (1993).
- ⁶³ M. Arockiasamy, M. Zhuang and K. Sandepudi, "Durability Studies on Prestressed Concrete Beams with CFRP Tendons", p. 456, *Non-metallic (FRP) Reinforcement for Concrete Structures*, L. Taerwe, ed., RILEM, 1995.
- ⁶⁴ U. Meier and A. Winistorfer, "Retrofitting of Structures Through External Bonding of CFRP Sheets", p. 467, *Non-metallic (FRP) Reinforcement for Concrete Structures*, L. Taerwe, ed., RILEM, 1995.
- ⁶⁵ R.N. Swamy and P. Mukhopadhyaya, "Role and Effectiveness of Non-Metallic Plates in Strengthening and Upgrading Concrete Structures", p. 473, *Non-metallic (FRP) Reinforcement for Concrete Structures*, L. Taerwe, ed., RILEM, 1995.
- ⁶⁶ M. Arduini, A. D'Ambrisi and A. Di Tommaso, "Shear Failure of Concrete Beams Reinforced With FRP Plates", *Infrastructure: New Materials and Methods of Repair, Proceedings of the Third Materials Engineering Conference, San Diego, Nov. 13-16, 1994 (ASCE)*, p.123.
- ⁶⁷ M.J. Chajes, W.W. Finch, Jr., T.F. Januszka, T.A. Thomson, Jr., "Bond and Force Transfer of Composite-Material Plates Bonded to Concrete", *ACI Structural Journal*, 93(2), 208 (1996).
- ⁶⁸ V.M. Karbhari and M. Engineer, "Assessment of Interfacial Energy between Concrete and Glass Reinforced Composites", *J. Mater. Sci. Letters*, 14, 1210 (1995).
- ⁶⁹ V. Varastehpour and P. Hamelin, "Structural Behavior of Reinforced Concrete Beams Strengthened by Epoxy Bonded FRP Plates", p. 559, *Non-metallic (FRP) Reinforcement for Concrete Structures*, L. Taerwe, ed., RILEM, 1995.
- ⁷⁰ R.J. Quantrill, L.C. Hollaway, A.M. Thorne and G.A.R. Parke, "Preliminary Research on the Strengthening of Reinforced Concrete Beams Using GFRP", p. 541, *Infrastructure: New Materials and Methods of Repair, Proceedings of the Third Materials Engineering Conference, San Diego, Nov. 13-16, 1994 (ASCE)*, p.131.
- ⁷¹ L.C. Muszynski and R.L. Sierakowski, "Durability of Darbon Fiber Reinforced Plastics (CFRPs) as External Reinforcement of Concrete Beams", 50th Annual Conference, 50th Annual Conference, Composites Institute, p. 4-C/1, 1995.

-
- ⁷² M. Xie, V. Hoa and X.R. Xiao, "Bonding Steel Reinforced Concrete with Composites", *J. of Reinforced Plastics and Composites*, 14, 949 (1995).
- ⁷³ T.C. Triantafillou, N. Deskovic and M. Deuring, "Strengthening of Concrete Structures with Prestressed Fiber Reinforced Plastic Sheets", *ACI Structural Journal*, 89(3), p. 235.
- ⁷⁴ M.J. Chajes, T.A. Thomson, T.F. Januszka and W.W. Finch, Jr., "Flexural Strengthening of Concrete Beams Using Externally Bonded Composite Materials", *Construction and Building Materials*, 8(3), 191 (1994).
- ⁷⁵ M.J. Chajes, T.A. Thomson and C.A. Farschman, "Durability of Externally Bonded Composite Material Reinforcement", *Construction and Building Materials*, 9(3), 141 (1995).
- ⁷⁶ S.B. Shulley, X. Huang, V.M. Karbhari and J.W. Gillespie, Jr., "Fundamental Considerations of Design and Durability in Composite Rehabilitation Schemes for Steel Girders with Web Distress", p. 1187, *Infrastructure: New Materials and Methods of Repair, Proceedings of the Third Materials Engineering Conference*, San Diego, Nov. 13-16, 1994 (ASCE).
- ⁷⁷ R. Sen, L. Liby, K. Spillett, G. Mullins, "Strengthening Steel Composite Bridge Members Using CFRP Laminates", p. 551, *Non-metallic (FRP) Reinforcement for Concrete Structures*, L. Taerwe, ed., RILEM, 1995.
- ⁷⁸ V.M. Karbhari and S.B. Shulley, "Use of Composites for Rehabilitation of Steel Structures-Determination of Bond Durability", *Journal of Materials in Civil Engineering*, 7(4), 239 (1995).
- ⁷⁹ M.J. Chajes, V.N. Kaliakin, S.D. Holsinger and A.J. Meyer, Jr., "Experimental Testing of Composite Wood Beams for use in Timber Bridges", *Transportation Research Record B4130, 4th International Bridge Engineering Conference*, vol. 2, 371 (1995).
- ⁸⁰ E. Barbero, J. Davalos and U. Munipalle, "Bond Strength of FRP-Wood Interface", *J. Reinforced Plastics and Composites*, 13, 835 (1994).
- ⁸¹ T. C. Triantafillou and M. Deskovic, "Prestressed FRP Sheets as External Reinforcement of Wood Members", *Journal of Structural Engineering*, 118(5), 1270 (1992).
- ⁸² H. Saadatmanesh, "Wrapping with Composite Materials", p. 593, *Non-metallic (FRP) Reinforcement for Concrete Structures*, L. Taerwe, ed., RILEM, 1995.
- ⁸³ H. Saadatmanesh, "Fiber Composites for New and Existing Structures", *ACI Structural Journal*, 91(3), 346 (1994).
- ⁸⁴ A. Nanni and N.M. Bradford, "FRP jacketed concrete under uniaxial compression", *Construction and Building Materials*, 9(2), 115 (1995).
- ⁸⁵ G. Schwegler, "Masonry Construction Strengthened with Fiber Composites in Seismically Endangered Zones", *10th European Conference on Earthquake Engineering*, Vienna, Austria, 1994.

-
- ⁸⁶ "Joining Polymeric Composites, Adhesives" in *International Encyclopedia of Composites*, vol. 2, S.M. Lee, ed., p. 509 (VCH Publishers, 1990).
- ⁸⁷ F.L. Matthews in *Joining Fibre-reinforced Plastics*, F.L. Matthews, ed., p. 1 (Elsevier Applied Science Publishers, 1987).
- ⁸⁸ R.W. Messler, *Joining of Advanced Materials* (Butterworth-Heinemann, 1993).
- ⁸⁹ A.S. Mosallam, "Connections for Pultruded Composites: A Review and Evaluation", p. 1001, *Infrastructure: New Materials and Methods of Repair, Proceedings of the Third Materials Engineering Conference*, San Diego, Nov. 13-16, 1994 (ASCE).
- ⁹⁰ J.R. Vinson, "Adhesive Bonding of Polymer Composites", *Polym. Eng. Sci.*, **29**(19), 1325 (1989).
- ⁹¹ D.S. Saunders, S.C. Galea and G.K. Diermendjian, "The Development of Fatigue Damage around Fastener Holes in Thick Graphite/Epoxy Composite Laminates", *Composites*, **24**(4), 309 (1993).
- ⁹² "Joining, Mechanical Fastening" in *International Encyclopedia of Composites*, vol. 2, S.M. Lee, ed., p. 438 (VCH Publishers, 1990).
- ⁹³ J.W. Chin and J.P. Wightman, "Surface Pretreatment and Adhesive Bonding of Carbon Fiber-reinforced Epoxy Composites", *ASTM STP 1227*, p. 1, American Society for Testing and Materials, 1994.
- ⁹⁴ D.J.D. Moyer and J.P. Wightman, "The Effect of Surface Pretreatment on Carbon Fiber-Polyimide Matrix Composite Bonding", *Surf. Interface Anal.*, **17**, 457 (1991).
- ⁹⁵ B.M. Parker and R.M. Waghorne, "Testing Epoxy Composite Surfaces for Bondability", *Surf. Interface Anal.*, **17**, 471 (1991).
- ⁹⁶ R.F. Wegman, *Surface Preparation Techniques for Adhesive Bonding*, p. 109 (Noyes Publications, 1989).
- ⁹⁷ J.R.J. Wingfield, *Int. J. Adhes. Adhes.*, **13**(3), 151 (1993).
- ⁹⁸ A.J. Kinloch, "Fibre Composites - Joining", *Handbook of Adhesion*, D.E. Packham, ed., p. 167 (Longman Group UK Ltd., 1992).
- ⁹⁹ E. Occhiello, M. Morra, G.L. Guerrini and F. Garbassi, "Adhesion Properties of Plasma-treated Carbon/PEEK Composites", *Composites*, **23**(3), 193 (1992).
- ¹⁰⁰ S.-I. Y. Wu, "Adhesive Bonding of Thermoplastic Composites: 2. Surface Treatment Study", *Proceedings of the 35th International SAMPE Symposium*, **35**, 846 (1990).

-
- ¹⁰¹ A.J. Kinloch, G.K.A. Kodokian and J.F. Watts, "Relationships Between the Surface Free Energies and Surface Compositions of Thermoplastic Fibre Composites and Adhesive Joint Strengths", *J. Mater. Sci. Lett.*, **10**, 815 (1991).
- ¹⁰² E. Wurzberg, A. Buchman, E. Zylberstein, Y. Hodengraber and H. Dodiuk, "Preadhesion Laser Surface Treatment of Polycarbonate and Polyetherimide", *Int. J. Adhes. Adhes.*, **10**(4), 254(1990).
- ¹⁰³ J.M. Marinelli and C.L.T. Lambing, "A Study of Surface Treatments for Adhesive Bonding of Composite Materials", *Proceedings of the 38th International SAMPE Symposium*, **38**, 1196 (1993).
- ¹⁰⁴ D.K. McNamara, H.M. Hand and C. Arah, "Surface Preparation Techniques for Improved Adhesive Bonding to Graphite/Epoxy Composites", *Proceedings for the 6th International Symposium on Structural Adhesives Bonding*, 1992.
- ¹⁰⁵ H.G. Melhem and J.R. Schlup, "Usage of Adhesives and Composites in Highway Structures", p. 983, *Infrastructure: New Materials and Methods of Repair, Proceedings of the Third Materials Engineering Conference*, San Diego, Nov. 13-16, 1994 (ASCE).
- ¹⁰⁶ J.T. Mottram, "Short- and Long-Term Structural Properties of Pultruded Beam Assemblies Fabricated Using Adhesive Bonding", *Composite Structures*, **25**, 387 (1993).
- ¹⁰⁷ F. Gordaninejad, M.S. Saiidi and N. Wehbe, "Behavior of Adhesively Bonded Concrete-Graphite/Epoxy Composite Bridge Girders", *Journal of Advanced Materials*, p. 47, Jan. 1994.
- ¹⁰⁸ L.M. Bates, "Graphite Composites Come Under Scrutiny", *Plastics World*, p. 82, August 1991.
- ¹⁰⁹ J. Boyd, S. Speak and P. Sheahan, "Galvanic Corrosion Effects On Carbon Fiber Composites: Results from Accelerated Tests", *Proceedings of the 37th International SAMPE Symposium*, **37**, 1185 (1992).
- ¹¹⁰ M.L. Rommel, A.S. Postyn and T.A. Dyer, "Accelerating Factors in Galvanically Induced Polyimide Degradation", *SAMPE Journal*, **29**(2), 19 (1993).