

**Warping of Terrace Pavers at the U.S.  
Capitol Building**

---

---

Chiara F. Ferraris  
Paul Stutzman  
James Clifton

May 1996  
Building and Fire Research Laboratory  
National Institute of Standards and Technology  
Gaithersburg, MD 20899



**National Institute of Standards and Technology**  
Michael Kantor, *Secretary*  
**Technology Administration**  
Mary L. Good, *Under Secretary for Technology*  
**National Institute of Standards and Technology**  
Arati Prabhakar, *Director*

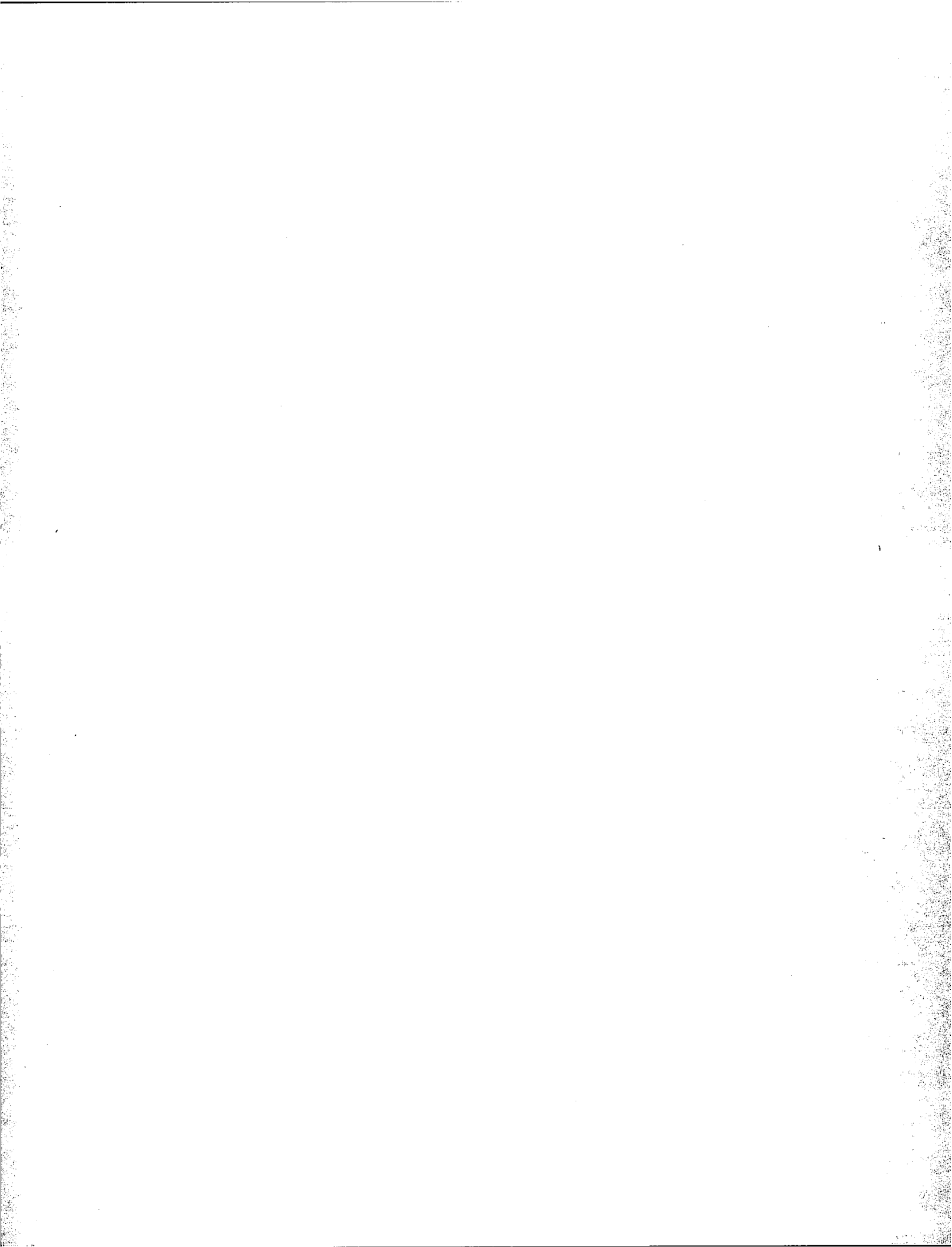

## **Abstract**

The terraces of the U.S. Capitol are covered with cement-based pavers designed to emulate the granite pavers used elsewhere on the Capitol grounds. The pavers were warped after three years of service. These pavers are composed of two layers; an upper, decorative white-cement-based mortar with crushed micaceous quartz aggregate supported by a base of conventional concrete. Field inspection and laboratory testing indicates the warping is probably due to the high cement content, environmental exposure conditions, and possibly differences in hydraulic length changes of two layers comprising the pavers. A cement content of nearly twice that found in typical concretes, leads to higher levels of moisture-driven swelling and shrinkage. This coupled with the different exposure environments of the two materials, i.e., higher relative humidity under the paver and faster drying on the top of the paver, and the differential hydraulic length changes of the two materials used in the pavers leads to warping. Alkali-silica reactivity (ASR) tests indicate that the base layer aggregate is marginally reactive and the upper layer aggregate is non-reactive. While some reaction products were observed in the base layer, expansion due to alkali-silica reaction was not thought to be a significant cause of the warping of the pavers.

### **Keywords:**

aggregate, alkali-silica reaction, cement, concrete, construction materials, expansion, pavers, warping.

# Table of Contents

<b>1. Introduction.....</b>	<b>1</b>
<b>2. Field Inspection .....</b>	<b>2</b>
2.1. Specimen examination .....	3
<b>3. Sampling of the Pavers.....</b>	<b>4</b>
<b>4. Laboratory Tests and Results .....</b>	<b>5</b>
4.1. Thermal Expansion .....	5
4.2. Shrinkage/Expansion Due to Water Absorption .....	6
4.3. Water Absorption .....	8
4.3.1. <i>Capillary Absorption</i> .....	8
4.3.2. <i>Water absorption capacity</i> .....	11
4.4. Compressive and Flexural Strength.....	11
4.5. Alkali-Silica Reaction .....	11
4.5.1. <i>Introduction</i> .....	11
4.5.2. <i>Test Design</i> .....	12
4.5.3. <i>Results</i> .....	13
4.5.4. <i>SEM observation</i> .....	14
4.6. Whole Pavers .....	14
<b>5. Summary and Conclusion .....</b>	<b>17</b>
<b>6. Acknowledgments.....</b>	<b>18</b>
<b>7. References.....</b>	<b>18</b>
<b>Appendix I .....</b>	<b>20</b>

## Table of Figures

Figure 1: View of the terrace.....	1
Figure 2: Schematic of paver installation.....	2
Figure 3: Picture of the section of a paver.....	3
Figure 4: Overlay cross section.....	5
Figure 5: Thermal expansion of saturated samples between 10 and 50 °C.....	6
Figure 6: Expansion coefficients for the specimens at 1%RH. ....	6
Figure 7: Expansion and shrinkage of in-service pavers due to water absorption or desorption in laboratory experiments. The two layers were tested alone. ....	7
Figure 8: Capillary absorption test configuration.....	8
Figure 9: Definition of the surfaces measured for capillary absorption.....	9
Figure 10: Capillary absorption; A) substrate (S); B) overlay top (OT); C) overlay base (OB). (errors-bars are one standard deviation).....	10
Figure 11: ASR expansion measured by modified ASTM C 227.....	13
Figure 12: ASR expansion measured by modified ASTM C 1260.....	14
Figure 13: Experimental configuration for measuring deformation of a new paver.....	16
Figure 14: Paver warping vs. time. A and B denote two different pavers.....	17

## List of Tables

Table 1: Sorptivity coefficients and total porosity.....	9
Table 2: Compressive and Flexural Strength.....	11
Table 3: Mixture design for ASR measurements in 1N NaOH solution.....	12
Table 4: Sand gradation for mixture from Table 3.....	12

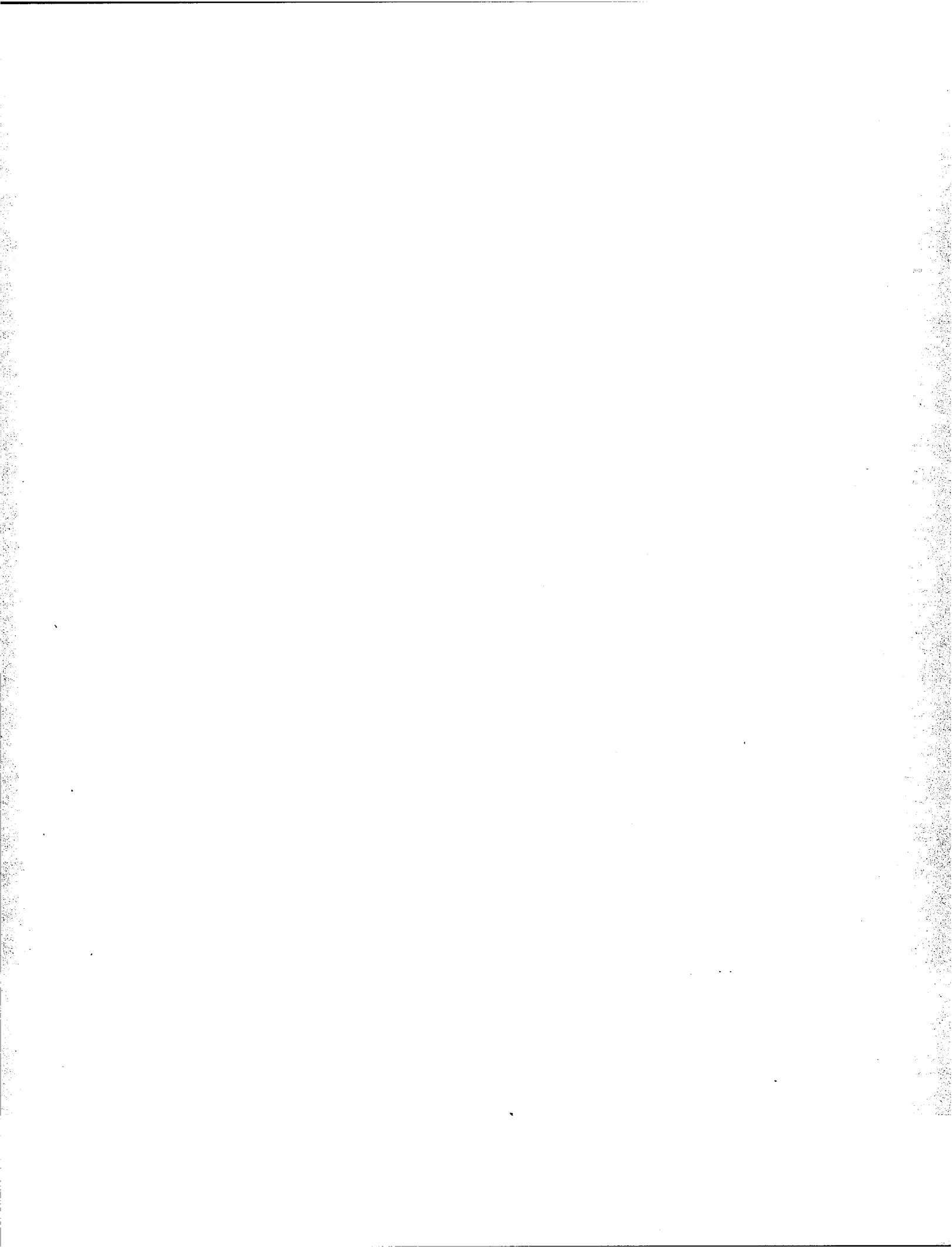

## 1. Introduction

The terraces of the U.S. Capitol are covered with pavers (1219 x 614 X 64 mm, 4 ft. x 2 ft. x 2.5 in.) designed to imitate the historic granite pavers used elsewhere on the Capitol grounds. These pavers are composed of two layers: a base of conventional concrete and an upper layer of white-cement-based mortar. These pavers were installed in 1992 and after three years exhibited warping (Figure 1).

A field inspection allowed assessment of the problem. A series of laboratory tests was performed on pieces sampled from the pavers as well as the whole pavers. Pavers taken from the Capitol terrace ("in-service") and "new" pavers were used in the tests. "New" pavers are from the same batch as the ones "in-service" but were stored in a warehouse, sheltered from the weather. "New" pavers do not exhibit the warping seen in the in-service pavers. The tests performed were:

1. thermal expansion
2. drying shrinkage and swelling during water immersion
3. water absorption by capillary suction, i.e., one surface exposed to water, and by total immersion
4. compressive and flexural strength,
5. Alkali-silica reaction (ASR) expansion by two methods, i.e., ASTM C 1260 and ASTM C227, and
6. whole pavers testing under simulated field conditions

These tests were able to simulate field conditions and to characterize the materials used regarding strength and reaction with water. Combining all the results, it was possible to determine the reasons of the warping of the pavers.



**Figure 1: View of the terrace**

## 2. Field Inspection

In June 1995, a visit was made to the terrace of the U.S. Capitol at the request of Mr. James Krapp (Project Manager of the Office of the Architect of The Capitol). The terrace pavers were placed in 1992, with some replaced at a later date because they were curled. Nevertheless, all pavers were warped (Figure 1) and a few were broken or cracked. The warping was not visible on the shorter, half-length pavers, such as those placed at the end of each row. The size of a paver should affect the amount of curling, with curling increasing with the size[1].

Figure 2 shows a typical installation with each paver being supported by six cylindrical plastic studs. Each stud is shared with neighboring pavers (Figure 2). During the inspection, it was found that the pavers seemed to be resting only on the two middle studs and being elevated from the other four studs. The vertical displacement at the ends was about 15-20 mm from the stud. If it is assumed that the paver curled in a circular arc (an approximation) the bottom surface expanded by about 0.03 - 0.05 %. According to Mr. Krapp, none of the supports were missing or displaced.

The pavers are composed of two layers (see Figure 3). The top layer referred as "overlay" in this paper, is a proprietary formulation of mortar to match the color and texture of granite pavers used elsewhere on the terraces. The bottom layer referred to as "substrate", in this report, is a conventional concrete. It is likely that the sole purpose of the substrate is to add rigidity to the paver while minimizing costs by reducing the thickness of the overlay. The exact composition of each layer was not provided because it is considered proprietary by the manufacturer.

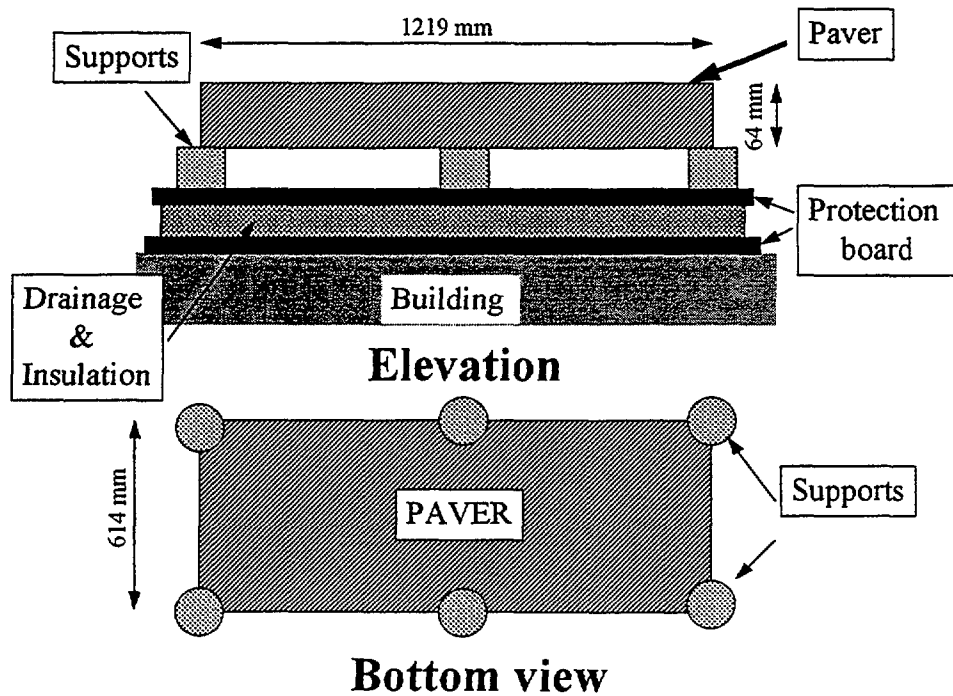
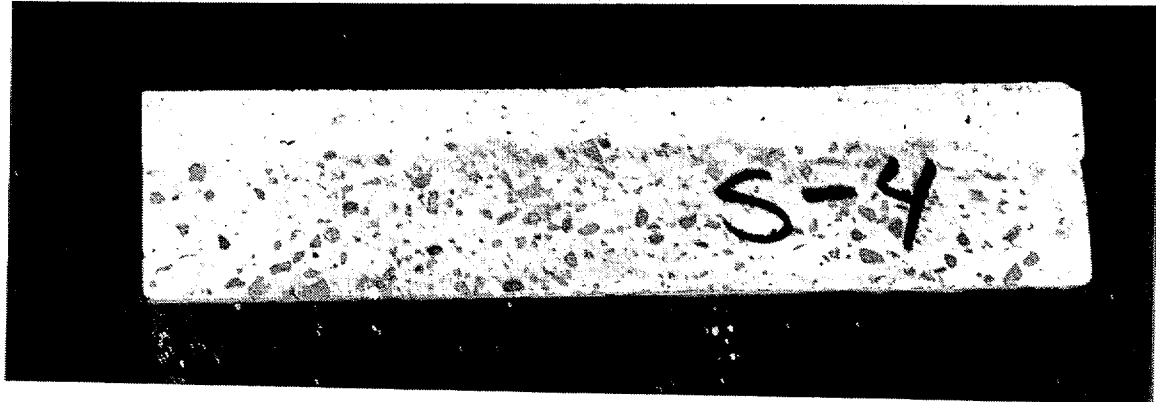

Figure 2: Schematic of paver installation





**Figure 3: Picture of the section of a paver**

### **2.1. Specimen examination**

Three samples were taken during the visit at the U.S. Capitol, and prepared for petrographic examination. The first sample (about 50 mm x 50 mm) had been in service and was replaced because of a brown stain on the surface. The brown stain was attributed to the water from a rusted spout. A second and third samples were cut and sectioned from a cross section of an in-service paver for Scanning Electron Microscopy (SEM) (100 mm x 60 mm) and for stereo microscope (300 mm x 60 mm). The SEM samples were oven dried at 60 °C, epoxy-impregnated and polished using 0.25 µm diamond paste. The sample for stereo microscope examination was ground flat, and lapped using 400 grit emery paper to prepare a surface suitable for examination. The detailed observations for both layers follows.

#### Overlay

The overlay, or top light-colored layer of the pavers, is composed of a micaceous, crushed quartz aggregate in a white cement matrix. White cements lack the calcium aluminoferrite phase which gives portland cement its gray coloring. Thickness of the overlay ranges from 5 mm to 20 mm in the samples prepared for petrographic examination. The aggregate exposed on the wearing surface gives an appearance of a light-colored, speckled granite. The cement paste is uniformly distributed, dense-appearing, with no entrained air, and little entrapped air. Few microcracks were observed, and no alkali-aggregate reaction gel was seen. The surface discoloration of the sample obtained near the down spout is due to a film of iron oxide coating on the surface of the exposed aggregate and cement paste.

### Bottom Layer

The substrate is composed of a portland cement paste with a siliceous aggregate. The coarse aggregate is predominantly quartz with some feldspathic granite, chert, sandstone, and shale. The fine aggregate is predominantly quartz sand. Both the coarse and the fine aggregates are rounded to sub-angular river gravels. No entrained air and little entrapped air was observed. Incomplete homogenization of the aggregate and cement paste is evident as many coarse aggregate particles are enveloped with cement paste, and some cement paste lenses occur within the microstructure. Microcracking may occasionally be seen, especially near the cement-paste-rich zones. Cracks in the base extending about 20 mm upward are common in the in-service paver cross-sections. They could be due to the curling of the pavers. Little ASR reaction gel was seen, though a few chert grains in the coarse aggregate exhibited reaction rims. In addition, a few sugary-textured, eroded grains were observed. It was not clear if these grains were friable or degraded due to paste/aggregate reaction.

### **3. Sampling of the Pavers**

Ten pavers were selected by Mr. Krapp and shipped to the National Institute of Standards and Technology (NIST) for laboratory testing. Five "in-service" pavers were taken from the terrace while five "new" pavers were taken from the warehouse. All pavers were thought to be produced at about the same time and using the same mixture design. Appendix I shows the location from which the in-service pavers were taken.

All five in-service pavers were badly warped while none of the new pavers were warped. Three pavers of each set, i.e., in-service and new, were cut in 4 equal sections (609.5 mm x 307 mm) using a saw and then as needed further sawed to the size needed for the tests to be performed (see Section 4). Two of the new pavers were reserved to simulate the field conditions (section 4.6). It was noted that the thickness of the overlay is not uniform as shown on Figure 4.

Three types of specimens were tested:

1. The overlay alone, i.e., separated from the substrate by sawing,
2. The substrate alone, i.e., separated from the overlay by sawing, and
3. The overlay and the substrate as received, i.e., not separated from each other.

The preparation of specimens to be tested as "overlay alone" or as "substrate alone" required two steps:

1. a specimen was sawed from a paver to the desired size
2. the specimen obtained was sawed along the interface of the two layers.

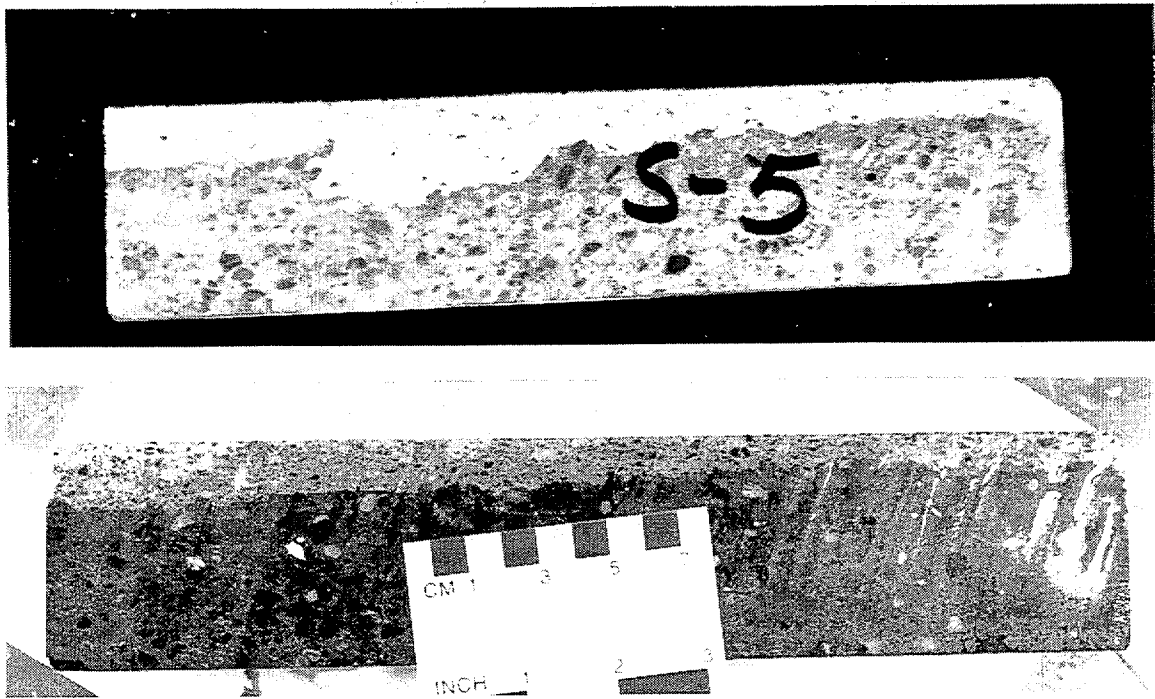
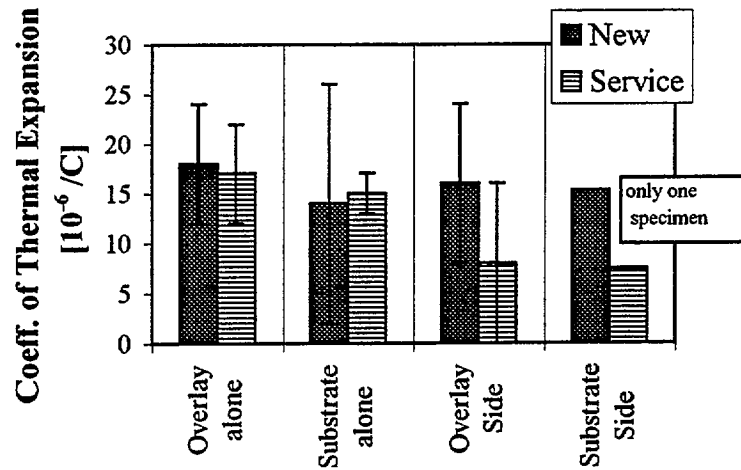

Figure 4: Overlay cross section

## 4. Laboratory Tests and Results

### 4.1. Thermal Expansion

Thermal expansion was measured by placing the samples in an environmental chamber and cycling the temperature while regularly measuring the expansion. Two humidity conditions were considered: in water and at about 1% RH. In the first case, the samples were saturated and kept in water while the temperature was changed. In the second case, the samples were placed in an environmental chamber and the relative humidity was kept constant at about 1%. Figure 5 and Figure 6 show the results obtained from saturated samples and dry samples, respectively. The large standard deviation is due to the difficulty of finding a stable adhesive to attach pins to the sample at all temperature and humidities. The pins were the reference points between which the expansion was measured. The pins were placed on the long side of the specimen. The three type of specimens, described in Section 3, were tested. In the specimens in which the overlay and substrate were not separated, pins were placed on two sides, i.e. the substrate and the overlay. The purpose was to determine if any warping could be observed. Each set included three specimens. The tests were conducted until constant length. Considering the large standard deviation, there appears to be no significant difference between the two materials.



**Figure 5: Thermal expansion of saturated samples between 10 and 50 °C.**  
Average of 3 samples. (errors-bars are one standard deviation)

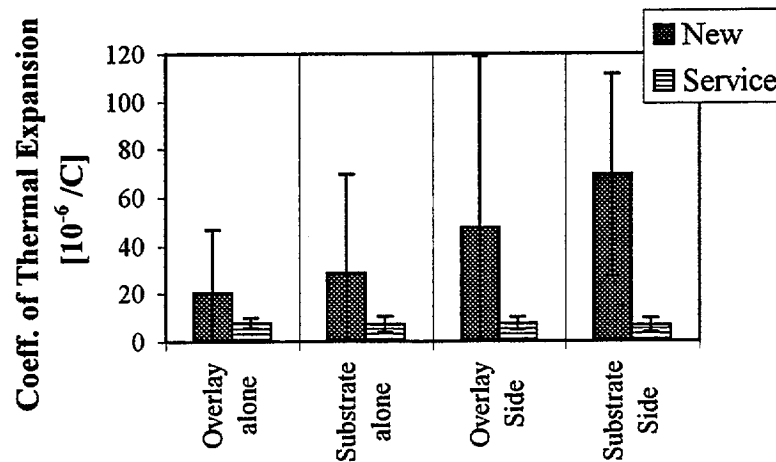

**Figure 6: Expansion coefficients for the specimens at 1%RH.**  
Results average of 4 sets of data. Temperature cycled between 10 and 75 °C.  
(errors-bars are one standard deviation)

#### 4.2. Shrinkage/Expansion Due to Water Absorption

Prism specimens were sawed from the pavers. The dimensions of the prisms were 25 x 276 mm x 15 mm for the overlay and 25 x 276 mm x 45 mm for the substrate. To determine the length changes from wetting and drying, the bars were placed in water for about 50 days, then air dried on the laboratory bench to constant length. The laboratory was at 20 °C ± 3 °C and the RH varied from 21 % to 40 %. The length changes were measured using a digital strain gauge after pins were attached to the specimen longer sides. Figure 7 shows the expansion and shrinkage characteristics of the substrate relative to the overlay.

The substrate shrank and expanded more than the overlay. The value found are about 2-3 time larger than the value estimated in the field inspection (0.03 % to 0.05%). It

should be considered that the laboratory experiment were conducted on materials separated from each other, i.e., free to expand or shrink. Therefore, the curling in the field is a combination of the different expansion (shrinking) of the two materials.

Shrinkage of concrete is primarily associated with moisture loss, autogenous shrinkage due to cement hydration, and to carbonation of cement hydration products [2]. The pavers appear to be rich in cement which suggests they also have a high water content and thus should be susceptible to high drying shrinkage strains [3]. To avoid shrinkage, it is recommended to have a high proportion of coarse aggregates of the maximum size possible, which will help to reduce the water content of the concrete [4].

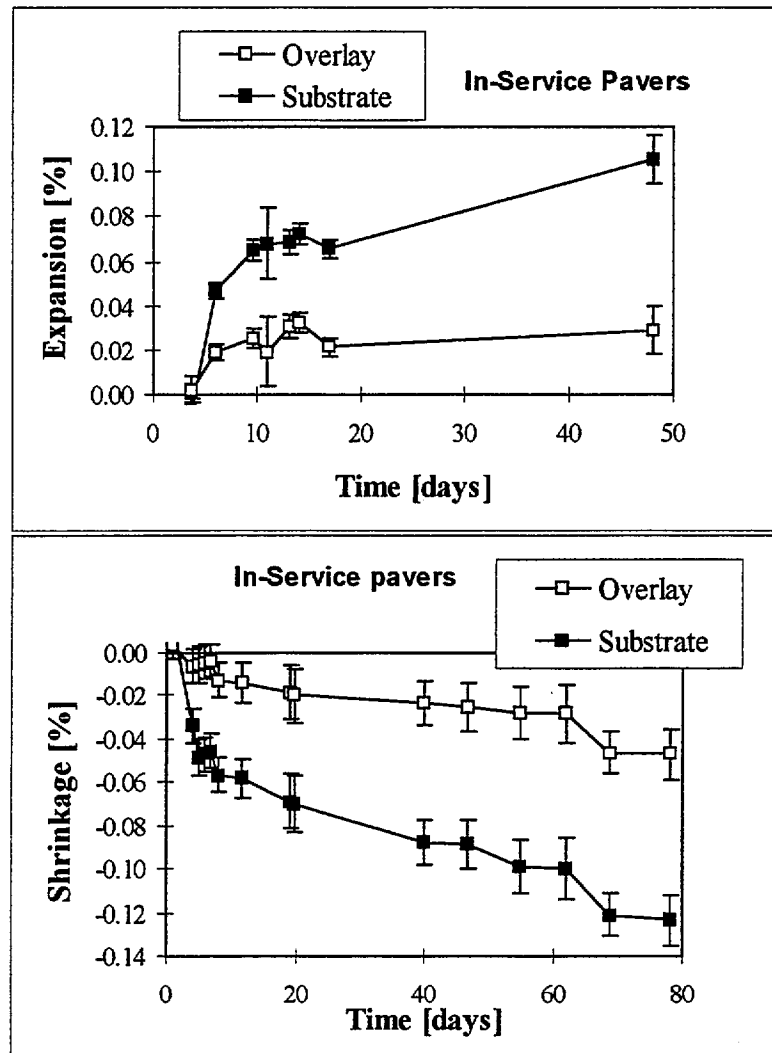

**Figure 7: Expansion and shrinkage of in-service pavers due to water absorption or desorption in laboratory experiments. The two layers were tested alone. (Results average of 3 specimens. The error-bars are one standard deviation).**

### 4.3. Water Absorption

Water absorption was measured in two ways: capillary absorption by exposure to water on a face only and full immersion. All tests were conducted on small samples sawed from the pavers, the approximate dimension were 75 mm x 75 mm section, the height being the pavers' thickness. Tests were performed on specimens composed of only one of the layers, i.e., overlay or substrate.

#### 4.3.1. Capillary Absorption

The capillary absorption was measured by placing the sample in contact with water only on one surface (see Figure 8). The samples were oven dried at 50 °C until constant mass. The sides of the specimen were covered with tape to minimize ingress or evaporation of water and vapor. The mass of the sample was determined 4 times during the first hour, every hour between 1 and 7 hours and then every week. The mass gain per unit surface area versus time is used to calculate the rate of absorption or sorptivity.

The two surfaces, that in the field are exposed to water (the substrate (S) and the overlay top (OT) Figure 9), are more likely to absorb water than the interface (OB). The results from the capillary absorption are on Table 1 and Figure 10. Table 1 shows the sorptivity values while Figure 10 shows the water absorbed by unit of surface. It is clear that there are some differences between the new and in-service pavers. The new pavers, in general, absorbed more than the in-service pavers. This difference could be a sign of an aging effect on the pavers due to weather conditions. The sorptivity coefficients are comparable to conventional concretes [about (8 to 20)  $10^{-6}$  m/ $\sqrt{\text{sec}}$ . [5,6]].

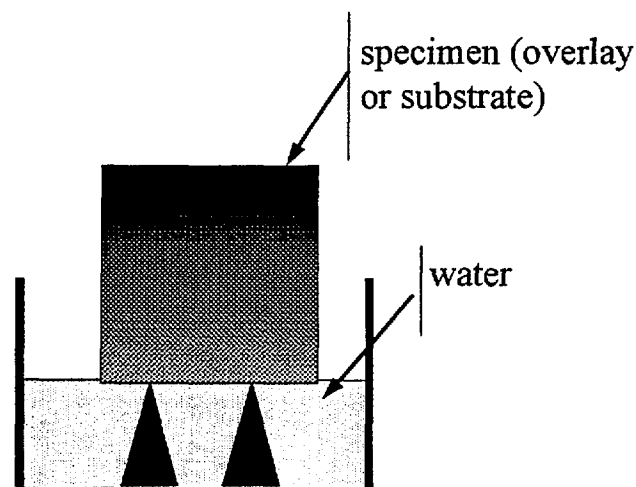
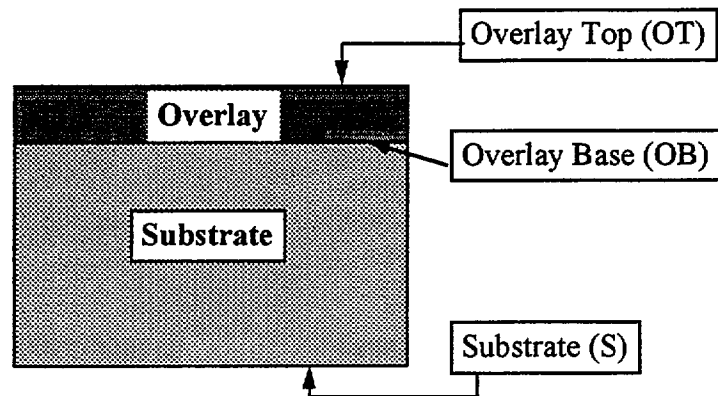

Figure 8: Capillary absorption test configuration.



**Figure 9: Definition of the surfaces measured for capillary absorption**

**Table 1: Sorptivity coefficients and total porosity**

Specimen type		Sorptivity <sup>a</sup> [10 <sup>-6</sup> m/ $\sqrt{\text{sec.}}$ ]	Total water content <sup>b</sup> [%]
Substrate:	New	12	3.6 ± 0.1
	In-service	6	4.6 ± 0.03
Overlay; top (OT):	New	8	
	In-service	7	
Overlay; base (OB):	New	14	3.7 ± 0.2
	In-service	8	4.1 ± 0.1

Notes:  
a) The total R<sup>2</sup> varies from 90 to 99% for sorptivity measurements. Average of 2 specimens  
b) Results on water absorption are an average of 2-3 specimens. ± one standard deviation

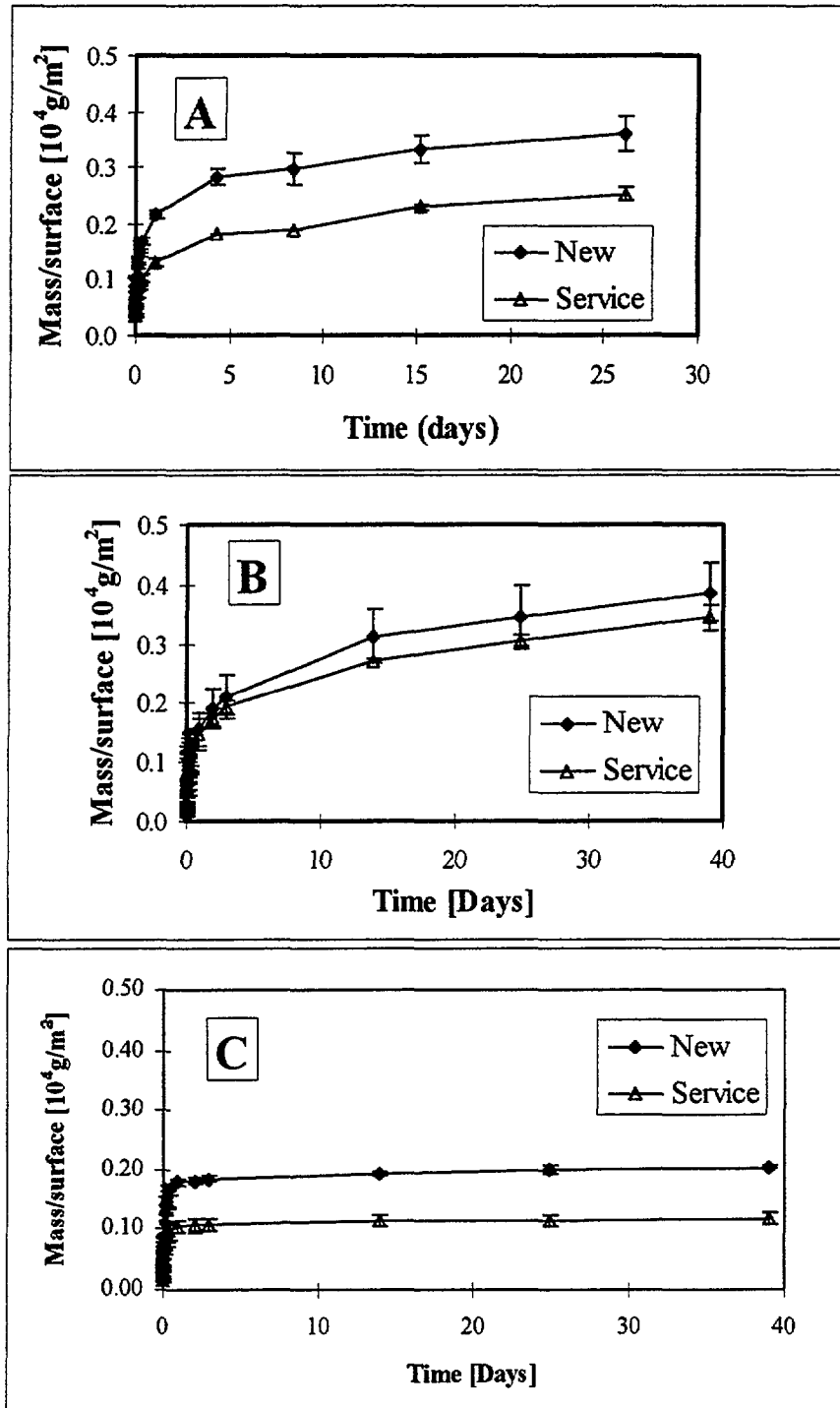

Figure 10: Capillary absorption; A) substrate (S); B) overlay top (OT); C) overlay base (OB). (errors-bars are one standard deviation)



### 4.3.2. Water absorption capacity

The water absorption capacity was measured by drying the sample in an oven at 50 °C until constant mass and then gradually (1/3 of the specimen height each day) immersing the sample in water until constant mass. The ratio between the mass of water absorbed (wet mass minus the dry mass) and the dry mass is a measure of the water absorption capacity of the sample (Table 1). Again, a difference is seen between the new and in-service pavers with the in-service substrate being more porous than the overlay. This difference reflects additional void space due to cracking of the substrate of the in-service pavers.

### 4.4. Compressive and Flexural Strength

The compressive and flexural strength were measured following procedures in ASTM C 109 [7] and ASTM C 293 [8], respectively. For the compressive strength the cubes were tested using neoprene pads to compensate for the non-planar surfaces (Table 2).

The compressive and flexural strength measured are adequate for pavers because the minimum requested (according ACI 302 [9]) is 27.6 to 31.0 MPa. The compressive strength of the pavers and their modulus of rupture (flexural strength) are not significantly modified by exposure to outdoor weather conditions.

**Table 2: Compressive and Flexural Strength**

Sample	Compressive strength MPa (psi)		Modulus of Rupture MPa (psi)	
	New Pavers	Pavers in-service	New Pavers	Pavers in-service
Overlay alone			10.2 ± 1 (1480)	10.0 ± 1.5 (1450)
Substrate alone	64 ± 7 (9280)	67 ± 9 (9720)	8.1 ± 1 (1170)	6.3 ± 0.5 (914)
Pavers as received <sup>a</sup>	61 ± 2 (8850)	59 ± 13 (8560)	6.5 ± 0.6 (943)	6.2 ± 0.2 (900)

Note: a) The substrate and the overlay were not separated.  
b) The errors are calculated as a one standard deviation  $\sigma$ .

### 4.5. Alkali-Silica Reaction

#### 4.5.1. Introduction

The alkali-silica reaction (ASR) tests were performed following two methods: a modified ASTM C 227 [10] and ASTM C1260 [11]. The first method involves measurements of the length changes of specimens stored at 100% RH and 38 °C. The second method measures the length changes of specimens placed in 1N NaOH at 80 °C. The second method is usually selected because it gives faster results, while the first method is more comparable with field conditions.

Results indicate a potential for ASR in the substrate. This was consistent with petrographic analysis by SEM and X-ray imaging which indicated some regions of ASR reaction gel .

## 4.5.2. Test Design

### 4.5.2.1. Test on pavers as received

ASTM C227 [10], requires that the specimens be placed in a 100 % RH at 38 °C while length changes are measured. The modifications adopted are that a temperature of  $20 \pm 3$  °C was used, i.e., the room temperature. This will more than likely lengthen the duration of the test. The second modification is that pins were attached with epoxy (not imbedded as required by the standard) on the side of the specimens.

### 4.5.2.2. Tests on ground pavers

An attempt was made to test the samples as received according to ASTM C1260 [11]. Unfortunately, as it was not possible to find an epoxy that resists 80 °C and 1N NaOH, reference pins could not be attached to the samples, and therefore, it was not possible to measure expansion directly. The method below was developed.

Samples of the pavers were ground to the particle size distribution described in ASTM C1260 [11] and cast as the sand portion in mortar bars ( 25 mm x 25 mm x 275 mm , 1 in. x 1in. x 11 in) using an ASTM Type I cement. The overlay material was separated from the substrate allowing individual testing of the individual aggregates. Table 3 shows the mortar bar mixture design. The specimens were cured for the first 24 hours in their molds at  $20 \pm 3$  °C and 100 % RH. After curing, the specimens were demolded and placed in water in an oven at 80 °C. After 24 hours in the oven the water was replaced with 1N NaOH solution. The length was measured regularly from the time of demolding.

**Table 3: Mixture design for ASR measurements in 1N NaOH solution**

Material	Amounts [g]	Mass ratio to cement
Cement	440	--
Sand	990	2.25
Water	206.8	0.47

**Table 4: Sand gradation for mixture from Table 3**

Sieve		Percentage [%]
Number (ASTM E 11 [12])	Size [mm]	
6	3.35	0
8	2.36	10
16	1.18	25
30	0.60	25
50	0.30	25
100	0.15	10

### 4.5.3. Results

After six months testing, it may be too early to make a definite conclusion from the modified ASTM C227 test. Nevertheless, the appendix of ASTM C33 [13] states that the expansion is excessive if it exceeds 0.05% at 3 months or 0.1% at 6 months. Figure 11 shows that the expansion is below 0.1% at 6 months. Of course, the lower temperature (only 20 °C instead of 38 °C) might have slowed the reaction, and delayed the expansion. The specimens will be measured for another 6 months at least. Nevertheless, the expansion data show that the substrate expands more than the overlay for both the new and in-service pavers. This indicates that if any reactions do occur the substrate will expand more than the overlay leading to an upward deformation of the paver.

The samples will also be sawed and examined by a scanning electron microscope (SEM) for detection of reaction products.

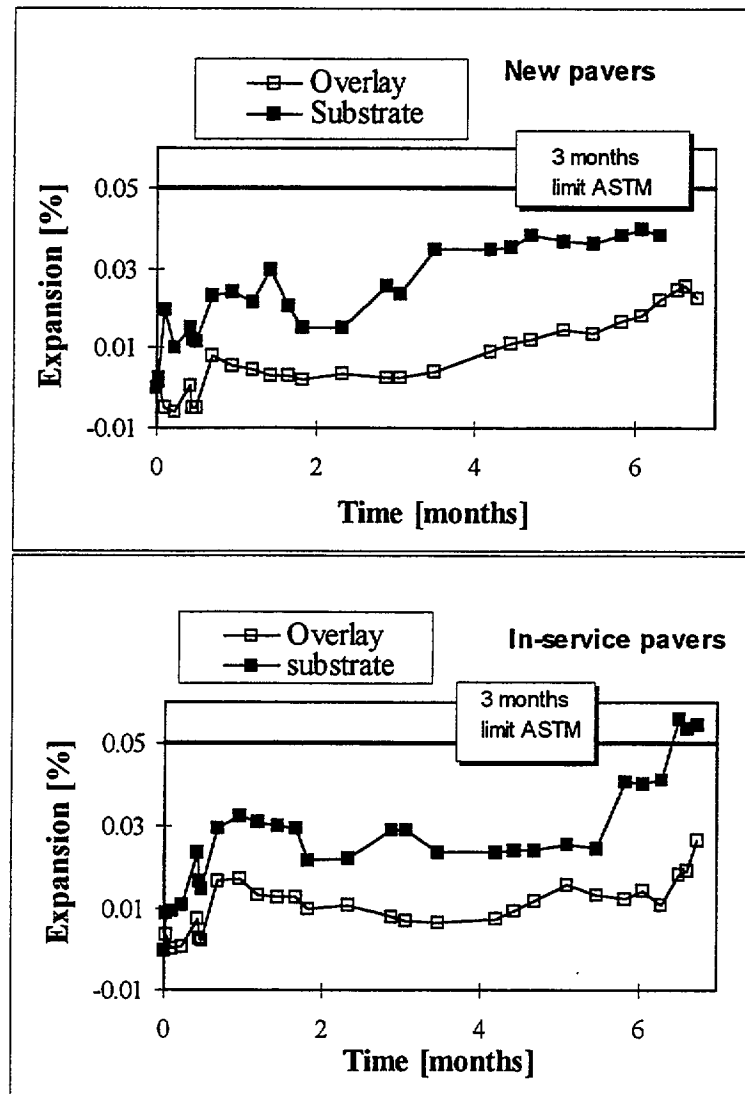

Figure 11: ASR expansion measured by modified ASTM C 227

According to ASTM C 1260, the deleterious behavior of an aggregate is determined by the expansion of the specimen in the following range:

- “safe” if the expansion is less than 0.1% at 14 days
- “marginally safe” if the expansion is between 0.1% and 0.2 % at 14 days
- “deleterious” if the expansion is above 0.2% at 14 days.

Figure 12 shows that there are no deleterious aggregates, because at 14 days none of the specimens had expanded above 0.1%. Nevertheless, the substrate specimen showed a continuing increase that eventually lead to an expansion above 0.1%, but some time after 14 days. The overlay does not follow the same trend. Therefore it could be argued that if some expansion occurs due to ASR in the substrate and not in the overlay, the differential expansion in the two materials could contribute to warping. Before considering that the substrate contains deleterious aggregates, it should also be remembered that this test was on ground material from the substrate as aggregates and not on the substrate as received.

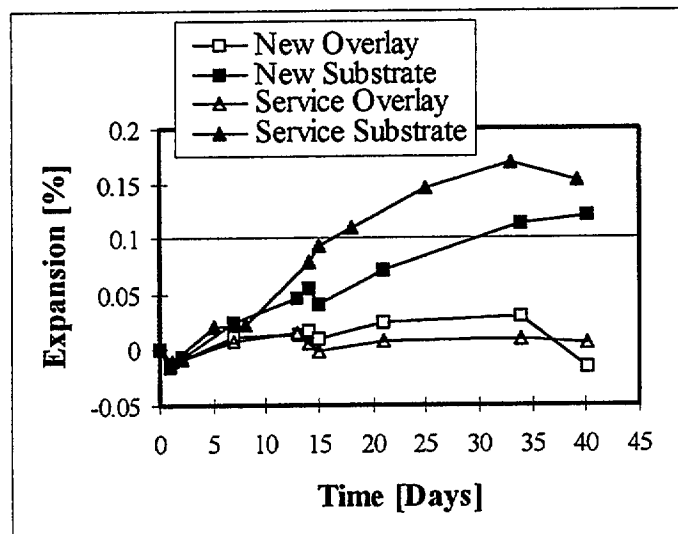

Figure 12: ASR expansion measured by modified ASTM C 1260

#### 4.5.4. SEM observation

The samples tested using the modified ASTM C 1260, were sawed at the end of the test for observation by SEM. Examination of these samples using backscattered electron and X-ray imaging showed a small amount of cracking and reaction product in mortar bars cast using material from the base of the pavers. The reaction appears to be related to the chert and polycrystalline quartz aggregate based on cracking patterns and concentration of reaction gel. Mortar bars using material from the upper layer, consistent with the expansion data, did not show any cracking or reaction gel.

#### **4.6. Whole Pavers**

A severe simulated exposure test was devised to measure the degree and rate of warping of two new pavers selected from warehouse storage. The pavers were placed on supports, as in the field, and the apparatus maintained a top surface temperature of about  $45\text{ }^{\circ}\text{C} \pm 3\text{ }^{\circ}\text{C}$  while 100% RH (standing water) was maintained under the paver. The laboratory conditions are  $25\text{ }^{\circ}\text{C} \pm 5\text{ }^{\circ}\text{C}$  and  $30\% \pm 10\%$  RH. (Figure 13). Thermocouples installed on the paver surface allowed constant monitoring of the surface temperatures while six comparators mounted in a grid-pattern allowed measurement of movement. If the warping is due to a temperature and humidity gradient in the paver, this test should accelerate the phenomenon allowing estimation of the rate of warping.

The test pavers were new and not warped at reception, but after 200 days exposure are clearly warping. Figure 14 graphs illustrate the progression of warping with time for the two test pavers. Each data point is an average for the two comparators on the same relative position, i.e., left edge, center or right edge. Therefore, a high humidity under the paver due to the water drainage and the dry conditions on the top (wind and sun) can result in warping of the paver.

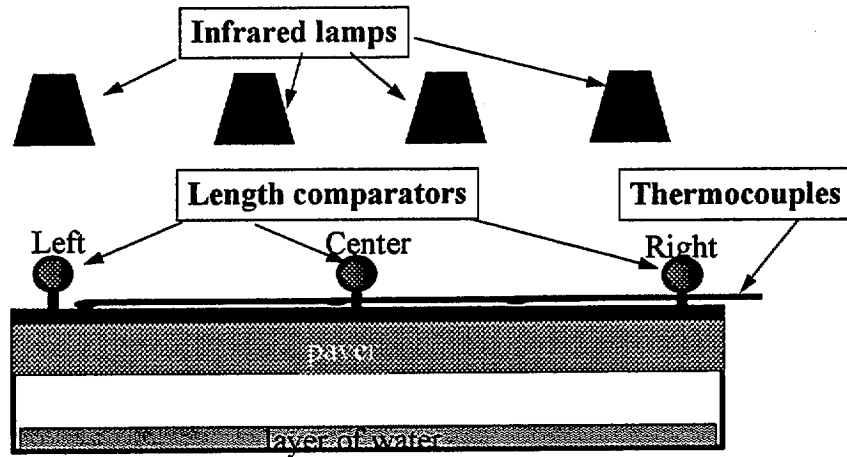

**Elevation**

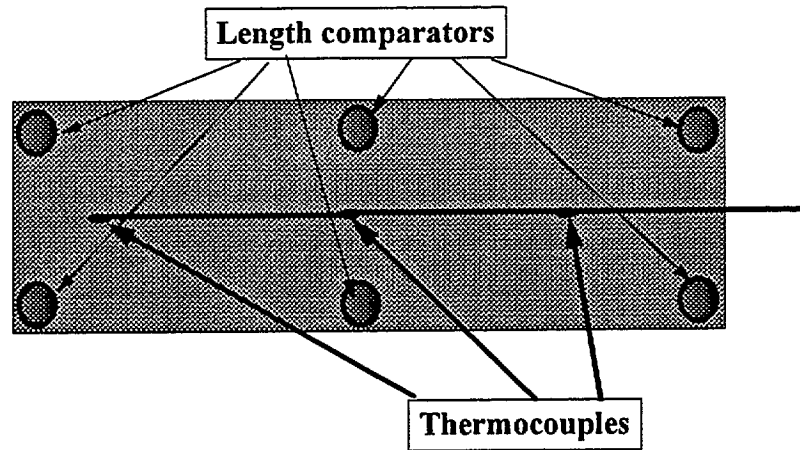

**Plan view**

**Figure 13: Experimental configuration for measuring deformation of a new paver**

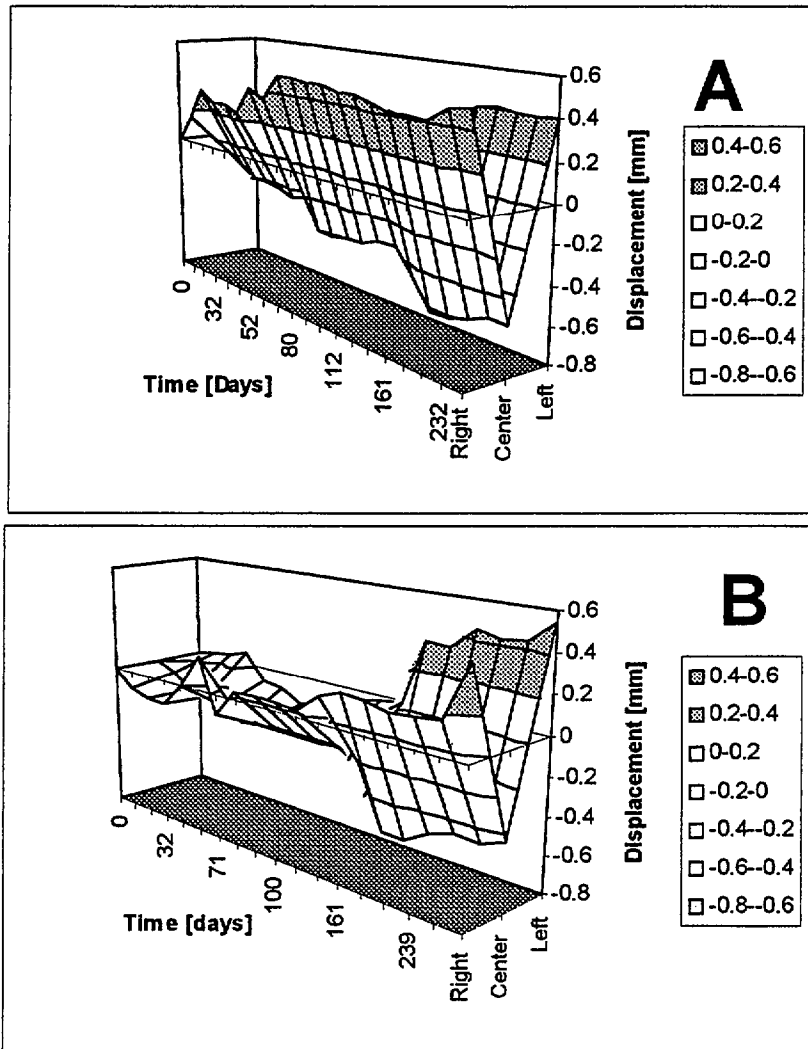

Figure 14: Paver warping vs. time. A and B denote two different pavers.

## 5. Summary and Conclusion

After a field inspection and laboratory tests, we can conclude that the two materials that were used to produce the two layers of the pavers are different in their behavior.

1. Drying shrinkage and swelling by water immersion: The substrate exhibited greater swelling and shrinking than the overlay,
2. Water absorption by capillary and water absorption capacity: Overall no major difference was noted on the sorptivity coefficient between the two materials comparable to conventional concrete. From the water absorption capacity test, it was inferred that the substrate is more porous than the overlay and that the new pavers are less porous than those in-service. This reflects degradation of the pavers, with micro-crack formation increasing the water absorption capacity.

3. Thermal expansion: The substrate has a higher coefficient of thermal expansion than the overlay when the pavers are water saturated. But due to the large scatter of the data, due to the inhomogeneity of the samples, this conclusion should be considered with caution.
4. Whole pavers testing to simulate field conditions: Two new pavers warped after 50 days of laboratory testing. The conditions were that the substrate was exposed to 100 % RH (standing water) while the overlay was exposed to  $45\text{ }^{\circ}\text{C} \pm 3\text{ }^{\circ}\text{C}$ .
5. Compressive and flexural strength: No difference between the two materials was measured, neither between the new and in-service pavers. They also were on specification.
6. ASR expansion: while little ASR reaction was observed in the in-service pavers, a potential exists, based on aggregate type observation and on testing by the modified ASTM C 1260.

In conclusion, petrographic examination found the paver microstructure to be dense, apparently of low water/cement proportioning, containing little air, and a very good bond between the upper white cement layer and concrete substrate. Both layers had a high cement content. Little indication of alkali-silica reaction was observed, and only on the substrate. Laboratory experiments showed a potential for warping due to differential length changes (due to water absorption) of the two layers used in the pavers. The warping may be exacerbated by the different environmental exposure conditions found at the top and base of the paver (higher humidity on the bottom than on the top).

The edge of concrete slabs curl upward when the bottom portion of the slabs has expanded more than the upper portion, or conversely, the top portion has shrunk more than the bottom portion. Because the substrate is likely to be at a nearly constant level of saturation and have a higher moisture content than the overlay, the overlay should shrink (or expand) less relative to the substrate. If the lower course is undergoing any expansion due to alkali-silica reaction, this expansion would contribute to the overall curling. However, it does not appear that alkali-silica reaction is a significant factor in the warping.

## **6. Acknowledgments**

This work was commissioned by the Office of the Architect of the Capitol. The authors would like to thank Mr. Krapp for providing all the specimens and the information needed, and John Winpigler and Frank Davis for preparing the specimens and performing the needed measurements.

## **7. References**

- 1 R.F. Ytterberg, "Shrinkage and Curling of Slabs on Grade, Part 2" Concrete International Design and Construction, May 1987.



- 2 ACI 209R-82, "Prediction of Creep, Shrinkage, and Temperature Effects in Concrete Structures," ACI Manual of Concrete Practice 1992, American Concrete Institute, Detroit, Michigan.
- 3 D.F. Orchard, Concrete Technology, Volume 1, 4<sup>th</sup> edition, Applied Science Publisher, London, 1979.
- 4 R.F. Ytterberg, "Shrinkage and Curling of Slabs on Grade, Part 1" Concrete International Design and Construction, April 1987.
- 5 H. W. Reinhardt, M. Sosoro and M. Aufrecht, "Development of HPC in Germany with Special Emphasis on Transport Phenomena", International Workshop on High Performance Concrete, Bangkok, Thailand, Ed. Paul Zia, ACI SP-159, 1994
- 6 N. Martys, C. Ferraris, "Water Sorption in Mortars and Concrete", submitted to Cem. Concr. Research 1996
- 7 Standard Test Method for Compressive Strength of Hydraulic Cement Mortars (using 2-in. or 50-mm Cube Specimens), ASTM designation C109-93, 1994 Annual book of ASTM Standards Vol. 04.01
- 8 Standard Test Method for Flexural Strength of Concrete (using a Simple Beam with Center-Point loading), ASTM designation C 293-94, 1995 Annual book of ASTM Standards Vol. 04.02
- 9 ACI Committee 302, "Guide for Concrete Floor and Slab Construction", ACI-302.1 R-80) American Concrete Institute, Detroit 1980
- 10 Standard Test Method for Potential Alkali-Reactivity of Cement-Aggregate Combinations (Mortar-bar Method), ASTM designation C 227-90, 1995 Annual book of ASTM Standards Vol. 04.02
- 11 Standard Test Method for Potential Alkali-Reactivity of Cement-Aggregate Combinations (Mortar-bar Method), ASTM designation C 1260-94, 1995 Annual book of ASTM Standards Vol. 04.02
- 12 Standard Specification for Wire Cloth and Sieves for Testing Purposes, ASTM designation E 11-95, 1995 Annual book of ASTM Standards Vol. 04.02
- 13 Standard Specification for Concrete Aggregates, ASTM designation C 33-93, 1995 Annual book of ASTM Standards Vol. 04.02

## Appendix I



Washington, DC 20515

August 21, 1995

Building Materials Division  
National Institute for Standards & Technology  
Gaithersburg, Maryland 20899

Attention: Dr. James R. Clifton

Gentlemen:

Re: **TERRACE REPAIRS AND RESTORATION**  
**UNITED STATES CAPITOL BUILDING**  
Purchase Order No. 956850  
Investigative Testing of Concrete Pavers

This will confirm that members of your staff picked up ten (10) concrete pavers from the Terraces for testing on August 8, 1995. The five (5) pavers marked with orange paint on the side were randomly selected from our spare stock of pavers. Five (5) pavers were removed from various areas of the Terrace as follows:

- Paver #1. This paver was removed from the lower level of the Terrace, North side, in the vicinity of Pier #4, second full row of pavers, the paver immediately south of the paver with the drain marker.
- Paver #2 This paver was removed from the lower level of the Terrace, North side, in the vicinity of Pier #6, second full row of pavers, the paver immediately south of the paver with the drain marker.
- Paver #3 This paver was removed from the lower level of the Terrace, Northwest side, in the vicinity of Pier #25, second full row of pavers, the paver two is (2) pavers south of the paver with the drain marker.
- Paver #4 This paver was removed from the lower level of the Terrace, West center, in the vicinity of Pier #42, third full row of pavers, the paver immediately north of the paver with the drain marker.

Investigative Testing of Concrete Pavers

August 21, 1995

Page 2

Paver #5      This paver was removed from the lower level of the Terrace, Southwest corner, in the vicinity of Pier #79, sixth full row of pavers, the paver in line with the centerline of the pier.

Please contact this office if you have any questions on the above. As discussed between you and Mr. Krapp of my staff, the testing program should be completed as soon as practicable. Informal, intermediate reports on the progress of the testing would be helpful.

Sincerely,

A handwritten signature in black ink, appearing to read "W.B. Holmes". The signature is written in a cursive, flowing style.

William B. Holmes, P.E.  
Superintendent of Construction

