



A11103 475864

NIST
PUBLICATIONS

NISTIR 4420

3D PIPING IGES APPLICATION PROTOCOL VERSION 1.0

**Mark E. Palmer
Kent A. Reed**

**U.S. DEPARTMENT OF COMMERCE
National Institute of Standards
and Technology
Center for Building Technology
Gaithersburg, MD 20899**

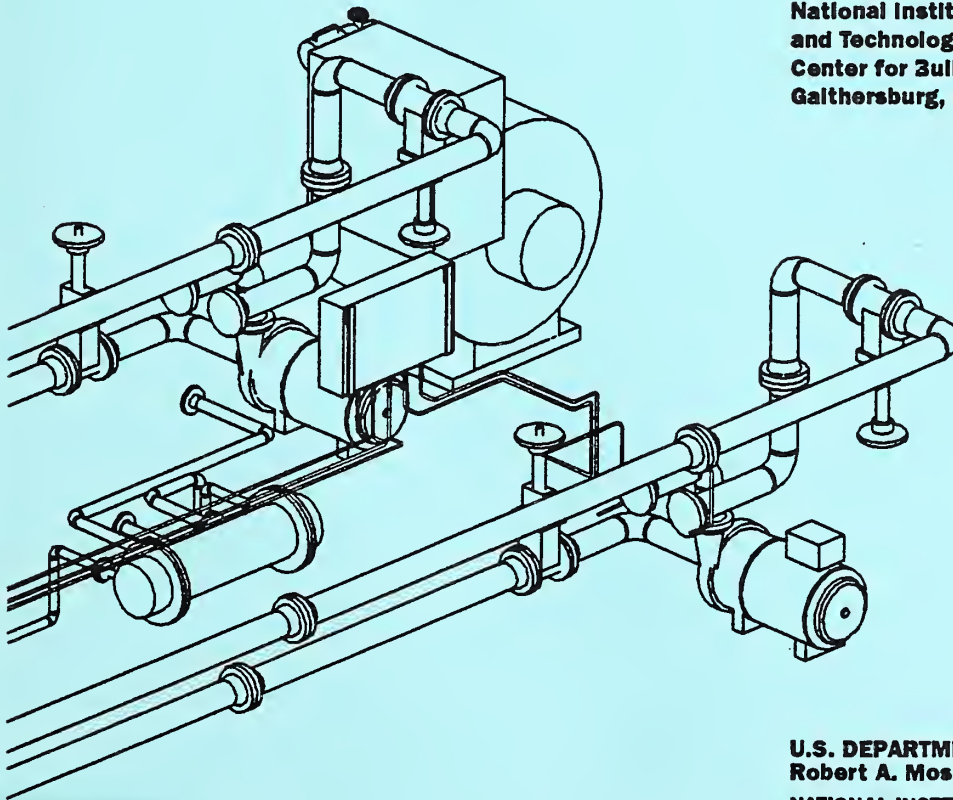

**U.S. DEPARTMENT OF COMMERCE
Robert A. Mosbacher, Secretary
NATIONAL INSTITUTE OF STANDARDS
AND TECHNOLOGY
John W. Lyons, Director**

QC
100
.U56
#4420
1990
C.2

NIST

NATIONAL INSTITUTE OF STANDARDS &
TECHNOLOGY
Research Information Center
Gaithersburg, MD 20899

3D PIPING IGES APPLICATION PROTOCOL VERSION 1.0

**Mark E. Palmer
Kent A. Reed**

**U.S. DEPARTMENT OF COMMERCE
National Institute of Standards
and Technology
Center for Building Technology
Gaithersburg, MD 20899**

September 1990



**U.S. DEPARTMENT OF COMMERCE
Robert A. Mosbacher, Secretary
NATIONAL INSTITUTE OF STANDARDS
AND TECHNOLOGY
John W. Lyons, Director**

ABSTRACT

The 3D Piping IGES Application Protocol (AP) specifies the mechanisms for defining and exchanging 3D piping system models in IGES format. The AP defines three-dimensional arrangement data of piping systems which includes definition data types of geometry (shape and location), connectivity, and material characteristics. The scope of this AP includes only piping system data and not drawings or internal details of equipment. The specified piping model is sufficiently detailed to support the fabrication and final assembly of a piping system.

IGES is designed to support a broad range of applications and information, and it is recognized that few implementations will support all of the specification. An application protocol defines a logical subschema of the IGES specification, the usage of the subschema, and the necessary benchmarks for testing implementations. The 3D Piping IGES Application Protocol is the first IGES AP to be delivered to industry and is an important example for the development of STEP (Standard for the Exchange of Product Model Data) application protocols.

PREFACE

The representations outlined in this document were initially developed under the U.S. Navy's SEAWOLF program¹ by a joint effort of NAVSEA, Newport News Shipbuilding, and General Dynamics / Electric Boat Division. This material has been reviewed and enhanced by representatives of the process plant industry to develop a specification which meets the requirements of a broad user community of 3D piping applications.

This document does not represent a final solution for the efficient exchange of complete 3D piping system models. This application protocol (AP) only supports the definition of a part to be instanced many times. This version of the AP does not provide full catalog functionality. A parallel project has been initiated to develop the catalog functionality. When this catalog work is complete, it will be submitted as an extension for this AP.

This AP will be further tested and refined in developing a revision for MIL-D-28000A². This revision will define a new class for the transfer of 3D Piping Models by use of IGES Version 5.0.

Comments on this document should be sent to the project leader:

Mark Palmer
Center for Building Technology
National Institute of Standards and Technology
Building 226 Room B306
Gaithersburg, MD 20899
(301) 975-5858

¹ SEAWOLF is a major program under the Department of Defense (DoD) Computer-aided Acquisition and Logistic Support (CALs) Program. CALs is a DoD and industry strategy to enable, and to accelerate, the integration of digital technical information for weapon system acquisition, design, manufacture, and support.

² MIL-D-28000A is the DoD specification that identifies the requirements to be met when product definition data is delivered in IGES format.

ACKNOWLEDGMENT

The following individuals contributed to the development of this document:

Steve Arnold	A. Epstein and Sons, Int.
Larry Benthall	Brown & Root, Inc.
Bruce Calkins	NAVSEA/SEACOSD
Gus Cinardo	General Foods
Bill Danner	NIST/CBT
Julian Fowler	CADDETC
Leland Frayseth	Bechtel Petroleum
Burton Gischner	General Dynamics / Electric Boat
Joe Halford	Du Pont
Ernie Heimberg	Prime Computer, Inc.
Bill House	Bechtel Power
Bob Jones	Intergraph Corp.
Pete Lazo	Newport News Shipbuilding
Doug Martin	National Steel & Shipbuilding Co.
Greg Morea	General Dynamics / Electric Boat
Jim Murphy	NAVSEA/NIDDESC
Mark Palmer	NIST/CBT
Denis Payne	CADCentre Ltd.
Kent Reed	NIST/CBT
Chris Schwander	Du Pont
Gladys Scott	Newport News Shipbuilding
Dan Wooley	Newport News Shipbuilding

TABLE OF CONTENTS

Abstract	iii
Preface	v
1. Introduction	1-1
1.1 Purpose	1-1
1.2 Background	1-1
1.3 IGES Application Protocol Definitions	1-1
2. Fundamental Concepts	2-1
2.1 Development and Use of Application Information Models	2-1
2.2 IGES Application Protocol Validation	2-2
3. 3D Piping Application Information Requirements and Application Reference Model	3-1
3.1 Piping Application	3-1
3.2 Scope	3-1
3.3 Application Core Requirements	3-4
3.4 Piping Definitions	3-9
3.5 Application Reference Model	3-15
4. 3D Piping IGES Application Interpreted Model	4-1
4.1 IGES File Structure	4-1
4.1.1 Start Section	4-2
4.1.2 Global Section	4-2
4.1.3 Directory Entry Section	4-3
4.1.4 Parameter Data Section	4-3
4.2 Piping IGES Constructs	4-5
4.2.1 Piping System	4-5
4.2.2 Pipe Run	4-10
4.2.3 Piping Assembly	4-15
4.2.4 Piping Port	4-21
4.2.5 Object Envelope	4-29
4.2.6 Pipe	4-45
4.2.7 Unmodified Piping Component	4-55
4.2.8 Modified Piping Component	4-62
4.2.9 Piping Component Definition	4-71

4.2.10	Unmodified Piping Equipment	4-76
4.2.11	Modified Piping Equipment	4-83
4.2.12	Piping Equipment Definition	4-87
4.2.13	Piping Support	4-91
4.2.14	Piping Support Definition	4-99
4.2.15	Pipe Damping	4-105
4.2.16	Piping Joint	4-112
4.2.17	Pipe Damping Attachment	4-126
4.2.18	Piping Support Attachment	4-132
4.2.19	Piping Insulation	4-138
5.	Implementation and Conformance Testing Guidelines	5-1
5.1	Processor Conformance Requirements	5-1
5.2	Development and Use of an IGES Application Protocol Abstract Test Suite	5-2
5.3	3D Piping IGES Application Protocol Test Groups and Test Purposes	5-3
6.	References	6-1
Appendices		
A.	Activity Model for Piping System Design	A-1
B.	Piping System Example	B-1
C.	Guide to Reading NIAM Diagrams	C-1
D.	3D Piping IGES AIM	D-1
E.	Guide to Reading IGES AIM Diagrams	E-1

1. INTRODUCTION

1.1 Purpose

This piping application protocol (AP) uses the Initial Graphics Exchange Specification (IGES) Version 5.0 [1] for the representation of three-dimensional (3D) piping and related equipment models and the exchange of these models from one piping modeling application to another. Since the piping application protocol makes use of a specific interpretation of entities in the IGES file, both the sending and receiving sites **must** support the 3D piping system application, not just the IGES entities listed.

This AP is for exchanging 3D arrangement data of piping system models which includes definition data types of geometry (shape and location), connectivity, and material characteristics. The scope of this AP includes only piping system data and not drawings, internal details of equipment, or interference check results. The AP does support the information required for performing interference analysis. The specified piping model is sufficiently detailed to support the fabrication and final assembly of a piping system.

1.2 Background

Industry requires comprehensive and reliable data exchange mechanisms to effectively integrate CAD (computer-aided design) technology. IGES is designed to support a broad range of applications and information, and it is recognized that few implementations will support all of the specification. Additionally, implementations of IGES translators for different CAD systems continue to be uneven in quality and capability. An application protocol defines a logical subschema of the IGES specification, the usage of the subschema, and the necessary benchmarks for testing implementations.

The representations discussed in this document were initially developed under the U.S. Navy's SEA WOLF program for exchanging data from the detail design phase to pipe fabrication and assembly. This material has been reviewed and enhanced by representatives of the process plant industry to develop a specification which meets the requirements of a broad user community of 3D piping applications.

Although the AP allows for the use of reference files for the definition of piping parts, this version of the AP does not provide full catalog functionality. A parallel project has been initiated to develop the catalog functionality. When this catalog work is complete, it will be submitted to the Architecture, Engineering, and Construction (AEC) Committee of the IGES/PDES Organization as a proposed extension for this AP.

1.3 IGES Application Protocol Definitions [2]

Application: An enterprise process that puts product data to use. The scope of an application is defined by the class of product, the supported stages in the life cycle of the product, the uses of the product data, and the disciplines that participate in that use.

Application Interpreted Model (AIM) - An information model that describes the logical information structures required for accomplishing a physical implementation of an associated application reference model. The AIM is prepared at a level of abstraction that is sufficient for selecting the necessary IGES entities for an application protocol.

Application Protocol (AP): Defines the scope and information domain of an application and specifies the rules for using IGES, or some other standard, to enable the transfer of the application information.

Application Reference Model (ARM) - An information model that describes the information structures and constraints for an application area. The information model uses application specific terminology and rules familiar to an expert from the application area. The model is independent of any physical implementation and can be validated by an expert from the application area.

Application Subset - An unambiguous set of IGES entities which span the data requirements of the specified application. The set of IGES entities is determined on the basis of the Application Reference Model.

Entity - The basic unit of data in an IGES file. The term applies to single units which may be individual elements of geometry, individual elements of annotation, or collections of geometry or annotation elements that are combined to form more complex data structures.

IGES Postprocessor - A software unit that transfers CAD information from the IGES format to the CAD database format of a particular system. The software is usually developed and maintained by a commercial CAD system vendor.

IGES Preprocessor - A software unit that translates CAD information from the CAD database format of a particular CAD system to the IGES format. The software unit is usually developed and maintained by a commercial CAD system vendor.

Information Configuration Control - An approach that consists of specifying, documenting, and controlling both the creation and modification of information and the subsequent translation and exchange of the information between different systems and formats. The approach requires substantial documentation for both the syntax (the format) and the semantics (the meaning) attached to an item of information.

Product - A result produced by specified activities or used for specified activities.

Product Data - The set of data elements that is necessary to fully support a product over its expected life cycle. The set of data elements includes all of the product definition data plus other data pertaining to the operation and maintenance of the product until it is removed from service.

Product Definition Data - The set of data elements that completely define a product for a certain discipline; a subset of product data. This set of data elements includes the geometry, topology, features, tolerances, and relationships necessary to completely define a component part or an assembly of parts and is structured such that it can be used by one or more applications.

Semantics - The meaning that is given or assigned to an item of information. The meaning is assigned to an item of information on the basis of its application area.

Syntax - The structure of expressions in a language. [3] This structure is described in a specification such as IGES.

2. FUNDAMENTAL CONCEPTS

The successful use IGES for CAD information exchanges requires organizations to have comprehensive technical information management plans and documented procedures for creating, delivering, and maintaining technical information in digital form. This documentation must include the standardized modeling conventions by which product information is created and the protocol for precisely transferring that information via the IGES format.

A protocol is a set of conventions or rules that govern the operation of functional units to achieve communication. [3] IGES application protocols provide a formal procedure for specifying neutral, IGES-based, application specific formats. This procedure involves identifying the information requirements of an application area and documenting them in a conceptual information model. The conceptual information model is then used to select the IGES constructs for representing the required information.

The concept of application protocols incorporates many of the lessons learned from the use of IGES and some of the ideas from the current development of STEP (Standard for the Exchange of Product Model Data). IGES application protocols can be said to allow the exchange of information, while the use of IGES alone allows only the exchange of data.

An IGES AP defines the information content of a specific application area, specifies the mapping of the application information into IGES constructs, and describes the restrictions and conventions required in implementing these constructs. The five major elements of an application protocol are (1) a scope and requirements section, (2) an application reference model of the supported information (3) an application interpreted model that shows how the information is mapped into a specification such as IGES or STEP (Standard for the Exchange of Product Model Data), (4) an AP format specification with a usage guide, and (5) conformance requirements and test cases.

The exchange of information using an IGES AP requires that the participating organizations agree to the types of information to be exchanged and that they employ corresponding information configuration control procedures. This provides the framework for the reliable use of a specific IGES AP.

2.1 Development and Use of Application Information Models

The first phase of developing an AP is to define the scope, context, and requirements of the application. With these specified, the information content, also referred to as the domain of discourse, can be described by the use of an Application Reference Model (ARM).

The ARM is an information model that documents the information structures of the subject application, and provides the baseline from which candidate interpreted models are developed. For an IGES AP, the ARM is then used to develop the corresponding IGES Application Interpreted Model (AIM). The AIM shows how the information content from the ARM is to be expressed by a subset of IGES entities.

The IGES entities selected for use in the AP format specification should be selected to minimize the size of AP format files. The options for the use of the entities within this subset must be restricted so that only one method is available for carrying each element of information from the ARM. The set of IGES entities and the necessary restrictions on the Global, Directory Entry, and Parameter Data Section field values are developed by using the ARM and the AIM.

The conformance requirements and test purposes for the AP must also be developed. The conformance requirements must correspond with the application requirements. The suite of test purposes must cover the information content of the ARM and the constructs of the AIM. Each test purpose is used to specify abstract test cases for testing both pre- and postprocessors. An abstract test case is self-contained and provides the information necessary to construct an executable test case.

2.2 IGES Application Protocol Validation

A summary of the model validation procedures for proposed APs is given below in one sentence statements, followed by a more detailed description of the complete methodology:

1. ARM validation evaluates the completeness and correctness of the ARM's representation of the information requirements for the application area.
2. AIM validation evaluates the completeness and correctness of the AIM's representation of the AP information requirements as specified by the ARM.
3. Conformance requirements and test purposes evaluation analyzes the completeness of coverage, correctness, and self-consistency of these components with the ARM and AIM.

Part 1, ARM validation, uses a team of experts from the subject application area to provide peer reviews of the ARM. Sample instances (test pieces) of the concepts that the AP is intended to support are used to validate the ARM. This stage ensures that the ARM satisfies the stated scope of the AP and that the ARM is self-consistent.

For an optimum model validation of the ARM, the reviewers must not be the same experts that participated in the development of the information model. This part of the process will be manpower intensive. Due to the current state of information modeling software tools, it is not possible to simply use a computer program to evaluate the ARM for completeness or correctness.

The success criteria for this model validation is that the ARM accurately captures all of the information requirements for the application scope. The evaluation must be done in an incremental way such that each expert will study and evaluate a section of the information model and produce an evaluation report on that section of the model. When this step in the model validation process is passed, a summary report is produced to describe the successful ARM validation.

Part 2, AIM validation, involves the evaluation of the AIM and the AP format for the ability to carry all of the information requirements specified by the AP requirements and ARM. This model validation must check that all items of information defined in the ARM can be expressed in the AP format as specified by the AIM and the usage guide. The objective is to ensure semantic correspondence between the ARM and the AIM. This part of the AP model validation will require both application area experts and experts in the capabilities and use of IGES.

Part 3, conformance requirements and test purposes evaluation, analyzes the completeness of coverage, correctness, and self-consistency of the test purposes with the ARM and AIM. The test purposes must exercise all possible paths from the ARM to the AIM, e.g., all possible AP information structures, and not all possible combinations of AP information structures.

The development and validation of an IGES AP is an incremental and iterative process of progressive detail. Each step in this process provides critical feedback for the next version of the AP.

3. APPLICATION INFORMATION REQUIREMENTS AND REFERENCE MODEL

3.1 Piping Application

Piping systems are used to convey and process fluids and gases in a variety of industries, including: chemical and petrochemical processing, power generation, ship and aircraft construction, and food processing. Generally, a piping system is comprised of a network of pipe, pipe fittings, and processing equipment such as pressure vessels and pumps. Large piping systems are generally attached to some supporting structure through the use of pipe supports and hangers. Insulation, heat tracing, and vibration or sound damping assemblies are often attached to piping systems.

Many software packages are now available to assist the design and manipulation of 3D models of piping systems. The model contains information about each element of the system as well as that of the system as a whole. It may also contain information about groups of elements within a piping system. The 3D model generally serves as a source of input for numerous activities related to the design, fabrication, and assembly of piping systems.

3.2 Scope

The scope of this application protocol is the exchange of 3D piping models. For this application protocol, a 3D piping model consists only of piping system data. Specifically excluded are other types of systems that are similarly modeled, i.e., structural steel and concrete, HVAC (heating, ventilating and air-conditioning), and electrical cable tray and conduit systems.

This AP is defined with a core of required data which supports a corresponding set of required piping-related activities. These activities are shown on Figure 3-1 and are defined in detail in the following section. The functionality of the core data can be extended with sender/receiver defined data elements. Figure 3-1 shows all activities that are explicitly supported by this protocol.

A group of extended data sets are planned for future versions of this AP. These extended data sets will support additional piping-related activities that require details beyond those provided by the core. Extended data sets are further subdivided into three classes: 1) sender/receiver defined data, 2) extended project data, and 3) extended application data. This architecture is depicted in Figure 3-2.

Physical objects that are represented in 3D piping models, and that are defined to reside within the core region of this protocol, are:

- 1) Pipe - Piping, tubing, or hose, either variable or fixed length.

Note: It is recognized that the pipe path of tubing and hose is not static. However, within this AP, the pipe path of tubing and hose is defined at an approximate static location.

- 2) Piping Components

- A) Commodities - Standard fittings purchasable off the shelf (e.g., elbows, reducers, tees, valves).

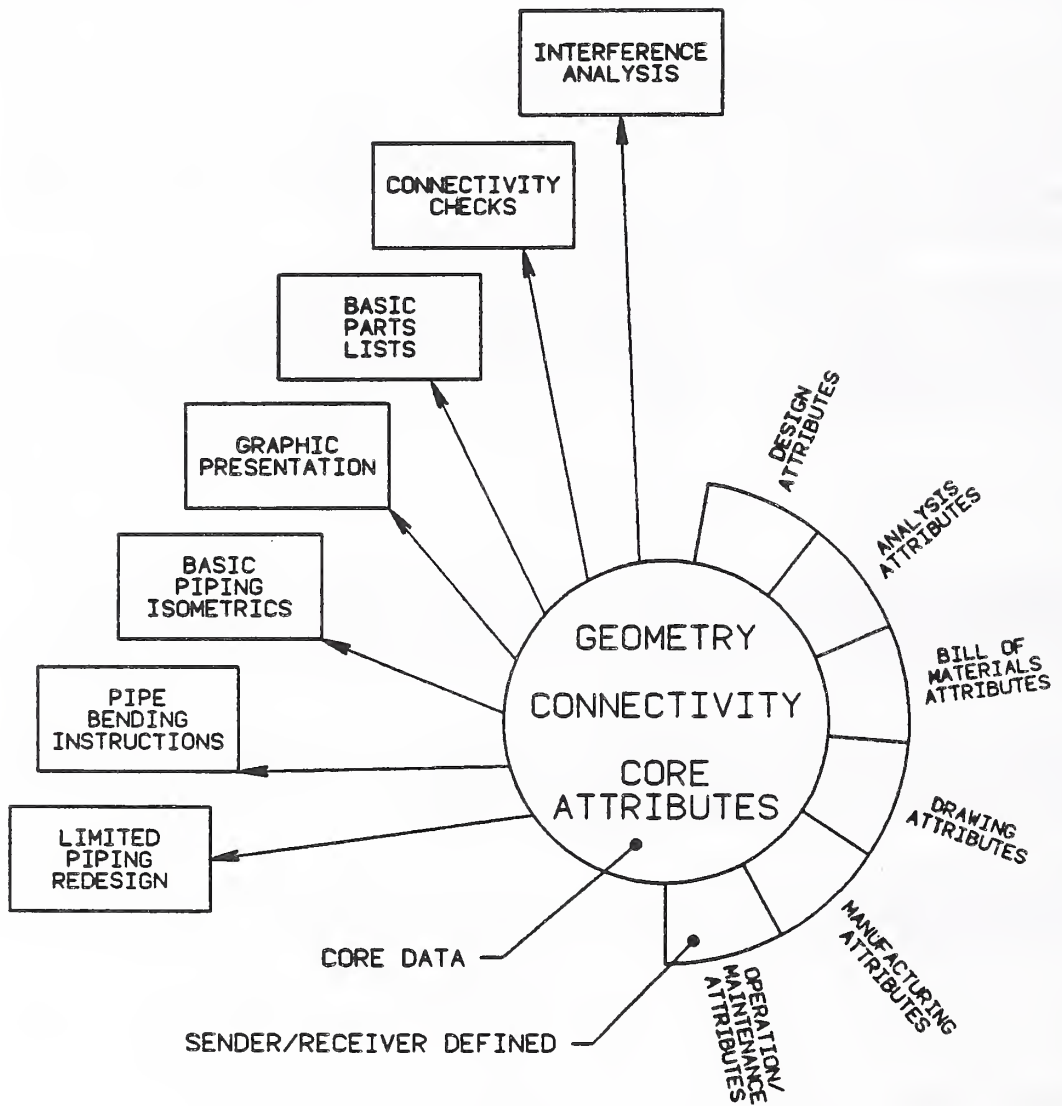

FIGURE 3-1: 3D PIPING IGES APPLICATION PROTOCOL SCOPE

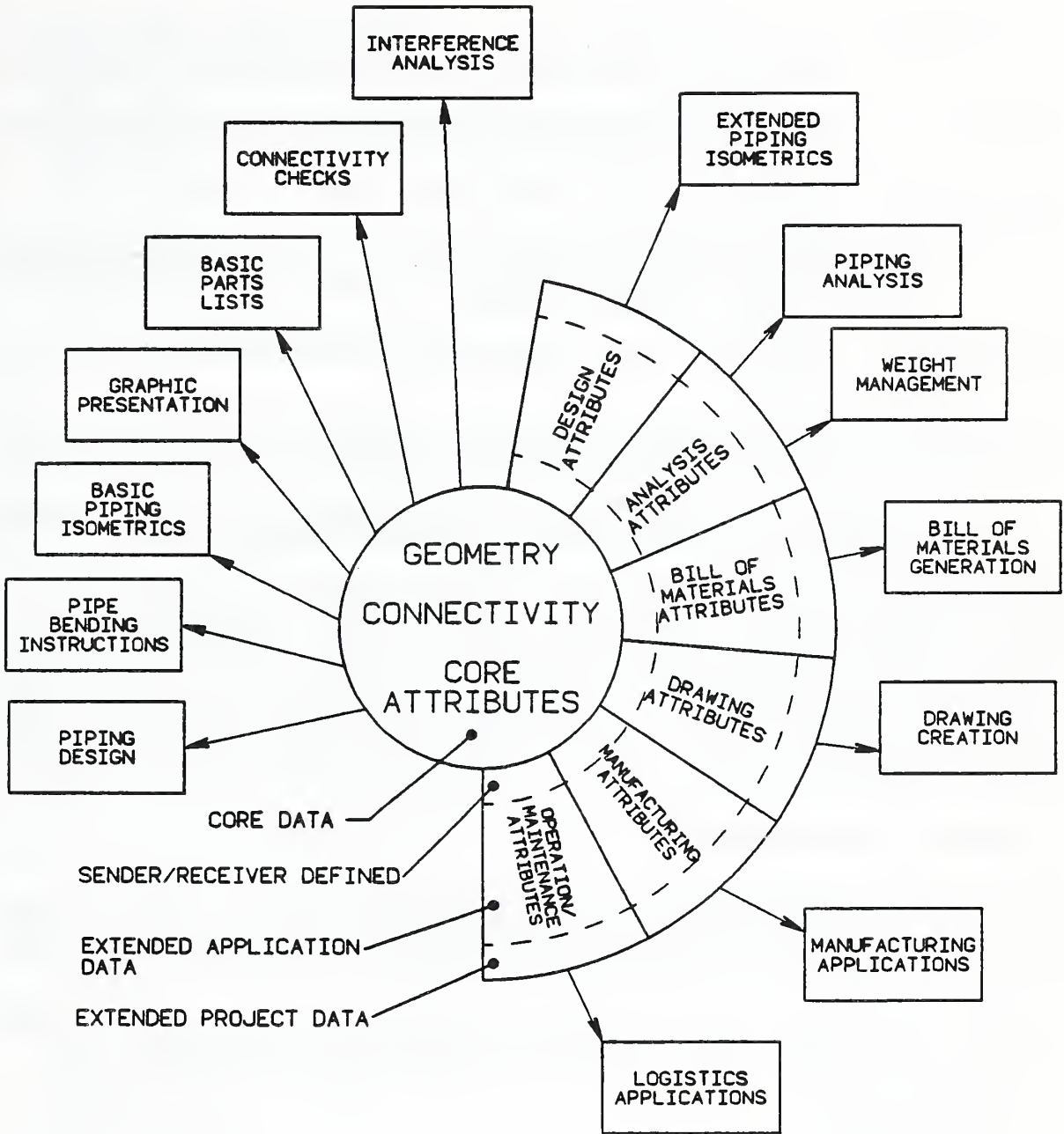

FIGURE 3-2: PLANNED EXTENSIONS TO THE SCOPE OF THE 3D PIPING IGES APPLICATION PROTOCOL

B) Specialties - Non-standard fittings used for process control (e.g., control valves, relief valves, gauges) or other special functions (e.g. filters, expansion joints, steam traps.)

3) Fasteners - Bolts, gaskets, welds, clamps, etc. that may be needed to join piping components or pipe to other piping components, pipes, or piping equipment nozzles.

4) Piping Supports - Items used to anchor or restrain piping systems.

Note: The scope of this application protocol does not extend to the full detailing of pipe support systems. Excluded in particular are full details of structural steel members that may comprise pipe support assemblies.

5) Pipe Damping - Items attached to piping systems to protect them from damage due to vibration or shock.

6) Piping Equipment - Pressure vessels, rotating equipment, furnaces, etc. to which piping systems are normally connected via nozzles.

Note: The scope of this application protocol does not extend to the full detailing of equipment items from either a process function or mechanical design point of view.

This AP also supports the grouping of physical objects into structures such as pipe runs, piping assemblies, and piping systems. A pipe run is a single path through a portion of a piping system having a common specification, common attribute values, and having one start and one end point. A piping assembly is a collection of piping parts and/or other piping assemblies for the purpose of construction (e.g., shop spool pieces and packaged systems). A piping system is a collection of one or many pipe runs and zero, one, or many pieces of equipment that performs a specific design function. A piping system, as defined in this AP, is equivalent to one or more 'pipelines', a term which is often used in the process plant industry.

3.3 Application Core Requirements

The data transferred using this application protocol must include descriptions of all pipes, components, equipment, pipe supports, and pipe damping with sufficient detail to support the following applications on a receiving system:

1. Interference analysis (e.g., 3D solid): A check for spacial conflicts or overlaps between the elements of the 3-D piping model. Objects which may be considered in the analysis include:
 - pipe
 - piping components
 - piping equipment
 - access envelopes,
 - insulation envelopes, and
 - other envelopes from another source (e.g., non-piping equipment, structural members, ship hull)

Required data:

- piping system network topology
- piping parts' locations and orientations
- pipe path and nominal pipe size

- piping component object envelope(s)
- piping equipment object envelope(s)
- piping support object envelope
- pipe damping shape
- piping joints
- identification attributes (object identifier)
- project area
- pipe run attributes, including:
 - pipe run name
 - insulation thickness
 - extent of insulation
- identification attributes, including:
 - part names
 - stock number (commodity code) or tag number

Where,

- 1) Piping system network topology are the data structures within a 3D model which define how the elements of the model are connected to one another.
2. Connectivity check: A check on the validity of the piping system network. The following network characteristics can be verified:
 - positional consistency
 - alignment checking
 - end type compatibility

Where,

- 1) Positional consistency checks verify that there are no gaps or overlaps between the elements of the 3D model which should be "connected."
- 2) Alignment checking ensures that elements of the model are oriented properly with respect to those to which they are connected.
- 3) End type compatibility checking ensures that the attachments between connected elements of the model are physically possible (e.g. flanges must be attached only to other flanges of the same nominal diameter and having the same bolt hole pattern).

Required Data:

- piping system network topology
- piping part locations and orientations
- piping port attributes, including:
 - nominal pipe size
 - end preparation type
 - schedule/thickness
 - pressure rating
- piping port location and orientation
- pipe run attributes, including:
 - pipe run name

Where,

- 1) Piping ports represent attachment points on pipe, piping components, and piping equipment elements.
 - 2) Piping port location defines the position of an attachment point in space. The orientation defines the orientation of the flow centerline of the attachment point.
3. Basic parts lists: Produce a listing of the elements comprising the 3D piping model.

Required data:

- pipe run attributes, including:
 - pipe run name
 - pipe specification name
- pipe, piping component, and fastener attributes, including:
 - part name
 - stock number or tag number
 - bolt type, length, and diameter (bolts only)
- piping port attributes, including:
 - nominal pipe size
 - end preparation type
 - schedule/thickness
- piping equipment attributes, including:
 - stock number or tag number
- piping support attributes, including:
 - part name
 - stock number or tag number
- pipe damping attributes, including:
 - stock number or tag number
- piping assembly identifier

4. Graphic presentation: Produce shaded and wireframe images of the 3D piping model on a display screen or hardcopy device using viewing and clipping information added on the receiving system. Although this AP does not provide the capability to exchange drawings, the piping model provided through this AP supports the development of drawings on the receiving system.

Required data:

- piping system network topology
- piping part location and orientation
- piping component object envelope(s)
- piping equipment object envelope(s)
- piping support object envelope
- pipe damping shape
- insulation thickness
- insulation start and end

5. Basic piping isometrics: Generation of isometric drawings from the 3D model.

Required data:

- piping system network topology
- piping part location and orientation
- pipe run
- pipe path and nominal pipe size
- piping component object envelope(s)

- piping equipment object envelope(s)
- piping support object envelope(s)
- piping joint identifier
- piping port data (end preparation, pressure rating)
- flow direction
- fastener data (length, size, quantity)
- insulation thickness
- insulation start and end
- material name
- stock number or tag number
- shop / field material status (shop = used for fabrication in a shop, field = used for assembly at a site)
- tracing requirements
- stock number or tag number
- project area
- location of field weld

6. Generation of pipe bending instructions: Produce instructions for bending pipe on a pipe bending machine using bending machine tables and bending rules on the receiving system.

Required data:

- pipe path (from which the pipe bend radii can be generated)
- nominal pipe size
- pipe wall thickness
- pipe material

7. Limited piping redesign: Provide the following limited redesign capabilities:

(a) Modification of the space arrangement by

- rotation and/or translation of pipes, piping components, piping equipment, piping supports, and pipe damping
- modification of the pipe path

(b) Modification of the construction sequence provided in the piping assembly.

Required data:

- pipe path
- piping component location and orientation
- piping equipment location and orientation
- piping support location and orientation
- pipe damping shape
- piping assembly

Other applications could be supported by this AP with additional data requirements. The current proposed extensions are listed below.

E1. Piping Design: In addition to the functionality specified in "limited piping redesign" of the core AP, piping design includes the following functionality:

- transfer and use of a piping specification
- transfer and use of a component reference catalog
- post-translation placements of transferred components

E2. Extended Piping Isometrics: In addition to the functionality specified in the "basic piping isometrics" of the core AP, extended piping isometrics includes the additional attributes necessary to support isometrics for fabrication and construction. This includes data such as:

- design & operating conditions (pressure and temperature)
- flow direction
- heat tracing media and temperature
- locations on the pipe line of field welds
- locations on the pipe line of isometric sheet breaks
- spool numbers
- painting requirements
- clean/testing requirements
- construction status
- title block information

E3. Piping analysis: The extraction of geometry and attribute data for input to stress analysis.

E4. Weight Management: The extraction of weight and center of gravity data.

E5. Bill of Material (BOM) Generation: Produce a list of items in the piping model, with sufficient descriptive information to purchase each item. BOM data should include:

- The stock number (or tag number), size, short description, and quantity of each item in a pipe run (including bolts and gaskets). The short description should include schedule/thickness, pressure rating, materials of construction, and references to details or standards as required to identify the items.
- Cut pipe summary, which accurately accounts for insertion depth at socket weld and threaded connections.
- Identification of items supplied by the shop, supplied by other sources, or provided in the field.

E6. Drawing Creation: Drawings are derived from a 3D model by assembling or composing one or more views of the model together with annotation, dimensioning, and graphics produced by hidden-line removal. Drawings may contain "intelligence" in the sense that if a change is made in the model, a corresponding change occurs in drawings that reference that affected volume of the model. Data structures that support the "intelligence" feature include: associative coordinate labels, associative annotation (i.e. text), and associative dimensioning.

E7. Manufacturing Applications: Provides additional attributes to support manufacturing of piping equipment and special piping components.

E8. Logistics Applications: Provides additional attributes to support the Operations and Maintenance portion of the life cycle. This includes data such as:

- customer's item identifier (that ties to other databases)
- valve percent open
- last inspection date
- leakage rate
- last maintenance date

3.4 Piping Definitions

Access Envelope Definition - A volume of space associated with a definition of a piping component or piping equipment that is used to reserve space for access or maintenance.

Added Piping Component Port - A type of piping port which is added to an unmodified piping component. This port locates where the piping component may join to a pipe, another piping component, or a piece of piping equipment. The additional piping component ports are not part of the piping component definition. They are used to represent field modification of a component.

Attribute - A single data that describes a specific characteristic of a piping entity.

Bolt - A type of fastener for flanged piping joints. The geometry of a bolt is not included in the piping model.

Bolt Type - An attribute of a bolt which identifies a unique set of bolt characteristics.

Brazed - A connection between two pipes or piping components where the joint is made by using brazing applied with heat. The end inserted into the socket is the male end, while the end containing the socket is the female end.

Butt Weld - A type of mating between two pipes or piping components where two parallel end faces are attached together by welding.

Definition Space Location - The three-dimensional position of a piping entity's origin relative to the definition space coordinate system.

Definition Space Orientation - The three-dimensional rotation of a piping entity's origin relative to the definition space coordinate system.

End Preparation - The physical configuration for a type of connection of a piping port. The primary types of connection for joining piping parts at ports are: butt weld, socket weld, brazed, flanged, threaded, flareless tube, and slip joint. Each type of connection supports one or more end preparations.

Fastener - An item used to affix two piping ports to make a completed piping joint. There are three types of fastener: bolt, gasket, and other (e.g., glue or sealing compound).

Flanged - A mechanical connection between two piping components where the flanged ends of each component are placed parallel to each other and attached by bolts.

Flareless Tube - A mechanical joint between two pipes or piping components where the connection is made by a ferrule inserted in a socket and attached by a mechanical coupling.

Gasket - A ring of material used to seal a flanged connection between piping parts. The geometry of a gasket is not included in the piping model.

Heat Tracing - A heating element used for controlling the temperature along a pipe or a pipe run.

Installed Access Envelope - An access envelope associated with an occurrence of a piping component or piping equipment. It is used when the access envelope of the component or equipment definition does not satisfy the access requirements at the occurrence level.

Insulation End - The location of the start or the end of piping insulation.

Insulation Shape Envelope Definition - The shape of a component or equipment definition entity to which insulation thickness is added to form an insulation envelope. The insulation shape envelope may be different than the piping object envelope. For example, it may contain less detail and would not include portions of the part that are not covered by insulation such as a hand wheel.

Insulation Specification - The source document that defines the allowable materials for a given process or insulation requirements.

Joint Fabrication Location - An attribute of a piping joint which identifies where a piping joint will be assembled (e.g., at the fabrication shop or at the construction site).

Material Description - An attribute of a piping part which describes the piping part for purchasing purposes. The material description is usually associated with a stock number and, depending upon company practices, may not contain size information.

Material Name - An attribute of a piping part which describes the primary material from which the piping part is manufactured.

Model Space Location - The three-dimensional position of a piping entity's origin relative to the model space coordinate system.

Model Space Orientation - The three-dimensional rotation of a piping entity's origin relative to the model space coordinate system.

Modified Piping Component - A type of piping component that has zero, one, or many added piping component ports and may have zero or one installed access envelope. A modified piping component must have at least one of these two objects added to an unmodified piping component.

Modified Piping Equipment - A type of piping equipment that has one and only one installed access envelope added to an unmodified piping equipment.

Nominal Pipe Size - An attribute of a pipe which describes the size of the pipe bore for specification purposes, but does not describes the true bore (i.e. internal diameter) or outside diameter.

Nominal Pipe Size Type - An attribute of a pipe which identifies the nominal pipe size as inside diameter or outside diameter.

Object Envelope Definition - A volume of space that is reserved with the definition of a piping part.

Part Class - An attribute of a piping entity which identifies a unique set of characteristics of the entity. Part Class is the "type" of piping entity, e.g., elbow, tee, pipe, reducer, etc.

Pipe - A hollow cylindrical conveyance, with a constant radius for the cross-sectional circle, for directing fluid or gas flow. It is not restricted to any length, diameter, or wall thickness. A pipe may be metallic or plastic and semi-rigid in nature.

Pipe Branch Port - A type of piping port, located along a pipe centerline, that locates where a component or another pipe may be joined via a piping joint (refer to Figure 3-3).

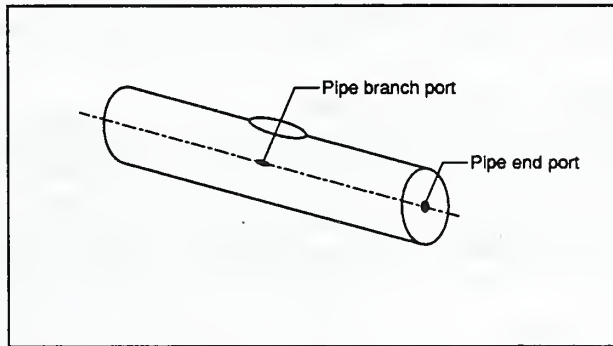

Figure 3-3: Pipe Branch Port

Pipe Damping - Material added to a section of pipe for the purpose of reducing vibration or noise. Damping material commonly used are metallic strips with a tape underlay that are banded to the outside wall of a pipe parallel to the pipe centerline (refer to Figure 3-4). Pipe damping does not provide support.

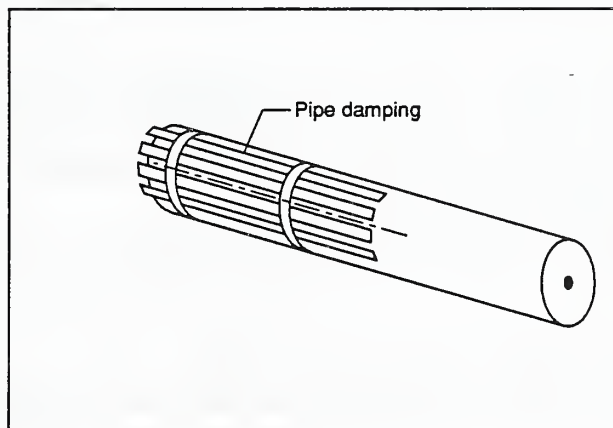

Figure 3-4: Pipe Damping

Pipe Damping Attachment - A logical entity which connects a pipe damping to a piping part.

Pipe Damping Definition - A standard set of attributes used for representing a type of pipe damping.

Pipe Damping Segment - The geometric representation of the pipe damping length.

Pipe Definition - A set of attributes that define raw pipe stock.

Pipe End Port - A type of piping port located at the start or end of a pipe that locates where a component, a piece of equipment or another pipe may be joined via a piping joint.

Pipe Fit Up Length - Extra material added at the port of a piping part to support assembly requirements.

Pipe Outside Diameter - The actual outside diameter of a pipe.

Pipe Path - A curve consisting of one or more lines and circular arcs that represents the centerline of a pipe.

Pipe Run - A single path through a portion of a piping system having a common specification, common attribute values, and having one start and one end point. It is represented by a string of connected pipes and components originating and terminating at a component with more than two ports, at a change in pipe run attributes, or at a boundary point in the piping system. A pipe run may originate, terminate, or pass through a component with more than two ports. Thus, a component with more than two ports can be part of multiple pipe runs, but each port must belong to at most one pipe run.

Piping Assembly - A collection of piping parts and/or other piping assemblies for the purpose of construction.

Piping Attachment Part - A piping support or pipe damping that connects to a pipe via an piping attachment.

Piping Attachment - A logical entity which connects a pipe damping or a piping support to a piping part. An attachment differs from a piping joint in that there is no potential for flow and the connectivity is to a piping part not to a piping port. This allows the pipe support or pipe damping to move along a pipe without modifying the pipe.

Piping Component - An element of a pipe run which is not a pipe. A piping component is an instance of a piping component definition. Examples of piping components are flanges, bosses, valves, elbows, tees, steam traps, filters, expansion joints, control valves, nozzles, relief valves, and orifice plates. It does not include equipment, supports, or pipe damping. This AP classifies piping components as unmodified or modified piping components.

Piping Component Definition - A set of data, describing a component, that is defined once and instanced zero, one, or many times at different locations and potentially different orientations within the piping model.

Piping Component Port - A type of piping port that locates where a component may join to a pipe, another component or a piece of equipment. The number of component ports must be equal to the number of component port definitions referenced by the piping component definition when the piping component definition is instanced.

Piping Component Port Definition - A point within the piping component definition that carries the definition space location, definition space orientation, and the port definition attributes when the component definition is instanced.

Piping Component Type - An attribute of a piping component which identifies the component as a commodity item, engineered item, or instrument.

Piping Envelope - A volume of space in the piping model that is used to represent the shape of piping parts or piping supports.

Piping Envelope Definition - A volume of space associated with a piping component definition, piping equipment definition, or piping support definition that is used to reserve space for the piping entity.

Piping Equipment - Piping equipment encompasses a wide variety of piping parts. Examples of piping equipment are pumps, vessels and machinery. Piping equipment, unlike a piping component, is not part of a pipe run. It must be connected to the start or the end of one or more pipe runs. This AP classifies piping equipment as unmodified or modified piping equipment.

Piping Equipment Definition - A set of data, describing a piece of equipment, that is defined once and instanced zero, one or many times at different locations and potentially different orientations within the piping model.

Piping Equipment Port - A type of piping port that locates where a piece of equipment may join to a pipe, component, or another piece of equipment. The number of equipment ports must be equal to the number of equipment port definitions referenced by the piping equipment definition when the piping equipment definition is instanced.

Piping Equipment Port Definition - A point within the Piping Equipment Definition that carries the location, orientation, type, and label of a equipment port when the component definition is instanced.

Piping Insulation - An entity that insulates a piping part. It is defined by a piping insulation definition.

Piping Insulation Definition - A standard combination of one or more layers of insulation with a material type and thickness.

Piping Joint - A logical entity which connects two piping ports belonging to two piping parts. Flow may occur through a piping joint.

Piping Port - A point that locates where a piping object may join to another piping object.

Piping Port Definition - A set of data, describing a piping port, that is defined once and instanced zero, one, or many times at different locations and potentially different orientations within the piping model.

Piping Specification - A source document that defines the set of piping components from which a piping system designer may select for building a piping system for a given process service. The definition of a piping component within a piping specification is complete enough to enable the purchase of the item.

Piping Support - An attachment part that supports one or more piping parts.

Piping Support Attach Point - The location at which a piping support is attached to a piping entity.

Piping Support Attach Point Definition - The location and label for the attach points of a piping support definition.

Piping Support Attachment - A logical entity which connects a piping support to a piping part.

Piping Support Definition - A standard combination of geometric constructs and attributes used for representing a type of piping support.

Piping System - A collection of one or many pipe runs and zero, one, or many pieces of equipment that performs a specific design function.

Port Definition Label - An identifier for a port definition consisting of up to ten alphanumeric characters.

Port Label - An identifier for a specific port consisting of up to ten alphanumeric characters.

Pressure Rating - A number that represents the allowable pressure at a piping component port.

Schedule - A number that represents a standard wall thickness as defined by ANSI (e.g., Schedule 40).

Slip Joint - A connection formed by slipping a flange over the end of a pipe or component and welding the flange in place.

Socket Weld - A type of mating between a pipe and a piping component or between two piping components where one end of the pipe or component is inserted into a socket of the mating component before welding. The end inserted into the socket is the male end, while the end containing the socket is the female end.

Stock Number - An identifier used for referencing a description of a part which is contained in a catalog. Depending upon company conventions, the stock number may or may not uniquely identify an item sufficiently for purchase. For example, the size(s) of the item may not be encoded into the stock number. Common aliases for Stock Number are "part number" or "commodity code."

Threaded - A mechanical mating between two piping components where one component is screwed over the other via a threaded connection. The end screwed over the other is the female end, while the end on the inside is the male end.

Unmodified Piping Component - A type of piping component which is defined by a piping component definition and does not have an added piping port or an installed access envelope. Compare with modified piping component.

Unmodified Piping Equipment - A type of piping equipment which is defined by a piping equipment definition and does not have an installed access envelope. Compare with modified piping equipment.

Wall Thickness - The thickness of a pipe wall (pipe outside radius minus pipe inside radius).

3.5 Application Reference Model

The 3D Piping IGES Application Protocol enables the exchange of the following piping entities:

- piping system
- pipe run
- piping assembly
- pipe
- unmodified piping component
- modified piping component
- piping component definition
- unmodified piping equipment
- modified piping equipment
- piping equipment definition
- piping support
- piping support definition
- pipe damping
- piping joint
- pipe damping attachment
- piping support attachment
- piping insulation

This section contains the 3D Piping Application Reference Model. This information model has been developed using a binary semantic modeling language called Nijssen Information Analysis Modeling (NIAM). An introductory guide to reading NIAM diagrams is provided in Appendix C.

Figure 3-5. Piping system and pipe run

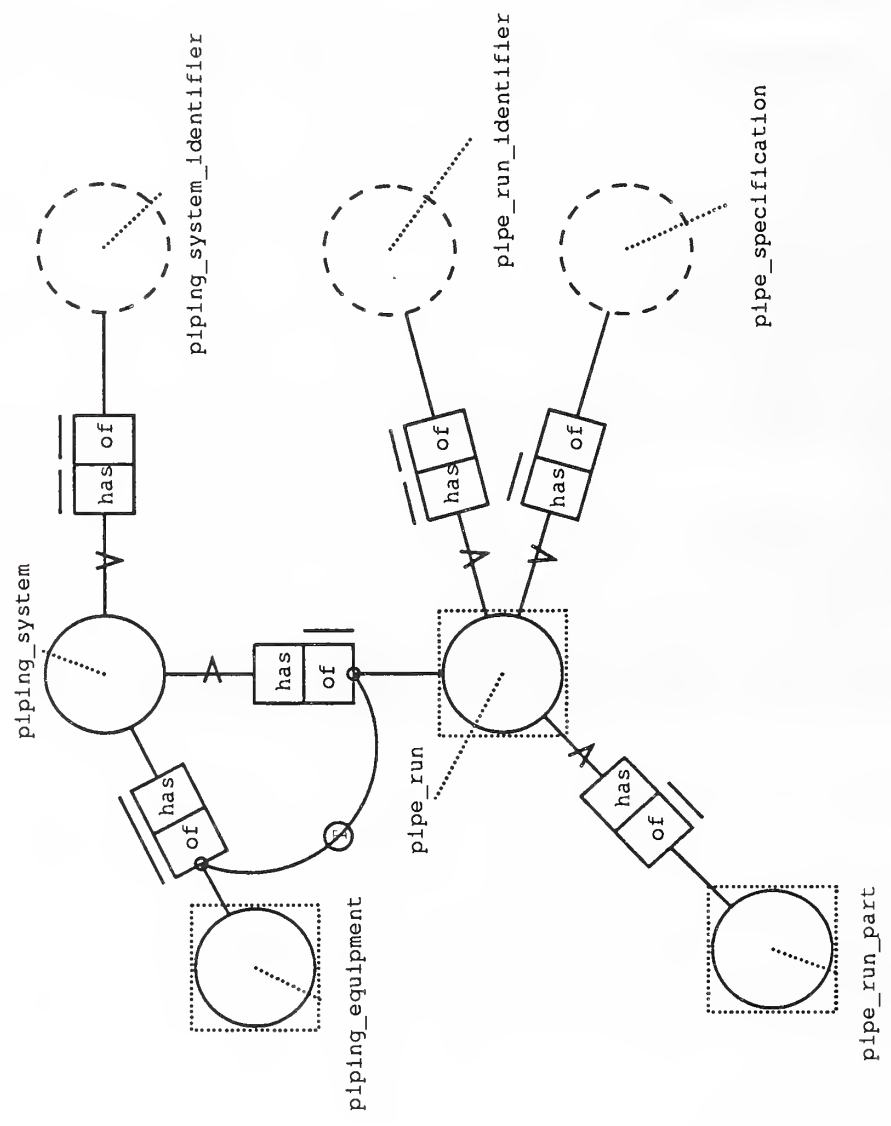

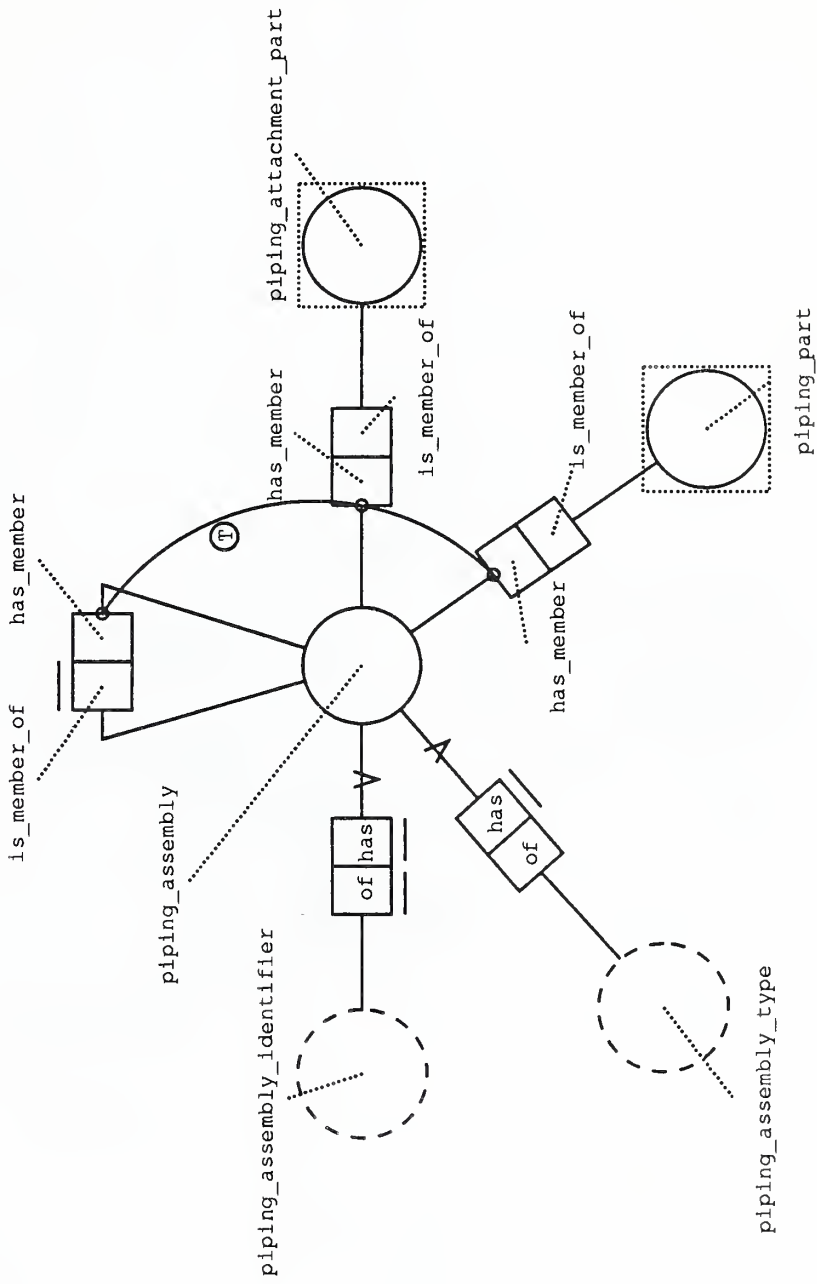
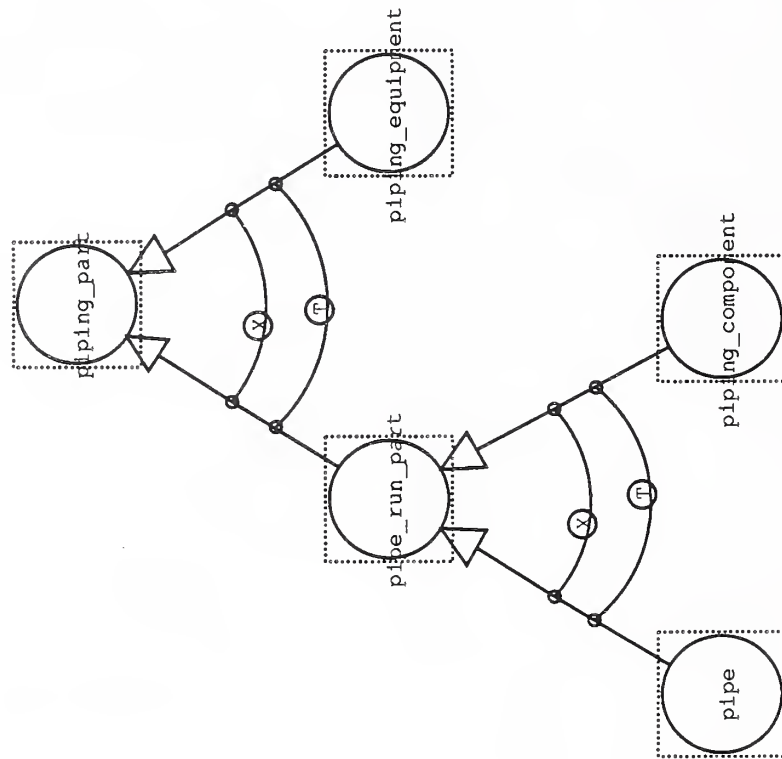

Figure 3-7. Piping part taxonomy



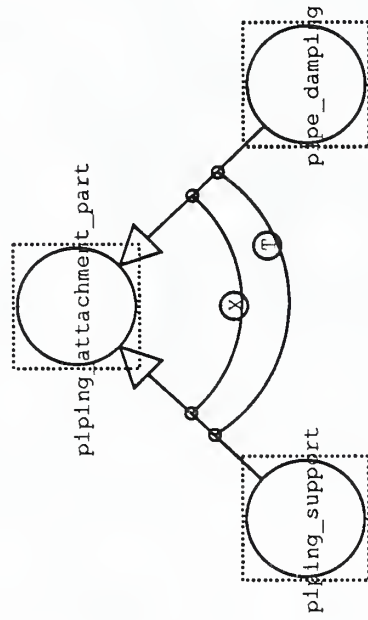

Figure 3-9. Piping port

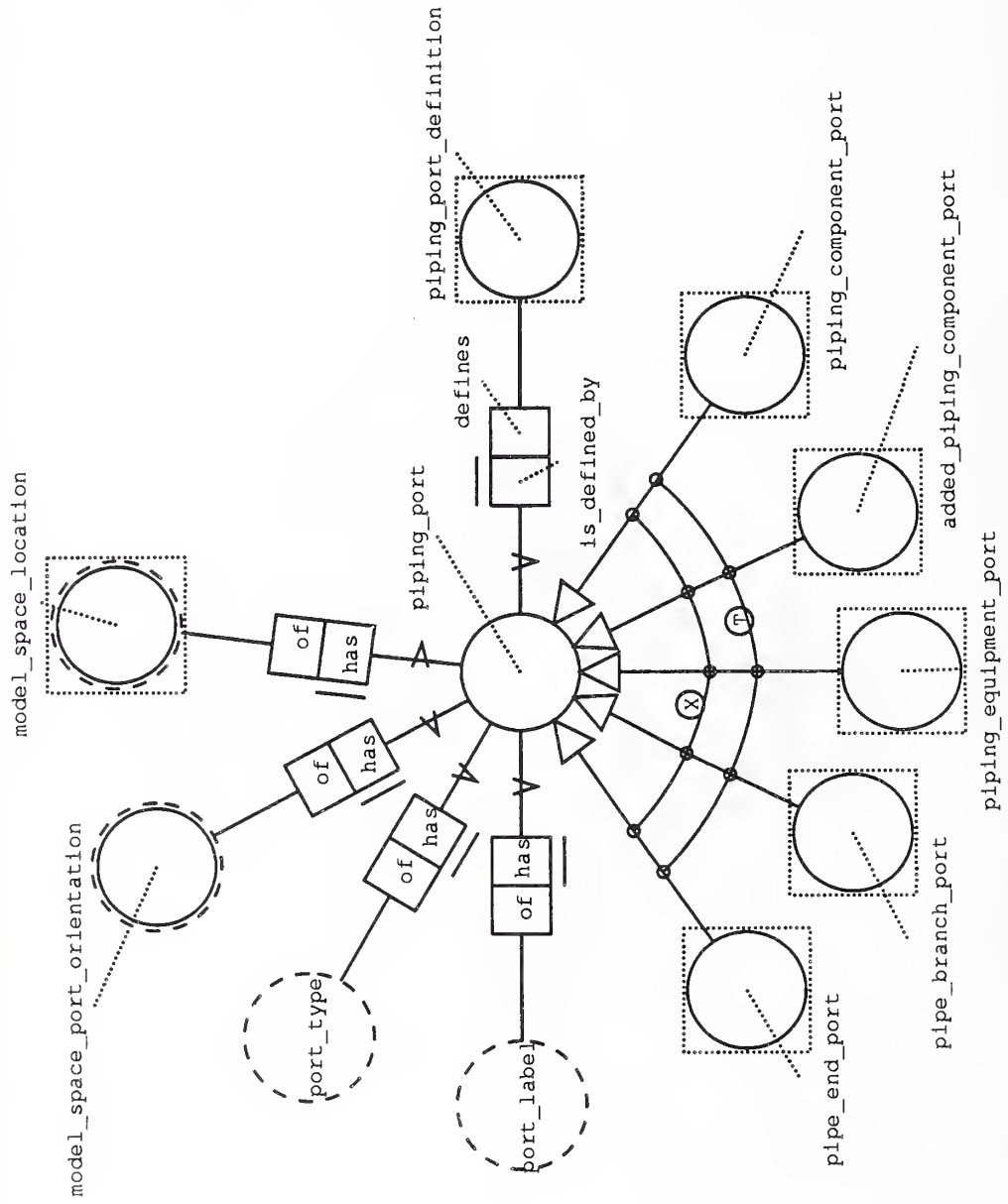

Figure 3-10. Piping port definition

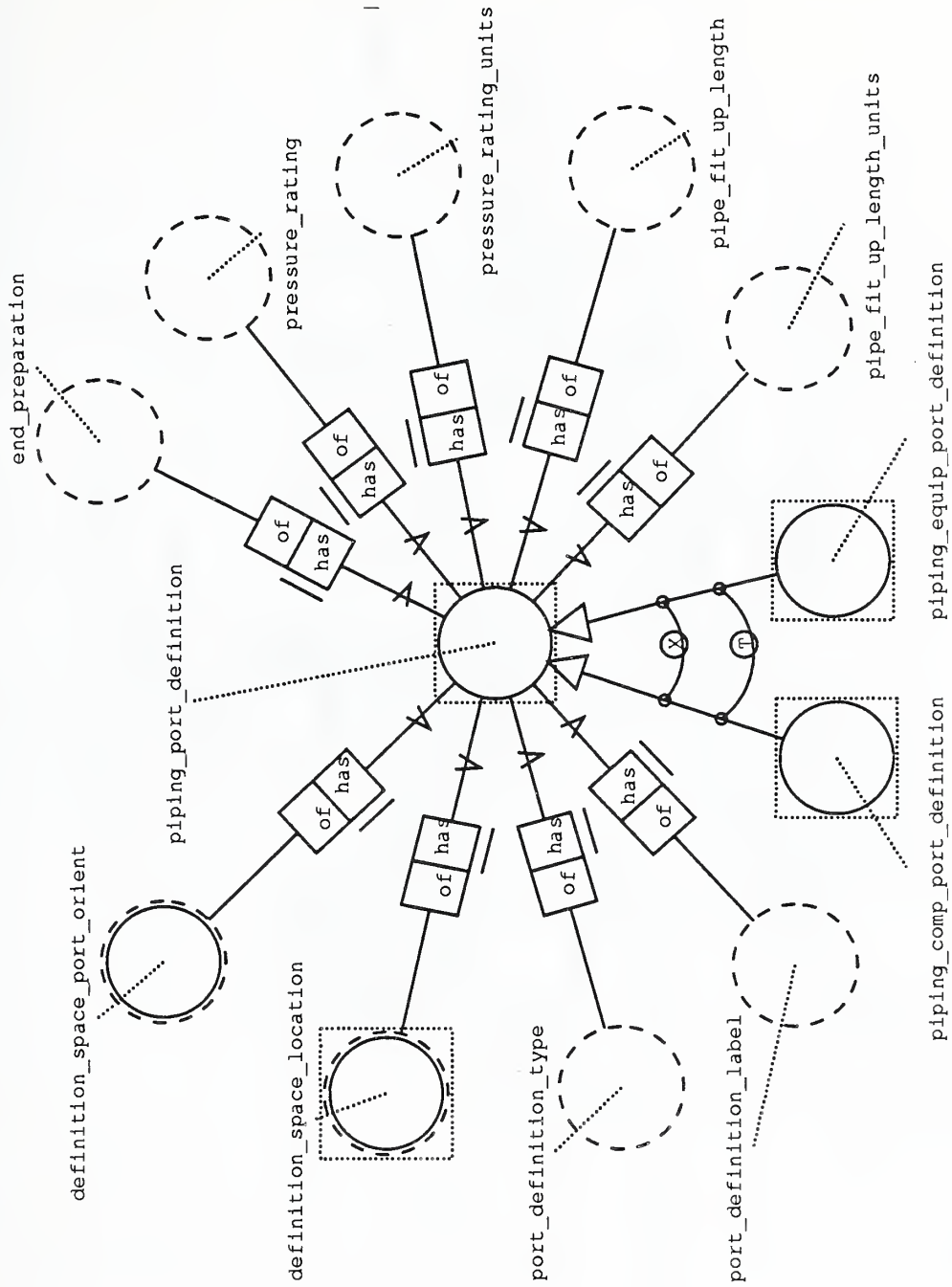
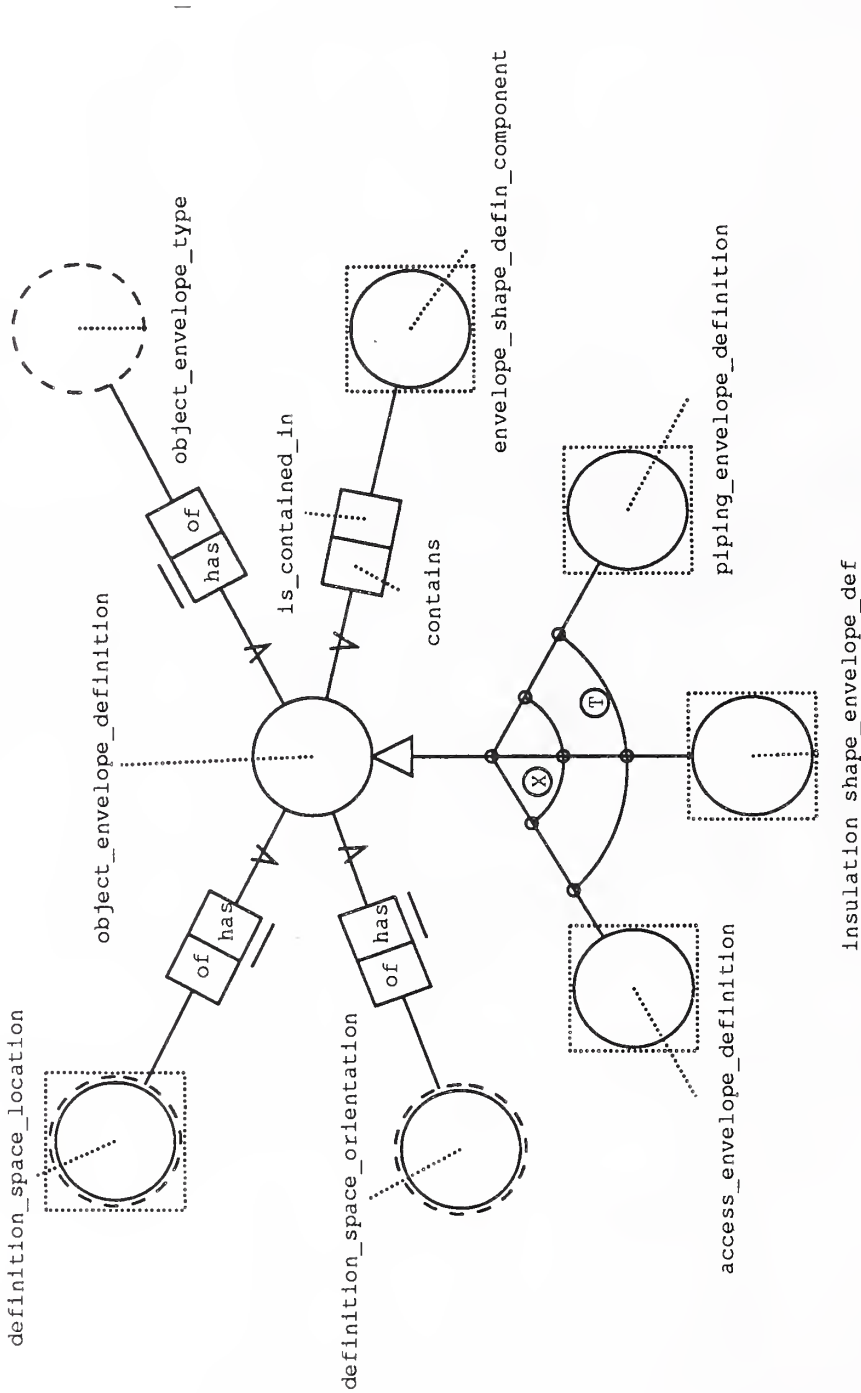

Figure 3-11. Object envelope definition



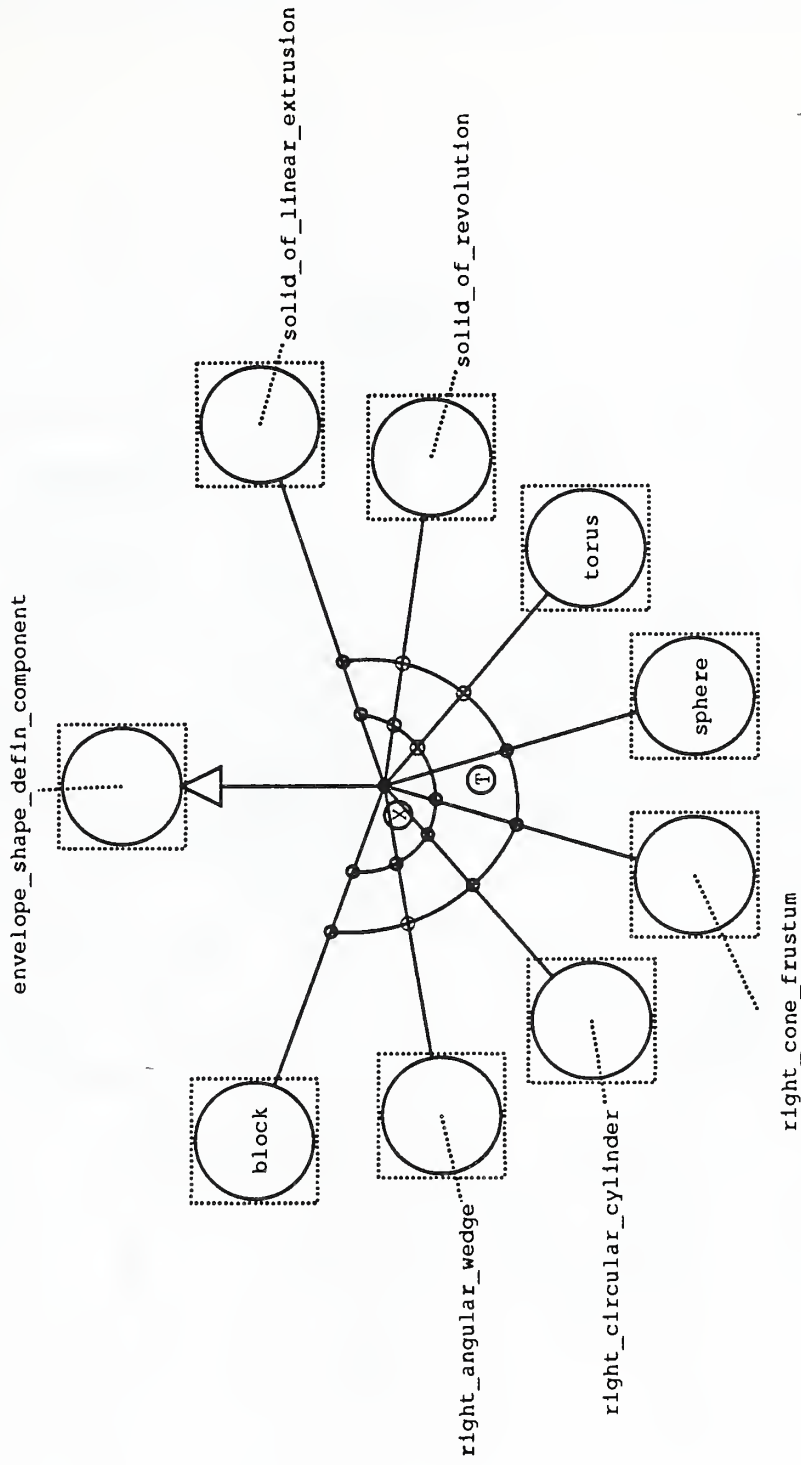
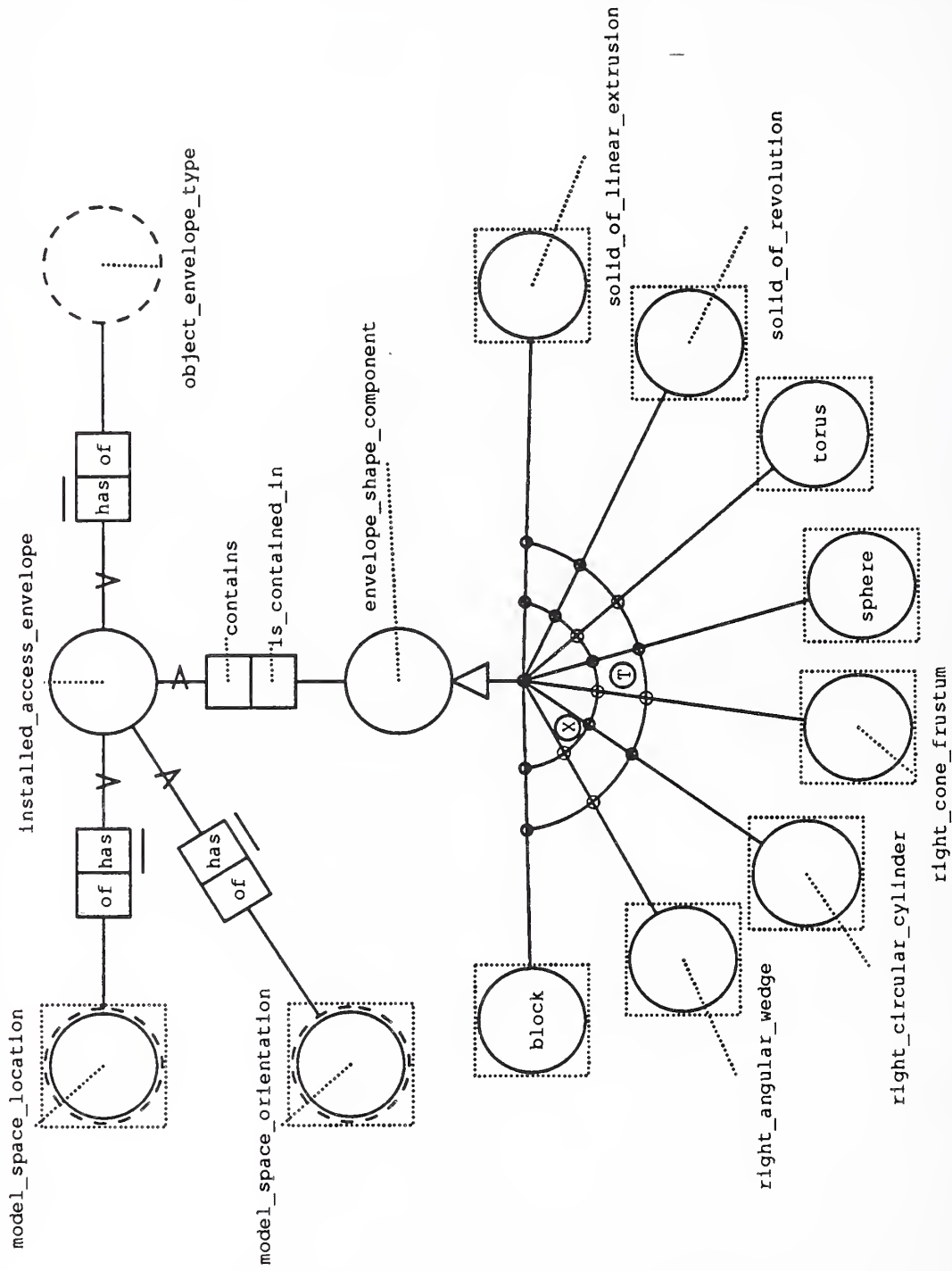
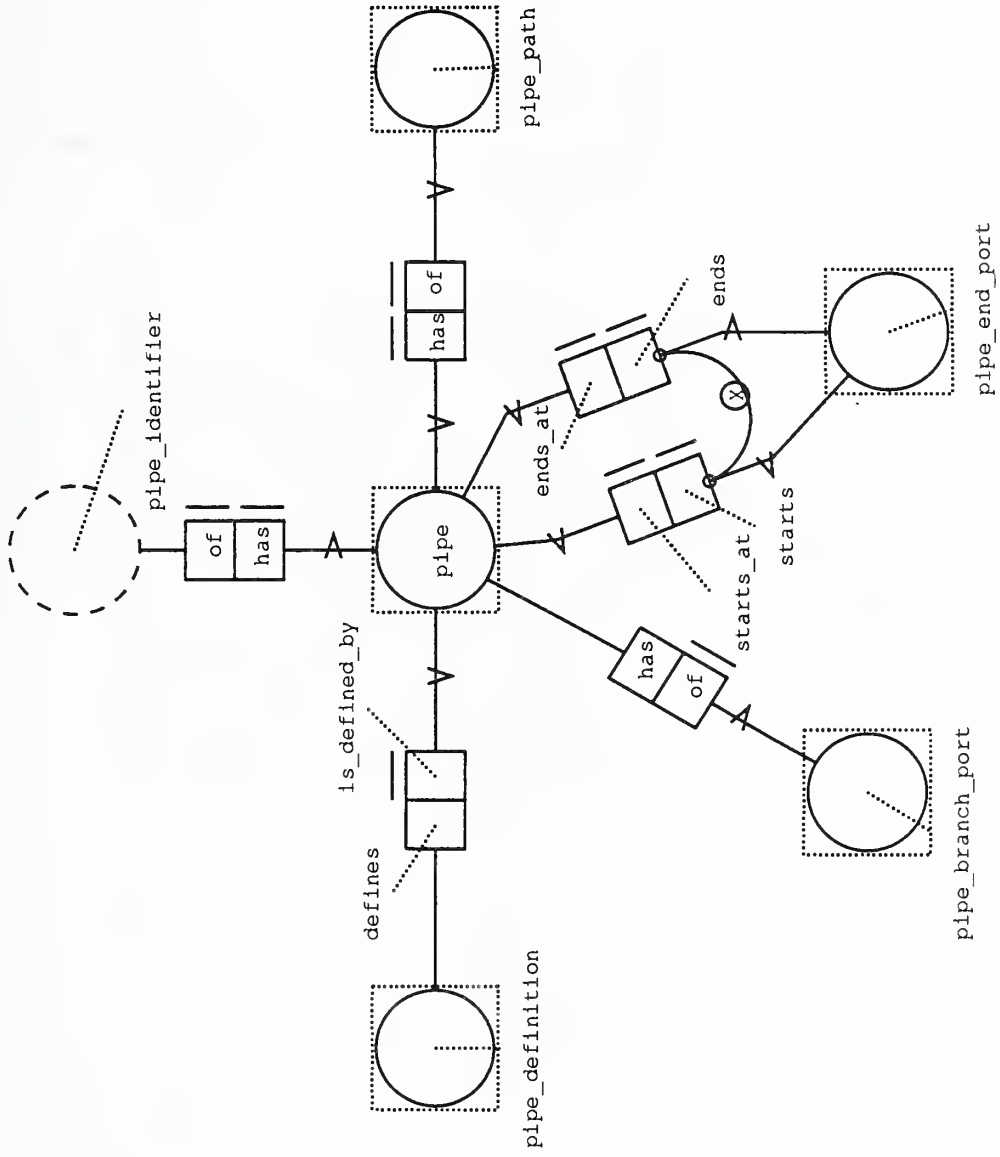
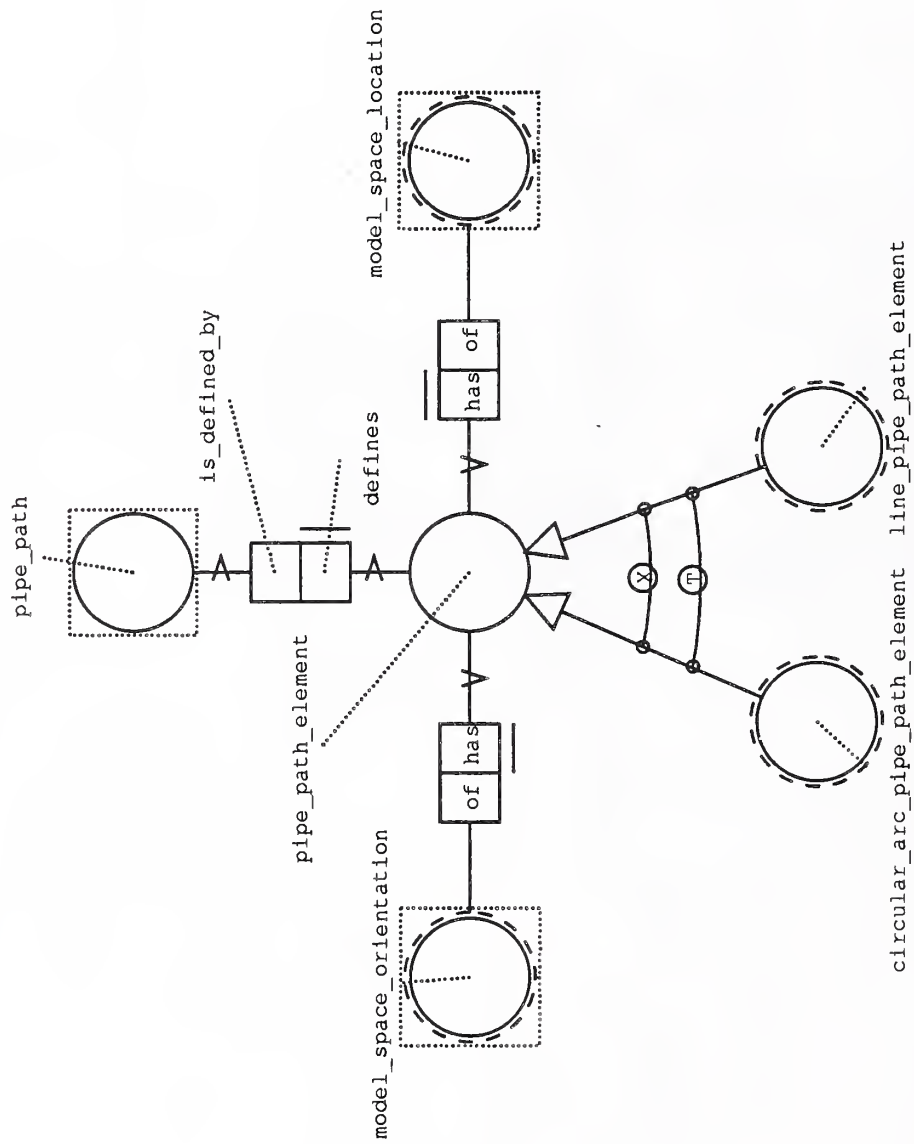

Figure 3-13. Installed access envelope







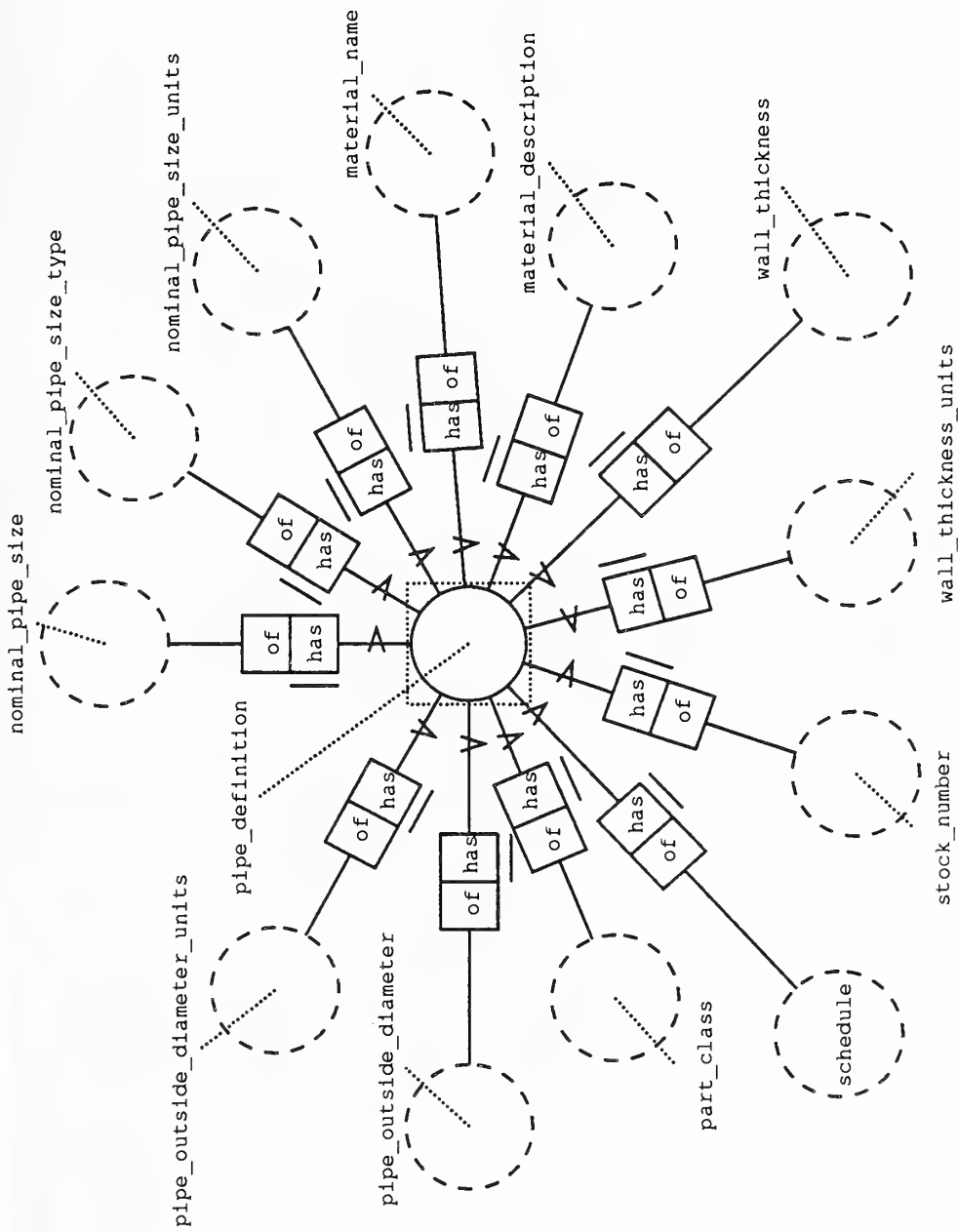

Figure 3-17. Piping component

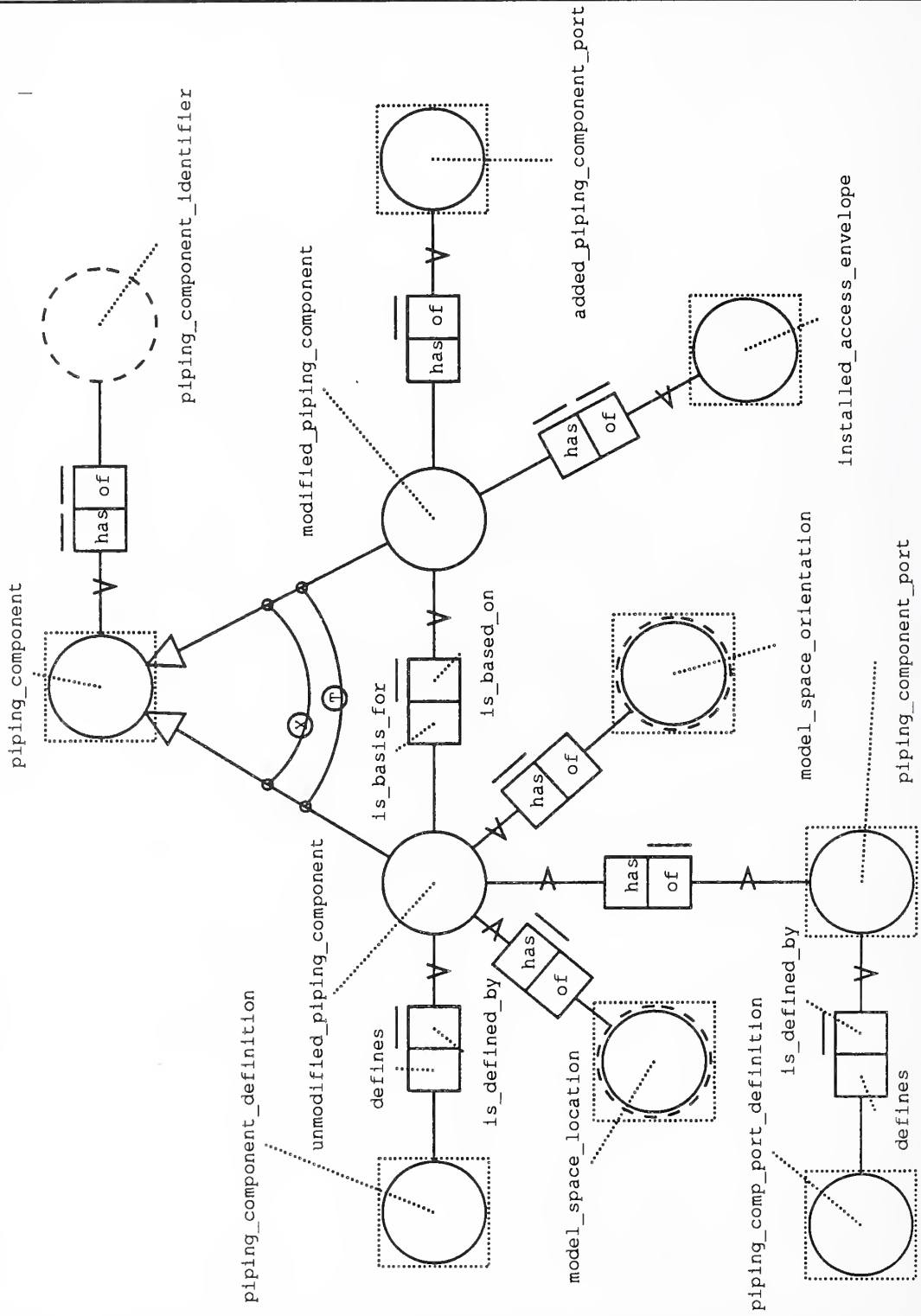
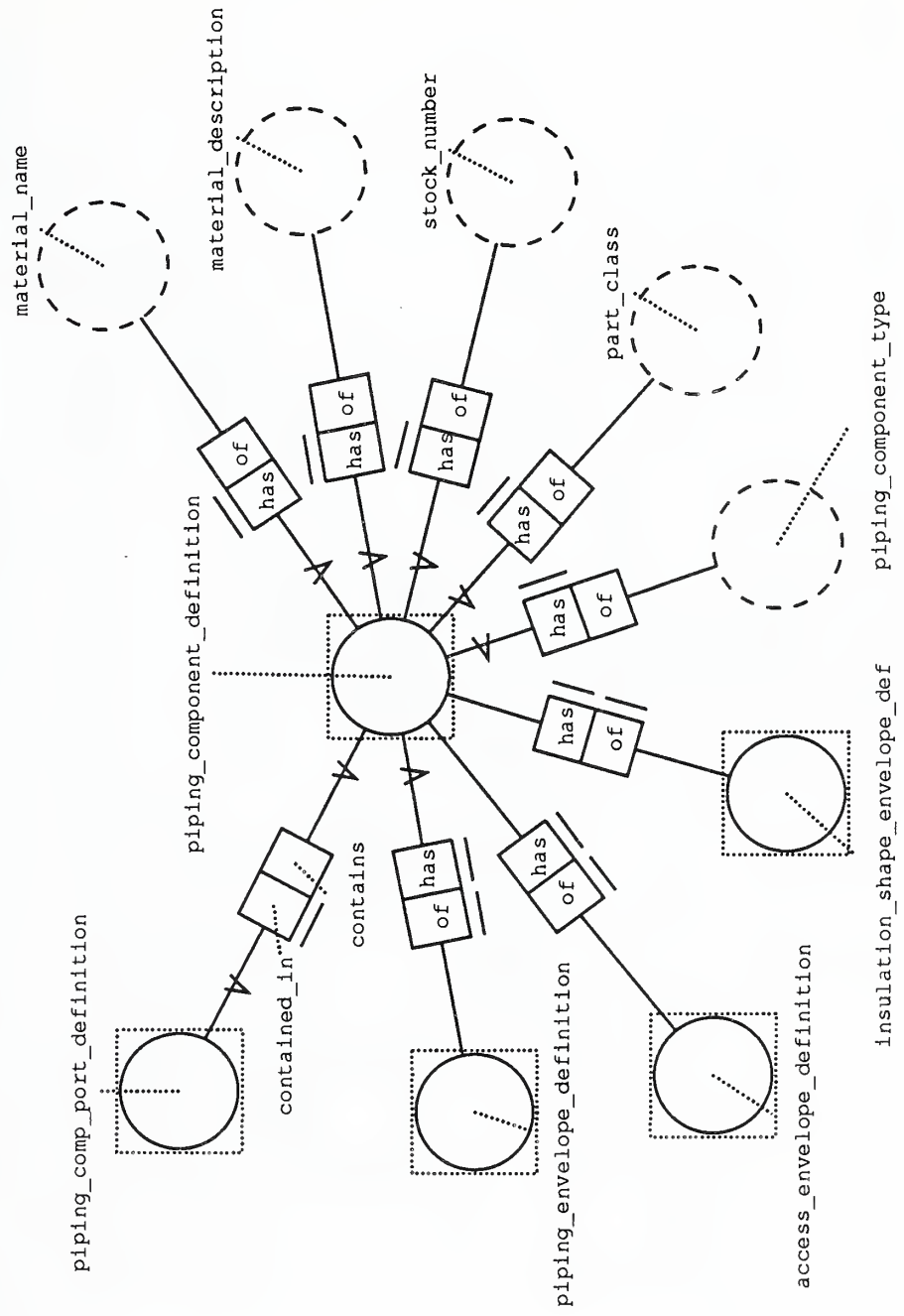
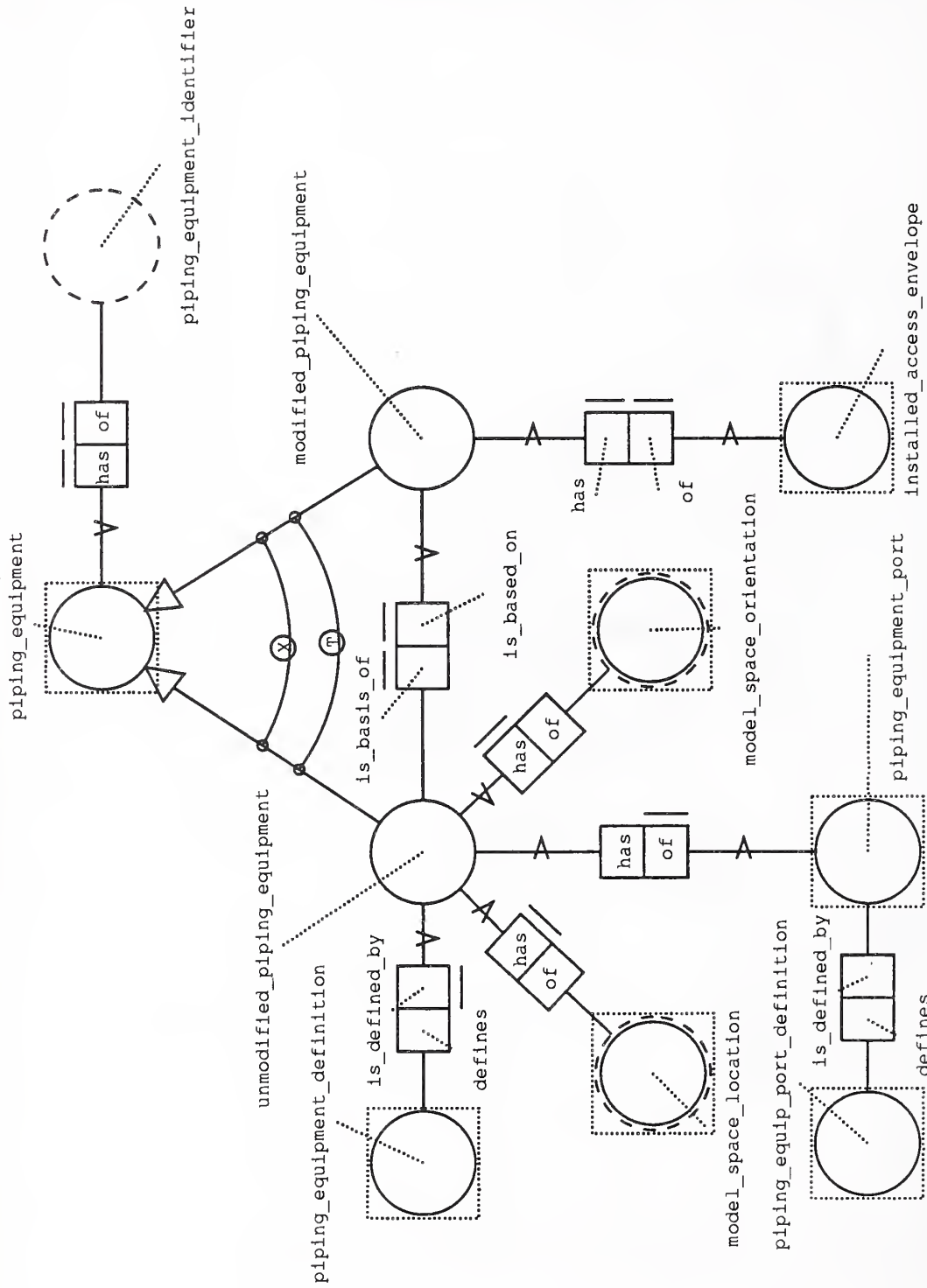
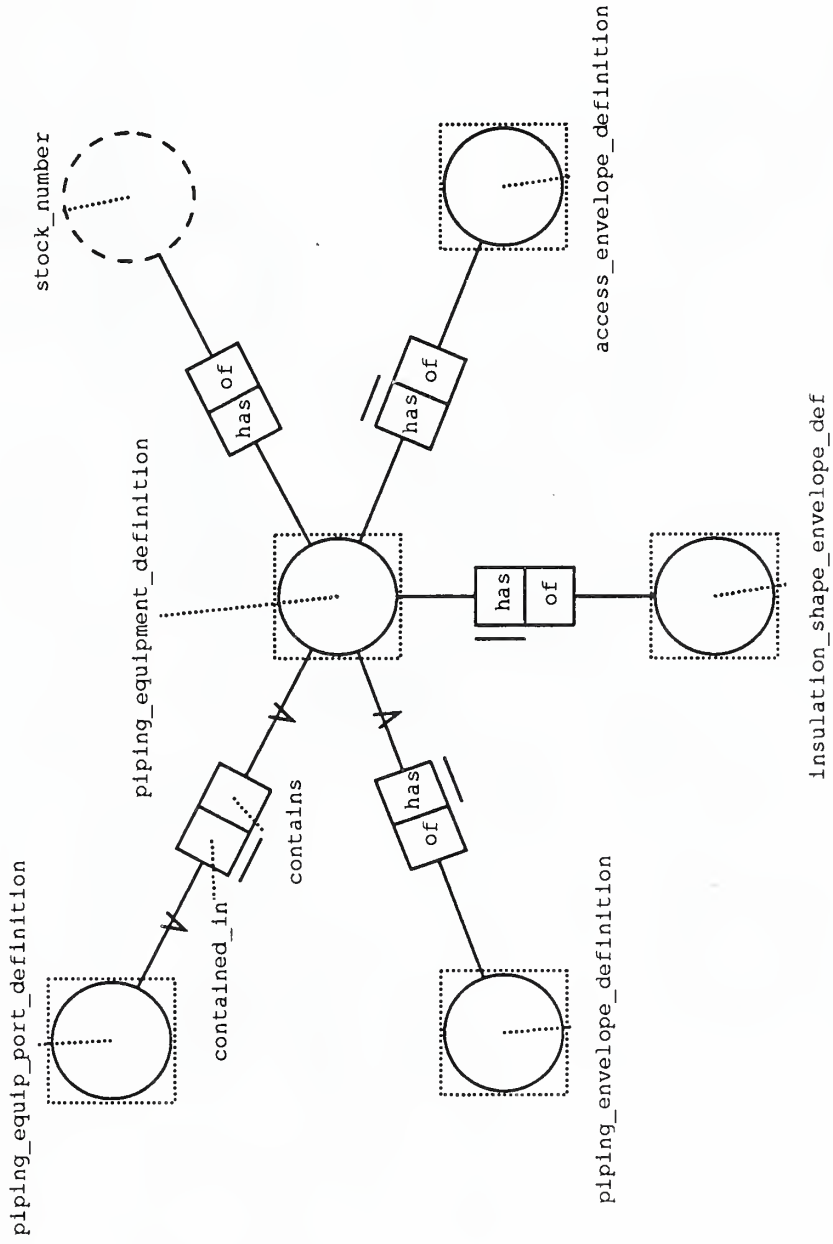

Figure 3-18. Piping component definition







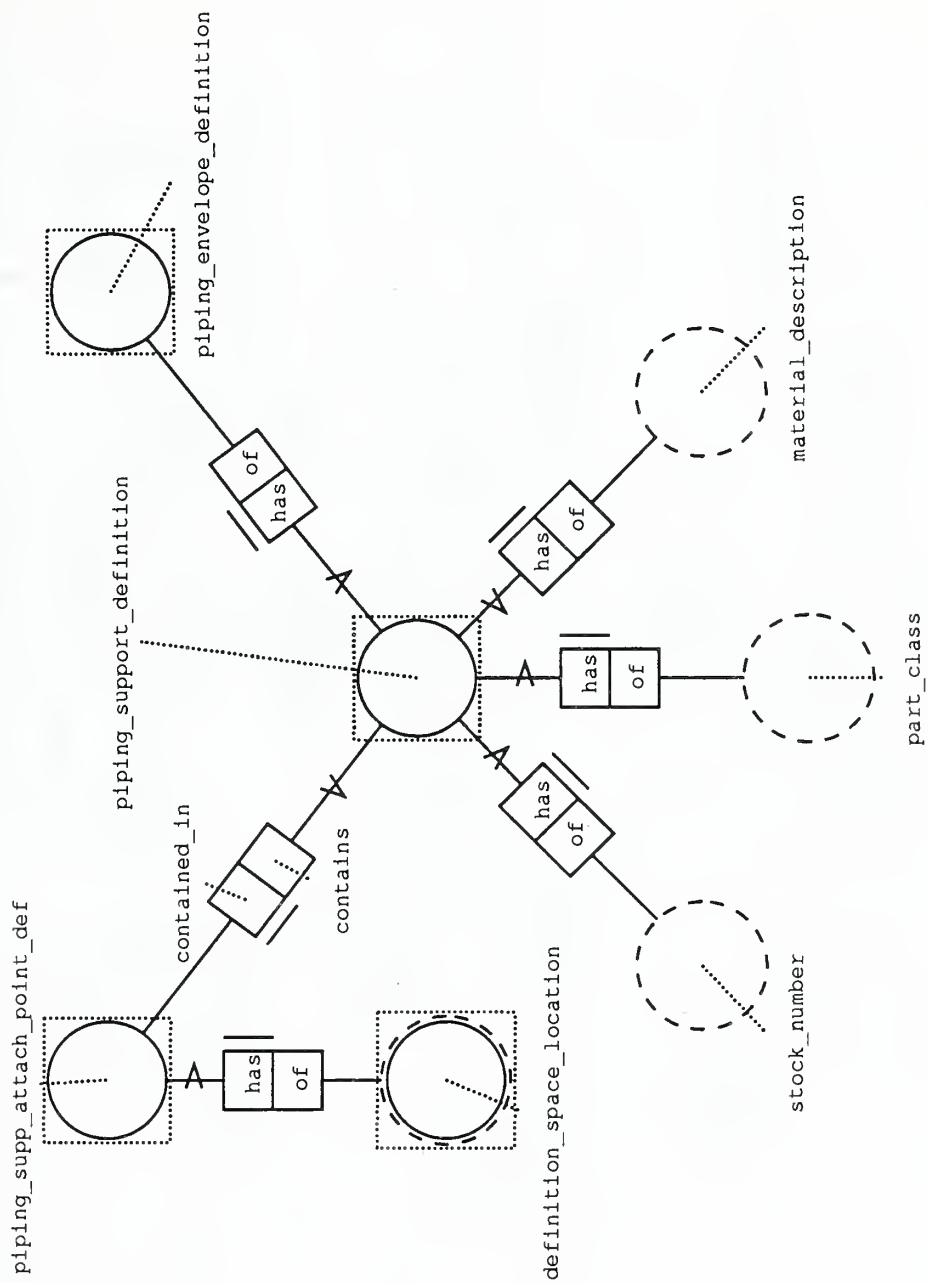
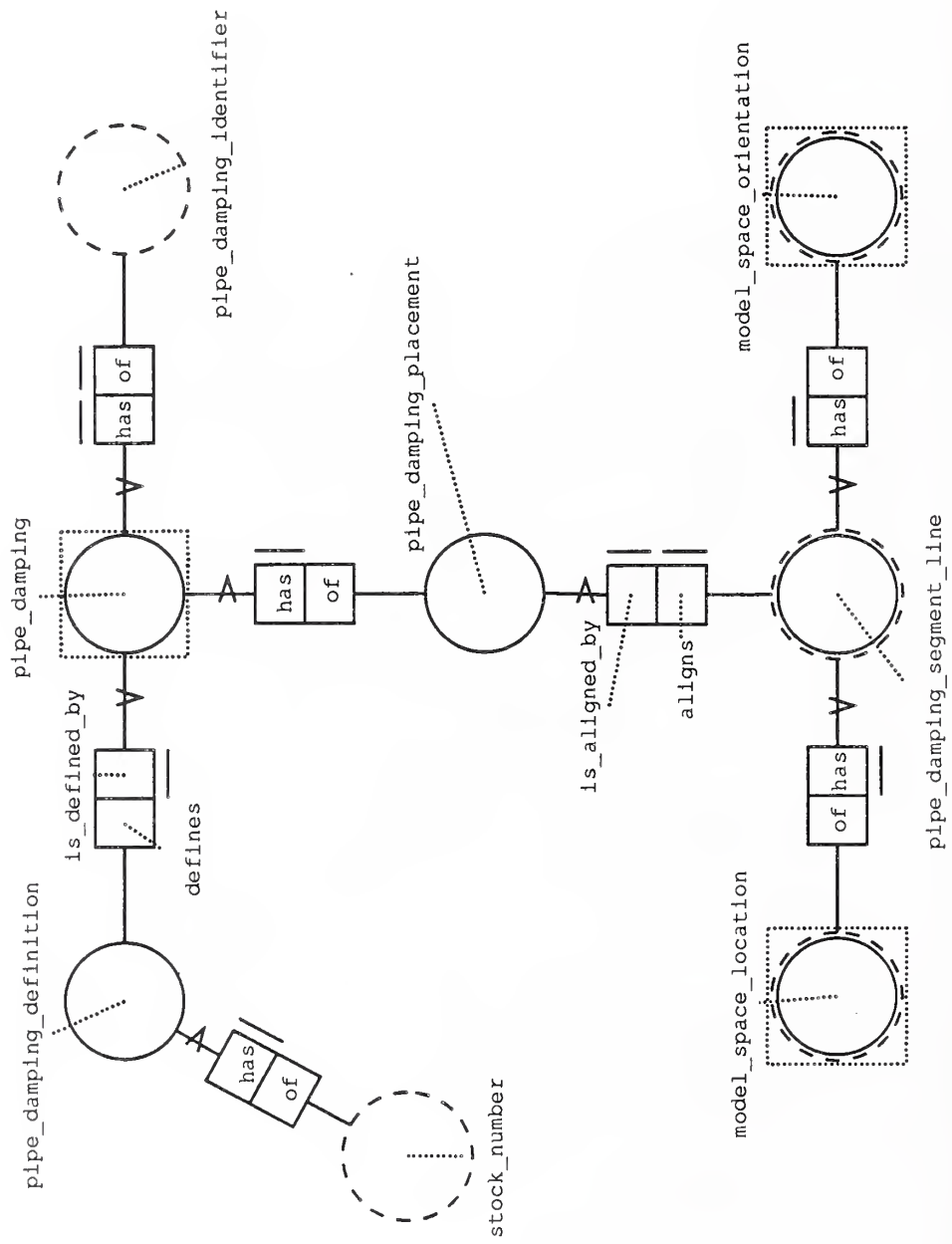
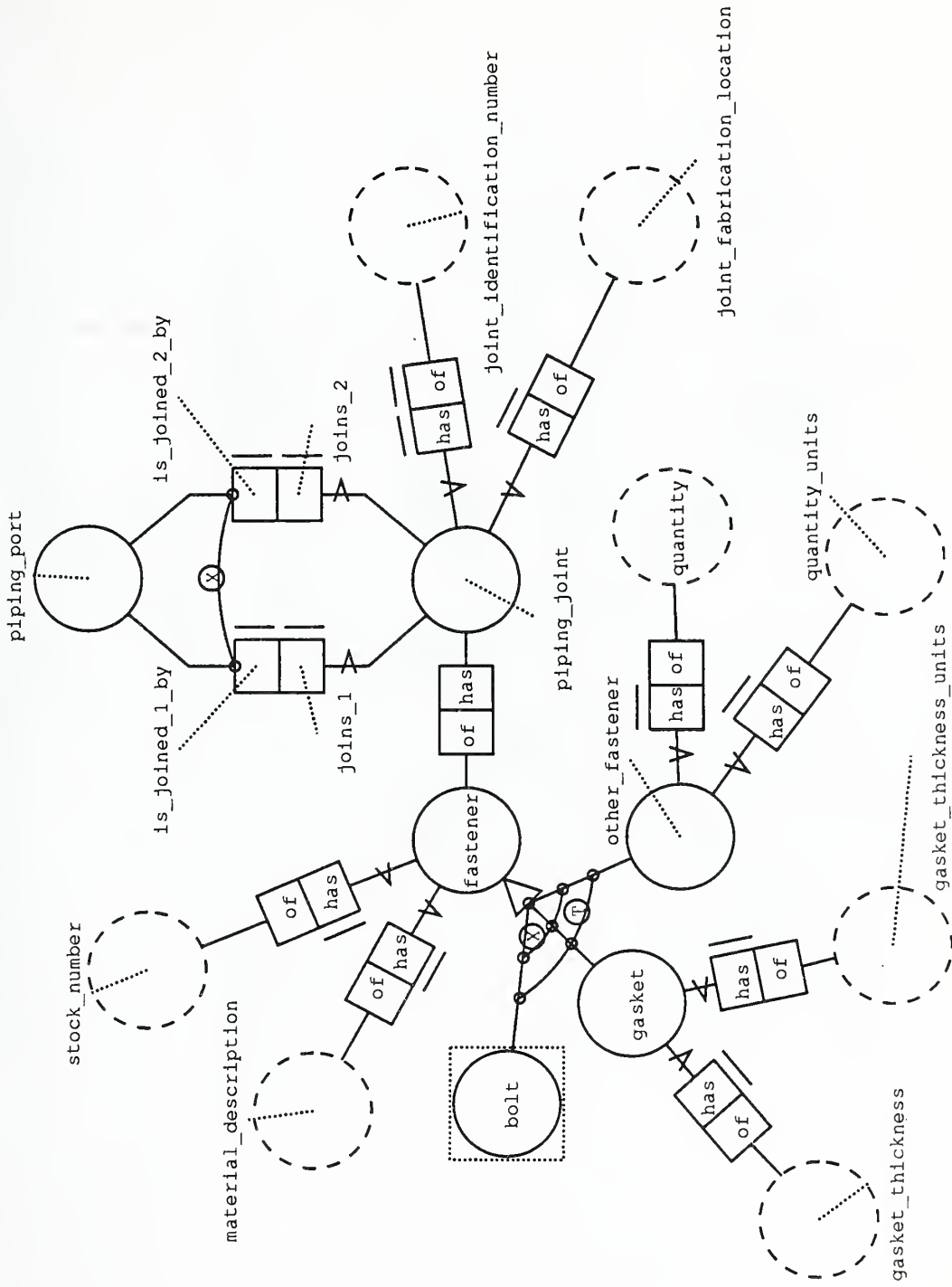

Figure 3-23. Pipe damping





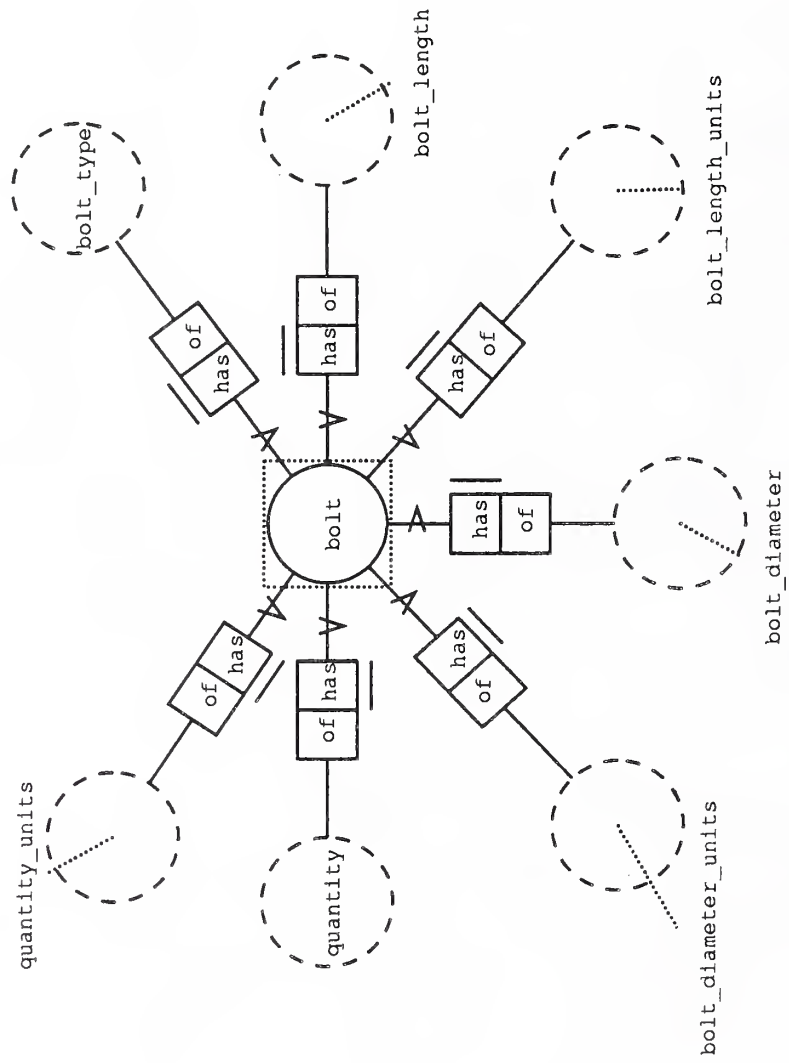

Figure 3-26. Piping attachment

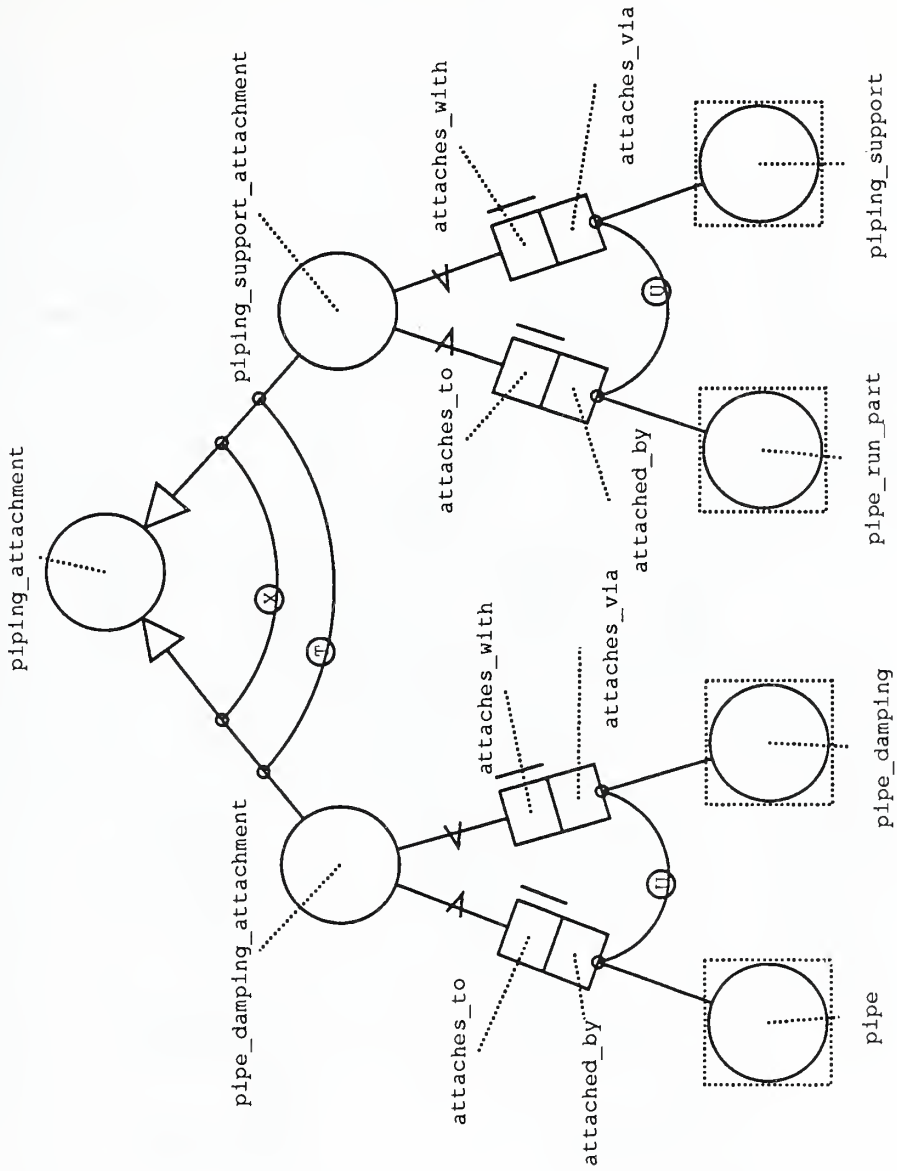
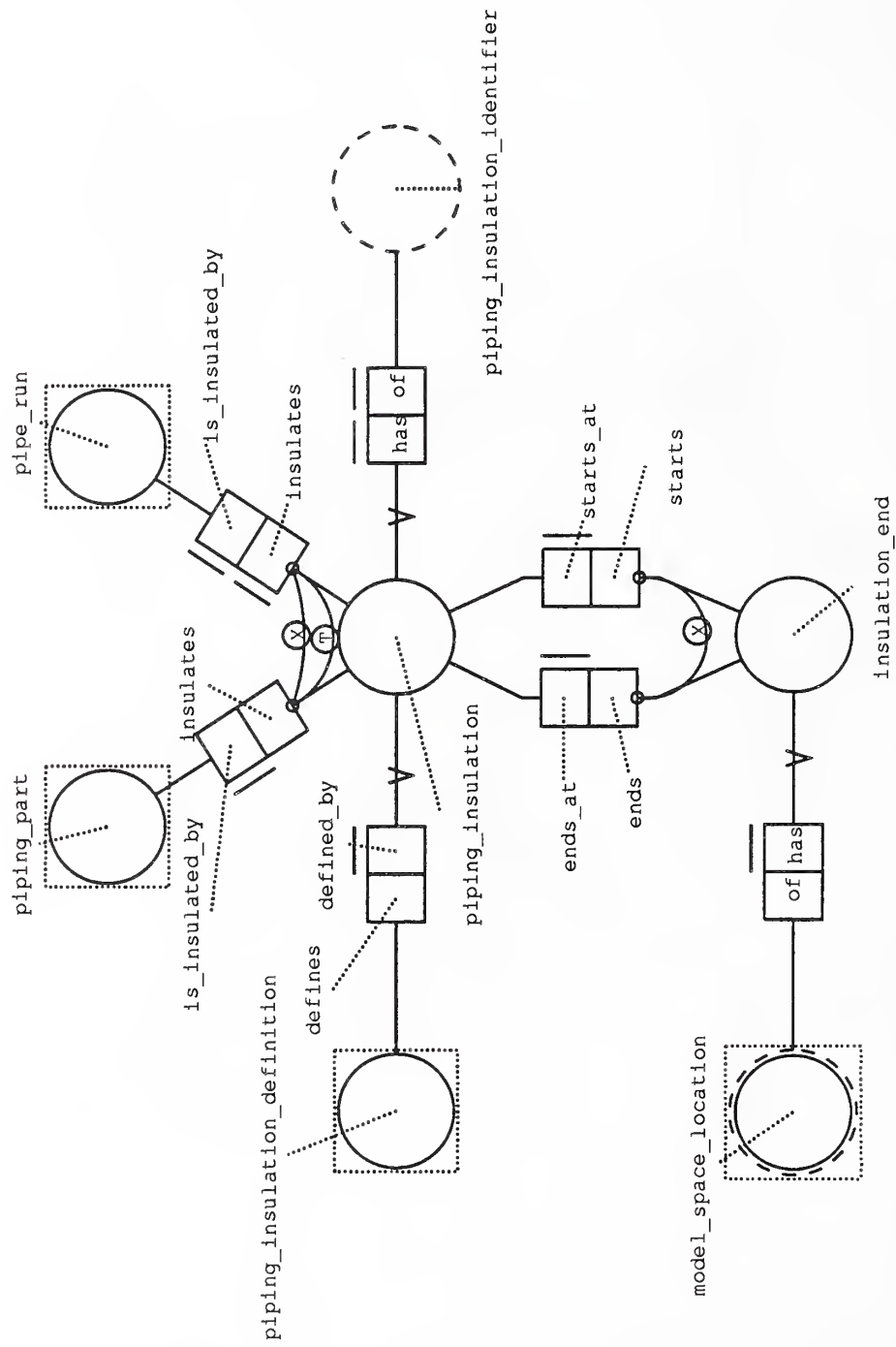
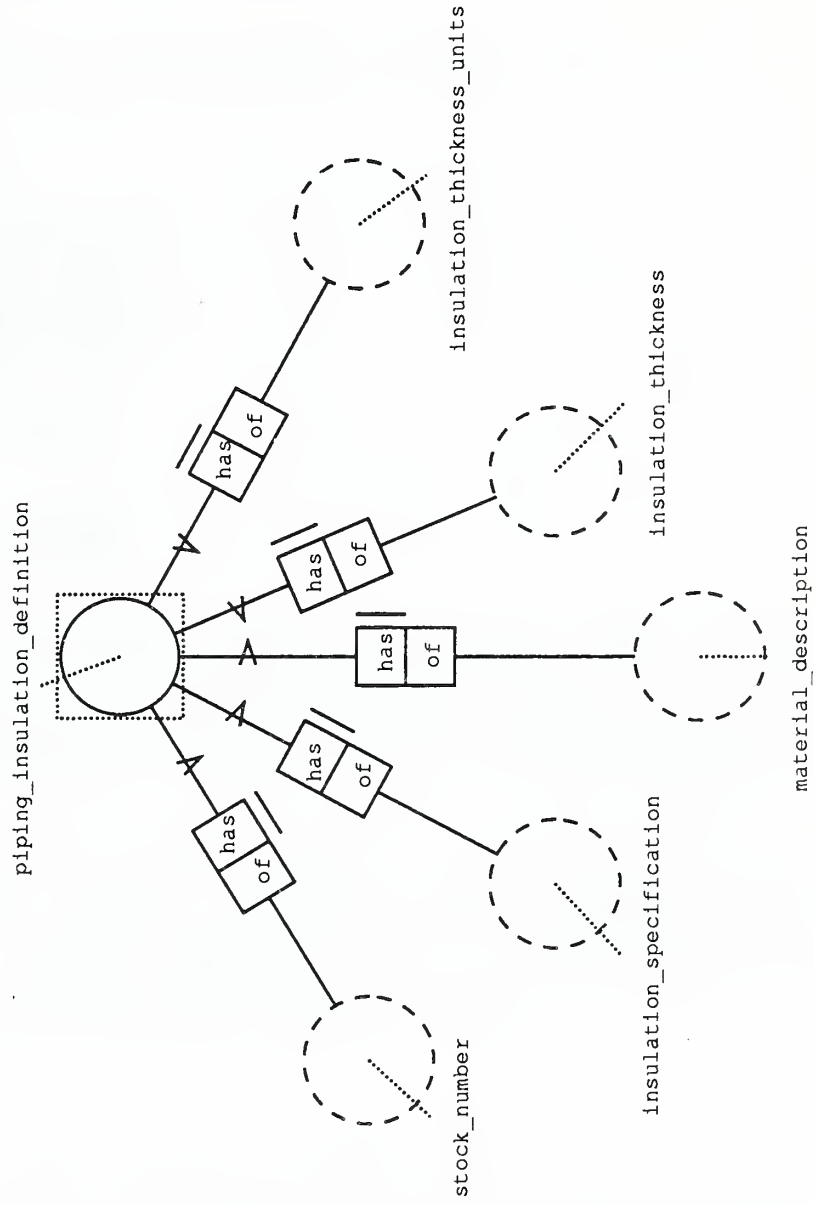

Figure 3-27. Piping insulation





4. 3D PIPING IGES APPLICATION INTERPRETED MODEL

The 3D Piping IGES Application Protocol enables the exchange of the following piping entities:

- piping system
- pipe run
- piping assembly
- pipe
- unmodified piping component
- modified piping component
- piping component definition
- unmodified piping equipment
- modified piping equipment
- piping equipment definition
- piping support
- piping support definition
- pipe damping
- piping joint
- pipe damping attachment
- piping support attachment
- piping insulation

This section provides the 3D Piping IGES Application Interpreted Model (AIM) and the AP Format Specification. Each figure of the AIM is followed by the requirements for the Directory Entry and Parameter Data Sections of each of the specified IGES constructs. The second digit of an AIM figure number is used as the third digit of the corresponding sub-section number (e.g.; Figure 4-3 is followed by sub-section 4.2.3.). Appendix D provides a summary of all AIM figures without the requirements for the Directory Entry and Parameter Data Sections. Appendix E explains the nomenclature of IGES AIM diagrams.

The 3D Piping IGES Application Protocol is intended for 3D piping system applications and not general purpose CAD systems. Since the AP makes use of a specific interpretation of entities in the IGES file, both the sending and receiving sites **must** support the 3D piping system application, not just the IGES entities listed. AP compliant processors must support all constructs listed in this section. If the value of a specified piping object attribute has not been assigned, the standard null value must be transferred into and out of the required field of the IGES AP file.

4.1 IGES File Structure

An IGES file consists of 5 sections appearing in the following order: Start, Global, Directory Entry, Parameter Data, and Terminate. All parameters for these sections must be in accordance with Reference 1. Character strings must be encoded in the Hollerith form as specified in section 2.2.2.3 of Reference 1, with the exceptions of the Start Section and Directory Entry Entity Labels. Additional requirements on these sections are presented below.

To exchange a complex piping model, the sender will produce two types of valid IGES Version 5.0 files, an INSTANCE and a DEFINITION file. The INSTANCE file defines the geometry, connectivity, and relationships of one or more piping objects. It also contains references to a DEFINITION file which defines the detailed geometry and connectivity of piping parts such as valves used in the model. A DEFINITION file may be referenced by either a single or multiple INSTANCE files. For example, a large system may be represented by several INSTANCE files, each covering a portion of the system; these in turn could all reference the same DEFINITION file for piping part data.

4.1.1 Start Section

The following information shall be placed in the start section of an INSTANCE or DEFINITION file:

- a) Statement of conformance to this AP
- b) Revision level of the INSTANCE or DEFINITION file
- c) CAD model author and date of the IGES AP file creation
- d) Enough information to clearly convey the data content and location.

4.1.2 Global Section

Fields in the global section shall be set as indicated. Those listed as "Optional" do not have a required value. A preprocessor may set "Optional" fields to system default values, and a postprocessor may ignore the values in these fields. Those listed as "No" are not meaningful to this transfer and should be ignored.

<u>FIELD</u>	<u>VALUE</u>	<u>REQUIRED</u>	<u>NOTES</u>
1	1H,	Yes	Standard default
2	1H;	Yes	Standard default
3	8HINSTANCE or 10HDEFINITION	Yes	Piping model type
4	File name	Yes	80 Character count max
5	Sending System Identifier	Yes	40 Character count max
6	Translator Version	Yes	20 Character count max
7	No. Bits for Integer	Optional	
8	Single Precision Magnitude	Optional	
9	Single Precision Significance	Optional	
10	Double Precision Magnitude	Optional	
11	Double Precision Significance	Optional	
12	Product ID for Receiver	Optional	
13	1.0	Yes	Standard default
14	1	Yes	Unit flag = Inches
15	2HIN	Yes	Units = Inches
16	Max. Number of Line Weight	No	
17	Size of Max. Line Weight	No	
18	13HYMMDD.HHNNSS	Yes	Time generated
19	Min. User Intended Resolution	No	
20	Approx. Max. Coordinate Value	No	
21	Name of Author	Optional	20 Character count max
22	Organization	Yes	20 Character count max
23	8 or Later	Yes	IGES Version
24	Applicable Drafting Standard	No	
25	Date and Time Model was Created or Modified	No	

4.1.3 Directory Entry Section

The Directory Entry (DE) Section is designed to provide an index of descriptive attributes about each of the IGES entities used to represent 3D piping data.

Notes for the Directory Entry Tables:

1. The value for this field will be the sequence number of the first line of this entity's parameter data record. The letter "P" will not be included.
2. The value for this field will be the physical count of this line from the beginning of the Directory Entry Section. The number will be odd and preceded by the letter "D".
3. The value for this field will be the total number of lines in this entity's parameter data record.
4. The value for this field will be the physical count of this line from the beginning of the Directory Entry Section. The number will be even and preceded by the letter "D".
5. The value for this field will be the sequence number for the first directory entry line of the Transformation Matrix (Entity 124) that defines the orientation. A zero implies that an identity transformation matrix and zero translation vector will be used. The letter "D" will not be included.
6. The value for this field will be a negative number. The absolute value of this number will be the sequence number of the first directory entry line for an Attribute Table Definition (Entity 322, Form 0). The letter "D" will not be included.
7. The optional value for this field will be an eight character string identifying the IGES entity. The field will be left blank if a character string is not specified for the IGES entity.
8. The optional value for this field is a numeric qualifier for the entity label (field 18).

4.1.4 Parameter Data Section

The Parameter Data (PD) Section provides the specific IGES entity definitions that represent piping data. This section uses free format fields which are separated by the IGES default parameter delimiter character ",".

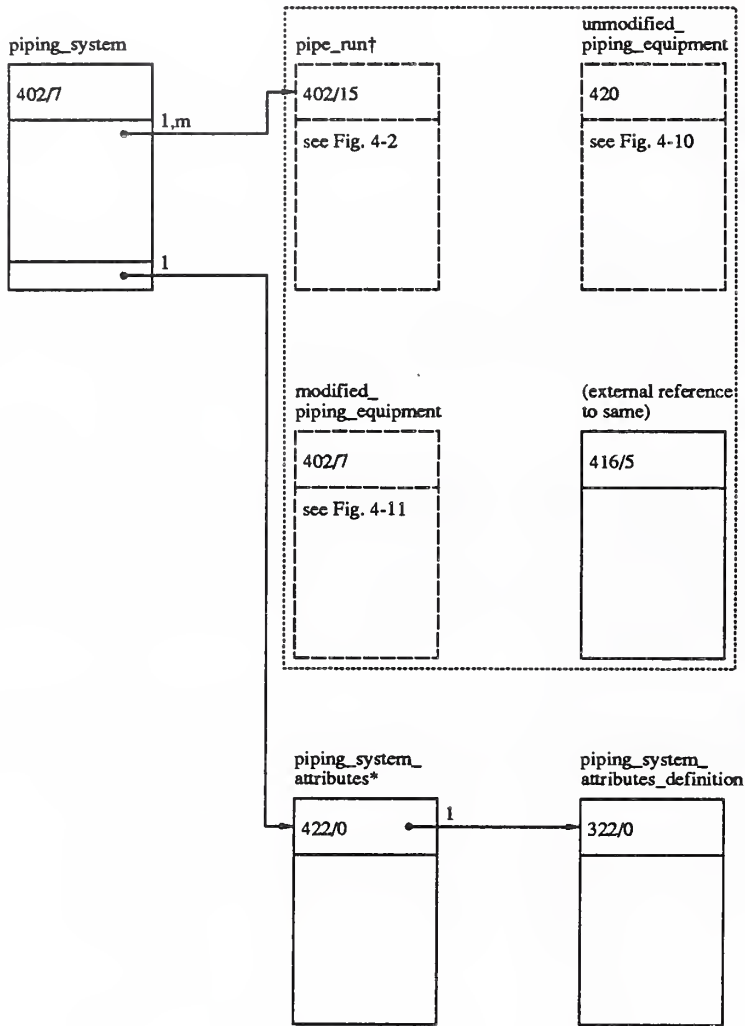

†Rule:
at least one pipe_run shall occur
in a piping_system structure

*Note:
piping_system_attributes are:
piping_object_type
piping_system_identifier

4.2 Piping IGES Constructs

4.2.1 Piping System

4.2.1.1 Piping System Group Associativity (Entity 402, Form 7)

Directory Entry

<u>Field #</u>	<u>Field Name</u>	<u>Description</u>
1	Entity Type Number	402
2	Parameter Data	Pointer to corresponding PD record, see Note 1
3	Structure	0 or blank
4	Line Font Pattern	0 or blank
5	Level	0 or blank
6	View	0 or blank
7	Transformation Matrix	0 or blank
8	Label Pointer	0 or blank
9A	Blank Status	00
9B	Subordinate Switch	00
9C	Entity Use	03
9D	Hierarchy	00
10	Sequence Number	DE line number, see Note 2
11	Entity Type Number	402
12	Line Weight	0 or blank
13	Color Number	0 or blank
14	Parameter Line Count	Number of lines in PD record, see Note 3
15	Form Number	7
16	Reserved	Blank
17	Reserved	Blank
18	Entity Label	Optional, see Note 7
19	Entity Subscript No.	Optional, see Note 8
20	Sequence Number	DE line number, see Note 4

Parameter Data

<u>Index</u>	<u>Description</u>
1	Number of entity pointers (= N, where $N \geq 1$)
2	Pointer to one of the following: - pipe run group associativity (Entity 402/15) - unmodified piping equipment network subfigure instance (Entity 420) - modified piping equipment group associativity (Entity 402/7) - external reference (Entity 416/5)
.	.
.	.
.	.
N+1	Pointer to one of the following: - pipe run group associativity (Entity 402/15) - unmodified piping equipment network subfigure instance (Entity 420) - modified piping equipment group associativity (Entity 402/7) - external reference (Entity 416/5)
N+2	Number of associativity instance pointers (= 0 or blank)
N+3	Number of property pointers (= 1)
N+4	Pointer to piping system attributes (Entity 422/0)

4.2.1.2 External Reference (Entity 416, Form 5)

Directory Entry

<u>Field #</u>	<u>Field Name</u>	<u>Description</u>
1	Entity Type Number	416
2	Parameter Data	Pointer to corresponding PD record, see Note 1
3	Structure	0 or blank
4	Line Font Pattern	0 or blank
5	Level	0 or blank
6	View	0 or blank
7	Transformation Matrix	0 or blank
8	Label Pointer	0 or blank
9A	Blank Status	00
9B	Subordinate Switch	00
9C	Entity Use	04
9D	Hierarchy	00
10	Sequence Number	DE line number, see Note 2
11	Entity Type Number	416
12	Line Weight	0 or blank
13	Color Number	0 or blank
14	Parameter Line Count	Number of lines in PD record, see Note 3
15	Form Number	5
16	Reserved	Blank
17	Reserved	Blank
18	Entity Label	Optional, see Note 7
19	Entity Subscript No.	Optional, see Note 8
20	Sequence Number	DE line number, see Note 4

Parameter Data

<u>Index</u>	<u>Description</u>
1	External reference entity symbolic name - for pipe run = pipe run identifier - for unmodified piping equipment = piping equipment identifier - for modified piping equipment = piping equipment identifier
2	Number of associativity instance pointers (= 0 or blank)
3	Number of property pointers (= 0 or blank)

4.2.1.3 Piping System Attributes (Entity 422, Form 0)

Directory Entry

<u>Field #</u>	<u>Field Name</u>	<u>Description</u>
1	Entity Type Number	422
2	Parameter Data	Pointer to corresponding PD record, see Note 1
3	Structure	Negative pointer to attribute definition, see Note 6
4	Line Font Pattern	0 or blank
5	Level	0 or blank
6	View	0 or blank
7	Transformation Matrix	0 or blank
8	Label Pointer	0 or blank
9A	Blank Status	00
9B	Subordinate Switch	00
9C	Entity Use	03
9D	Hierarchy	00
10	Sequence Number	DE line number, see Note 2
11	Entity Type Number	422
12	Line Weight	0 or blank
13	Color Number	0 or blank
14	Parameter Line Count	Number of lines in PD record, see Note 3
15	Form Number	0
16	Reserved	Blank
17	Reserved	Blank
18	Entity Label	Optional, see Note 7
19	Entity Subscript No.	Optional, see Note 8
20	Sequence Number	DE line number, see Note 4

Parameter Data

<u>Index</u>	<u>Description</u>
1	Piping object type value (AT = 17, ALT = 4)
2	Piping system identifier value (AT = 19, ALT = 4)
.	.
.	.
.	.
N	Last attribute value
N+1	Number of associativity instance pointers (= 0 or blank)
N+2	Number of property pointers (= 0 or blank)

4.2.1.4 Piping System Attributes Definition (Entity 322, Form 0)

Directory Entry

<u>Field #</u>	<u>Field Name</u>	<u>Description</u>
1	Entity Type Number	322
2	Parameter Data	Pointer to corresponding PD record, see Note 1
3	Structure	0 or blank
4	Line Font Pattern	0 or blank
5	Level	0 or blank
6	View	0 or blank
7	Transformation Matrix	0 or blank
8	Label Pointer	0 or blank
9A	Blank Status	00
9B	Subordinate Switch	00
9C	Entity Use	02
9D	Hierarchy	00
10	Sequence Number	DE line number, see Note 2
11	Entity Type Number	322
12	Line Weight	0 or blank
13	Color Number	0 or blank
14	Parameter Line Count	Number of lines in PD record, see Note 3
15	Form Number	0
16	Reserved	Blank
17	Reserved	Blank
18	Entity Label	Optional, see Note 7
19	Entity Subscript No.	Optional, see Note 8
20	Sequence Number	DE line number, see Note 4

Parameter Data

<u>Index</u>	<u>Description</u>
1	Attribute table name (= 13HPIPING SYSTEM)
2	Attribute list type (= 4)
3	Number of attributes in table (= N)
4	First attribute type (= 17)
5	First attribute value data type (= 3)
6	First attribute value count (= 1)
7	Second attribute type (= 19)
8	Second attribute value data type (= 3)
9	Second attribute value count (= 1)
.	.
.	.
.	.
N*3+1	Last attribute type
N*3+2	Last attribute value data type
N*3+3	Last attribute value count (AVC(N) = 1)
N*3+4	Number of associativity instance pointers (= 0 or blank)
N*3+5	Number of property pointers (= 0 or blank)

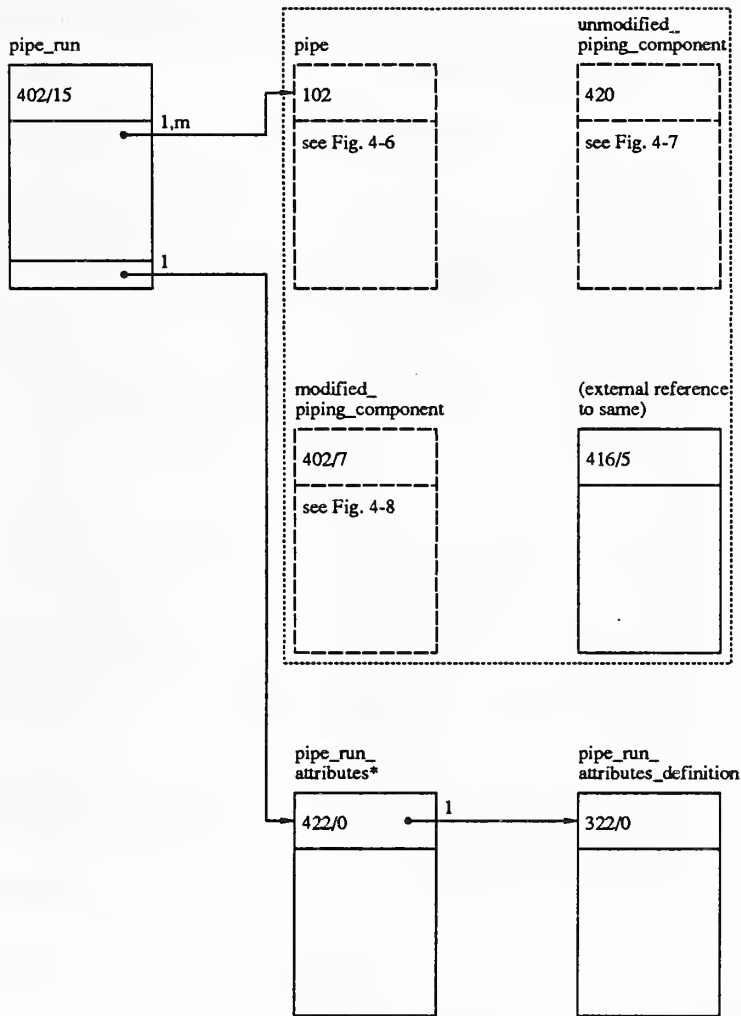

*Note:
 pipe_run_attributes are:
 piping_object_type
 pipe_run_identifier
 pipe_specification

4.2.2 Pipe Run

4.2.2.1 Pipe Run Group Associativity (Entity 402, Form 15)

Directory Entry

<u>Field #</u>	<u>Field Name</u>	<u>Description</u>
1	Entity Type Number	402
2	Parameter Data	Pointer to corresponding PD record, see Note 1
3	Structure	0 or blank
4	Line Font Pattern	0 or blank
5	Level	0 or blank
6	View	0 or blank
7	Transformation Matrix	0 or blank
8	Label Pointer	0 or blank
9A	Blank Status	00
9B	Subordinate Switch	00
9C	Entity Use	03
9D	Hierarchy	00
10	Sequence Number	DE line number, see Note 2
11	Entity Type Number	402
12	Line Weight	0 or blank
13	Color Number	0 or blank
14	Parameter Line Count	Number of lines in PD record, see Note 3
15	Form Number	15
16	Reserved	Blank
17	Reserved	Blank
18	Entity Label	Optional, see Note 7
19	Entity Subscript No.	Optional, see Note 8
20	Sequence Number	DE line number, see Note 4

Parameter Data

<u>Index</u>	<u>Description</u>
1	Number of entity pointers (= N, where $N \geq 1$)
2	Pointer to one of the following: - pipe composite curve (Entity 102) - unmodified piping component network subfigure instance (Entity 420) - modified piping component group associativity (Entity 402/7) - external reference (Entity 416/5)
.	.
.	.
.	.
N+1	Pointer to one of the following: - pipe composite curve (Entity 102) - unmodified piping component network subfigure instance (Entity 420) - modified piping component group associativity (Entity 402/7) - external reference (Entity 416/5)
N+2	Number of associativity instance pointers (= 0 or blank)
N+3	Number of property pointers (= 1)
N+4	Pointer to piping system attribute table instance (Entity 422/0)

4.2.2.2 External Reference (Entity 416, Form 5)

Directory Entry

<u>Field #</u>	<u>Field Name</u>	<u>Description</u>
1	Entity Type Number	416
2	Parameter Data	Pointer to corresponding PD record, see Note 1
3	Structure	0 or blank
4	Line Font Pattern	0 or blank
5	Level	0 or blank
6	View	Blank
7	Transformation Matrix	0 or blank
8	Label Pointer	0 or blank
9A	Blank Status	00
9B	Subordinate Switch	00
9C	Entity Use	04
9D	Hierarchy	00
10	Sequence Number	DE line number, see Note 2
11	Entity Type Number	416
12	Line Weight	0 or blank
13	Color Number	0 or blank
14	Parameter Line Count	Number of lines in PD record, see Note 3
15	Form Number	5
16	Reserved	Blank
17	Reserved	Blank
18	Entity Label	Optional, see Note 7
19	Entity Subscript No.	Optional, see Note 8
20	Sequence Number	DE line number, see Note 4

Parameter Data

<u>Index</u>	<u>Description</u>
1	External reference entity symbolic name - for pipe = pipe identifier - for unmodified piping component = piping component identifier - for modified piping component = piping component identifier
2	Number of associativity instance pointers (= 0 or blank)
3	Number of property pointers (= 0 or blank)

4.2.2.3 Pipe Run Attributes (Entity 422, Form 0)

Directory Entry

<u>Field #</u>	<u>Field Name</u>	<u>Description</u>
1	Entity Type Number	422
2	Parameter Data	Pointer to corresponding PD record, see Note 1
3	Structure	Negative pointer to attribute definition, see Note 6
4	Line Font Pattern	0 or blank
5	Level	0 or blank
6	View	0 or blank
7	Transformation Matrix	0 or blank
8	Label Pointer	0 or blank
9A	Blank Status	00
9B	Subordinate Switch	00
9C	Entity Use	03
9D	Hierarchy	00
10	Sequence Number	DE line number, see Note 2
11	Entity Type Number	422
12	Line Weight	0 or blank
13	Color Number	0 or blank
14	Parameter Line Count	Number of lines in PD record, see Note 3
15	Form Number	0
16	Reserved	Blank
17	Reserved	Blank
18	Entity Label	Optional, see Note 7
19	Entity Subscript No.	Optional, see Note 8
20	Sequence Number	DE line number, see Note 4

Parameter Data

<u>Index</u>	<u>Description</u>
1	Piping object type value (AT = 17, ALT = 4)
2	Pipe run identifier value (AT = 19, ALT = 4)
3	Pipe specification value (AT = 37, ALT = 4)
.	.
.	.
.	.
N	Last attribute value
N+1	Number of associativity instance pointers (= 0 or blank)
N+2	Number of property pointers (= 0 or blank)

4.2.2.4 Pipe Run Attributes Definition (Entity 322, Form 0)

Directory Entry

<u>Field #</u>	<u>Field Name</u>	<u>Description</u>
1	Entity Type Number	322
2	Parameter Data	Pointer to corresponding PD record, see Note 1
3	Structure	0 or blank
4	Line Font Pattern	0 or blank
5	Level	0 or blank
6	View	0 or blank
7	Transformation Matrix	0 or blank
8	Label Pointer	0 or blank
9A	Blank Status	00
9B	Subordinate Switch	00
9C	Entity Use	02
9D	Hierarchy	00
10	Sequence Number	DE line number, see Note 2
11	Entity Type Number	322
12	Line Weight	0 or blank
13	Color Number	0 or blank
14	Parameter Line Count	Number of lines in PD record, see Note 3
15	Form Number	0
16	Reserved	Blank
17	Reserved	Blank
18	Entity Label	Optional, see Note 7
19	Entity Subscript No.	Optional, see Note 8
20	Sequence Number	DE line number, see Note 4

Parameter Data

<u>Index</u>	<u>Description</u>
1	Attribute table name (= 8HPIPE RUN)
2	Attribute list type (= 4)
3	Number of attributes in table (= N)
4	First attribute type (= 17)
5	First attribute value data type (= 3)
6	First attribute value count (= 1)
7	Second attribute type (= 19)
8	Second attribute value data type (= 3)
9	Second attribute value count (= 1)
10	Third attribute type (= 37)
11	Third attribute value data type (= 3)
12	Third attribute value count (= 1)
.	.
.	.
.	.
N*3+1	Last attribute type
N*3+2	Last attribute value data type
N*3+3	Last attribute value count (AVC(N) = 1)
N*3+4	Number of associativity instance pointers (= 0 or blank)
N*3+5	Number of property pointers (= 0 or blank)

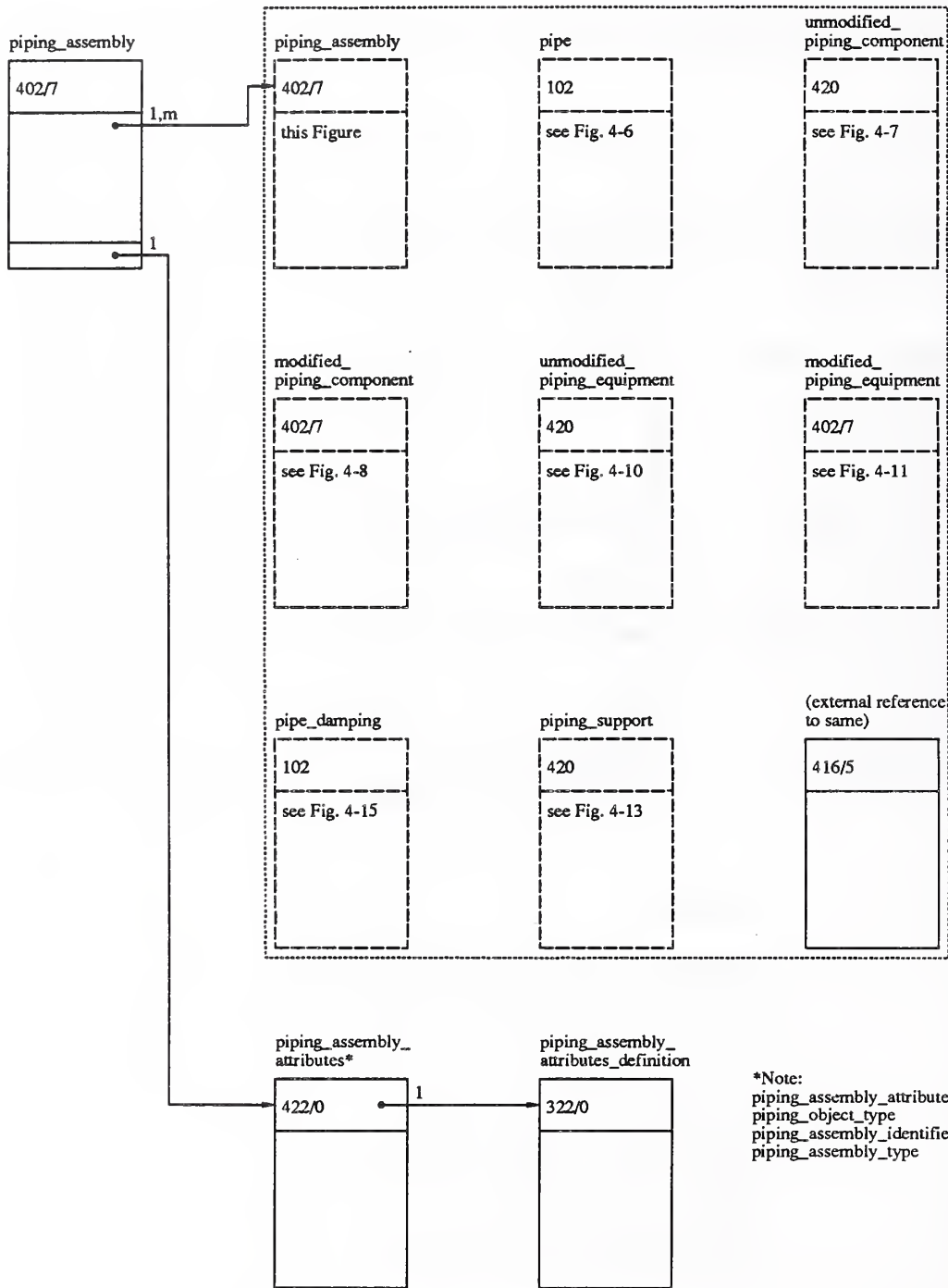

4.2.3 Piping Assembly

4.2.3.1 Piping Assembly Group Associativity (Entity 402, Form 7)

Directory Entry

<u>Field #</u>	<u>Field Name</u>	<u>Description</u>
1	Entity Type Number	402
2	Parameter Data	Pointer to corresponding PD record, see Note 1
3	Structure	0 or blank
4	Line Font Pattern	0 or blank
5	Level	0 or blank
6	View	0 or blank
7	Transformation Matrix	0 or blank
8	Label Pointer	0 or blank
9A	Blank Status	00
9B	Subordinate Switch	00
9C	Entity Use	03
9D	Hierarchy	00
10	Sequence Number	DE line number, see Note 2
11	Entity Type Number	402
12	Line Weight	0 or blank
13	Color Number	0 or blank
14	Parameter Line Count	Number of lines in PD record, see Note 3
15	Form Number	7
16	Reserved	Blank
17	Reserved	Blank
18	Entity Label	Optional, See Note 7
19	Entity Subscript No.	Optional, see Note 8
20	Sequence Number	DE line number, see Note 4

Parameter Data

<u>Index</u>	<u>Description</u>
1	Number of entity pointers (= N, where $N \geq 1$)
2	Pointer to one of the following: <ul style="list-style-type: none">- piping assembly group associativity (Entity 402/7)- pipe composite curve (Entity 102)- unmodified piping component network subfigure instance (Entity 420)- modified piping component group associativity (Entity 402/7)- unmodified piping equipment network subfigure instance (Entity 420)- modified piping equipment group associativity (Entity 402/7)- pipe damping composite curve (Entity 102)- piping support network subfigure instance (Entity 420)- external reference (Entity 416/5)
.	.
.	.
.	.
N+1	Pointer to one of the following: <ul style="list-style-type: none">- piping assembly group associativity (Entity 402/7)- pipe composite curve (Entity 102)- unmodified piping component network subfigure instance (Entity 420)- modified piping component group associativity (Entity 402/7)

- unmodified piping equipment network subfigure instance (Entity 420)
 - modified piping equipment group associativity (Entity 402/7)
 - pipe damping composite curve (Entity 102)
 - piping support network subfigure instance (Entity 420)
 - external reference (Entity 416/5)
- N+2 Number of associativity instance pointers (= 0)
- N+3 Number of property pointers (= 1)
- N+4 Pointer to group attribute table instance (Entity 422/0)

4.2.3.2 External Reference (Entity 416, Form 5)

Directory Entry

<u>Field #</u>	<u>Field Name</u>	<u>Description</u>
1	Entity Type Number	416
2	Parameter Data	Pointer to corresponding PD record, see Note 1
3	Structure	0 or blank
4	Line Font Pattern	0 or blank
5	Level	0 or blank
6	View	0 or blank
7	Transformation Matrix	0 or blank
8	Label Pointer	0 or blank
9A	Blank Status	00
9B	Subordinate Switch	00
9C	Entity Use	04
9D	Hierarchy	00
10	Sequence Number	DE line number, see Note 2
11	Entity Type Number	416
12	Line Weight	0 or blank
13	Color Number	0 or blank
14	Parameter Line Count	Number of lines in PD record, see Note 3
15	Form Number	5
16	Reserved	Blank
17	Reserved	Blank
18	Entity Label	Optional, see Note 7
19	Entity Subscript No.	Optional, see Note 8
20	Sequence Number	DE line number, see Note 4

Parameter Data

<u>Index</u>	<u>Description</u>
1	External reference entity symbolic name - for piping assembly = piping assembly identifier - for pipe = pipe identifier - for unmodified piping component = piping component identifier - for modified piping component = piping component identifier - for unmodified piping equipment = piping equipment identifier - for modified piping equipment = piping equipment identifier - for pipe damping = pipe damping identifier - for piping support = piping support identifier
2	Number of associativity instance points (= 0 or blank)
3	Number of property pointers (= 0 or blank)

4.2.3.3 Piping Assembly Attributes (Entity 422, Form 0)

Directory Entry

<u>Field#</u>	<u>Field Name</u>	<u>Description</u>
1	Entity Type Number	422
2	Parameter Data	Pointer to corresponding PD record, see Note 1
3	Structure	Negative pointer to attribute definition, see Note 6
4	Line Font Pattern	0 or blank
5	Level	0 or blank
6	View	0 or blank
7	Transformation Matrix	0 or blank
8	Label Pointer	0 or blank
9A	Blank Status	00
9B	Subordinate Switch	00
9C	Entity Use	03
9D	Hierarchy	00
10	Sequence Numb	DE line number, see Note 2
11	Entity Type Number	422
12	Line Weight	0 or blank
13	Color Number	0 or blank
14	Parameter Line Count	Number of lines in PD record, see Note 3
15	Form Number	0
16	Reserved	Blank
17	Reserved	Blank
18	Entity Label	Optional, see Note 7
19	Entity Subscript No.	Optional, see Note 8
20	Sequence Number	DE line number, see Note 4

Parameter Data

<u>Index</u>	<u>Description</u>
1	Piping object type value (AT = 17, ALT = 4)
2	Piping assembly identifier value (AT = 19, ALT = 4)
3	Piping assembly type value (AT = 38, ALT = 4)
.	.
.	.
.	.
N	Last attribute value
N+1	Number of associativity instance pointers (= 0 or blank)
N+2	Number of property pointers (= 0 or blank)

4.2.3.4 Piping Assembly Attributes Definition (Entity 322, Form 0)

Directory Entry

<u>Field #</u>	<u>Field Name</u>	<u>Description</u>
1	Entity Type Number	322
2	Parameter Data	Pointer to corresponding PD record, see Note 1
3	Structure	0 or blank
4	Line Font Pattern	0 or blank
5	Level	0 or blank
6	View	0 or blank
7	Transformation Matrix	0 or blank
8	Label Pointer	0 or blank
9A	Blank Status	00
9B	Subordinate Switch	00
9C	Entity Use	02
9D	Hierarchy	00
10	Sequence Number	DE line number, see Note 2
11	Entity Type Number	322
12	Line Weight	0 or blank
13	Color Number	0 or blank
14	Parameter Line Count	Number of lines in PD record, see Note 3
15	Form Number	0
16	Reserved	Blank
17	Reserved	Blank
18	Entity Label	Optional, see Note 7
19	Entity Subscript No.	Optional, see Note 8
20	Sequence Number	DE line number, see Note 4

Parameter Data

<u>Index</u>	<u>Description</u>
1	Attribute table name (= 15HPIPING ASSEMBLY)
2	Attribute list type (= 4)
3	Number of attributes in table (= N)
4	First attribute type (= 17)
5	First attribute value data type (= 3)
6	First attribute value count (= 1)
7	Second attribute type (= 19)
8	Second attribute value data type (= 3)
9	Second attribute value count (= 1)
10	Third attribute type (= 38)
11	Third attribute value data type (= 3)
12	Third attribute value count (= 1)
.	.
.	.
.	.
N*3+1	Last attribute type
N*3+2	Last attribute value data type
N*3+3	Last attribute value count (AVC(N) = 1)
N*3+4	Number of associativity instance pointers (= 0 or blank)
N*3+5	Number of property pointers (= 0 or blank)

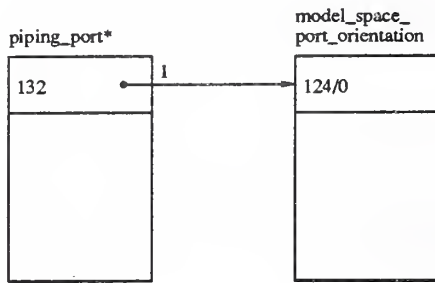

*Note:
 piping_port is one of:
 pipe_branch_port
 pipe_end_port
 piping_component_port
 added_piping_component_port
 piping_equipment_port

piping_port contains model_space_location and the attributes:
 port_type
 port_label

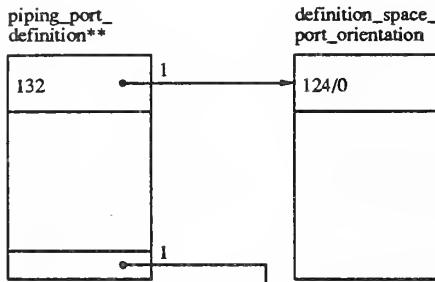

**Note:
 piping_port_definition is one of:
 piping_component_port_definition
 piping_equipment_port_definition

piping_port_definition contains definition_space_location and the attributes:
 port_definition_type
 port_definition_label

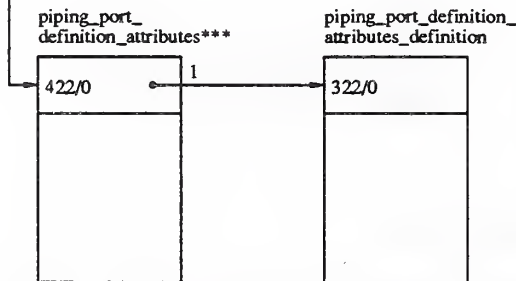

***Note:
 piping_port_definition_attributes are:
 end_preparation
 pressure_rating
 pressure_rating_units
 pipe_fit_up_length
 pipe_fit_up_length_units

4.2.4 Piping Port and Piping Port Definition

4.2.4.1 Piping Port Connect Point (Entity 132)

Directory Entry

<u>Field #</u>	<u>Field Name</u>	<u>Description</u>
1	Entity Type Number	132
2	Parameter Data	Pointer to corresponding PD record, see Note 1
3	Structure	0 or blank
4	Line Font Pattern	0 or blank
5	Level	0 or blank
6	View	0 or blank
7	Transformation Matrix	Pointer to tranformation matrix, see Note 5
8	Label Pointer	0 or blank
9A	Blank Status	00
9B	Subordinate Switch	02
9C	Entity Use	04
9D	Hierarchy	00
10	Sequence Number	DE line number, see Note 2
11	Entity Type Number	132
12	Line Weight	0 or blank
13	Color Number	0 or blank
14	Parameter Line Count	Number of lines in PD record, see Note 3
15	Form Number	0
16	Reserved	Blank
17	Reserved	Blank
18	Entity Label	Optional, see Note 7
19	Entity Subscript No.	Optional, see Note 8
20	Sequence Number	DE line number, see Note 4

Parameter Data

<u>Index</u>	<u>Description</u>
1	X coordinate in model space location
2	Y coordinate in model space location
3	Z coordinate in model space location
4	Pointer to the display symbol geometry (= 0 or blank)
5	Type flag (= 2)
6	Function flag (= 2)
7	Port label
8	Pointer to text display (= 0 or blank)
9	Port type
10	Pointer to text display (= 0 or blank)
11	Unique connect point identifier (= 0 or blank)
12	Connect point function code (= 0 or blank)
13	Swap flag (= 0 or blank)
14	Pointer to NSI, NSD (= 0 or blank)
15	Number of associativity instance pointers (= 0 or blank)
16	Number of property pointers (= 0 or blank)

4.2.4.2 Model Space Port Orientation (Entity 124, Form 0)

Directory Entry

<u>Field #</u>	<u>Field Name</u>	<u>Description</u>
1	Entity Type Number	124
2	Parameter Data	Pointer to corresponding PD record, see Note 1
3	Structure	0 or blank
4	Line Font Pattern	0 or blank
5	Level	0 or blank
6	View	0 or blank
7	Transformation Matrix	0 or blank
8	Label Pointer	0 or blank
9A	Blank Status	00
9B	Subordinate Switch	00
9C	Entity Use	00
9D	Hierarchy	00
10	Sequence Number	DE line number, see Note 2
11	Entity Type Number	124
12	Line Weight	0 or blank
13	Color Number	0 or blank
14	Parameter Line Count	Number of lines in PD record, see Note 3
15	Form Number	0 or 1
16	Reserved	Blank
17	Reserved	Blank
18	Entity Label	Optional, see Note 7
19	Entity Subscript No.	Optional, see Note 8
20	Sequence Number	DE line number, see Note 4

Parameter Data

<u>Index</u>	<u>Description</u>
1-3	First row of rotation matrix which provides piping port orientation in model space
4	X translation (= 0 or blank)
5-7	Second row of rotation matrix which provides piping port orientation in model space
8	Y translation (= 0 or blank)
9-11	Third row of rotation matrix which provides piping port orientation in model space
12	Z translation (= 0 or blank)
13	Number of associativity instance pointers (= 0 or blank)
14	Number of property pointers (= 0 or blank)

4.2.4.3 Piping Port Definition Connect Point (Entity 132)

Directory Entry

<u>Field#</u>	<u>Field Name</u>	<u>Description</u>
1	Entity Type Number	132
2	Parameter Data	Pointer to corresponding PD record, see Note 1
3	Structure	0 or blank
4	Line Font Pattern	0 or blank
5	Level	0 or blank
6	View	0 or blank
7	Transformation Matrix	Pointer to transformation matrix, see Note 5
8	Label Pointer	0 or blank
9A	Blank Status	00
9B	Subordinate Switch	02
9C	Entity Use	04
9D	Hierarchy	00
10	Sequence Number	DE line number, see Note 2
11	Entity Type Number	132
12	Line Weight	0 or blank
13	Color Number	0 or blank
14	Parameter Line Count	Number of lines in PD record, see Note 3
15	Form Number	0
16	Reserved	Blank
17	Reserved	Blank
18	Entity Label	Optional, see Note 7
19	Entity Subscript No.	Optional, see Note 8
20	Sequence Number	DE line number, see Note 4

Parameter Data

<u>Index</u>	<u>Description</u>
1	X coordinate in model space location
2	Y coordinate in model space location
3	Z coordinate in model space location
4	Pointer to the display symbol geometry (= 0 or blank)
5	Type flag (= 2)
6	Function flag (= 2)
7	Port definition label
8	Pointer to text display (= 0 or blank)
9	Port definition type (= 25HCOMPONENT PORT DEFINITION or 25HEQUIPMENT PORT DEFINITION)
10	Pointer to text display (= 0 or blank)
11	Unique connect point identifier (= 0 or blank)
12	Connect point function code (= 0 or blank)
13	Swap flag (= 0 or blank)
14	Pointer to NSI, NSD (= 0 or blank)
15	Number of associativity instance pointers (= 0 or blank)
16	Number of property pointers (= 1)
17	Pointer to piping port definition attribute table instance (Entity 422/0)

4.2.4.4 Definition Space Port Orientation (Entity 124, Form 0)

Directory Entry

<u>Field #</u>	<u>Field Name</u>	<u>Description</u>
1	Entity Type Number	124
2	Parameter Data	Pointer to corresponding PD record, see Note 1
3	Structure	0 or blank
4	Line Font Pattern	0 or blank
5	Level	0 or blank
6	View	0 or blank
7	Transformation Matrix	0 or blank
8	Label Pointer	0 or blank
9A	Blank Status	00
9B	Subordinate Switch	00
9C	Entity Use	00
9D	Hierarchy	00
10	Sequence Number	DE line number, see Note 2
11	Entity Type Number	124
12	Line Weight	0 or blank
13	Color Number	0 or blank
14	Parameter Line Count	Number of lines in PD record, see Note 3
15	Form Number	0 or 1
16	Reserved	Blank
17	Reserved	Blank
18	Entity Label	Optional, see Note 7
19	Entity Subscript No.	Optional, see Note 8
20	Sequence Number	DE line number, see Note 4

Parameter Data

<u>Index</u>	<u>Description</u>
1-3	First row of rotation matrix which provides piping port orientation in definition space
4	X translation (= 0 or blank)
5-7	Second row of rotation matrix which provides piping port orientation in definition space
8	Y translation (= 0 or blank)
9-11	Third row of rotation matrix which provides piping port orientation in definition space
12	Z translation (= 0 or blank)
13	Number of associativity instance pointers (= 0 or blank)
14	Number of property pointers (= 0 or blank)

4.2.4.5 Piping Port Definition Attributes (Entity 422, Form 0)

Directory Entry

<u>Field #</u>	<u>Field Name</u>	<u>Description</u>
1	Entity Type Number	422
2	Parameter Data	Pointer to corresponding PD record, see Note 1
3	Structure	Negative pointer to attribute definition, see Note 6
4	Line Font Pattern	0 or blank
5	Level	0 or blank
6	View	0 or blank
7	Transformation Matrix	0 or blank
8	Label Pointer	0 or blank
9A	Blank Status	00
9B	Subordinate Switch	00
9C	Entity Use	03
9D	Hierarchy	00
10	Sequence Number	DE line number, see Note 2
11	Entity Type Number	422
12	Line Weight	0 or blank
13	Color Number	0 or blank
14	Parameter Line Count	Number of lines in PD record, see Note 3
15	Form Number	0
16	Reserved	Blank
17	Reserved	Blank
18	Entity Label	Optional, see Note 7
19	Entity Subscript No.	Optional, see Note 8
20	Sequence Number	DE line number, see Note 4

Parameter Data

<u>Index</u>	<u>Description</u>
1	End preparation (AT = 3, ALT = 4)
2	Pressure rating value (AT = 85, ALT = 4)
3	Pressure rating units value (AT = 86, ALT = 4)
4	Pipe fit up length (AT = 139, ALT = 4)
5	Pipe fit up length units (AT = 140, ALT = 4)
.	.
.	.
.	.
N	Last attribute value
N+1	Number of associativity instance pointers (= 0 or blank)
N+2	Number of property pointers (= 0 or blank)

4.2.4.6 Piping Port Definition Attributes Definition (Entity 322, Form 0)

Directory Entry

<u>Field #</u>	<u>Field Name</u>	<u>Description</u>
1	Entity Type Number	322
2	Parameter Data	Pointer to corresponding PD record, see Note 1
3	Structure	0 or blank
4	Line Font Pattern	0 or blank
5	Level	0 or blank
6	View	0 or blank
7	Transformation Matrix	0 or blank
8	Label Pointer	0 or blank
9A	Blank Status	00
9B	Subordinate Switch	00
9C	Entity Use	02
9D	Hierarchy	00
10	Sequence Number	DE line number, see Note 2
11	Entity Type Number	322
12	Line Weight	0 or blank
13	Color Number	0 or blank
14	Parameter Line Count	Number of lines in PD record, see Note 3
15	Form Number	0
16	Reserved	Blank
17	Reserved	Blank
18	Entity Label	Optional, see Note 7
19	Entity Subscript No.	Optional, see Note 8
20	Sequence Number	DE line number, see Note 4

Parameter Data

<u>Index</u>	<u>Description</u>
1	Attribute table name (= 22HPIPING PORT DEFINITION)
2	Attribute list type (= 4)
3	Number of attributes in table (= N)
4	First attribute type (= 3)
5	First attribute value data type (= 3)
6	First attribute value count (= 1)
7	Second attribute type (= 85)
8	Second attribute value data type (= 2)
9	Second attribute value count (= 1)
10	Third attribute type (= 86)
11	Third attribute value data type (= 3)
12	Third attribute value count (= 1)
13	Fourth attribute type (= 139)
14	Fourth attribute value data type (= 2)
15	Fourth attribute value count (= 1)
16	Fifth attribute type (= 140)
17	Fifth attribute value data type (= 3)
18	Fifth attribute value count (= 1)
.	.
.	.
.	.

N*3+1	Last attribute type
N*3+2	Last attribute value data type
N*3+3	Last attribute value count (AVC(N) = 1)
N*3+4	Number of associativity instance pointers (= 0 or blank)
N*3+5	Number of property pointers (= 0 or blank)

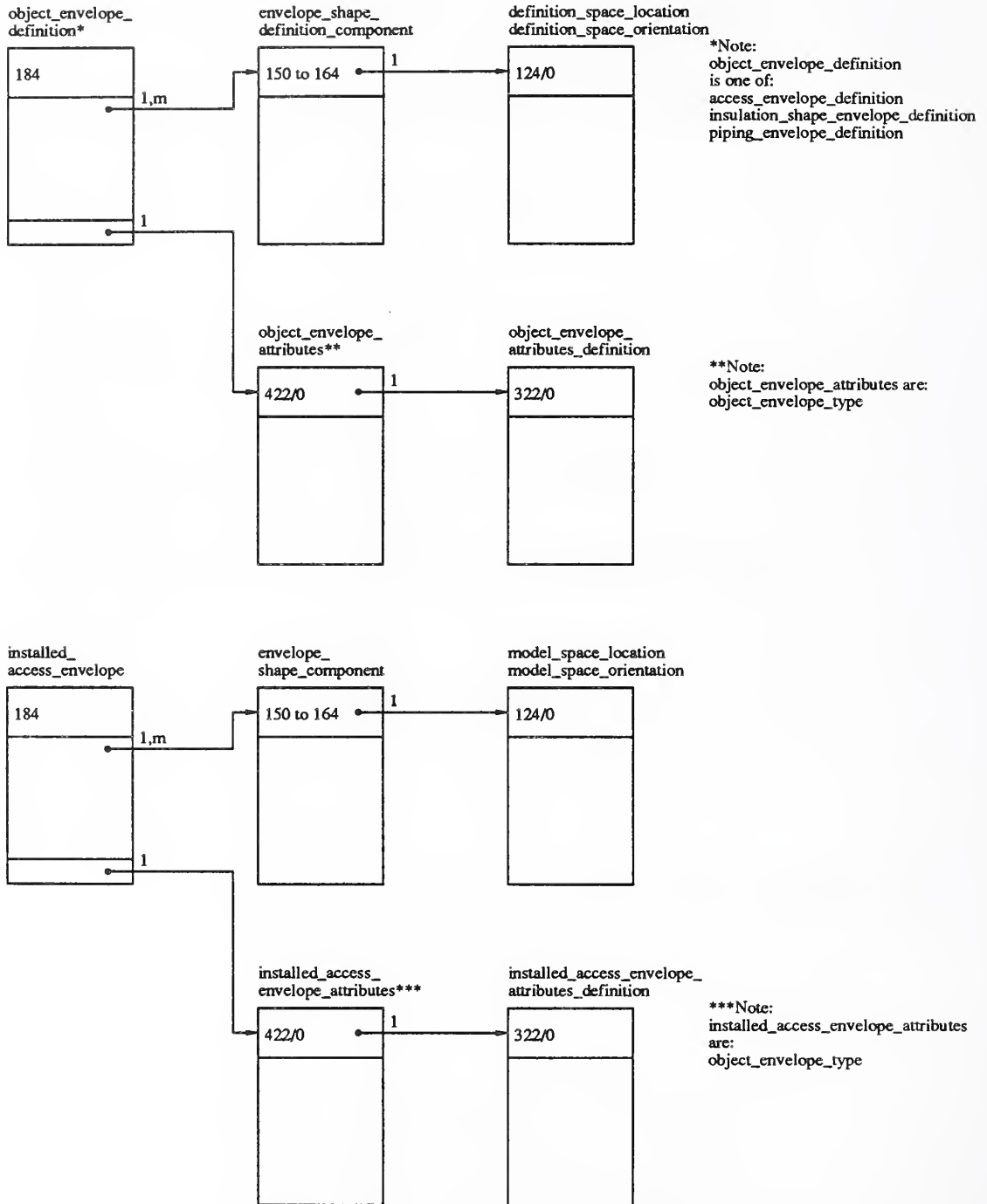

4.2.5 Object Envelope Definition and Installed Access Envelope

4.2.5.1 Object Envelope Definition Solid Assembly (Entity 184)

Directory Entry

<u>Field #</u>	<u>Field Name</u>	<u>Description</u>
1	Entity Type Number	184
2	Parameter Data	Pointer to corresponding PD record, see Note 1
3	Structure	0 or blank
4	Line Font Pattern	0 or blank
5	Level	0 or blank
6	View	0 or blank
7	Transformation Matrix	0 or blank
8	Label Pointer	0 or blank
9A	Blank Status	00
9B	Subordinate Switch	00
9C	Entity Use	02
9D	Hierarchy	00
10	Sequence Number	DE line number, see Note 2
11	Entity Type Number	184
12	Line Weight	0 or blank
13	Color Number	0 or blank
14	Parameter Line Count	Number of lines in PD record, see Note 3
15	Form Number	0 or blank
16	Reserved	Blank
17	Reserved	Blank
18	Entity Label	Optional, see Note 7
19	Entity Subscript No.	Optional, see Note 8
20	Sequence Number	DE line number, see Note 4

Parameter Data

<u>Index</u>	<u>Description</u>
1	Number of object envelope shape definition components
2	Pointer to item 1, one of the following envelope shape definition components: <ul style="list-style-type: none">- Block (Entity 150)- Right Angular Wedge (Entity 152)- Right Circular Cylinder (Entity 154)- Right Circular Cone Frustum (Entity 156)- Sphere (Entity 158)- Torus (Entity 160)- Solid of Revolution (Entity 162)- Solid of Linear Extrusion (Entity 164)
.	.
.	.
.	.
N+1	Pointer to item N
N+2	Pointer to Transformation Matrix for item 1
2N+1	Pointer to Transformation Matrix of item N
2N+2	Number of associativity instance pointers (= 0 or blank)

2N+3
2N+4

Number of property pointers (= 1)
Pointer to object envelope attribute table instance (Entity 422/0)

4.2.5.2 Envelope Shape Definition Block (Entity 150)

Directory Entry (applies to Entities 150, 152, 154, 156, 158, 160, 162, and 164)

<u>Field #</u>	<u>Field Name</u>	<u>Description</u>
1	Entity Type Number	150, 152, 154, 156, 158, 160, 162, 164
2	Parameter Data	Pointer to corresponding PD record, see Note 1
3	Structure	0 or blank
4	Line Font Pattern	0 or blank
5	Level	0 or blank
6	View	0 or blank
7	Transformation Matrix	Pointer to tranformation matrix, see Note 5
8	Label Pointer	0 or blank
9A	Blank Status	00
9B	Subordinate Switch	01
9C	Entity Use	00
9D	Hierarchy	00
10	Sequence Number	DE line number, see Note 2
11	Entity Type Number	150, 152, 154, 156, 158, 160, 162, 164
12	Line Weight	0 or blank
13	Color Number	0 or blank
14	Parameter Line Count	Number of lines in PD record, see Note 3
15	Form Number	0 or 1
16	Reserved	Blank
17	Reserved	Blank
18	Entity Label	Optional, see Note 7
19	Entity Subscript No.	Optional, see Note 8
20	Sequence Number	DE line number, see Note 4

Parameter Data

<u>Index</u>	<u>Description</u>
1	Length in the local X direction
2	Length in the local Y direction
3	Length in the local Z direction
4	X corner coordinate
5	Y corner coordinate
6	Z corner coordinate
7	I X-axis unit vector
8	J X-axis unit vector
9	K X-axis unit vector
10	I Z-axis unit vector must be orthogonal to X-axis
11	J Z-axis unit vector must be orthogonal to X-axis
12	K Z-axis unit vector must be orthogonal to X-axis
13	Number of associativity instance pointers (= 0 or blank)
14	Number of property pointers (= 0 or blank)

4.2.5.3 Envelope Shape Definition Right Angular Wedge (Entity 152)

Directory Entry

Same requirements as listed for the Directory Entry of Envelope Shape Definition Block (Entity 150), refer to Section 4.2.5.2.

Parameter Data

<u>Index</u>	<u>Description</u>
1	Length in local X direction at $Y = 0$
2	Length in local Y direction
3	Length in local Z direction
4	Length in local X direction at distance (index 2) from local X-axis
5	X corner coordinate
6	Y corner coordinate
7	Z corner coordinate
8	I X-axis unit vector
9	J X-axis unit vector
10	K X-axis unit vector
11	I Z-axis unit vector must be orthogonal to X-axis
12	J Z-axis unit vector must be orthogonal to X-axis
13	K Z-axis unit vector must be orthogonal to X-axis
14	Number of associative instances pointer (= 0 or blank)
15	Number of property pointers (= 0 or blank)

4.2.5.4 Envelope Shape Definition Right Circular Cylinder (Entity 154)

Directory Entry

Same requirements as listed for the Directory Entry of Envelope Shape Definition Block (Entity 150), refer to Section 4.2.5.2.

Parameter Data

<u>Index</u>	<u>Description</u>
1	Cylinder height
2	Cylinder radius
3	X coordinate of first face center
4	Y coordinate of first face center
5	Z coordinate of first face center
6	I unit vector in axis direction
7	J unit vector in axis direction
8	K unit vector in axis direction
9	Number of associativity instance pointers (= 0 or blank)
10	Number of property pointers (= 0 or blank)

4.2.5.5 Envelope Shape Definition Right Circular Cone Frustum (Entity 156)

Directory Entry

Same requirements as listed for the Directory Entry of Envelope Shape Definition Block (Entity 150), refer to Section 4.2.5.2.

Parameter Data

<u>Index</u>	<u>Description</u>
1	Height
2	Larger face radius
3	Smaller face radius(zero for cone apex -default)
4	Larger face center X coordinates
5	Larger face center Y coordinates
6	Larger face center Z coordinates
7	I unit vector in axis direction
8	J unit vector in axis direction
9	K unit vector in axis direction
10	Number of associative instance pointers (= 0 or blank)
11	Number of property pointers (= 0 or blank)

4.2.5.6 Envelope Shape Definition Sphere (Entity 158)

Directory Entry

Same requirements as listed for the Directory Entry of Envelope Shape Definition Block (Entity 150), refer to Section 4.2.5.2.

Parameter Data

<u>Index</u>	<u>Description</u>
1	Radius
2	Center X coordinate
3	Center Y coordinate
4	Center Z coordinate
5	Number of associativity instance pointers (= 0 or blank)
6	Number of property pointers (= 0 or blank)

4.2.5.7 Envelope Shape Definition Torus (Entity 160)

Directory Entry

Same requirements as listed for the Directory Entry of Envelope Shape Definition Block (Entity 150), refer to Section 4.2.5.2.

Parameter Data

<u>Index</u>	<u>Description</u>
1	Distance from center of torus to center of circular disc to be revolved (perpendicular to axis)
2	Radius of circular disc
3	Torus center X coordinate
4	Torus center Y coordinate
5	Torus center Z coordinate
6	I unit vector in axis direction
7	J unit vector in axis direction
8	K unit vector in axis direction
9	Number of associativity instance pointers (= 0 or blank)
10	Number of associativity property pointers (= 0 or blank)

4.2.5.8 Envelope Shape Definition Solid of Revolution (Entity 162)

Directory Entry

Same requirements as listed for the Directory Entry of Envelope Shape Definition Block (Entity 150), refer to Section 4.2.5.2.

Parameter Data

<u>Index</u>	<u>Description</u>
1	DE sequence number of curve entity to be revolved. Must be coplanar with rotation axis.
2	Fraction of full rotation through which the curve entity will be revolved.
3	X coordinate of point on axis
4	Y coordinate of point on axis
5	Z coordinate of point on axis
6	I unit vector in axis direction
7	J unit vector in axis direction
8	K unit vector in axis direction

4.2.5.9 Envelope Shape Definition Solid of Linear Extrusion (Entity 164)

Directory Entry

Same requirements as listed for the Directory Entry of Envelope Shape Definition Block (Entity 150), refer to Section 4.2.5.2.

Parameter Data

<u>Index</u>	<u>Description</u>
1	Pointer to closed curve entity
2	Length of extrusion along vector positive direction
3	I unit vector specifying direction of extrusion
4	J unit vector specifying direction of extrusion
5	K unit vector specifying direction of extrusion

4.2.5.10 Object Envelope Definition Space Location and Orientation (Entity 124, Form 0)

Directory Entry

<u>Field</u>	<u>Field Name</u>	<u>Description</u>
1	Entity Type Number	124
2	Parameter Data	Pointer to corresponding PD record, see Note 1
3	Structure	0 or blank
4	Line Font Pattern	0 or blank
5	Level	0 or blank
6	View	0 or blank
7	Transformation Matrix	0 or blank
8	Label Pointer	0 or blank
9A	Blank Status	00
9B	Subordinate Switch	00
9C	Entity Use	00
9D	Hierarchy	00
10	Sequence Number	DE line number, see Note 2
11	Entity Type Number	124
12	Line Weight	0 or blank
13	Color Number	0 or blank
14	Parameter Line Count	Number of lines in PD record, see Note 3
15	Form Number	0 or 1
16	Reserved	Blank
17	Reserved	Blank
18	Entity Label	Optional, see Note 7
19	Entity Subscript No.	Optional, see Note 8
20	Sequence Number	DE line number, see Note 4

Parameter Data

<u>Index</u>	<u>Description</u>
1-3	First row of rotation matrix which defines object envelope orientation in definition space
4	X coordinate of object envelope location in definition space
5-7	Second row of rotation matrix which defines object envelope orientation in definition space
8	Y coordinate of object envelope location in definition space
9-11	Third row of rotation matrix which defines object envelope orientation in definition space
12	Z coordinate of object envelope location in definition space
13	Number of associativity instance pointers (= 0 or blank)
14	Number of property pointers (= 0 or blank)

4.2.5.11 Object Envelope Attributes (Entity 422, Form 0)

Directory Entry

<u>Field #</u>	<u>Field Name</u>	<u>Description</u>
1	Entity Type Number	422
2	Parameter Data	Pointer to corresponding PD record, see Note 1
3	Structure	Negative pointer to attribute definition, see Note 6
4	Line Font Pattern	0 or blank
5	Level	0 or blank
6	View	0 or blank
7	Transformation Matrix	0 or blank
8	Label Pointer	0 or blank
9A	Blank Status	00
9B	Subordinate Switch	00
9C	Entity Use	03
9D	Hierarchy	00
10	Sequence Number	DE line number, see Note 2
11	Entity Type Number	422
12	Line Weight	0 or blank
13	Color Number	0 or blank
14	Parameter Line Count	Number of lines in PD record, see Note 3
15	Form Number	0
16	Reserved	Blank
17	Reserved	Blank
18	Entity Label	Optional, see Note 7
19	Entity Subscript No.	Optional, see Note 8
20	Sequence Number	DE line number, see Note 4

Parameter Data

<u>Index</u>	<u>Description</u>
1	Object envelope type value (AT = 17, ALT = 4)
.	.
.	.
.	.
N	Last attribute value
N+1	Number of associativity instance pointers (= 0 or blank)
N+2	Number of property pointers (= 0 or blank)

4.2.5.12 Object Envelope Attributes Definition (Entity 322, Form 0)

Directory Entry

<u>Field #</u>	<u>Field Name</u>	<u>Description</u>
1	Entity Type Number	322
2	Parameter Data	Pointer to corresponding PD record, see Note 1
3	Structure	0 or blank
4	Line Font Pattern	0 or blank
5	Level	0 or blank
6	View	0 or blank
7	Transformation Matrix	0 or blank
8	Label Pointer	0 or blank
9A	Blank Status	00
9B	Subordinate Switch	00
9C	Entity Use	02
9D	Hierarchy	00
10	Sequence Number	DE line number, see Note 2
11	Entity Type Number	322
12	Line Weight	0 or blank
13	Color Number	0 or blank
14	Parameter Line Count	Number of lines in PD record, see Note 3
15	Form Number	0
16	Reserved	Blank
17	Reserved	Blank
18	Entity Label	Optional, see Note 7
19	Entity Subscript No.	Optional, see Note 8
20	Sequence Number	DE line number, see Note 4

Parameter Data

<u>Index</u>	<u>Description</u>
1	Attributeable name (= 15HOBJECT ENVELOPE)
2	Attribute list type (= 4)
3	Number of attributes in table (= N)
4	First attribute type (= 17)
5	First attribute value data type (= 3)
6	First attribute value count (= 1)
.	.
.	.
N*3+1	Last attribute type
N*3+2	Last attribute value data type
N*3+3	Last attribute value count (AVC(N) = 1)
N*3+4	Number of associativity instance pointers (= 0 or blank)
N*3+5	Number of property pointers (= 0 or blank)

4.2.5.13 Installed Access Envelope Solid Assembly (Entity 184)

Directory Entry

Same requirements as listed for the Directory Entry of Object Envelope Definition Solid Assembly (Entity 184), refer to Section 4.2.5.1.

Parameter Data

<u>Index</u>	<u>Description</u>
1	Number of installed access envelope shape components
2	Pointer to item 1, one of the following envelope shape components: - Block (Entity 150) - Right Angular Wedge (Entity 152) - Right Circular Cylinder (Entity 154) - Right Circular Cone Frustum (Entity 156) - Sphere (Entity 158) - Torus (Entity 160) - Solid of Revolution (Entity 162) - Solid of Linear Extrusion (Entity 164)
.	.
.	.
.	.
N+1	Pointer to item N
N+2	Pointer to Transformation Matrix for item 1
2N+1	Pointer to Transformation Matrix of item N
2N+2	Number of associativity instance pointers (= 0 or blank)
2N+3	Number of property pointers (= 1)
2N+4	Pointer to installed access envelope attribute table instance (Entity 422/0)

4.2.5.14 Envelope Shape Block (Entity 150)

Directory Entry and Parameter Data

Same requirements as listed for Envelope Shape Definition Block (Entity 150), refer to Section 4.2.5.2.

4.2.5.15 Envelope Shape Right Angular Wedge (Entity 152)

Directory Entry and Parameter Data

Same requirements as listed for Envelope Shape Definition Right Angular Wedge (Entity 152), refer to Section 4.2.5.3.

4.2.5.16 Envelope Shape Right Circular Cylinder (Entity 154)

Directory Entry and Parameter Data

Same requirements as listed for Envelope Shape Definition Right Circular Cylinder (Entity 154), refer to Section 4.2.5.4.

4.2.5.17 Envelope Shape Right Circular Cone Frustum (Entity 156)

Directory Entry and Parameter Data

Same requirements as listed for Envelope Shape Definition Right Circular Cone Frustum (Entity 156), refer to Section 4.2.5.5.

4.2.6.18 Envelope Shape Sphere (Entity 158)

Directory Entry and Parameter Data

Same requirements as listed for Envelope Shape Definition Sphere (Entity 158), refer to Section 4.2.5.6.

4.2.5.19 Envelope Shape Torus (Entity 160)

Directory Entry and Parameter Data

Same requirements as listed for Envelope Shape Definition Torus (Entity 160), refer to Section 4.2.5.7.

4.2.5.20 Envelope Shape Solid of Revolution (Entity 162)

Directory Entry and Parameter Data

Same requirements as listed for Envelope Shape Definition Solid of Revolution (Entity 162), refer to Section 4.2.5.8.

4.2.5.21 Envelope Shape Solid of Linear Extrusion (Entity 164)

Directory Entry and Parameter Data

Same requirements as listed for Envelope Shape Definition Solid of Linear Extrusion (Entity 164), refer to Section 4.2.5.9.

4.2.5.22 Installed Access Envelope Model Space Location and Orientation (Entity 124, Form 0)

Directory Entry

<u>Field #</u>	<u>Field Name</u>	<u>Description</u>
1	Entity Type Number	124
2	Parameter Data	Pointer to corresponding PD record, see Note 1
3	Structure	0 or blank
4	Line Font Pattern	0 or blank
5	Level	0 or blank
6	View	0 or blank
7	Transformation Matrix	0 or blank
8	Label Pointer	0 or blank
9A	Blank Status	00
9B	Subordinate Switch	00
9C	Entity Use	00
9D	Hierarchy	00
10	Sequence Number	DE line number, see Note 2
11	Entity Type Number	124
12	Line Weight	0 or blank
13	Color Number	0 or blank
14	Parameter Line Count	Number of lines in PD record, see Note 3
15	Form Number	0 or 1
16	Reserved	Blank
17	Reserved	Blank
18	Entity Label	Optional, see Note 7
19	Entity Subscript No.	Optional, see Note 8
20	Sequence Number	DE line number, see Note 4

Parameter Data

<u>Index</u>	<u>Description</u>
1-3	First row of rotation matrix which defines envelope orientation in model space
4	X coordinate of envelope location in model space
5-7	Second row of rotation matrix which defines envelope orientation in model space
8	Y coordinate of envelope location in model space
9-11	Third row of rotation matrix which defines envelope orientation in model space
12	Z coordinate of envelope location in model space
13	Number of associativity instance pointers (= 0 or blank)
14	Number of property pointers (= 0 or blank)

4.2.5.23 Installed Access Envelope Attributes (Entity 422, Form 0)

Directory Entry

<u>Field #</u>	<u>Field Name</u>	<u>Description</u>
1	Entity Type Number	422
2	Parameter Data	Pointer to corresponding PD record, see Note 1
3	Structure	Negative pointer to attribute definition, see Note 6
4	Line Font Pattern	0 or blank
5	Level	0 or blank
6	View	0 or blank
7	Transformation Matrix	0 or blank
8	Label Pointer	0 or blank
9A	Blank Status	00
9B	Subordinate Switch	02
9C	Entity Use	03
9D	Hierarchy	00
10	Sequence Number	DE line number, see Note 2
11	Entity Type Number	422
12	Line Weight	0 or blank
13	Color Number	0 or blank
14	Parameter Line Count	Number of lines in PD record, see Note 3
15	Form Number	0
16	Reserved	Blank
17	Reserved	Blank
18	Entity Label	Optional, see Note 7
19	Entity Subscript No.	Optional, see Note 8
20	Sequence Number	DE line number, see Note 4

Parameter Data

<u>Index</u>	<u>Description</u>
1	Object envelope type value (AT = 17, ALT = 4)
.	.
.	.
.	.
N	Last attribute value
N+1	Number of associativity instance pointers (= 0 or blank)
N+2	Number of property pointers (= 0 or blank)

4.2.5.24 Installed Access Envelope Attributes Definition (Entity 322, Form 0)

Directory Entry

<u>Field #</u>	<u>Field Name</u>	<u>Description</u>
1	Entity Type Number	322
2	Parameter Data	Pointer to corresponding PD record, see Note 1
3	Structure	0 or blank
4	Line Font Pattern	0 or blank
5	Level	0 or blank
6	View	0 or blank
7	Transformation Matrix	0 or blank
8	Label Pointer	0 or blank
9A	Blank Status	00
9B	Subordinate Switch	00
9C	Entity Use	02
9D	Hierarchy	00
10	Sequence Number	DE line number, see Note 2
11	Entity Type Number	322
12	Line Weight	0 or blank
13	Color Number	0 or blank
14	Parameter Line Count	Number of lines in PD record, see Note 3
15	Form Number	0
16	Reserved	Blank
17	Reserved	Blank
18	Entity Label	Optional, see Note 7
19	Entity Subscript No.	Optional, see Note 8
20	Sequence Number	DE line number, see Note 4

Parameter Data

<u>Index</u>	<u>Description</u>
1	Attribute table name (= 25HINSTALLED ACCESS ENVELOPE)
2	Attribute list type (= 4)
3	Number of attributes in table (= N)
4	First attribute type (= 17)
5	First attribute value data type (= 3)
6	First attribute value count (= 1)
.	.
.	.
.	.
N*3+1	Last attribute type
N*3+2	Last attribute value data type
N*3+3	Last attribute value count (AVC(N) = 1)
N*3+4	Number of associativity instance pointers (= 0 or blank)
N*3+5	Number of property pointers (= 0 or blank)

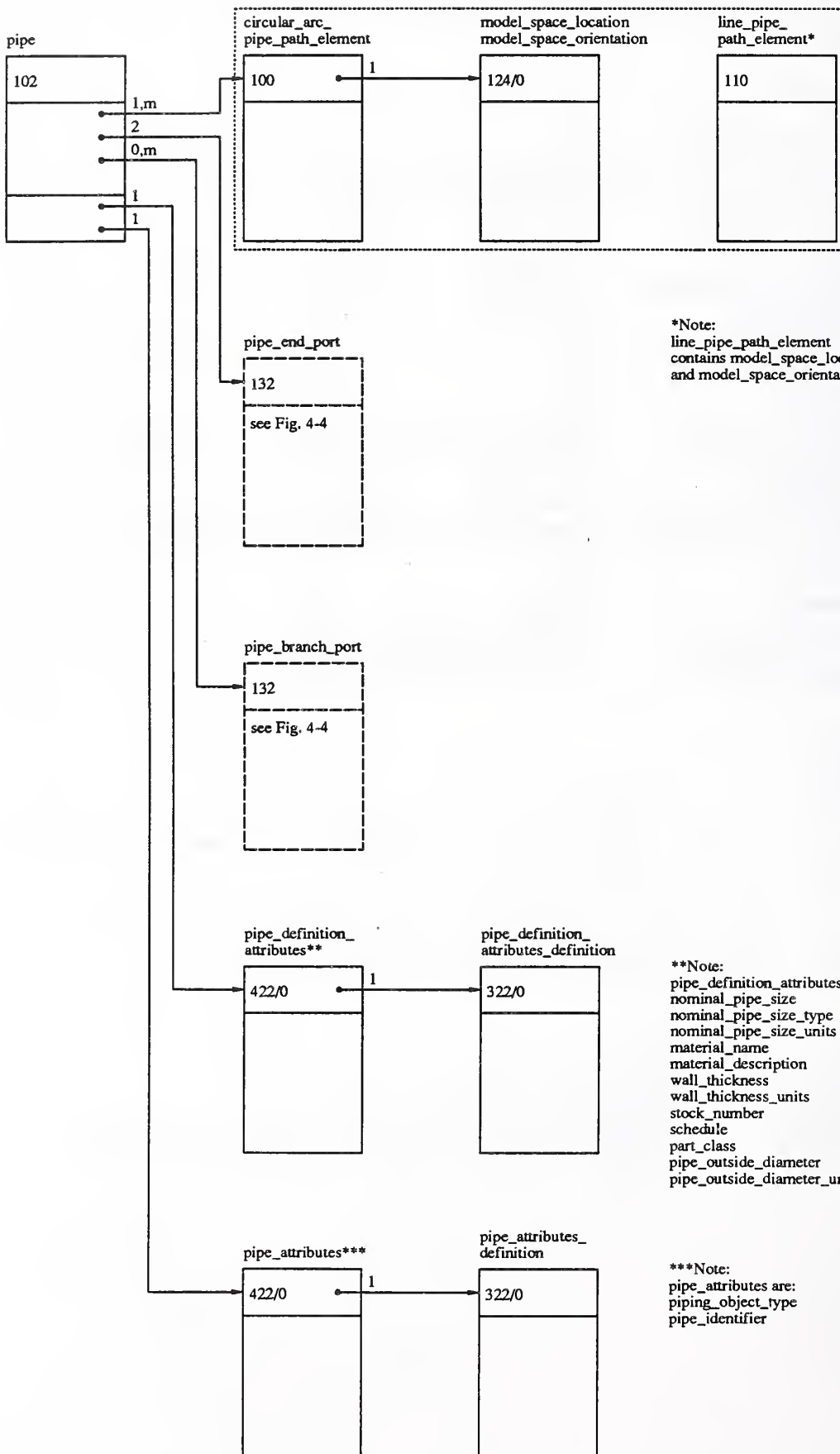

*Note:
line_pipe_path_element
contains model_space_location
and model_space_orientation

**Note:
pipe_definition_attributes are:
nominal_pipe_size
nominal_pipe_size_type
nominal_pipe_size_units
material_name
material_description
wall_thickness
wall_thickness_units
stock_number
schedule
part_class
pipe_outside_diameter
pipe_outside_diameter_units

***Note:
pipe_attributes are:
piping_object_type
pipe_identifier

4.2.6 Pipe

4.2.6.1 Pipe Composite Curve (Entity 102)

Directory Entry

<u>Field #</u>	<u>Field Name</u>	<u>Description</u>
1	Entity Type Number	102
2	Parameter Data	Pointer to corresponding PD record, see Note 1
3	Structure	0 or blank
4	Line Font Pattern	0 or blank
5	Level	0 or blank
6	View	0 or blank
7	Transformation Matrix	0 or blank
8	Label Pointer	0 or blank
9A	Blank Status	00
9B	Subordinate Switch	00 or 02
9C	Entity Use	00
9D	Hierarchy	00
10	Sequence Number	DE line number, see Note 2
11	Entity Type Number	102
12	Line Weight	0 or blank
13	Color Number	0 or blank
14	Parameter Line Count	Number of lines in PD record, see Note 3
15	Form Number	0
16	Reserved	Blank
17	Reserved	Blank
18	Entity Label	Optional, see Note 7
19	Entity Subscript No.	Optional, see Note 8
20	Sequence Number	DE line number, see Note 4

Parameter Data

<u>Index</u>	<u>Description</u>
1	Number of entity pointers (= N)
2	Pointer to first pipe end port (Entity 132)
3	Pointer to first pipe path element (Entity 110 or 100)
4	Pointer to next pipe path element (Entity 110 or 100) or pipe branch port (Entity 132)
.	.
.	.
.	.
N	Pointer to last pipe path element (Entity 110 or 100)
N+1	Pointer to second pipe end port (Entity 132)
N+2	Number of associativity instance pointers (= 0 or blank)
N+3	Number of property pointers (= 2)
N+4	Pointer to pipe definition attribute table instance (Entity 422/0)
N+5	Pointer to pipe attribute table instance (Entity 422/0)

4.2.6.2 Circular Arc Pipe Path Element (Entity 100)

Directory Entry

<u>Field #</u>	<u>Field Name</u>	<u>Description</u>
1	Entity Type Number	100
2	Parameter Data	Pointer to corresponding PD record, see Note 1
3	Structure	0 or blank
4	Line Font Pattern	0 or blank
5	Level	0 or blank
6	View	0 or blank
7	Transformation Matrix	Pointer to tranformation matrix, see Note 5
8	Label Pointer	0 or blank
9A	Blank Status	00
9B	Subordinate Switch	01
9C	Entity Use	00
9D	Hierarchy	00
10	Sequence Number	DE line number, see Note 2
11	Entity Type Number	00
12	Line Weight	0 or blank
13	Color Number	0 or blank
14	Parameter Line Count	Number of lines in PD record, see Note 3
15	Form Number	0
16	Reserved	Blank
17	Reserved	Blank
18	Entity Label	Optional, see Note 7
19	Entity Subscript No.	Optional, see Note 8
20	Sequence Number	DE line number, see Note 4

Parameter Data

<u>Index</u>	<u>Description</u>
1	ZT displacement from XT, YT plane
2	Arc center x coordinate
3	Arc center y coordinate
4	Start point x coordinate
5	Start point y coordinate
6	End point x coordinate
7	End point y coordinate
8	Number of associativity instance pointer (= 0 or blank)
9	Number of property pointers (= 0 or blank)

4.2.6.3 Circular Arc Pipe Path Element - Model Space Location and Orientation (Entity 124)

Directory Entry

<u>Field #</u>	<u>Field Name</u>	<u>Description</u>
1	Entity Type Number	124
2	Parameter Data	Pointer to corresponding PD record, see Note 1
3	Structure	0 or blank
4	Line Font Pattern	0 or blank
5	Level	0 or blank
6	View	0 or blank
7	Transformation Matrix	0 or blank
8	Label Pointer	0 or blank
9A	Blank Status	00
9B	Subordinate Switch	00
9C	Entity Use	00
9D	Hierarchy	00
10	Sequence Number	DE line number, see Note 2
11	Entity Type Number	124
12	Line Weight	0 or blank
13	Color Number	0 or blank
14	Parameter Line Count	Number of lines in PD record, see Note 3
15	Form Number	0 or 1
16	Reserved	Blank
17	Reserved	Blank
18	Entity Label	Optional, see Note 7
19	Entity Subscript No.	Optional, see Note 8
20	Sequence Number	DE line number, see Note 4

Parameter Data

<u>Index</u>	<u>Description</u>
1-3	First row of rotation matrix which orients the circular arc pipe path element in model space
4	X coordinate of translation which locates the circular arc pipe path element in model space
5-7	Second row of rotation matrix which orients the circular arc pipe path element in model space
8	Y coordinate of translation which locates the circular arc pipe path element in model space
9-11	Third row of rotation matrix which orients the circular arc pipe path element in model space
12	Z coordinate of translation which locates the circular arc pipe path element in model space
13	Number of associativity instance pointers (= 0 or blank)
14	Number of property pointers (= 0 or blank)

4.2.6.4 Line Pipe Path Element (Entity 110)

Directory Entry

<u>Field #</u>	<u>Field Name</u>	<u>Description</u>
1	Entity Type Number	110
2	Parameter Data	Pointer to corresponding PD record, see Note 1
3	Structure	0 or blank
4	Line Font Pattern	0 or blank
5	Level	0 or blank
6	View	0 or blank
7	Transformation Matrix	Pointer to transformation matrix, see Note 5
8	Label Pointer	0 or blank
9A	Blank Status	00
9B	Subordinate Switch	01
9C	Entity Use	00
9D	Hierarchy	00
10	Sequence Number	DE line number, see Note 2
11	Entity Type Number	110
12	Line Weight	0 or blank
13	Color Number	0 or blank
14	Parameter Line Count	Number of lines in PD record, see Note 3
15	Form Number	0
16	Reserved	Blank
17	Reserved	Blank
18	Entity Label	Optional, see Note 7
19	Entity Subscript No.	Optional, see Note 8
20	Sequence Number	DE line number, see Note 4

Parameter Data

<u>Index</u>	<u>Description</u>
1	Start point x coordinate in model space
2	Start point y coordinate in model space
3	Start point z coordinate in model space
4	End point x coordinate in model space
5	End point y coordinate in model space
6	End point z coordinate in model space
7	Number of associativity instance pointers (= 0 or blank)
8	Number of property pointers (= 0 or blank)

4.2.6.5 Pipe Definition Attributes (Entity 422, Form 0)

Directory Entry

<u>Field #</u>	<u>Field Name</u>	<u>Description</u>
1	Entity Type Number	422
2	Parameter Data	Pointer to corresponding PD record, see Note 1
3	Structure	Negative pointer to attribute definition, see Note 6
4	Line Font Pattern	0 or blank
5	Level	0 or blank
6	View	0 or blank
7	Transformation Matrix	0 or blank
8	Label Pointer	0 or blank
9A	Blank Status	00
9B	Subordinate Switch	00
9C	Entity Use	03
9D	Hierarchy	00
10	Sequence Number	DE line number, see Note 2
11	Entity Type Number	422
12	Line Weight	0 or blank
13	Color Number	0 or blank
14	Parameter Line Count	Number of lines in PD record, see Note 3
15	Form Number	0
16	Reserved	Blank
17	Reserved	Blank
18	Entity Label	Optional, see Note 7
19	Entity Subscript No.	Optional, see Note 8
20	Sequence Number	DE line number, see Note 4

Parameter Data

<u>Index</u>	<u>Description</u>
1	Nominal pipe size value (AT = 1, ALT = 4)
2	Nominal pipe size type value (AT = 18, ALT = 4)
3	Nominal pipe size units value (AT = 57, ALT = 4)
4	Material name value (AT = 2, ALT = 4)
5	Material description value (AT = 50, ALT = 4)
6	Wall thickness value (AT = 4, ALT = 4)
7	Wall thickness units value (AT = 28, ALT = 4)
8	Stock number value (AT = 5, ALT = 4)
9	Schedule value (AT = 23, ALT = 4)
10	Part class value (AT = 36, ALT = 4)
11	Pipe outside diameter value (AT = 98, ALT = 4)
12	Pipe outside diameter units value (AT = 99, ALT = 4)
.	.
.	.
.	.
N	Last attribute value
N+1	Number of associativity instance pointers (= 0 or blank)
N+2	Number of property pointers (= 0 or blank)

4.2.6.6 Pipe Definition Attributes Definition (Entity 322, Form 0)

Directory Entry

<u>Field #</u>	<u>Field Name</u>	<u>Description</u>
1	Entity Type Number	322
2	Parameter Data	Pointer to corresponding PD record, see Note 1
3	Structure	0 or blank
4	Line Font Pattern	0 or blank
5	Level	0 or blank
6	View	0 or blank
7	Transformation Matrix	0 or blank
8	Label Pointer	0 or blank
9A	Blank Status	00
9B	Subordinate Switch	00
9C	Entity Use	02
9D	Hierarchy	00
10	Sequence Number	DE line number, see Note 2
11	Entity Type Number	322
12	Line Weight	0 or blank
13	Color Number	0 or blank
14	Parameter Line Count	Number of lines in PD record, see Note 3
15	Form Number	0
16	Reserved	Blank
17	Reserved	Blank
18	Entity Label	Optional, see Note 7
19	Entity Subscript No.	Optional, see Note 8
20	Sequence Number	DE line number, see Note 4

Parameter Data

<u>Index</u>	<u>Description</u>
1	Attribute table name (= 15HPIPE DEFINITION)
2	Attribute list type (= 4)
3	Number of attributes in table (= N)
4	First attribute type (= 1)
5	First attribute value data type (= 2)
6	First attribute value count (= 1)
7	Second attribute type (= 18)
8	Second attribute value data type (= 3)
9	Second attribute value count (= 1)
10	Third attribute type (= 57)
11	Third attribute value data type (= 3)
12	Third attribute value count (= 1)
13	Fourth attribute type (= 2)
14	Fourth attribute value data type (= 3)
15	Fourth attribute value count (= 1)
16	Fifth attribute type (= 50)
17	Fifth attribute value data type (= 3)
18	Fifth attribute value count (= 1)
19	Sixth attribute type (= 4)
20	Sixth attribute value data type (= 2)
21	Sixth attribute value count (= 1)

22	Seventh attribute type (= 28)
23	Seventh attribute value data type (= 3)
24	Seventh attribute value count (= 1)
25	Eighth attribute type (= 5)
26	Eighth attribute value data type (= 3)
27	Eighth attribute value count (= 1)
28	Ninth attribute type (= 23)
29	Ninth attribute value data type (= 3)
30	Ninth attribute value count (= 1)
31	Tenth attribute type (= 36)
32	Tenth attribute value data type (= 3)
33	Tenth attribute value count (= 1)
34	Eleventh attribute type (= 98)
35	Eleventh attribute value data type (= 2)
36	Eleventh attribute value count (= 1)
37	Twelfth attribute type (= 99)
38	Twelfth attribute value data type (= 3)
39	Twelfth attribute value count (= 1)
.	.
.	.
.	.
N*3+1	Last attribute type
N*3+2	Last attribute value data type
N*3+3	Last attribute value count (AVC(N) = 1)
N*3+4	Number of associativity instance pointers (= 0 or blank)
N*3+5	Number of property pointers (= 0 or blank)

4.2.6.7 Pipe Attributes (Entity 422, Form 0)

Directory Entry

<u>Field #</u>	<u>Field Name</u>	<u>Description</u>
1	Entity Type Number	422
2	Parameter Data	Pointer to corresponding PD record, see Note 1
3	Structure	Negative pointer to attribute definition, see Note 6
4	Line Font Pattern	0 or blank
5	Level	0 or blank
6	View	0 or blank
7	Transformation Matrix	0 or blank
8	Label Pointer	0 or blank
9A	Blank Status	00
9B	Subordinate Switch	00
9C	Entity Use	03
9D	Hierarchy	00
10	Sequence Number	DE line number, see Note 2
11	Entity Type Number	422
12	Line Weight	0 or blank
13	Color Number	0 or blank
14	Parameter Line Count	Number of lines in PD record, see Note 3
15	Form Number	0
16	Reserved	Blank
17	Reserved	Blank
18	Entity Label	Optional, see Note 7
19	Entity Subscript No.	Optional, see Note 8
20	Sequence Number	DE line number, see Note 4

Parameter Data

<u>Index</u>	<u>Description</u>
1	Piping object type value (AT = 17, ALT = 4)
2	Pipe identifier value (AT = 19, ALT = 4)
.	.
.	.
.	.
N	Last attribute value
N+1	Number of associativity instance pointers (= 0 or blank)
N+2	Number of property pointers (= 0 or blank)

4.2.6.8 Pipe Attributes Definition (Entity 322, Form 0)

Directory Entry

<u>Field #</u>	<u>Field Name</u>	<u>Description</u>
1	Entity Type Number	322
2	Parameter Data	Pointer to corresponding PD record, see Note 1
3	Structure	0 or blank
4	Line Font Pattern	0 or blank
5	Level	0 or blank
6	View	0 or blank
7	Transformation Matrix	0 or blank
8	Label Pointer	0 or blank
9A	Blank Status	00
9B	Subordinate Switch	00
9C	Entity Use	02
9D	Hierarchy	00
10	Sequence Number	DE line number, see Note 2
11	Entity Type Number	322
12	Line Weight	0 or blank
13	Color Number	0 or blank
14	Parameter Line Count	Number of lines in PD record, see Note 3
15	Form Number	0
16	Reserved	Blank
17	Reserved	Blank
18	Entity Label	Optional, see Note 7
19	Entity Subscript No.	Optional, see Note 8
20	Sequence Number	DE line number, see Note 4

Parameter Data

<u>Index</u>	<u>Description</u>
1	Attribute table name (= 4HPIPE)
2	Attribute list type (= 4)
3	Number of attributes in table (= N)
4	First attribute type (= 17)
5	First attribute value data type (= 3)
6	First attribute value count (= 1)
7	Second attribute type (= 19)
8	Second attribute value data type (= 3)
9	Second attribute value count (= 1)
.	.
.	.
.	.
N*3+1	Last attribute type
N*3+2	Last attribute value data type
N*3+3	Last attribute value count (AVC(N) = 1)
N*3+4	Number of associativity instance pointers (= 0 or blank)
N*3+5	Number of property pointers (= 0 or blank)

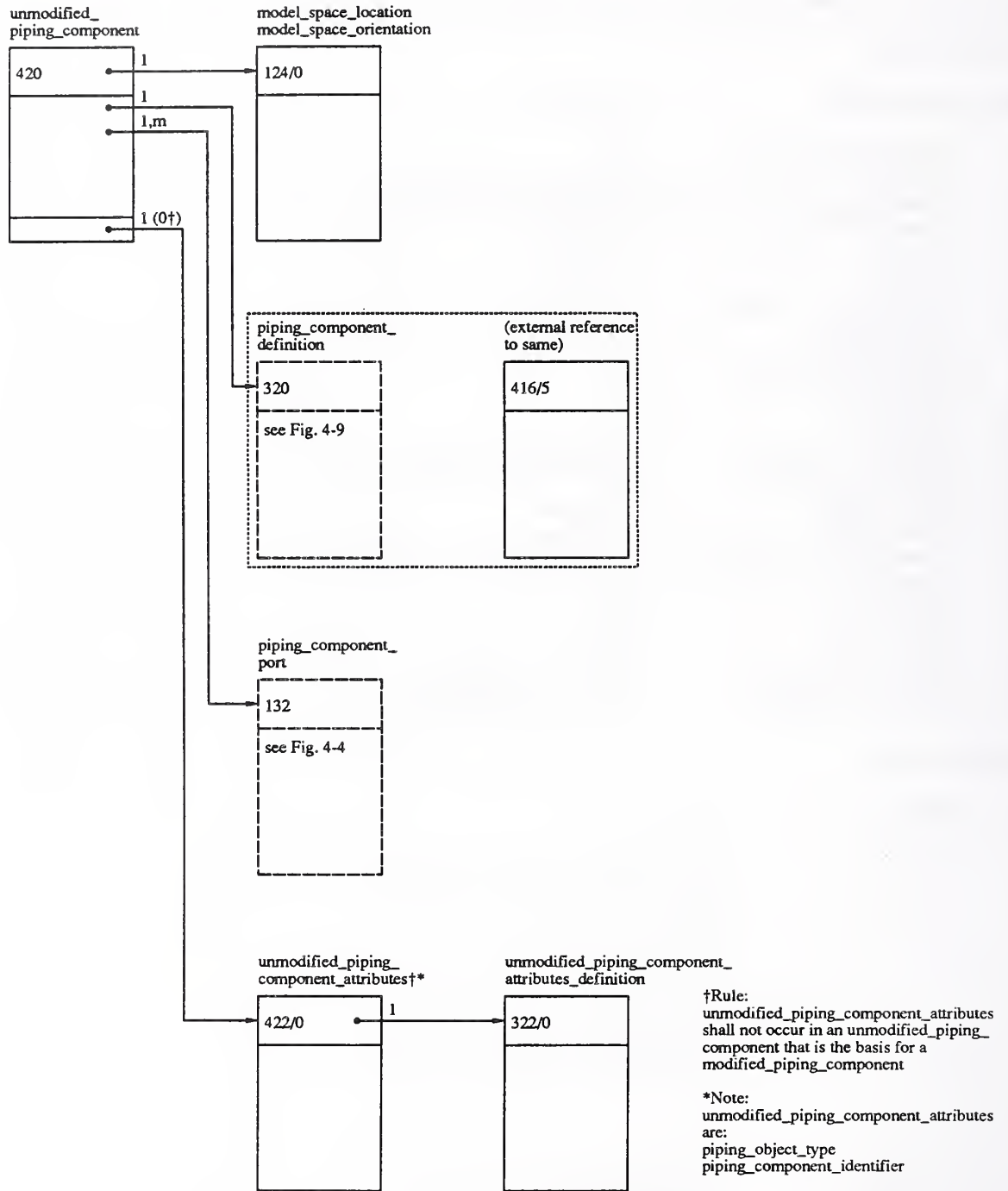

4.2.7 Unmodified Piping Component

4.2.7.1 Unmodified Piping Component Network Subfigure Instance (Entity 420)

Directory Entry

<u>Field #</u>	<u>Field Name</u>	<u>Description</u>
1	Entity Type Number	420
2	Parameter Data	Pointer to corresponding PD record, see Note 1
3	Structure	0 or blank
4	Line Font Pattern	0 or blank
5	Level	0 or blank
6	View	0 or blank
7	Transformation Matrix	Pointer to transformation matrix, see Note 5
8	Label Pointer	0 or blank
9A	Blank Status	00
9B	Subordinate Switch	00 or 02
9C	Entity Use	00
9D	Hierarchy	00
10	Sequence Number	DE line number, see Note 2
11	Entity Type Number	420
12	Line Weight	0 or blank
13	Color Number	0 or blank
14	Parameter Line CountN	Number of lines in PD record, see Note 3
15	Form Number	0
16	Reserved	Blank
17	Reserved	Blank
18	Entity Label	Optional, see Note 7
19	Entity Subscript No.	Optional, see Note 8
20	Sequence Number	DE line number, see Note 4

Parameter Data

<u>Index</u>	<u>Description</u>
1	Pointer to piping component definition (Entity 320) or external reference (Entity 416/5)
2	Translation in X direction (= 0.0)
3	Translation in Y direction (= 0.0)
4	Translation in Z direction (= 0.0)
5	Scale factor in X direction (= 1.0)
6	Scale factor in Y direction (= 1.0)
7	Scale factor in Z direction (= 1.0)
8	Type Flag (= 2)
9	Primary reference designator (= blank)
10	Pointer to directory entry of the primary reference designator text display template (= 0 or blank)
11	Number of piping component ports (= N)
12	Pointer to first piping component port (Entity 132)
.	.
.	.
.	.
N+11	Pointer to last piping component port (Entity 132)
N+12	Number of associativity instance pointers (= 0)

N+13
N+14

Number of property pointers (= 1)
Pointer to unmodified piping component attribute table instance (Entity
422/0)

4.2.7.2 Unmodified Piping Component - Model Space Location and Orientation (Entity 124)

Directory Entry

<u>Field #</u>	<u>Field Name</u>	<u>Description</u>
1	Entity Type Number	124
2	Parameter Data	Pointer to corresponding PD record, see Note 1
3	Structure	0 or blank
4	Line Font Pattern	0 or blank
5	Level	0 or blank
6	View	0 or blank
7	Transformation Matrix	0 or blank
8	Label Pointer	0 or blank
9A	Blank Status	00
9B	Subordinate Switch	00
9C	Entity Use	00
9D	Hierarchy	00
10	Sequence Number	DE line number, see Note 2
11	Entity Type Number	124
12	Line Weight	0 or blank
13	Color Number	0 or blank
14	Parameter Line Count	Number of lines in PD record, see Note 3
15	Form Number	0
16	Reserved	Blank
17	Reserved	Blank
18	Entity Label	Optional, see Note 7
19	Entity Subscript No.	Optional, see Note 8
20	Sequence Number	DE line number, see Note 4

Parameter Data

<u>Index</u>	<u>Description</u>
1-3	First row of rotation matrix which defines unmodified piping component orientation in model space
4	X coordinate of unmodified piping component location in model space
5-7	Second row of rotation matrix which defines unmodified piping component orientation in model space
8	Y coordinate of unmodified piping component location in model space
9-11	Third row of rotation matrix which defines unmodified piping component orientation in model space
12	Z coordinate of unmodified piping component location in model space
13	Number of associativity instance pointers (= 0 or blank)
14	Number of property pointers (= 0 or blank)

4.2.7.3 Piping Component Definition External Reference (Entity 416, Form 5)

Directory Entry

<u>Field #</u>	<u>Field Name</u>	<u>Description</u>
1	Entity Type Number	416
2	Parameter Data	Pointer to corresponding PD record, see Note 1
3	Structure	0 or blank
4	Line Font Pattern	0 or blank
5	Level	0 or blank
6	View	0 or blank
7	Transformation Matrix	0 or blank
8	Label Pointer	0 or blank
9A	Blank Status	00
9B	Subordinate Switch	00
9C	Entity Use	04
9D	Hierarchy	00
10	Sequence Number	DE line number, see Note 2
11	Entity Type Number	416
12	Line Weight	0 or blank
13	Color Number	0 or blank
14	Parameter Line Count	Number of lines in PD record, see Note 3
15	Form Number	5
16	Reserved	Blank
17	Reserved	Blank
18	Entity Label	Optional, see Note 7
19	Entity Subscript No.	Optional, see Note 8
20	Sequence Number	DE line number, see Note 4

Parameter Data

<u>Index</u>	<u>Description</u>
1	External reference entity symbolic name
2	Number of associativity instance pointers (= 0 or blank)
3	Number of property pointers (= 0 or blank)

4.2.7.4 Unmodified Piping Component Attributes (Entity 422, Form 0)

Directory Entry

<u>Field #</u>	<u>Field Name</u>	<u>Description</u>
1	Entity Type Number	422
2	Parameter Data	Pointer to corresponding PD record, see Note 1
3	Structure	Negative pointer to attribute definition, see Note 6
4	Line Font Pattern	0 or blank
5	Level	0 or blank
6	View	0 or blank
7	Transformation Matrix	0 or blank
8	Label Pointer	0 or blank
9A	Blank Status	00
9B	Subordinate Switch	00
9C	Entity Use	03
9D	Hierarchy	00
10	Sequence Number	DE line number, see Note 2
11	Entity Type Number	422
12	Line Weight	0 or blank
13	Color Number	0 or blank
14	Parameter Line Count	Number of lines in PD record, see Note 3
15	Form Number	0
16	Reserved	Blank
17	Reserved	Blank
18	Entity Label	Optional, see Note 7
19	Entity Subscript No.	Optional, see Note 8
20	Sequence Number	DE line number, see Note 4

Parameter Data

<u>Index</u>	<u>Description</u>
1	Piping object type value (AT = 17, ALT = 4)
2	Piping component identifier value (AT = 19, ALT = 4)
.	.
.	.
.	.
N	Last attribute value
N+1	Number of associativity instance pointers (= 0 or blank)
N+2	Number of property pointers (= 0 or blank)

4.2.7.5 Unmodified Piping Component Attributes Definition (Entity 322, Form 0)

Directory Entry

<u>Field #</u>	<u>Field Name</u>	<u>Description</u>
1	Entity Type Number	322
2	Parameter Data	Pointer to corresponding PD record, see Note 1
3	Structure	0 or blank
4	Line Font Pattern	0 or blank
5	Level	0 or blank
6	View	0 or blank
7	Transformation Matrix	0 or blank
8	Label Pointer	0 or blank
9A	Blank Status	00
9B	Subordinate Switch	00
9C	Entity Use	02
9D	Hierarchy	00
10	Sequence Number	DE line number, see Note 2
11	Entity Type Number	322
12	Line Weight	0 or blank
13	Color Number	0 or blank
14	Parameter Line Count	Number of lines in PD record, see Note 3
15	Form Number	0
16	Reserved	Blank
17	Reserved	Blank
18	Entity Label	Optional, see Note 7
19	Entity Subscript No.	Optional, see Note 8
20	Sequence Number	DE line number, see Note 4

Parameter Data

<u>Index</u>	<u>Description</u>
1	Attribute table name (= 27HUNMODIFIED PIPING COMPONENT)
2	Attribute list type (= 4)
3	Number of attributes in table (= N)
4	First attribute type (= 17)
5	First attribute value data type (= 3)
6	First attribute value count (= 1)
7	Second attribute type (= 19)
8	Second attribute value data type (= 3)
9	Second attribute value count (= 1)
.	.
.	.
.	.
N*3+1	Last attribute type
N*3+2	Last attribute value data type
N*3+3	Last attribute value count (AVC(N) = 1)
N*3+4	Number of associativity instance pointers (= 0 or blank)
N*3+5	Number of property pointers (= 0 or blank)

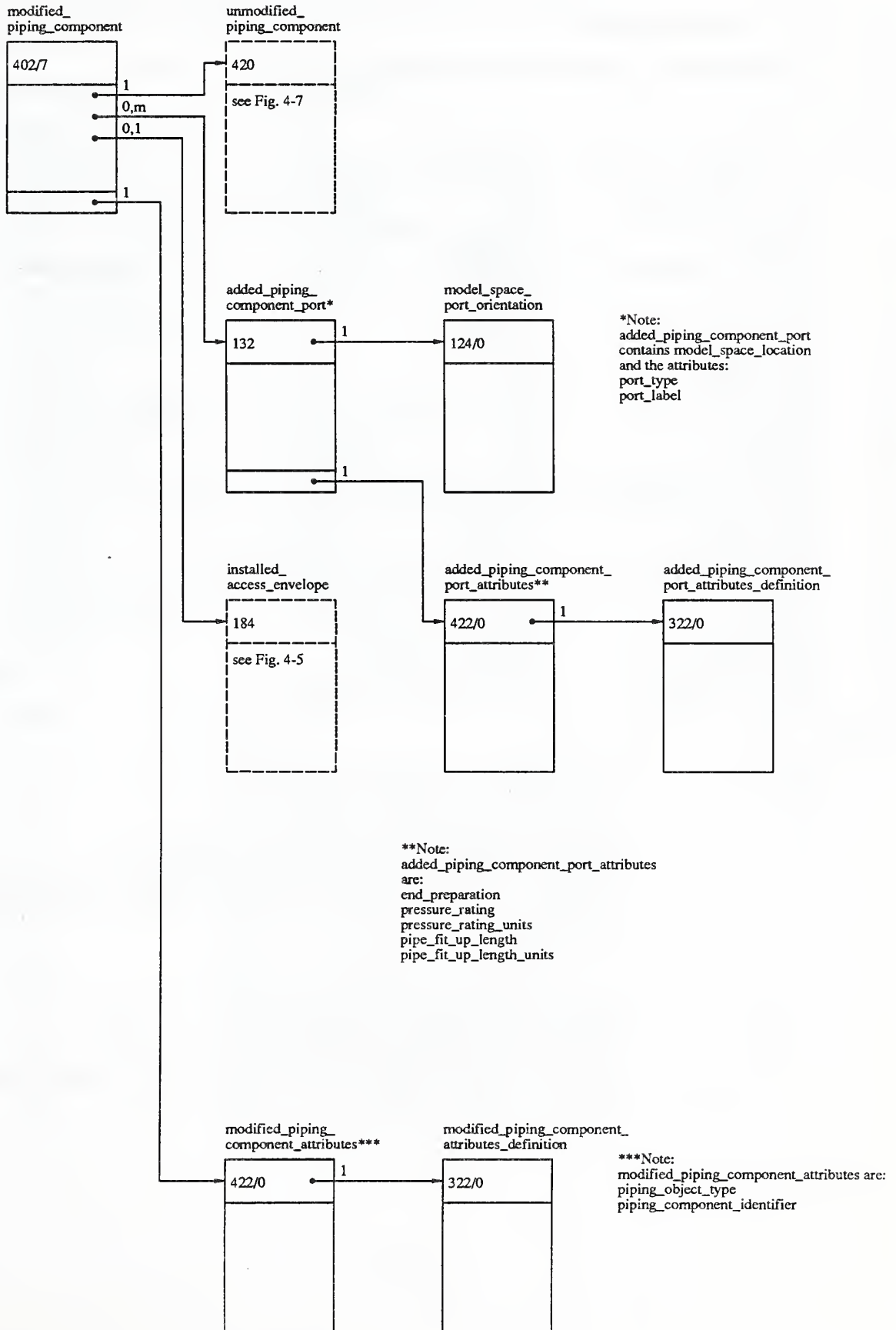

4.2.8 Modified Piping Component

4.2.8.1 Modified Piping Component Group Associativity (Entity 402, Form 7)

Directory Entry

<u>Field #</u>	<u>Field Name</u>	<u>Description</u>
1	Entity Type Number	402
2	Parameter Data	Pointer to corresponding PD record, see Note 1
3	Structure	0 or blank
4	Line Font Pattern	0 or blank
5	Level	0 or blank
6	View	0 or blank
7	Transformation Matrix	0 or blank
8	Label Pointer	0 or blank
9A	Blank Status	00
9B	Subordinate Switch	00
9C	Entity Use	03
9D	Hierarchy	00
10	Sequence Number	DE line number, see Note 2
11	Entity Type Number	402
12	Line Weight	0 or blank
13	Color Number	0 or blank
14	Parameter Line Count	Number of lines in PD record, see Note 3
15	Form Number	7
16	Reserved	Blank
17	Reserved	Blank
18	Entity Label	Optional, see Note 7
19	Entity Subscript No.	Optional, see Note 8
20	Sequence Number	DE line number, see Note 4

Parameter Data

<u>Index</u>	<u>Description</u>
1	Number of entity pointers (= N, $N \geq 2$)
2	Pointer to unmodified piping component (Entity 420)
3	Pointer to installed access envelope (Entity 184) or added piping component port (Entity 132) (Must point to installed access envelope if it exists)
.	.
.	.
.	.
N+1	Pointer to added piping component port
N+2	Number of associativity instance pointers (= 0 or blank)
N+3	Number of property pointers (= 1)
N+4	Pointer to modified piping component attribute table instance (Entity 422/0)

4.2.8.2 Added Piping Component Port Connect Point (Entity 132)

Directory Entry

<u>Field #</u>	<u>Field Name</u>	<u>Description</u>
1	Entity Type Number	132
2	Parameter Data	Pointer to corresponding PD record, see Note 1
3	Structure	0 or blank
4	Line Font Pattern	0 or blank
5	Level	0 or blank
6	View	0 or blank
7	Transformation Matrix	Pointer to transformation matrix, see Note 5
8	Label Pointer	0 or blank
9A	Blank Status	00
9B	Subordinate Switch	02
9C	Entity Use	04
9D	Hierarchy	00
10	Sequence Number	DE line number, see Note 2
11	Entity Type Number	132
12	Line Weight	0 or blank
13	Color Number	0 or blank
14	Parameter Line Count	Number of lines in PD record, see Note 3
15	Form Number	0 or blank
16	Reserved	Blank
17	Reserved	Blank
18	Entity Label	Optional, see Note 7
19	Entity Subscript No.	Optional, see Note 8
20	Sequence Number	DE line number, see Note 4

Parameter Data

<u>Index</u>	<u>Description</u>
1	X coordinate in model space location
2	Y coordinate in model space location
3	Z coordinate in model space location
4	Pointer to the display symbol geometry (= 0 or blank)
5	Type flag (= 2)
6	Function flag (= 2)
7	Port label (= blank)
8	Pointer to text display (= 0 or blank)
9	Port type (= 15HADDDED COMPONENT)
10	Pointer to text display (= 0 or blank)
11	Unique connect point identifier (= 0 or blank)
12	Connect point function code (= 0 or blank)
13	Swap flag (= 0 or blank)
14	Pointer to NSI, NSD (= 0 or blank)
15	Number of associativity instance pointers (= 0 or blank)
16	Number of property pointers (= 0 or blank)

4.2.8.3 Model Space Port Orientation (Entity 124, Form 0)

Directory Entry

<u>Field #</u>	<u>Field Name</u>	<u>Description</u>
1	Entity Type Number	124
2	Parameter Data	Pointer to corresponding PD record, see Note 1
3	Structure	0 or blank
4	Line Font Pattern	0 or blank
5	Level	0 or blank
6	View	0 or blank
7	Transformation Matrix	0 or blank
8	Label Pointer	0 or blank
9A	Blank Status	00
9B	Subordinate Switch	00
9C	Entity Use	00
9D	Hierarchy	00
10	Sequence Number	DE line number, see Note 2
11	Entity Type Number	124
12	Line Weight	0 or blank
13	Color Number	0 or blank
14	Parameter Line Count	Number of lines in PD record, see Note 3
15	Form Number	0 or 1
16	Reserved	Blank
17	Reserved	Blank
18	Entity Label	Optional, see Note 7
19	Entity Subscript No.	Optional, see Note 8
20	Sequence Number	DE line number, see Note 4

Parameter Data

<u>Index</u>	<u>Description</u>
1-3	First row of rotation matrix which provides piping port orientation in model space
4	X translation (T1 = 0 or blank)
5-7	Second row of rotation matrix which provides piping port orientation in model space
8	Y translation (T2 = 0 or blank)
9-11	Third row of rotation matrix which provides piping port orientation in model space
12	Z translation (T3 = 0 or blank)
13	Number of associativity instance pointers (= 0 or blank)
14	Number of property pointers (= 0 or blank)

4.2.8.4 Added Piping Component Port Attributes (Entity 422, Form 0)

Directory Entry

<u>Field #</u>	<u>Field Name</u>	<u>Description</u>
1	Entity Type Number	422
2	Parameter Data	Pointer to corresponding PD record, see Note 1
3	Structure	Negative pointer to attribute definition, see Note 6
4	Line Font Pattern	0 or blank
5	Level	0 or blank
6	View	0 or blank
7	Transformation Matrix	0 or blank
8	Label Pointer	0 or blank
9A	Blank Status	00
9B	Subordinate Switch	00
9C	Entity Use	03
9D	Hierarchy	00
10	Sequence Number	DE line number, see Note 2
11	Entity Type Number	422
12	Line Weight	0 or blank
13	Color Number	0 or blank
14	Parameter Line Count	Number of lines in PD record, see Note 3
15	Form Number	0
16	Reserved	Blank
17	Reserved	Blank
18	Entity Label	Optional, see Note 7
19	Entity Subscript No.	Optional, see Note 8
20	Sequence Number	DE line number, see Note 4

Parameter Data

<u>Index</u>	<u>Description</u>
1	End preparation (AT = 3, ALT = 4)
2	Pressure rating value (AT = 85, ALT = 4)
3	Pressure rating units value (AT = 86, ALT = 4)
4	Pipe fit up length (AT = 139, ALT = 4)
5	Pipe fit up length units (AT = 140, ALT = 4)
.	.
.	.
.	.
N	Last attribute value
N+1	Number of associativity instance pointers (= 0 or blank)
N+2	Number of property pointers (= 0 or blank)

4.2.8.5 Added Piping Component Port Attributes Definition (Entity 322, Form 0)

Directory Entry

<u>Field #</u>	<u>Field Name</u>	<u>Description</u>
1	Entity Type Number	322
2	Parameter Data	Pointer to corresponding PD record, see Note 1
3	Structure	0 or blank
4	Line Font Pattern	0 or blank
5	Level	0 or blank
6	View	0 or blank
7	Transformation Matrix	0 or blank
8	Label Pointer	0 or blank
9A	Blank Status	00
9B	Subordinate Switch	00
9C	Entity Use	02
9D	Hierarchy	00
10	Sequence Number	DE line number, see Note 2
11	Entity Type Number	322
12	Line Weight	0 or blank
13	Color Number	0 or blank
14	Parameter Line Count	Number of lines in PD record, see Note 3
15	Form Number	0
16	Reserved	Blank
17	Reserved	Blank
18	Entity Label	Optional, see Note 7
19	Entity Subscript No.	Optional, see Note 8
20	Sequence Number	DE line number, see Note 4

Parameter Data

<u>Index</u>	<u>Description</u>
1	Attribute table name (= 27HADDED PIPING COMPONENT PORT)
2	Attribute list type (= 4)
3	Number of attributes in table (= N)
4	First attribute type (= 3)
5	First attribute value data type (= 3)
6	First attribute value count (= 1)
7	Second attribute type (= 85)
8	Second attribute value data type (= 2)
9	Second attribute value count (= 1)
10	Third attribute type (= 86)
11	Third attribute value data type (= 3)
12	Third attribute value count (= 1)
13	Fourth attribute type (= 139)
14	Fourth attribute value data type (= 2)
15	Fourth attribute value count (= 1)
16	Fifth attribute type (= 140)
17	Fifth attribute value data type (= 3)
18	Fifth attribute value count (= 1)
.	.
.	.
.	.

N*3+1	Last attribute type
N*3+2	Last attribute value data type
N*3+3	Last attribute value count (AVC(N) = 1)
N*3+4	Number of associativity instance pointers (= 0 or blank)
N*3+5	Number of property pointers (= 0 or blank)

4.2.8.6 Modified Piping Component Attributes (Entity 422, Form 0)

Directory Entry

<u>Field #</u>	<u>Field Name</u>	<u>Description</u>
1	Entity Type Number	422
2	Parameter Data	Pointer to corresponding PD record, see Note 1
3	Structure	Negative pointer to attribute definition, see Note 6
4	Line Font Pattern	0 or blank
5	Level	0 or blank
6	View	0 or blank
7	Transformation Matrix	0 or blank
8	Label Pointer	0 or blank
9A	Blank Status	00
9B	Subordinate Switch	00
9C	Entity Use	03
9D	Hierarchy	00
10	Sequence Number	DE line number, see Note 2
11	Entity Type Number	422
12	Line Weight	0 or blank
13	Color Number	0 or blank
14	Parameter Line Count	Number of lines in PD record, see Note 3
15	Form Number	0
16	Reserved	Blank
17	Reserved	Blank
18	Entity Label	Optional, see Note 7
19	Entity Subscript No.	Optional, see Note 8
20	Sequence Number	DE line number, see Note 4

Parameter Data

<u>Index</u>	<u>Description</u>
1	Piping object type value (AT = 17, ALT = 4)
2	Piping component identifier value (AT = 19, ALT = 4)
.	.
.	.
.	.
N	Last attribute value
N+1	Number of associativity instance pointers (= 0 or blank)
N+2	Number of property pointers (= 0 or blank)

4.2.8.7 Modified Piping Component Attributes Definition (Entity 322, Form 0)

Directory Entry

<u>Field #</u>	<u>Field Name</u>	<u>Description</u>
1	Entity Type Number	322
2	Parameter Data	Pointer to corresponding PD record, see Note 1
3	Structure	0 or blank
4	Line Font Pattern	0 or blank
5	Level	0 or blank
6	View	0 or blank
7	Transformation Matrix	0 or blank
8	Label Pointer	0 or blank
9A	Blank Status	00
9B	Subordinate Switch	00
9C	Entity Use	02
9D	Hierarchy	00
10	Sequence Number	DE line number, see Note 2
11	Entity Type Number	322
12	Line Weight	0 or blank
13	Color Number	0 or blank
14	Parameter Line Count	Number of lines in PD record, see Note 3
15	Form Number	0
16	Reserved	Blank
17	Reserved	Blank
18	Entity Label	Optional, see Note 7
19	Entity Subscript No.	Optional, see Note 8
20	Sequence Number	DE line number, see Note 4

Parameter Data

<u>Index</u>	<u>Description</u>
1	Attribute table name (= 25HMODIFIED PIPING COMPONENT)
2	Attribute list type (= 4)
3	Number of attributes in table (= N)
4	First attribute type (= 17)
5	First attribute value data type (= 3)
6	First attribute value count (= 1)
7	Second attribute type (= 19)
8	Second attribute value data type (= 3)
9	Second attribute value count (= 1)
.	.
.	.
.	.
N*3+1	Last attribute type
N*3+2	Last attribute value data type
N*3+3	Last attribute value count (AVC(N) = 1)
N*3+4	Number of associativity instance pointers (= 0 or blank)
N*3+5	Number of property pointers (= 0 or blank)

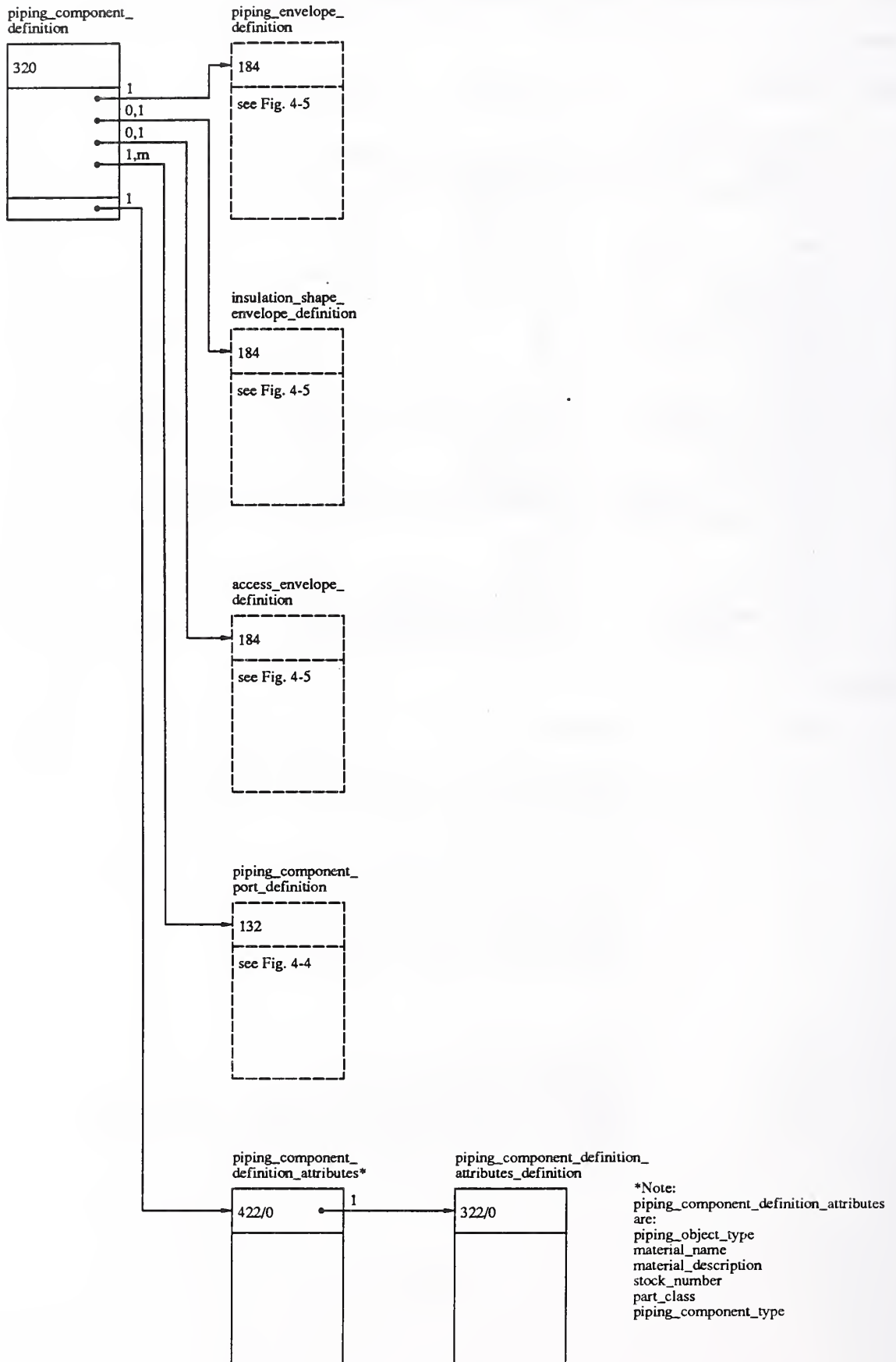

4.2.9 Piping Component Definition

4.2.9.1 Piping Component Network Subfigure Definition (Entity 320)

Directory Entry

<u>Field #</u>	<u>Field Name</u>	<u>Description</u>
1	Entity Type Number	320
2	Parameter Data	Pointer to corresponding PD record, see Note 1
3	Structure	0 or blank
4	Line Font Pattern	0 or blank
5	Level	0 or blank
6	View	0 or blank
7	Transformation Matrix	Pointer to transformation matrix, see Note 5
8	Label Pointer	0 or blank
9A	Blank Status	00
9B	Subordinate Switch	00
9C	Entity Use	02
9D	Hierarchy	00
10	Sequence Number	DE line number, see Note 2
11	Entity Type Number	320
12	Line Weight	0 or blank
13	Color Number	0 or blank
14	Parameter Line Count	Number of lines in PD record, see Note 3
15	Form Number	0
16	Reserved	Blank
17	Reserved	Blank
18	Entity Label	Optional, see Note 7
19	Entity Subscript No.	Optional, see Note 8
20	Sequence Number	DE line number, see Note 4

Parameter Data

<u>Index</u>	<u>Description</u>
1	Depth of subfigure (= 0)
2	Stock number
3	Number of associated object envelope definitions (= NA, $NA \geq 1$)
4	Pointer to piping envelope definition (Entity 184)
.	.
.	.
.	.
NA+3	Pointer to associated object envelope definition NA.
NA+4	Type flag (= 2)
NA+5	Primary reference designator (= 0 or blank)
NA+6	Pointer to the directory entry of the primary reference designator text display template (= 0 or blank)
NA+7	Number of associated piping component port definitions (= NC)
NA+8	Pointer to associated piping component port definition (Entity 132)
NA+NC+7	Pointer to associated piping component port definition NC (Entity 132)
NA+NC+8	Number of associativity instance pointers (= 0 or blank)
NA+NC+9	Number of property pointers (= 1)
NA+NC+10	Pointer to piping component definition attribute table instance (Entity 422/0)

4.2.9.2 Piping Component Definition Attributes (Entity 422, Form 0)

Directory Entry

<u>Field #</u>	<u>Field Name</u>	<u>Description</u>
1	Entity Type Number	422
2	Parameter Data	Pointer to corresponding PD record, see Note 1
3	Structure	Negative pointer to attribute definition, see Note 6
4	Line Font Pattern	0 or blank
5	Level	0 or blank
6	View	0 or blank
7	Transformation Matrix	0 or blank
8	Label Pointer	0 or blank
9A	Blank Status	00
9B	Subordinate Switch	00
9C	Entity Use	03
9D	Hierarchy	00
10	Sequence Number	DE line number, see Note 2
11	Entity Type Number	422
12	Line Weight	0 or blank
13	Color Number	0 or blank
14	Parameter Line Count	Number of lines in PD record, see Note 3
15	Form Number	0
16	Reserved	Blank
17	Reserved	Blank
18	Entity Label	Optional, see Note 7
19	Entity Subscript No.	Optional, see Note 8
20	Sequence Number	DE line number, see Note 4

Parameter Data

<u>Index</u>	<u>Description</u>
1	Piping object type value (AT = 17, ALT = 4)
2	Material name value (AT = 2, ALT = 4)
3	Material description value (AT = 50, ALT = 4)
4	Stock number value (AT = 5, ALT = 4)
5	Part class value (AT = 36, ALT = 4)
6	Piping component type value (AT = 38, ALT = 4)
.	.
.	.
.	.
N	Last attribute value
N+1	Number of associativity instance pointers (= 0 or blank)
N+2	Number of property pointers (= 0 or blank)

4.2.9.3 Piping Component Definition Attributes Definition (Entity 322, Form 0)

Directory Entry

<u>Field #</u>	<u>Field Name</u>	<u>Description</u>
1	Entity Type Number	322
2	Parameter Data	Pointer to corresponding PD record, see Note 1
3	Structure	0 or blank
4	Line Font Pattern	0 or blank
5	Level	0 or blank
6	View	0 or blank
7	Transformation Matrix	0 or blank
8	Label Pointer	0 or blank
9A	Blank Status	00
9B	Subordinate Switch	00
9C	Entity Use	02
9D	Hierarchy	00
10	Sequence Number	DE line number, see Note 2
11	Entity Type Number	322
12	Line Weight	0 or blank
13	Color Number	0 or blank
14	Parameter Line Count	Number of lines in PD record, see Note 3
15	Form Number	0
16	Reserved	Blank
17	Reserved	Blank
18	Entity Label	Optional, see Note 7
19	Entity Subscript No.	Optional, see Note 8
20	Sequence Number	DE line number, see Note 4

Parameter Data

<u>Index</u>	<u>Description</u>
1	Attribute table name (= 27HPIPING COMPONENT DEFINITION)
2	Attribute list type (= 4)
3	Number of attributes in table (= N)
4	First attribute type (= 17)
5	First attribute value data type (= 3)
6	First attribute value count (= 1)
7	Second attribute type (= 2)
8	Second attribute value data type (= 3)
9	Second attribute value count (= 1)
10	Third attribute type (= 50)
11	Third attribute value data type (= 3)
12	Third attribute value count (= 1)
13	Fourth attribute type (= 5)
14	Fourth attribute value data type (= 3)
15	Fourth attribute value count (= 1)
16	Fifth attribute type (= 36)
17	Fifth attribute value data type (= 3)
18	Fifth attribute value count (= 1)
19	Sixth attribute type (= 38)
20	Sixth attribute value data type (= 3)

21	Sixth attribute value count (= 1)
.	.
.	.
.	.
N*3+1	Last attribute type
N*3+2	Last attribute value data type
N*3+3	Last attribute value count (AVC(N) = 1)
N*3+4	Number of associativity instance pointers (= 0 or blank)
N*3+5	Number of property pointers (= 0 or blank)

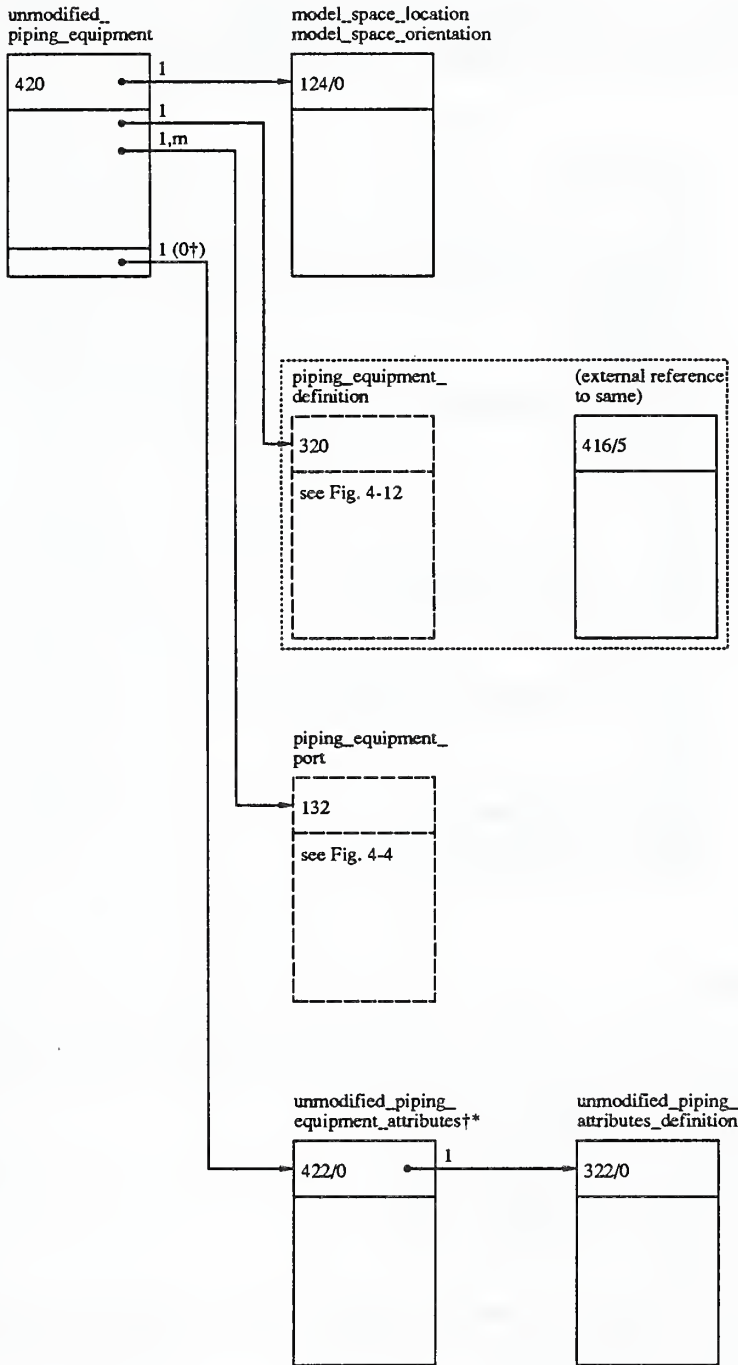

4.2.10 Unmodified Piping Equipment

4.2.10.1 Unmodified Piping Equipment Network Subfigure Instance (Entity 420)

Directory Entry

<u>Field#</u>	<u>Field Name</u>	<u>Description</u>
1	Entity Type Number	420
2	Parameter Data	Pointer to corresponding PD record, see Note 1
3	Structure	0 or blank
4	Line Font Pattern	0 or blank
5	Level	0 or blank
6	View	0 or blank
7	Transformation Matrix	Pointer to transformation matrix, see Note 5
8	Label Pointer	0 or blank
9A	Blank Status	00
9B	Subordinate Switch	00 or 02
9C	Entity Use	00
9D	Hierarchy	00
10	Sequence Number	DE line number, see Note 2
11	Entity Type Number	420
12	Line Weight	0 or blank
13	Color Number	0 or blank
14	Parameter Line Count	Number of lines in PD record, see Note 3
15	Form Number	0
16	Reserved	Blank
17	Reserved	Blank
18	Entity Label	Optional, see Note 7
19	Entity Subscript No.	Optional, see Note 8
20	Sequence Number	DE line number, see Note 4

Parameter Data

<u>Index</u>	<u>Description</u>
1	Pointer to piping equipment definition (Entity 320) or external reference (Entity 416/5)
2	Translation in X direction (= 0.0)
3	Translation in Y direction (= 0.0)
4	Translation in Z direction (= 0.0)
5	Scale factor in X direction (= 1.0)
6	Scale factor in Y direction (= 1.0)
7	Scale factor in Z direction (= 1.0)
8	Type Flag (= 2)
9	Primary reference designator (= blank)
10	Pointer to directory entry of the primary reference designator text display template (= 0 or blank)
11	Number of piping equipment ports (= N)
12	Pointer to first piping equipment port (Entity 132)
.	.
.	.
.	.
N+11	Pointer to last piping equipment port (Entity 132)
N+12	Number of associativity instance pointers (= 0)

N+13
N+14

Number of property pointers (= 1)
Pointer to unmodified piping equipment attribute table instance (Entity
422/0)

4.2.10.2 Unmodified Piping Equipment Model Space Location and Orientation (Entity 124)

Directory Entry

<u>Field#</u>	<u>Field Name</u>	<u>Description</u>
1	Entity Type Number	124
2	Parameter Data	Pointer to corresponding PD record, see Note 1
3	Structure	0 or blank
4	Line Font Pattern	0 or blank
5	Level	0 or blank
6	View	0 or blank
7	Transformation Matrix	0 or blank
8	Label Pointer	0 or blank
9A	Blank Status	00
9B	Subordinate Switch	00
9C	Entity Use	00
9D	Hierarchy	00
10	Sequence Number	DE line number, see Note 2
11	Entity Type Number	124
12	Line Weight	0 or blank
13	Color Number	0 or blank
14	Parameter Line Count	Number of lines in PD record, see Note 3
15	Form Number	0 or 1
16	Reserved	Blank
17	Reserved	Blank
18	Entity Label	Optional, see Note 7
19	Entity Subscript No.	Optional, see Note 8
20	Sequence Number	DE line number, see Note 4

Parameter Data

<u>Index</u>	<u>Description</u>
1-3	First row of rotation matrix which defines unmodified piping equipment orientation in model space
4	X coordinate of unmodified piping equipment location in model space
5-7	Second row of rotation matrix which defines unmodified piping equipment orientation in model space
8	Y coordinate of unmodified piping equipment location in model space
9-11	Third row of rotation matrix which defines unmodified piping equipment orientation in model space
12	Z coordinate of unmodified piping equipment location in model space
13	Number of associativity instance pointers (= 0 or blank)
14	Number of property pointers (= 0 or blank)

4.2.10.3 Piping Equipment Definition External Reference (Entity 416, Form 5)

Directory Entry

<u>Field#</u>	<u>Field Name</u>	<u>Description</u>
1	Entity Type Number	416
2	Parameter Data	Pointer to corresponding PD record, see Note 1
3	Structure	0 or blank
4	Line Font Pattern	0 or blank
5	Level	0 or blank
6	View	0 or blank
7	Transformation Matrix	0 or blank
8	Label Pointer	0 or blank
9A	Blank Status	00
9B	Subordinate Switch	00
9C	Entity Use	04
9D	Hierarchy	00
10	Sequence Number	DE line number, see Note 2
11	Entity Type Number	416
12	Line Weight	0 or blank
13	Color Number	0 or blank
14	Parameter Line Count	Number of lines in PD record, see Note 3
15	Form Number	5
16	Reserved	Blank
17	Reserved	Blank
18	Entity Label	Optional, see Note 7
19	Entity Subscript No.	Optional, see Note 8
20	Sequence Number	DE line number, see Note 4

Parameter Data

<u>Index</u>	<u>Description</u>
1	External reference entity symbolic name
2	Number of associativity instance pointers (= 0 or blank)
3	Number of property pointers (= 0 or blank)

4.2.10.4 Unmodified Piping Equipment Attributes (Entity 422, Form 0)

Directory Entry

<u>Field#</u>	<u>Field Name</u>	<u>Description</u>
1	Entity Type Number	422
2	Parameter Data	Pointer to corresponding PD record, see Note 1
3	Structure	Negative pointer to attribute definition, see Note 6
4	Line Font Pattern	0 or blank
5	Level	0 or blank
6	View	0 or blank
7	Transformation Matrix	0 or blank
8	Label Pointer	0 or blank
9A	Blank Status	00
9B	Subordinate Switch	00
9C	Entity Use	03
9D	Hierarchy	00
10	Sequence Number	DE line number, see Note 2
11	Entity Type Number	422
12	Line Weight	0 or blank
13	Color Number	0 or blank
14	Parameter Line Count	Number of lines in PD record, see Note 3
15	Form Number	0
16	Reserved	Blank
17	Reserved	Blank
18	Entity Label	Optional, see Note 7
19	Entity Subscript No.	Optional, see Note 8
20	Sequence Number	DE line number, see Note 4

Parameter Data

<u>Index</u>	<u>Description</u>
1	Piping object type value (AT = 17, ALT = 4)
2	Piping equipment identifier value (AT = 19, ALT = 4)
.	.
.	.
.	.
N	Last attribute value
N+1	Number of associativity instance pointers (= 0 or blank)
N+2	Number of property pointers (= 0 or blank)

4.2.10.5 Unmodified Piping Equipment Attributes Definition (Entity 322, Form 0)

Directory Entry

<u>Field#</u>	<u>Field Name</u>	<u>Description</u>
1	Entity Type Number	322
2	Parameter Data	Pointer to corresponding PD record, see Note 1
3	Structure	0 or blank
4	Line Font Pattern	0 or blank
5	Level	0 or blank
6	View	0 or blank
7	Transformation Matrix	0 or blank
8	Label Pointer	0 or blank
9A	Blank Status	00
9B	Subordinate Switch	00
9C	Entity Use	02
9D	Hierarchy	00
10	Sequence Number	DE line number, see Note 2
11	Entity Type Number	322
12	Line Weight	0 or blank
13	Color Number	0 or blank
14	Parameter Line Count	Number of lines in PD record, see Note 3
15	Form Number	0
16	Reserved	Blank
17	Reserved	Blank
18	Entity Label	Optional, see Note 7
19	Entity Subscript No.	Optional, see Note 8
20	Sequence Number	DE line number, see Note 4

Parameter Data

<u>Index</u>	<u>Description</u>
1	Attribute table name (= 27HUNMODIFIED PIPING EQUIPMENT)
2	Attribute list type (= 4)
3	Number of attributes in table (= N)
4	First attribute type (= 17)
5	First attribute value data type (= 3)
6	First attribute value count (= 1)
7	Second attribute type (= 19)
8	Second attribute value data type (= 3)
9	Second attribute value count (= 1)
.	.
.	.
.	.
N*3+1	Last attribute type
N*3+2	Last attribute value data type
N*3+3	Last attribute value count (AVC(N) = 1)
N*3+4	Number of associativity instance pointers (= 0 or blank)
N*3+5	Number of property pointers (= 0 or blank)

3D Piping AIM Figure 4-11. Modified piping equipment

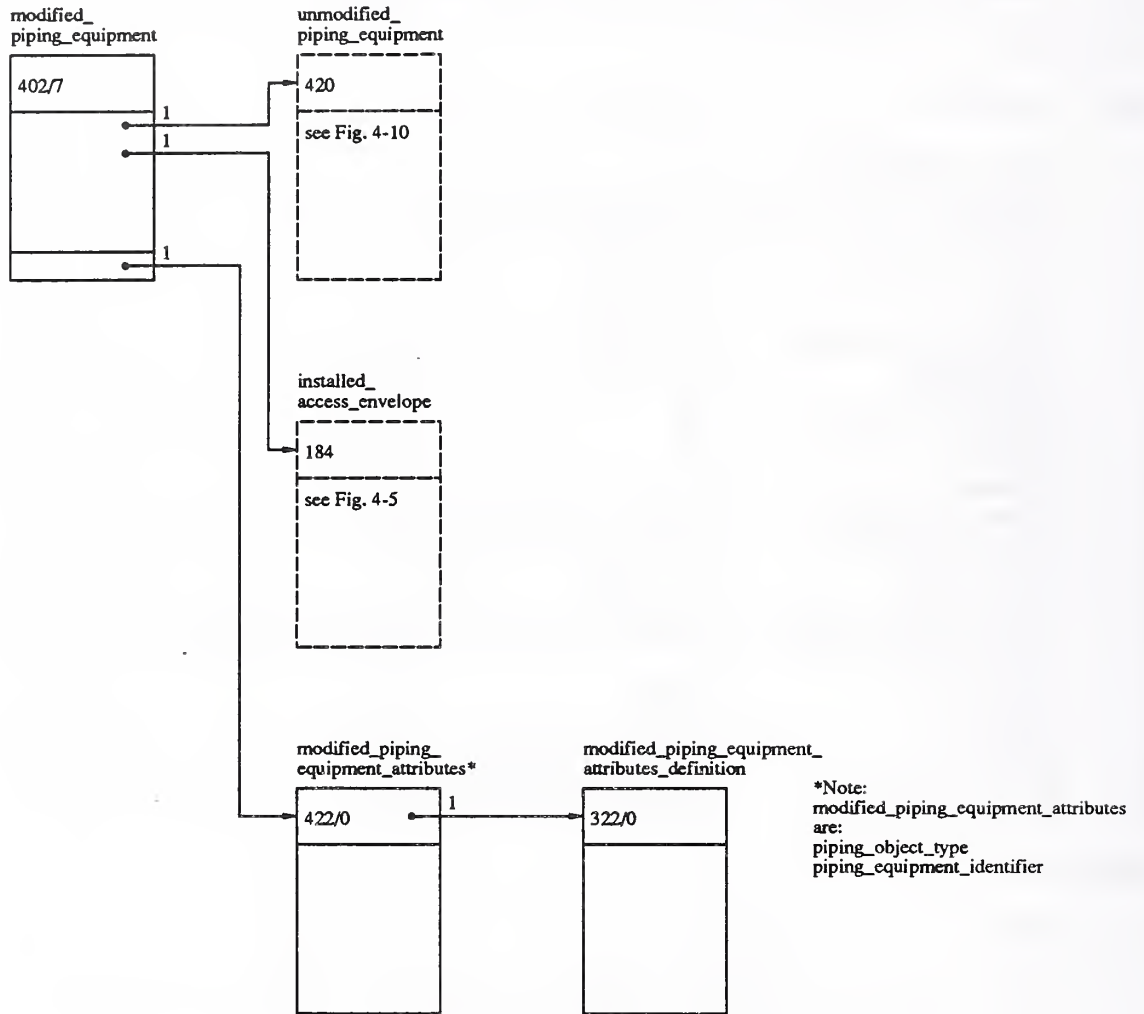

4.2.11 Modified Piping Equipment

4.2.11.1 Modified Piping Equipment Group Associativity (Entity 402, Form 7)

Directory Entry

<u>Field#</u>	<u>Field Name</u>	<u>Description</u>
1	Entity Type Number	402
2	Parameter Data	Pointer to corresponding PD record, see Note 1
3	Structure	0 or blank
4	Line Font Pattern	0 or blank
5	Level	0 or blank
6	View	0 or blank
7	Transformation Matrix	0 or blank
8	Label Pointer	0 or blank
9A	Blank Status	00
9B	Subordinate Switch	00
9C	Entity Use	03
9D	Hierarchy	00
10	Sequence Number	DE line number, see Note 2
11	Entity Type Number	402
12	Line Weight	0 or blank
13	Color Number	0 or blank
14	Parameter Line Count	Number of lines in PD record, see Note 3
15	Form Number	7
16	Reserved	Blank
17	Reserved	Blank
18	Entity Label	Optional, see Note 7
19	Entity Subscript No.	Optional, see Note 8
20	Sequence Number	DE line number, see Note 4

Parameter Data

<u>Index</u>	<u>Description</u>
1	Number of entity pointers (= N, $N \geq 2$)
2	Pointer to unmodified piping equipment (Entity 420)
3	Pointer to installed access envelope (Entity 184)
.	.
.	.
.	.
N+1	Number of associativity instance pointers (= 0 or blank)
N+2	Number of property pointers (= 1)
N+3	Pointer to modified piping equipment attribute table instance (Entity 422/0)

4.2.11.2 Modified Piping Equipment Attributes (Entity 422, Form 0)

Directory Entry

<u>Field#</u>	<u>Field Name</u>	<u>Description</u>
1	Entity Type Number	422
2	Parameter Data	Pointer to corresponding PD record, see Note 1
3	Structure	Negative pointer to attribute definition, see Note 6
4	Line Font Pattern	0 or blank
5	Level	0 or blank
6	View	0 or blank
7	Transformation Matrix	0 or blank
8	Label Pointer	0 or blank
9A	Blank Status	00
9B	Subordinate Switch	00
9C	Entity Use	03
9D	Hierarchy	00
10	Sequence Number	DE line number, see Note 2
11	Entity Type Number	422
12	Line Weight	0 or blank
13	Color Number	0 or blank
14	Parameter Line Count	Number of lines in PD record, see Note 3
15	Form Number	0
16	Reserved	Blank
17	Reserved	Blank
18	Entity Label	Optional, see Note 7
19	Entity Subscript No.	Optional, see Note 8
20	Sequence Number	DE line number, see Note 4

Parameter Data

<u>Index</u>	<u>Description</u>
1	Piping object type value (AT = 17, ALT = 4)
2	Piping equipment identifier value (AT = 19, ALT = 4)
.	.
.	.
.	.
N	Last attribute value
N+1	Number of associativity instance pointers (= 0 or blank)
N+2	Number of property pointers (= 0 or blank)

4.2.11.3 Modified Piping Equipment Attributes Definition (Entity 322, Form 0)

Directory Entry

<u>Field#</u>	<u>Field Name</u>	<u>Description</u>
1	Entity Type Number	322
2	Parameter Data	Pointer to corresponding PD record, see Note 1
3	Structure	0 or blank
4	Line Font Pattern	0 or blank
5	Level	0 or blank
6	View	0 or blank
7	Transformation Matrix	0 or blank
8	Label Pointer	0 or blank
9A	Blank Status	00
9B	Subordinate Switch	00
9C	Entity Use	02
9D	Hierarchy	00
10	Sequence Number	DE line number, see Note 2
11	Entity Type Number	322
12	Line Weight	0 or blank
13	Color Number	0 or blank
14	Parameter Line Count	Number of lines in PD record, see Note 3
15	Form Number	0
16	Reserved	Blank
17	Reserved	Blank
18	Entity Label	Optional, see Note 7
19	Entity Subscript No.	Optional, see Note 8
20	Sequence Number	DE line number, see Note 4

Parameter Data

<u>Index</u>	<u>Description</u>
1	Attribute table name (= 25HMODIFIED PIPING EQUIPMENT)
2	Attribute list type (= 4)
3	Number of attributes in table (= N)
4	First attribute type (= 17)
5	First attribute value data type (= 3)
6	First attribute value count (= 1)
7	Second attribute type (= 19)
8	Second attribute value data type (= 3)
9	Second attribute value count (= 1)
.	.
.	.
.	.
N*3+1	Last attribute type
N*3+2	Last attribute value data type
N*3+3	Last attribute value count (AVC(N) = 1)
N*3+4	Number of associativity instance pointers (= 0 or blank)
N*3+5	Number of property pointers (= 0 or blank)

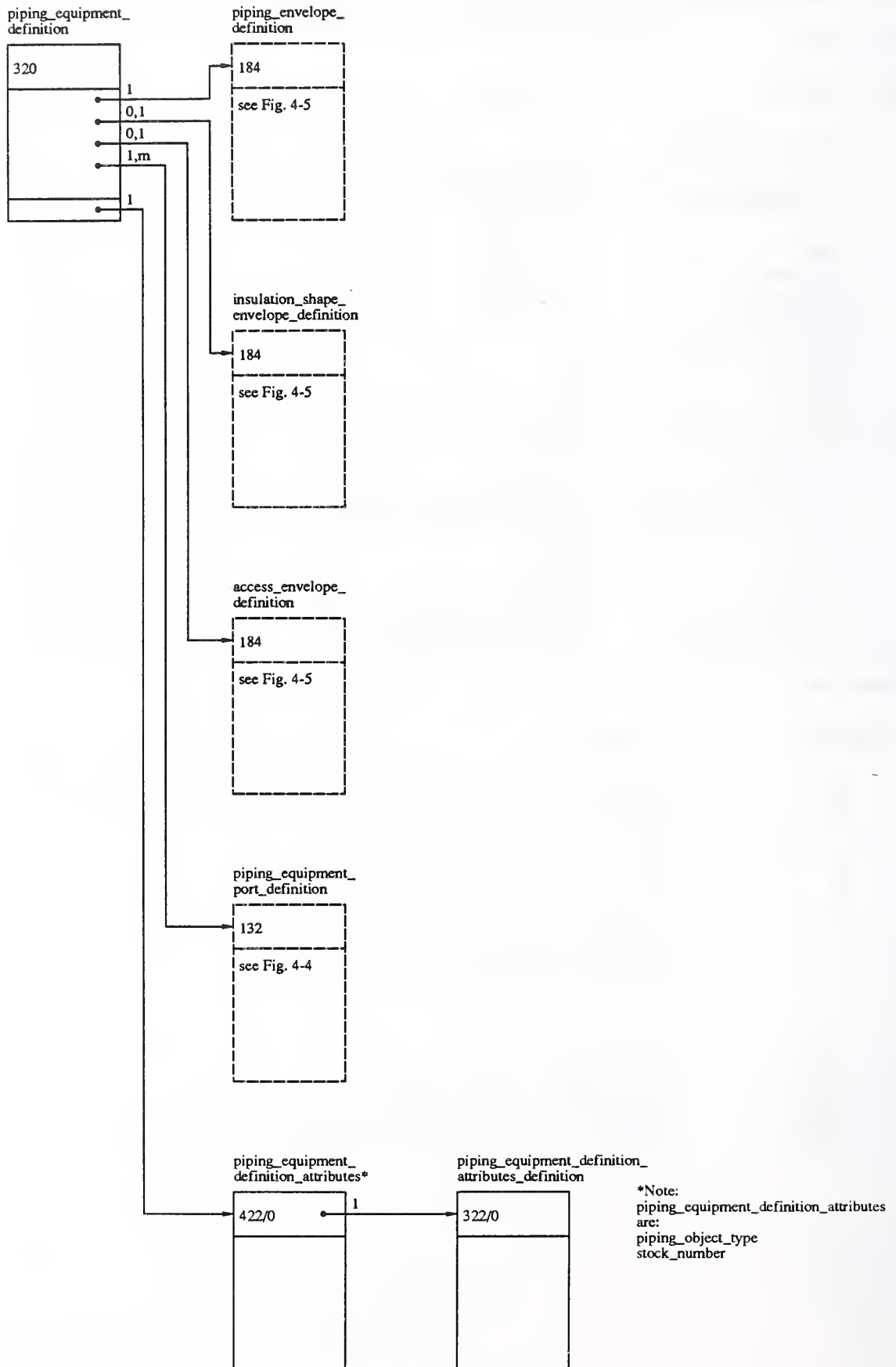

4.2.12 Piping Equipment Definition

4.2.12.1 Piping Equipment Definition Network Subfigure Definition (Entity 320)

Directory Entry

<u>Field#</u>	<u>Field Name</u>	<u>Description</u>
1	Entity Type Number	320
2	Parameter Data	Pointer to corresponding PD record, see Note 1
3	Structure	0 or blank
4	Line Font Pattern	0 or blank
5	Level	0 or blank
6	View	0 or blank
7	Transformation Matrix	Pointer to transformation matrix, see Note 5
8	Label Pointer	0 or blank
9A	Blank Status	00
9B	Subordinate Switch	00
9C	Entity Use	02
9D	Hierarchy	00
10	Sequence Number	DE line number, see Note 2
11	Entity Type Number	320
12	Line Weight	0 or blank
13	Color Number	0 or blank
14	Parameter Line Count	Number of lines in PD record, see Note 3
15	Form Number	0
16	Reserved	Blank
17	Reserved	Blank
18	Entity Label	Optional, see Note 7
19	Entity Subscript No.	Optional, see Note 8
20	Sequence Number	DE line number, see Note 4

Parameter Data

<u>Index</u>	<u>Description</u>
1	Depth of subfigure (= 0)
2	Stock number
3	Number of associated object envelope definitions (= NA, NA ≥ 1)
4	Pointer to piping envelope definition (Entity 184)
.	.
.	.
.	.
NA+3	Pointer to associated object envelope definition NA.
NA+4	Type flag (= 2)
NA+5	Primary reference designator (= 0 or blank)
NA+6	Pointer to the directory entry of the primary reference designator text display template (= 0 or blank)
NA+7	Number of associated piping equipment port definitions (= NC)
NA+8	Pointer to associated piping equipment port definition (Entity 132)
NA+NC+7	Pointer to associated piping equipment port definition NC (Entity 132)
NA+NC+8	Number of associativity instance pointers (= 0 or blank)
NA+NC+9	Number of property pointers (= 1)
NA+NC+10	Pointer to piping equipment definition attribute table instance(Entity422/0)

4.2.12.2 Piping Equipment Definition Attributes (Entity 422, Form 0)

Directory Entry

<u>Field#</u>	<u>Field Name</u>	<u>Description</u>
1	Entity Type Number	422
2	Parameter Data	Pointer to corresponding PD record, see Note 1
3	Structure	Negative pointer to attribute definition, see Note 6
4	Line Font Pattern	0 or blank
5	Level	0 or blank
6	View	0 or blank
7	Transformation Matrix	0 or blank
8	Label Pointer	0 or blank
9A	Blank Status	00
9B	Subordinate Switch	00
9C	Entity Use	03
9D	Hierarchy	00
10	Sequence Number	DE line number, see Note 2
11	Entity Type Number	422
12	Line Weight	0 or blank
13	Color Number	0 or blank
14	Parameter Line Count	Number of lines in PD record, see Note 3
15	Form Number	0
16	Reserved	Blank
17	Reserved	Blank
18	Entity Label	Optional, see Note 7
19	Entity Subscript No.	Optional, see Note 8
20	Sequence Number	DE line number, see Note 4

Parameter Data

<u>Index</u>	<u>Description</u>
1	Piping object type value (AT = 17, ALT = 4)
2	Stock number value (AT = 5, ALT = 4)
.	.
.	.
.	.
N	Last attribute value
N+1	Number of associativity instance pointers (= 0 or blank)
N+2	Number of property pointers (= 0 or blank)

4.2.12.3 Piping Equipment Definition Attributes Definition (Entity 322, Form 0)

Directory Entry

<u>Field#</u>	<u>Field Name</u>	<u>Description</u>
1	Entity Type Number	322
2	Parameter Data	Pointer to corresponding PD record, see Note 1
3	Structure	0 or blank
4	Line Font Pattern	0 or blank
5	Level	0 or blank
6	View	0 or blank
7	Transformation Matrix	0 or blank
8	Label Pointer	0 or blank
9A	Blank Status	00
9B	Subordinate Switch	00
9C	Entity Use	02
9D	Hierarchy	00
10	Sequence Number	DE line number, see Note 2
11	Entity Type Number	322
12	Line Weight	0 or blank
13	Color Number	0 or blank
14	Parameter Line Count	Number of lines in PD record, see Note 3
15	Form Number	0
16	Reserved	Blank
17	Reserved	Blank
18	Entity Label	Optional, see Note 7
19	Entity Subscript No.	Optional, see Note 8
20	Sequence Number	DE line number, see Note 4

Parameter Data

<u>Index</u>	<u>Description</u>
1	Attribute table name (= 27HPIPING EQUIPMENT DEFINITION)
2	Attribute list type (= 4)
3	Number of attributes in table (= N)
4	First attribute type (= 17)
5	First attribute value data type (= 3)
6	First attribute value count (= 1)
7	Second attribute type (= 5)
8	Second attribute value data type (= 3)
9	Second attribute value count (= 1)
.	.
.	.
.	.
N*3+1	Last attribute type
N*3+2	Last attribute value data type
N*3+3	Last attribute value count (AVC(N) = 1)
N*3+4	Number of associativity instance pointers (= 0 or blank)
N*3+5	Number of property pointers (= 0 or blank)

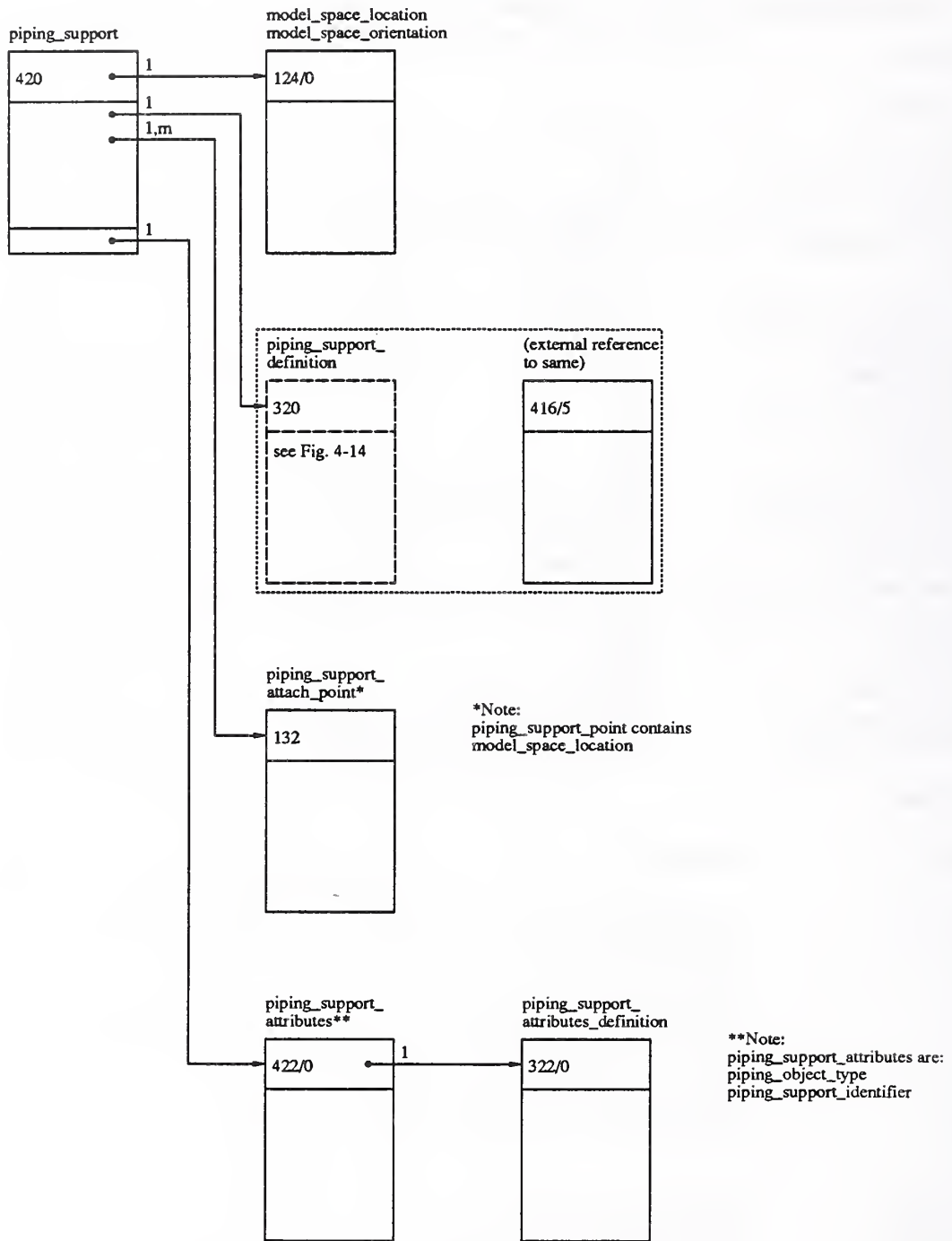

4.2.13 Piping Support

4.2.13.1 Piping Support Network Subfigure Instance (Entity 420)

Directory Entry

<u>Field#</u>	<u>Field Name</u>	<u>Description</u>
1	Entity Type Number	420
2	Parameter Data	Pointer to corresponding PD record, see Note 1
3	Structure	0 or blank
4	Line Font Pattern	0 or blank
5	Level	0 or blank
6	View	0 or blank
7	Transformation Matrix	Pointer to transformation matrix, see Note 5
8	Label Pointer	0 or blank
9A	Blank Status	00
9B	Subordinate Switch	00 or 02
9C	Entity Use	00
9D	Hierarchy	00
10	Sequence Number	DE line number, see Note 2
11	Entity Type Number	420
12	Line Weight	0 or blank
13	Color Number	0 or blank
14	Parameter Line Count	Number of lines in PD record, see Note 3
15	Form Number	0
16	Reserved	Blank
17	Reserved	Blank
18	Entity Label	Optional, see Note 7
19	Entity Subscript No.	Optional, see Note 8
20	Sequence Number	DE line number, see Note 4

Parameter Data

<u>Index</u>	<u>Description</u>
1	Pointer to piping support definition (Entity 320) or external reference (Entity 416/5)
2	Translation in X direction (= 0.0)
3	Translation in Y direction (= 0.0)
4	Translation in Z direction (= 0.0)
5	Scale factor in X direction (= 1.0)
6	Scale factor in Y direction (= 1.0)
7	Scale factor in Z direction (= 1.0)
8	Type Flag (= 2)
9	Primary reference designator (= blank)
10	Pointer to directory entry of the primary reference designator text display template (= 0 or blank)
11	Number of piping support attach points (= N)
12	Pointer to first piping support attach point (Entity 132)
.	.
.	.
.	.
N+11	Pointer to last piping support attach point (Entity 132)
N+12	Number of associativity instance pointers (= 0)

N+13
N+14

Number of property pointers (= 1)
Pointer to piping support attribute table instance (Entity 422/0)

4.2.13.2 Piping Support Model Space Location and Orientation (Entity 124)

Directory Entry

<u>Field#</u>	<u>Field Name</u>	<u>Description</u>
1	Entity Type Number	124
2	Parameter Data	Pointer to corresponding PD record, see Note 1
3	Structure	0 or blank
4	Line Font Pattern	0 or blank
5	Level	0 or blank
6	View	0 or blank
7	Transformation Matrix	0 or blank
8	Label Pointer	0 or blank
9A	Blank Status	00
9B	Subordinate Switch	00
9C	Entity Use	00
9D	Hierarchy	00
10	Sequence Number	DE line number, see Note 2
11	Entity Type Number	124
12	Line Weight	0 or blank
13	Color Number	0 or blank
14	Parameter Line Count	Number of lines in PD record, see Note 3
15	Form Number	0 or 1
16	Reserved	Blank
17	Reserved	Blank
18	Entity Label	Optional, see Note 7
19	Entity Subscript No.	Optional, see Note 8
20	Sequence Number	DE line number, see Note 4

Parameter Data

<u>Index</u>	<u>Description</u>
1-3	First row of rotation matrix which defines piping support orientation in model space
4	X coordinate of piping support location in model space
5-7	Second row of rotation matrix which defines piping equipment orientation in model space
8	Y coordinate of piping support location in model space
9-11	Third row of rotation matrix which defines piping support orientation in model space
12	Z coordinate of piping support location in model space
13	Number of associativity instance pointers (= 0 or blank)
14	Number of property pointers (= 0 or blank)

4.2.13.3 Piping Support Definition External Reference (Entity 416, Form 5)

Directory Entry

<u>Field#</u>	<u>Field Name</u>	<u>Description</u>
1	Entity Type Number	416
2	Parameter Data	Pointer to corresponding PD record, see Note 1
3	Structure	0 or blank
4	Line Font Pattern	0 or blank
5	Level	0 or blank
6	View	0 or blank
7	Transformation Matrix	0 or blank
8	Label Pointer	0 or blank
9A	Blank Status	00
9B	Subordinate Switch	00
9C	Entity Use	04
9D	Hierarchy	00
10	Sequence Number	DE line number, see Note 2
11	Entity Type Number	416
12	Line Weight	0 or blank
13	Color Number	0 or blank
14	Parameter Line Count	Number of lines in PD record, see Note 3
15	Form Number	5
16	Reserved	Blank
17	Reserved	Blank
18	Entity Label	Optional, see Note 7
19	Entity Subscript No.	Optional, see Note 8
20	Sequence Number	DE line number, see Note 4

Parameter Data

<u>Index</u>	<u>Description</u>
1	External reference entity symbolic name
2	Number of associativity instance pointers (= 0 or blank)
3	Number of property pointers (= 0 or blank)

4.2.13.4 Piping Support Attach Point (Entity 132)

Directory Entry

<u>Field#</u>	<u>Field Name</u>	<u>Description</u>
1	Entity Type Number	132
2	Parameter Data	Pointer to corresponding PD record, see Note 1
3	Structure	0 or blank
4	Line Font Pattern	0 or blank
5	Level	0 or blank
6	View	0 or blank
7	Transformation Matrix	Pointer to tranformation matrix, see Note 5
8	Label Pointer	0 or blank
9A	Blank Status	00
9B	Subordinate Swith	02
9C	Entity Use	04
9D	Hierarchy	00
10	Sequence Number	DE line number, see Note 2
11	Entity Type Number	132
12	Line Weight	0 or blank
13	Color Number	0 or blank
14	Parameter Line Count	Number of lines in PD record, see Note 3
15	Form Number	0
16	Reserved	Blank
17	Reserved	Blank
18	Entity Label	Optional, see Note 7
19	Entity Subscript No.	Optional, see Note 8
20	Sequence Number	DE line number, see Note 4

Parameter Data

<u>Index</u>	<u>Description</u>
1	X coordinate in model space location
2	Y coordinate in model space location
3	Z coordinate in model space location
4	Pointer to the display symbol geometry (= 0 or blank)
5	Type flag (= 2)
6	Function flag (= 2)
7	Function identifier (= blank)
8	Pointer to text display (= 0 or blank)
9	Function name (= blank)
10	Pointer to text display (= 0 or blank)
11	Unique connect point identifier (= 0 or blank)
12	Connect point function code (= 0 or blank)
13	Swap flag (= 0 or blank)
14	Pointer to owner piping support (Entity 420)
15	Number of associativity instance pointers (= 0 or blank)
16	Number of property pointers (= 0 or blank)

4.2.13.5 Piping Support Attributes (Entity 422, Form 0)

Directory Entry

<u>Field#</u>	<u>Field Name</u>	<u>Description</u>
1	Entity Type Number	422
2	Parameter Data	Pointer to corresponding PD record, see Note 1
3	Structure	Negative pointer to attribute definition, see Note 6
4	Line Font Pattern	0 or blank
5	Level	0 or blank
6	View	0 or blank
7	Transformation Matrix	0 or blank
8	Label Pointer	0 or blank
9A	Blank Status	00
9B	Subordinate Switch	00
9C	Entity Use	03
9D	Hierarchy	00
10	Sequence Number	DE line number, see Note 2
11	Entity Type Number	422
12	Line Weight	0 or blank
13	Color Number	0 or blank
14	Parameter Line Count	Number of lines in PD record, see Note 3
15	Form Number	0
16	Reserved	Blank
17	Reserved	Blank
18	Entity Label	Optional, see Note 7
19	Entity Subscript No.	Optional, see Note 8
20	Sequence Number	DE line number, see Note 4

Parameter Data

<u>Index</u>	<u>Description</u>
1	Piping object type value (AT = 17, ALT = 4)
2	Piping support identifier value (AT = 19, ALT = 4)
.	.
.	.
.	.
N	Last attribute value
N+1	Number of associativity instance pointers (= 0 or blank)
N+2	Number of property pointers (= 0 or blank)

4.2.13.6 Piping Support Attributes Definition (Entity 322, Form 0)

Directory Entry

<u>Field#</u>	<u>Field Name</u>	<u>Description</u>
1	Entity Type Number	322
2	Parameter Data	Pointer to corresponding PD record, see Note 1
3	Structure	0 or blank
4	Line Font Pattern	0 or blank
5	Level	0 or blank
6	View	0 or blank
7	Transformation Matrix	0 or blank
8	Label Pointer	0 or blank
9A	Blank Status	00
9B	Subordinate Switch	00
9C	Entity Use	02
9D	Hierarchy	00
10	Sequence Number	DE line number, see Note 2
11	Entity Type Number	322
12	Line Weight	0 or blank
13	Color Number	0 or blank
14	Parameter Line Count	Number of lines in PD record, see Note 3
15	Form Number	0
16	Reserved	Blank
17	Reserved	Blank
18	Entity Label	Optional, see Note 7
19	Entity Subscript No.	Optional, see Note 8
20	Sequence Number	DE line number, see Note 4

Parameter Data

<u>Index</u>	<u>Description</u>
1	Attribute table name (= 14HPIPING SUPPORT)
2	Attribute list type (= 4)
3	Number of attributes in table (= N)
4	First attribute type (= 17)
5	First attribute value data type (= 3)
6	First attribute value count (= 1)
7	Second attribute type (= 19)
8	Second attribute value data type (= 3)
9	Second attribute value count (= 1)
.	.
.	.
.	.
N*3+1	Last attribute type
N*3+2	Last attribute value data type
N*3+3	Last attribute value count (AVC(N) = 1)
N*3+4	Number of associativity instance pointers (= 0 or blank)
N*3+5	Number of property pointers (= 0 or blank)

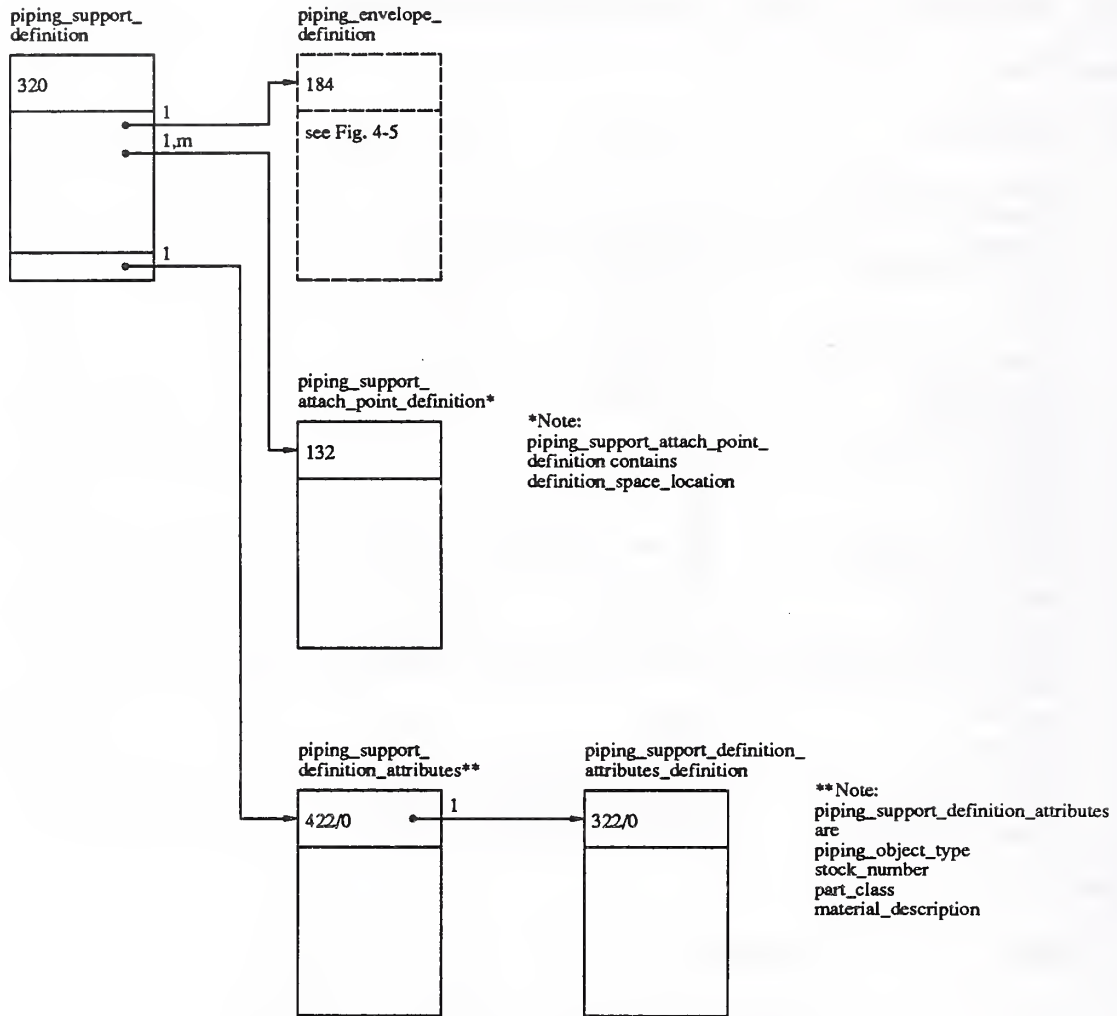

4.2.14 Piping Support Definition

4.2.14.1 Piping Support Network Subfigure Definition (Entity 320)

Directory Entry

<u>Field#</u>	<u>Field Name</u>	<u>Description</u>
1	Entity Type Number	320
2	Parameter Data	Pointer to corresponding PD record, see Note 1
3	Structure	0 or blank
4	Line Font Pattern	0 or blank
5	Level	0 or blank
6	View	0 or blank
7	Transformation Matrix	Pointer to transformation matrix, see Note 5
8	Label Pointer	0 or blank
9A	Blank Status	00
9B	Subordinate Switch	00
9C	Entity Use	02
9D	Hierarchy	00
10	Sequence Number	DE line number, see Note 2
11	Entity Type Number	320
12	Line Weight	0 or blank
13	Color Number	0 or blank
14	Parameter Line Count	Number of lines in PD record, see Note 3
15	Form Number	0
16	Reserved	Blank
17	Reserved	Blank
18	Entity Label	Optional, see Note 7
19	Entity Subscript No.	Optional, see Note 8
20	Sequence Number	DE line number, see Note 4

Parameter Data

<u>Index</u>	<u>Description</u>
1	Depth of subfigure (= 0)
2	Stock number
3	Pointer to piping envelope definition (Entity 184)
.	.
.	.
.	.
NA+3	Pointer to associated object envelope definition NA.
NA+4	Type flag (= 2)
NA+5	Primary reference designator (= 0 or blank)
NA+6	Pointer to the directory entry of the primary reference designator text display template (= 0 or blank)
NA+7	Number of associated piping support attach point definitions (= NC)
NA+8	Pointer to associated piping support attach point definition (Entity 132)
NA+NC+7	Pointer to associated piping support attach point definition NC (Entity 132)
NA+NC+8	Number of associativity instance pointers (= 0 or blank)
NA+NC+9	Number of property pointers (= 1)
NA+NC+10	Pointer to piping support definition attribute table instance (Entity 422/0)

4.2.14.2 Piping Support Attach Point Definition (Entity 132)

Directory Entry

<u>Field#</u>	<u>Field Name</u>	<u>Description</u>
1	Entity Type Number	132
2	Parameter Data	Pointer to corresponding PD record, see Note 1
3	Structure	0 or blank
4	Line Font Pattern	0 or blank
5	Level	0 or blank
6	View	0 or blank
7	Transformation Matrix	Pointer to tranformation matrix, see Note 5
8	Label Pointer	0 or blank
9A	Blank Status	00
9B	Subordinate Switch	02
9C	Entity Use	04
9D	Hierarchy	00
10	Sequence Number	DE line number, see Note 2
11	Entity Type Number	132
12	Line Weight	0 or blank
13	Color Number	0 or blank
14	Parameter Line Count	Number of lines in PD record, see Note 3
15	Form Number	0
16	Reserved	Blank
17	Reserved	Blank
18	Entity Label	Optional, see Note 7
19	Entity Subscript No.	Optional, see Note 8
20	Sequence Number	DE line number, see Note 4

Parameter Data

<u>Index</u>	<u>Description</u>
1	X coordinate in model space location
2	Y coordinate in model space location
3	Z coordinate in model space location
4	Pointer to the display symbol geometry (= 0 or blank)
5	Type flag (= 2)
6	Function flag (= 2)
7	Function Identifier (= blank)
8	Pointer to text display (= 0 or blank)
9	Function name (= blank)
10	Pointer to text display (= 0 or blank)
11	Unique connect point identifier (= 0 or blank)
12	Connect point function code (= 0 or blank)
13	Swap flag (= 0 or blank)
14	Pointer to owner piping support definition (Entity 420)
15	Number of associativity instance pointers (= 0 or blank)
16	Number of property pointers (= 0 or blank)

4.2.14.3 Piping Support Definition Attributes (Entity 422, Form 0)

Directory Entry

<u>Field#</u>	<u>Field Name</u>	<u>Description</u>
1	Entity Type Number	422
2	Parameter Data	Pointer to corresponding PD record, see Note 1
3	Structure	Negative pointer to attribute definition, see Note 6
4	Line Font Pattern	0 or blank
5	Level	0 or blank
6	View	0 or blank
7	Transformation Matrix	0 or blank
8	Label Pointer	0 or blank
9A	Blank Status	00
9B	Subordinate Switch	00
9C	Entity Use	03
9D	Hierarchy	00
10	Sequence Number	DE line number, see Note 2
11	Entity Type Number	422
12	Line Weight	0 or blank
13	Color Number	0 or blank
14	Parameter Line Count	Number of lines in PD record, see Note 3
15	Form Number	0
16	Reserved	Blank
17	Reserved	Blank
18	Entity Label	Optional, see Note 7
19	Entity Subscript No.	Optional, see Note 8
20	Sequence Number	DE line number, see Note 4

Parameter Data

<u>Index</u>	<u>Description</u>
1	Piping object type value (AT = 17, ALT = 4)
2	Stock number value (AT = 5, ALT = 4)
3	Part class value (AT = 36, ALT = 4)
4	Material description value (AT = 50, ALT = 4)
.	.
.	.
.	.
N	Last attribute value
N+1	Number of associativity instance pointers (= 0 or blank)
N+2	Number of property pointers (= 0 or blank)

4.2.14.4 Piping Support Definition Attributes Definition (Entity 322, Form 0)

Directory Entry

<u>Field#</u>	<u>Field Name</u>	<u>Description</u>
1	Entity Type Number	322
2	Parameter Data	Pointer to corresponding PD record, see Note 1
3	Structure	0 or blank
4	Line Font Pattern	0 or blank
5	Level	0 or blank
6	View	0 or blank
7	Transformation Matrix	0 or blank
8	Label Pointer	0 or blank
9A	Blank Status	00
9B	Subordinate Switch	00
9C	Entity Use	02
9D	Hierarchy	00
10	Sequence Number	DE line number, see Note 2
11	Entity Type Number	322
12	Line Weight	0 or blank
13	Color Number	0 or blank
14	Parameter Line Count	Number of lines in PD record, see Note 3
15	Form Number	0
16	Reserved	Blank
17	Reserved	Blank
18	Entity Label	Optional, see Note 7
19	Entity Subscript No.	Optional, see Note 8
20	Sequence Number	DE line number, see Note 4

Parameter Data

<u>Index</u>	<u>Description</u>
1	Attribute table name (= 25HPIPING SUPPORT DEFINITION)
2	Attribute list type (= 4)
3	Number of attributes in table (= N)
4	First attribute type (= 17)
5	First attribute value data type (= 3)
6	First attribute value count (= 1)
7	Second attribute type (= 5)
8	Second attribute value data type (= 3)
9	Second attribute value count (= 1)
10	Third attribute type (= 36)
11	Third attribute value data type (= 3)
12	Third attribute value count (= 1)
13	Fourth attribute type (= 50)
14	Fourth attribute value data type (= 3)
15	Fourth attribute value count (= 1)
.	.
.	.
.	.
N*3+1	Last attribute type
N*3+2	Last attribute value data type
N*3+3	Last attribute value count (AVC(N) = 1)

N*3+4
N*3+5

Number of associativity instance pointers (= 0 or blank)
Number of property pointers (= 0 or blank)

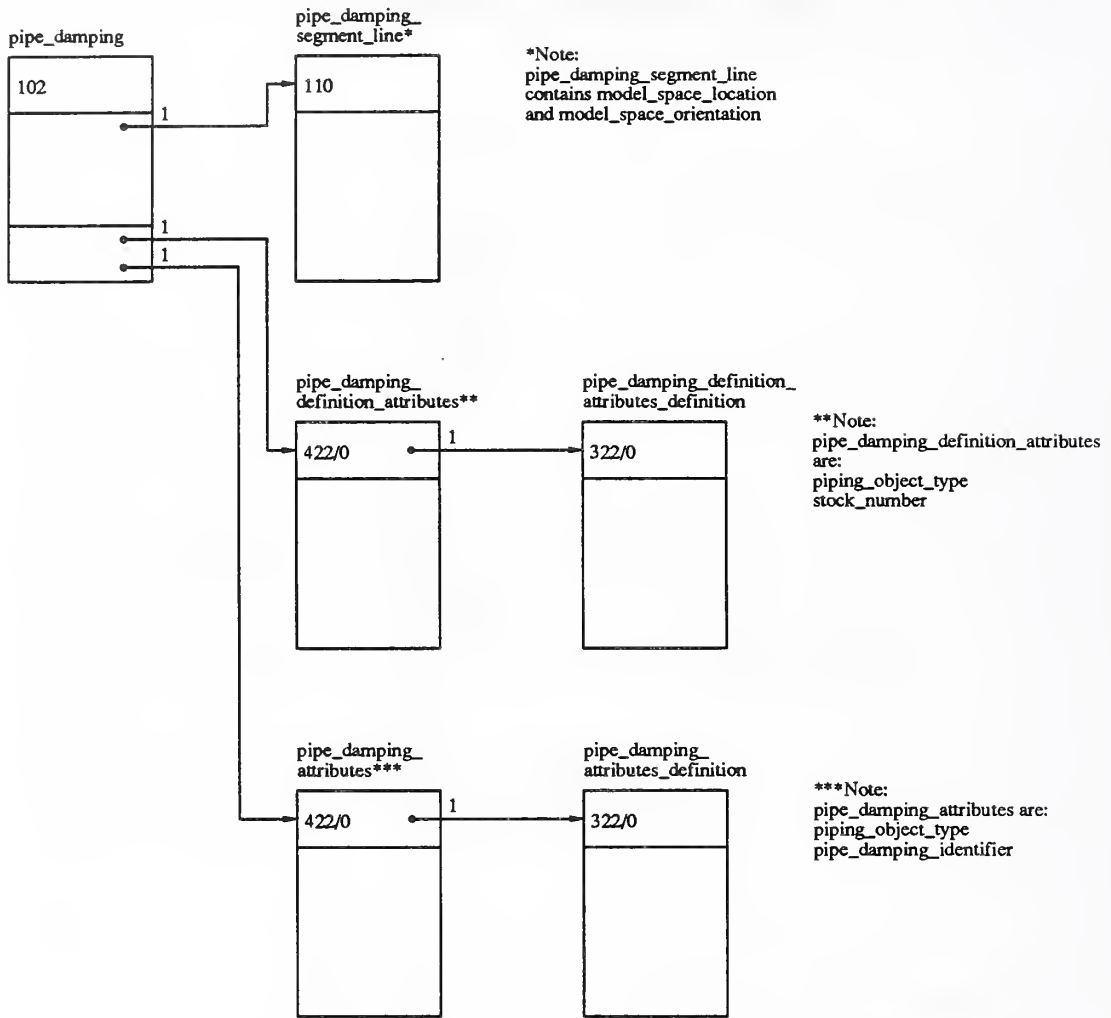

4.2.15 Pipe Damping

4.2.15.1 Pipe Damping Composite Curve (Entity 102)

Directory Entry

<u>Field#</u>	<u>Field Name</u>	<u>Description</u>
1	Entity Type Number	102
2	Parameter Data	Pointer to corresponding PD record, see Note 1
3	Structure	0 or blank
4	Line Font Pattern	0 or blank
5	Level	0 or blank
6	View	0 or blank
7	Transformation Matrix	0 or blank
8	Label Pointer	0 or blank
9A	Blank Status	00
9B	Subordinate Switch	02
9C	Entity Use	00
9D	Hierarchy	00
10	Sequence Number	DE line number, see Note 2
11	Entity Type Number	102
12	Line Weight	0 or blank
13	Color Number	0 or blank
14	Parameter Line Count	Number of lines in PD record, see Note 3
15	Form Number	0
16	Reserved	Blank
17	Reserved	Blank
18	Entity Label	Optional, see Note 7
19	Entity Subscript No.	Optional, see Note 8
20	Sequence Number	DE line number, see Note 4

Parameter Data

<u>Index</u>	<u>Description</u>
1	Number of entity pointers (= 1)
2	Pointer to pipe damping segment line (Entity 110)
3	Number of associativity instance pointers (= 0)
4	Number of property pointers (= 2)
5	Pointer to pipe damping attribute table instance (Entity 422/0)
6	Pointer to pipe damping definition attribute table instance (Entity 422/0)

4.2.15.2 Pipe Damping Segment Line (Entity 110)

Directory Entry

<u>Field#</u>	<u>Field Name</u>	<u>Description</u>
1	Entity Type Number	110
2	Parameter Data	Pointer to corresponding PD record, see Note 1
3	Structure	0 or blank
4	Line Font Pattern	0 or blank
5	Level	0 or blank
6	View	0 or blank
7	Transformation Matrix	Pointer to transformation matrix, see Note 5
8	Label Pointer	0 or blank
9A	Blank Status	00
9B	Subordinate Switch	01
9C	Entity Use	00
9D	Hierarchy	00
10	Sequence Number	DE line number, see Note 2
11	Entity Type Number	110
12	Line Weight	0 or blank
13	Color Number	0 or blank
14	Parameter Line Count	Number of lines in PD record, see Note 3
15	Form Number	0
16	Reserved	Blank
17	Reserved	Blank
18	Entity Label	Optional, see Note 7
19	Entity Subscript No.	Optional, see Note 8
20	Sequence Number	DE line number, see Note 4

Parameter Data

<u>Index</u>	<u>Description</u>
1	Start point x coordinate in model space
2	Start point y coordinate in model space
3	Start point z coordinate in model space
4	End point x coordinate in model space
5	End point y coordinate in model space
6	End point z coordinate in model space
7	Number of associativity instance pointers (0 or blank)
8	Number of property pointers (= 0 or blank)

4.2.15.3 Pipe Damping Definition Attributes (Entity 422, Form 0)

Directory Entry

<u>Field#</u>	<u>Field Name</u>	<u>Description</u>
1	Entity Type Number	422
2	Parameter Data	Pointer to corresponding PD record, see Note 1
3	Structure	Negative pointer to attribute definition, see Note 6
4	Line Font Pattern	0 or blank
5	Level	0 or blank
6	View	0 or blank
7	Transformation Matrix	0 or blank
8	Label Pointer	0 or blank
9A	Blank Status	00
9B	Subordinate Switch	00
9C	Entity Use	03
9D	Hierarchy	00
10	Sequence Number	DE line number, see Note 2
11	Entity Type Number	422
12	Line Weight	0 or blank
13	Color Number	0 or blank
14	Parameter Line Count	Number of lines in PD record, see Note 3
15	Form Number	0
16	Reserved	Blank
17	Reserved	Blank
18	Entity Label	Optional, see Note 7
19	Entity Subscript No.	Optional, see Note 8
20	Sequence Number	DE line number, see Note 4

Parameter Data

<u>Index</u>	<u>Description</u>
1	Piping object type value (AT = 17, ALT = 4)
2	Stock number value (AT = 5, ALT = 4)
.	.
.	.
.	.
N	Last attribute value
N+1	Number of associativity instance pointers(= 0 or blank)
N+2	Number of property pointers (= 0 or blank)

4.2.15.4 Pipe Damping Definition Attributes Definition (Entity 322, Form 0)

Directory Entry

<u>Field#</u>	<u>Field Name</u>	<u>Description</u>
1	Entity Type Number	322
2	Parameter Data	Pointer to corresponding PD record, see Note 1
3	Structure	0 or blank
4	Line Font Pattern	0 or blank
5	Level	0 or blank
6	View	0 or blank
7	Transformation Matrix	0 or blank
8	Label Pointer	0 or blank
9A	Blank Status	00
9B	Subordinate Switch	00
9C	Entity Use	02
9D	Hierarchy	00
10	Sequence Number	DE line number, see Note 2
11	Entity Type Number	322
12	Line Weight	0 or blank
13	Color Number	0 or blank
14	Parameter Line Count	Number of lines in PD record, see Note 3
15	Form Number	0
16	Reserved	Blank
17	Reserved	Blank
18	Entity Label	Optional, see Note 7
19	Entity Subscript No.	Optional, see Note 8
20	Sequence Number	DE line number, see Note 4

Parameter Data

<u>Index</u>	<u>Description</u>
1	Attribute table name (= 23HPIPE DAMPING DEFINITION)
2	Attribute list type (= 4)
3	Number of attributes in table (= N)
4	First attribute type (= 17)
5	First attribute value data type (= 3)
6	First attribute value count (= 1)
7	Second attribute type (= 5)
8	Second attribute value data type (= 3)
9	Second attribute value count (= 1)
.	.
.	.
.	.
N*3+1	Last attribute type
N*3+2	Last attribute value data type
N*3+3	Last attribute value count (AVC(N) = 1)
N*3+4	Number of associativity instance pointers (= 0 or blank)
N*3+5	Number of property pointers (= 0 or blank)

4.2.15.5 Pipe Damping Attributes (Entity 422, Form 0)

Directory Entry

<u>Field#</u>	<u>Field Name</u>	<u>Description</u>
1	Entity Type Number	422
2	Parameter Data	Pointer to corresponding PD record, see Note 1
3	Structure	Negative pointer to attribute definition, see Note 6
4	Line Font Pattern	0 or blank
5	Level	0 or blank
6	View	0 or blank
7	Transformation Matrix	0 or blank
8	Label Pointer	0 or blank
9A	Blank Status	00
9B	Subordinate Switch	00
9C	Entity Use	03
9D	Hierarchy	00
10	Sequence Number	DE line number, see Note 2
11	Entity Type Number	422
12	Line Weight	0 or blank
13	Color Number	0 or blank
14	Parameter Line Count	Number of lines in PD record, see Note 3
15	Form Number	0
16	Reserved	Blank
17	Reserved	Blank
18	Entity Label	Optional, see Note 7
19	Entity Subscript No.	Optional, see Note 8
20	Sequence Number	DE line number, see Note 4

Parameter Data

<u>Index</u>	<u>Description</u>
1	Piping object type value (AT = 17, ALT = 4)
2	Pipe damping identifier value (AT = 19, ALT = 4)
.	.
.	.
.	.
N	Last attribute value
N+1	Number of associativity instance pointers (= 0 or blank)
N+2	Number of property pointers (= 0 or blank)

4.2.15.6 Pipe Damping Attributes Definition (Entity 322, Form 0)

Directory Entry

<u>Field#</u>	<u>Field Name</u>	<u>Description</u>
1	Entity Type Number	322
2	Parameter Data	Pointer to corresponding PD record, see Note 1
3	Structure	0 or blank
4	Line Font Pattern	0 or blank
5	Level	0 or blank
6	View	0 or blank
7	Transformation Matrix	0 or blank
8	Label Pointer	0 or blank
9A	Blank Status	00
9B	Subordinate Switch	00
9C	Entity Use	02
9D	Hierarchy	00
10	Sequence Number	DE line number, see Note 2
11	Entity Type Number	322
12	Line Weight	0 or blank
13	Color Number	0 or blank
14	Parameter Line Count	Number of lines in PD record, see Note 3
15	Form Number	0
16	Reserved	Blank
17	Reserved	Blank
18	Entity Label	Optional, see Note 7
19	Entity Subscript No.	Optional, see Note 8
20	Sequence Number	DE line number, see Note 4

Parameter Data

<u>Index</u>	<u>Description</u>
1	Attribute table name (= 12HPIPE DAMPING)
2	Attribute list type (= 4)
3	Number of attributes in table (= N)
4	First attribute type (= 17)
5	First attribute value data type (= 3)
6	First attribute value count (= 1)
7	Second attribute type (= 19)
8	Second attribute value data type (= 3)
9	Second attribute value count (= 1)
.	.
.	.
.	.
N*3+1	Last attribute type
N*3+2	Last attribute value data type
N*3+3	Last attribute value count (AVC(N) = 1)
N*3+4	Number of associativity instance pointers (= 0 or blank)
N*3+5	Number of property pointers (= 0 or blank)

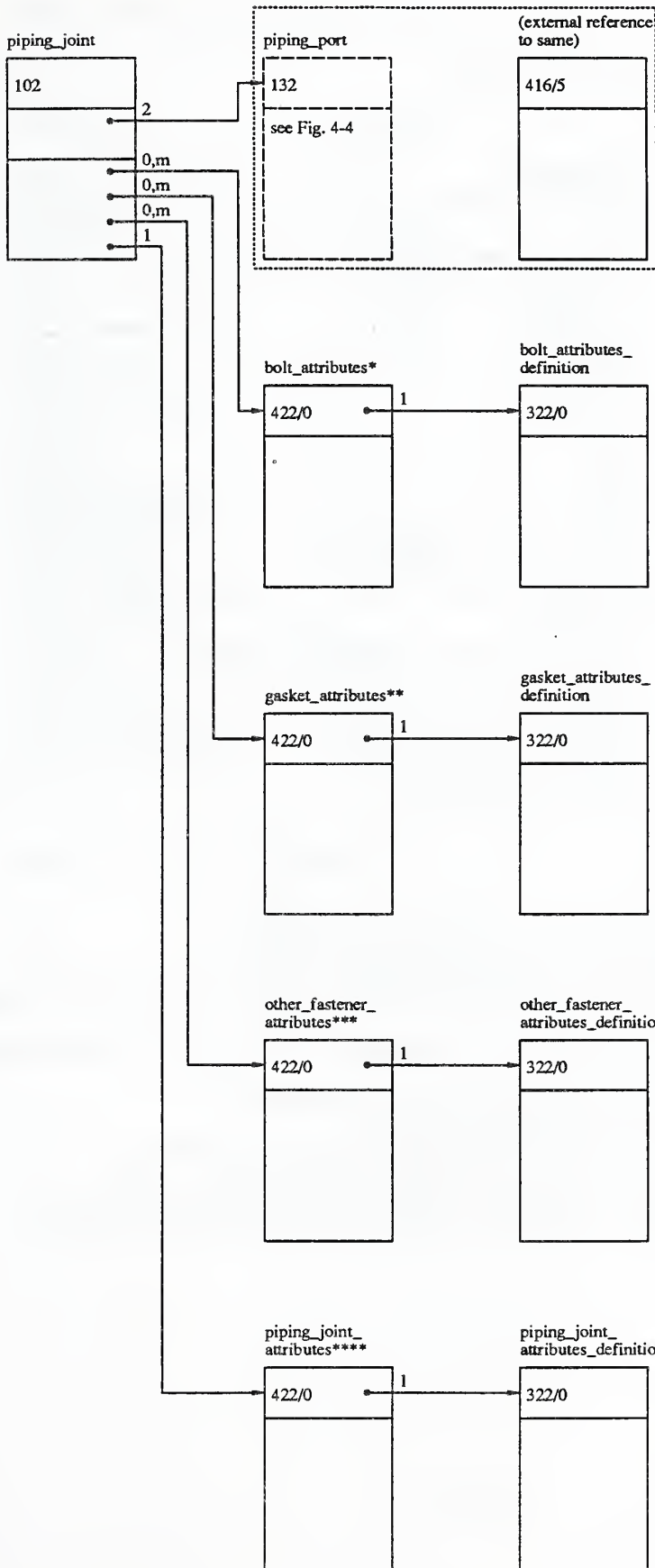

*Note:
 bolt_attributes are:
 piping_object_type
 fastener_type
 stock_number
 material_description
 bolt_type
 bolt_length
 bolt_length_units
 bolt_diameter
 bolt_diameter_units
 quantity
 quantity_units

**Note:
 gasket_attributes are:
 piping_object_type
 fastener_type
 stock_number
 material_description
 gasket_thickness
 gasket_thickness_units

***Note:
 other_fastener_attributes are:
 piping_object_type
 fastener_type
 stock_number
 material_description
 quantity
 quantity_units

****Note:
 piping_joint_attributes are:
 piping_object_type
 joint_identification_number
 joint_fabrication_location

4.2.16 Piping Joint

4.2.16.1 Piping Joint Composite Curve (Entity 102)

Directory Entry

<u>Field#</u>	<u>Field Name</u>	<u>Description</u>
1	Entity Type Number	102
2	Parameter Data	Pointer to corresponding PD record, see Note 1
3	Structure	0 or blank
4	Line Font Pattern	0 or blank
5	Level	0 or blank
6	View	0 or blank
7	Transformation Matrix	0 or blank
8	Label Pointer	0 or blank
9A	Blank Status	00
9B	Subordinate Switch	00
9C	Entity Use	00
9D	Hierarchy	00
10	Sequence Number	DE line number, see Note 2
11	Entity Type Number	102
12	Line Weight	0 or blank
13	Color Number	0 or blank
14	Parameter Line Count	Number of lines in PD record, see Note 3
15	Form Number	0
16	Reserved	Blank
17	Reserved	Blank
18	Entity Label	Optional, see Note 7
19	Entity Subscript No.	Optional, see Note 8
20	Sequence Number	DE line number, see Note 4

Parameter Data

<u>Index</u>	<u>Description</u>
1	Number of entity pointers (= 2)
2	Pointer to piping port connect point (Entity 132) or external reference (Entity 416/5)
3	Pointer to piping port connect point (Entity 132) or external reference (Entity 416/5)
4	Number of associativity instance pointers (= 0)
5	Number of property pointers (= Z)
6	Pointer to bolt attribute table instance (Entity 422/0)
7	Pointer to gasket attribute table instance (Entity 422/0)
8	Pointer to other fastener attribute table instance (Entity 422/0)
9	Pointer to piping joint attribute table instance (Entity 422/

4.2.16.2 Piping Port External Reference (Entity 416, Form 5)

Directory Entry

<u>Field #</u>	<u>Field Name</u>	<u>Description</u>
1	Entity Type Number	416
2	Parameter Data	Pointer to corresponding PD record, see Note 1
3	Structure	0 or blank
4	Line Font Pattern	0 or blank
5	Level	0 or blank
6	View	0 or blank
7	Transformation Matrix	0 or blank
8	Label Pointer	0 or blank
9A	Blank Status	00
9B	Subordinate Switch	00
9C	Entity Use	04
9D	Hierarchy	00
10	Sequence Number	DE line number, see Note 2
11	Entity Type Number	416
12	Line Weight	0 or blank
13	Color Number	0 or blank
14	Parameter Line Count	Number of lines in PD record, see Note 3
15	Form Number	5
16	Reserved	Blank
17	Reserved	Blank
18	Entity Label	Optional, see Note 7
19	Entity Subscript No.	Optional, see Note 8
20	Sequence Number	DE line number, see Note 4

Parameter Data

<u>Index</u>	<u>Description</u>
1	External reference entity symbolic name
2	Number of associativity instance points (= 0 or blank)
3	Number of property pointers (= 0 or blank)

4.2.16.3 Bolt Attributes (Entity 422, Form 0)

Directory Entry

<u>Field#</u>	<u>Field Name</u>	<u>Description</u>
1	Entity Type Number	422
2	Parameter Data	Pointer to corresponding PD record, see Note 1
3	Structure	Negative pointer to attribute definition, see Note 6
4	Line Font Pattern	0 or blank
5	Level	0 or blank
6	View	0 or blank
7	Transformation Matrix	0 or blank
8	Label Pointer	0 or blank
9A	Blank Status	00
9B	Subordinate Switch	00
9C	Entity Use	03
9D	Hierarchy	00
10	Sequence Number	DE line number, see Note 2
11	Entity Type Number	422
12	Line Weight	0 or blank
13	Color Number	0 or blank
14	Parameter Line Count	Number of lines in PD record, see Note 3
15	Form Number	0
16	Reserved	Blank
17	Reserved	Blank
18	Entity Label	Optional, see Note 7
19	Entity Subscript No.	Optional, see Note 8
20	Sequence Number	DE line number, see Note 4

Parameter Data

<u>Index</u>	<u>Description</u>
1	Piping object type (AT = 17, ALT = 4)
2	Fastener type value (AT = 35, ALT = 4)
3	Stock number value (AT = 5, ALT = 4)
4	Material description value (AT = 50, ALT = 4)
5	Bolt type value (AT = 116, ALT = 4)
6	Bolt length value (AT = 117, ALT = 4)
7	Bolt length units value (AT = 118, ALT = 4)
8	Bolt diameter value (AT = 119, ALT = 4)
9	Bolt diameter units value (AT = 120, ALT = 4)
10	Quantity value (AT = 137, ALT = 4)
11	Quantity units value (AT = 138, ALT = 4)
.	.
.	.
.	.
N	Last attribute value
N+1	Number of associativity instance pointers (= 0 or blank)
N+2	Number of property pointers (= 0 or blank)

4.2.16.4 Bolt Attributes Definition (Entity 322, Form 0)

Directory Entry

<u>Field#</u>	<u>Field Name</u>	<u>Description</u>
1	Entity Type Number	322
2	Parameter Data	Pointer to corresponding PD record, see Note 1
3	Structure	0 or blank
4	Line Font Pattern	0 or blank
5	Level	0 or blank
6	View	0 or blank
7	Transformation Matrix	0 or blank
8	Label Pointer	0 or blank
9A	Blank Status	00
9B	Subordinate Switch	00
9C	Entity Use	02
9D	Hierarchy	00
10	Sequence Number	DE line number, see Note 2
11	Entity Type Number	322
12	Line Weight	0 or blank
13	Color Number	0 or blank
14	Parameter Line Count	Number of lines in PD record, see Note 3
15	Form Number	0
16	Reserved	Blank
17	Reserved	Blank
18	Entity Label	Optional, see Note 7
19	Entity Subscript No.	Optional, see Note 8
20	Sequence Number	DE line number, see Note 4

Parameter Data

<u>Index</u>	<u>Description</u>
1	Attribute table name (= 4HBOLT)
2	Attribute list type (= 4)
3	Number of attributes in table (= N)
4	First attribute type (= 17)
5	First attribute value data type (= 3)
6	First attribute value count (= 1)
7	Second attribute type (= 35)
8	Second attribute value data type (= 3)
9	Second attribute value count (= 1)
10	Third attribute type (= 5)
11	Third attribute value data type (= 3)
12	Third attribute value count (= 1)
13	Fourth attribute type (= 50)
14	Fourth attribute value data type (= 3)
15	Fourth attribute value count (= 1)
16	Fifth attribute type (= 116)
17	Fifth attribute value data type (= 3)
18	Fifth attribute value count (= 1)
19	Sixth attribute type (= 117)
20	Sixth attribute value data type (= 2)
21	Sixth attribute value count (= 1)

22	Seventh attribute type (= 118)
23	Seventh attribute value data type (= 3)
24	Seventh attribute value count (= 1)
25	Eighth attribute type (= 119)
26	Eighth attribute value data type (= 2)
27	Eighth attribute value count (= 1)
28	Ninth attribute type (= 1120)
29	Ninth attribute value data type (= 3)
30	Ninth attribute value count (= 1)
31	Tenth attribute type (= 137)
32	Tenth attribute value data type (= 2)
33	Tenth attribute value count (= 1)
34	Eleventh attribute type (= 138)
35	Eleventh attribute value data type (= 3)
36	Eleventh attribute value count (= 1)
.	.
.	.
.	.
N*3+1	Last attribute type
N*3+2	Last attribute value data type
N*3+3	Last attribute value count (AVC(N) = 1)
N*3+4	Number of associativity instance pointers (= 0 or blank)
N*3+5	Number of property pointers (= 0 or blank)

4.2.16.5 Gasket Attributes (Entity 422, Form 0)

Directory Entry

<u>Field#</u>	<u>Field Name</u>	<u>Description</u>
1	Entity Type Number	422
2	Parameter Data	Pointer to corresponding PD record, see Note 1
3	Structure	Negative pointer to attribute definition, see Note 6
4	Line Font Pattern	0 or blank
5	Level	0 or blank
6	View	0 or blank
7	Transformation Matrix	0 or blank
8	Label Pointer	0 or blank
9A	Blank Status	00
9B	Subordinate Switch	00
9C	Entity Use	03
9D	Hierarchy	0010
10	Sequence Number	DE line number, see Note 2
11	Entity Type Number	422
12	Line Weight	0 or blank
13	Color Number	0 or blank
14	Parameter Line Count	Number of lines in PD record, see Note 3
15	Form Number	0
16	Reserved	Blank
17	Reserved	Blank
18	Entity Label	Optional, see Note 7
19	Entity Subscript No.	Optional, see Note 8
20	Sequence Number	DE line number, see Note 4

Parameter Data

<u>Index</u>	<u>Description</u>
1	Piping object type value (AT = 17, ALT = 4)
2	Fastener type value (AT = 35, ALT = 4)
3	Stock number value (AT = 5, ALT = 4)
4	Material description value (AT = 50, ALT = 4)
5	Gasket thickness value (AT = 51, ALT = 4)
6	Gasket thickness units value (AT = 52, ALT = 4)
.	.
.	.
.	.
N	Last attribute value
N+1	Number of associativity instance pointers (= 0 or blank)
N+2	Number of property pointers (= 0 or blank)

4.2.16.6 Gasket Attributes Definition (Entity 322, Form 0)

Directory Entry

<u>Field#</u>	<u>Field Name</u>	<u>Description</u>
1	Entity Type Number	322
2	Parameter Data	Pointer to corresponding PD record, see Note 1
3	Structure	0 or blank
4	Line Font Pattern	0 or blank
5	Level	0 or blank
6	View	0 or blank
7	Transformation Matrix	0 or blank
8	Label Pointer	0 or blank
9A	Blank Status	00
9B	Subordinate Switch	00
9C	Entity Use	02
9D	Hierarchy	00
10	Sequence Number	DE line number, see Note 2
11	Entity Type Number	322
12	Line Weight	0 or blank
13	Color Number	0 or blank
14	Parameter Line Count	Number of lines in PD record, see Note 3
15	Form Number	0
16	Reserved	Blank
17	Reserved	Blank
18	Entity Label	Optional, see Note 7
19	Entity Subscript No.	Optional, see Note 8
20	Sequence Number	DE line number, see Note 4

Parameter Data

<u>Index</u>	<u>Description</u>
1	Attribute table name (= 6HGASKET)
2	Attribute list type (= 4)
3	Number of attributes in table (= N)
4	First attribute type (= 17)
5	First attribute value data type (= 3)
6	First attribute value count (= 1)
7	Second attribute type (= 35)
8	Second attribute value data type (= 3)
9	Second attribute value count (= 1)
10	Third attribute type (= 5)
11	Third attribute value data type (= 3)
12	Third attribute value count (= 1)
13	Fourth attribute type (= 50)
14	Fourth attribute value data type (= 3)
15	Fourth attribute value count (= 1)
16	Fifth attribute type (= 51)
17	Fifth attribute value data type (= 2)
18	Fifth attribute value count (= 1)
19	Sixth attribute type (= 52)
20	Sixth attribute value data type (= 3)
21	Sixth attribute value count (= 1)

.	.
.	.
.	.
N*3+1	Last attribute type
N*3+2	Last attribute value data type
N*3+3	Last attribute value count (AVC(N) = 1)
N*3+4	Number of associativity instance pointers (= 0 or blank)
N*3+5	Number of property pointers (= 0 or blank)

4.2.16.7 Other Fastener Attributes (Entity 422, Form 0)

Directory Entry

<u>Field#</u>	<u>Field Name</u>	<u>Description</u>
1	Entity Type Number	422
2	Parameter Data	Pointer to corresponding PD record, see Note 1
3	Structure	Negative pointer to attribute definition, see Note 6
4	Line Font Pattern	0 or blank
5	Level	0 or blank
6	View	0 or blank
7	Transformation Matrix	0 or blank
8	Label Pointer	0 or Blank
9A	Blank Status	00
9B	Subordinate Switch	00
9C	Entity Use	03
9D	Hierarchy	00
10	Sequence Number	DE line number, see Note 2
11	Entity Type Number	422
12	Line Weight	0 or blank
13	Color Number	0 or blank
14	Parameter Line Count	Number of lines in PD record, see Note 3
15	Form Number	0
16	Reserved	Blank
17	Reserved	Blank
18	Entity Label	Optional, see Note 7
19	Entity Subscript No.	Optional, see Note 8
20	Sequence Number	DE line number, see Note 4

Parameter Data

<u>Index</u>	<u>Description</u>
1	Piping object type value (AT = 17, ALT = 4)
2	Fastener type value (AT = 35, ALT = 4)
3	Stock number value (AT = 5, ALT = 4)
4	Material description value (AT = 50, ALT = 4)
5	Quantity value (AT = 137, ALT = 4)
6	Quantity units value (AT = 138, ALT = 4)
.	.
.	.
.	.
N	Last attribute value
N+1	Number of associativity instance pointers (= 0 or blank)
N+2	Number of property pointers (= 0 or blank)

4.2.16.8 Other Fastener Attributes Definition (Entity 322, Form 0)

Directory Entry

<u>Field#</u>	<u>Field Name</u>	<u>Description</u>
1	Entity Type Number	322
2	Parameter Data	Pointer to corresponding PD record, see Note 1
3	Structure	0 or blank
4	Line Font Pattern	0 or blank
5	Level	0 or blank
6	View	0 or blank
7	Transformation Matrix	0 or blank
8	Label Pointer	0 or blank
9A	Blank Status	00
9B	Subordinate Switch	00
9C	Entity Use	02
9D	Hierarchy	00
10	Sequence Number	DE line number, see Note 2
11	Entity Type Number	322
12	Line Weight	0 or blank
13	Color Number	0 or blank
14	Parameter Line Count	Number of lines in PD record, see Note 3
15	Form Number	0
16	Reserved	Blank
17	Reserved	Blank
18	Entity Label	Optional, see Note 7
19	Entity Subscript No.	Optional, see Note 8
20	Sequence Number	DE line number, see Note 4

Parameter Data

<u>Index</u>	<u>Description</u>
1	Attribute table name (= 14HOTHER FASTENER)
2	Attribute list type (= 4)
3	Number of attributes in table (= N)
4	First attribute type (= 17)
5	First attribute value data type (= 3)
6	First attribute value count (= 1)
7	Second attribute type (= 35)
8	Second attribute value data type (= 3)
9	Second attribute value count (= 1)
10	Third attribute type (= 5)
11	Third attribute value data type (= 3)
12	Third attribute value count (= 1)
13	Fourth attribute type (= 50)
14	Fourth attribute value data type (= 3)
15	Fourth attribute value count (= 1)
16	Fifth attribute type (= 137)
17	Fifth attribute value data type (= 2)
18	Fifth attribute value count (= 1)
19	Sixth attribute type (= 138)
20	Sixth attribute value data type (= 3)
21	Sixth attribute value count (= 1)

.	.
.	.
.	.
N*3+1	Last attribute type
N*3+2	Last attribute value data type
N*3+3	Last attribute value count (AVC(N) = 1)
N*3+4	Number of associativity instance pointers (= 0 or blank)
N*3+5	Number of property pointers (= 0 or blank)

4.2.16.9 Piping Joint Attributes (Entity 422, Form 0)

Directory Entry

<u>Field#</u>	<u>Field Name</u>	<u>Description</u>
1	Entity Type Number	422
2	Parameter Data	Pointer to corresponding PD record, see Note 1
3	Structure	Negative pointer to attribute definition, see Note 6
4	Line Font Pattern	0 or blank
5	Level	0 or blank
6	View	0 or blank
7	Transformation Matrix	0 or blank
8	Label Pointer	0 or blank
9A	Blank Status	00
9B	Subordinate Switch	00
9C	Entity Use	03
9D	Hierarchy	00
10	Sequence Number	DE line number, see Note 2
11	Entity Type Number	422
12	Line Weight	0 or blank
13	Color Number	0 or blank
14	Parameter Line Count	Number of lines in PD record, see Note 3
15	Form Number	0
16	Reserved	Blank
17	Reserved	Blank
18	Entity Label	Optional, see Note 7
19	Entity Subscript No.	Optional, see Note 8
20	Sequence Number	DE line number, see Note 4

Parameter Data

<u>Index</u>	<u>Description</u>
1	Piping object typevalue (AT = 17, ALT = 4)
2	Joint identification number value (AT = 6, ALT = 4)
3	Joint fabrication location (AT = 104, ALT = 4)
.	.
.	.
.	.
N	Last attribute value
N+1	Number of associativity instance pointers (= 0 or blank)
N+2	Number of property pointers (= 0 or blank)

4.2.16.10 Piping Joint Attributes Definition (Entity 322, Form 0)

Directory Entry

<u>Field#</u>	<u>Field Name</u>	<u>Description</u>
1	Entity Type Number	322
2	Parameter Data	Pointer to corresponding PD record, see Note 1
3	Structure	0 or blank
4	Line Font Pattern	0 or blank
5	Level	0 or blank
6	View	0 or blank
7	Transformation Matrix	0 or blank
8	Label Pointer	0 or blank
9A	Blank Status	00
9B	SubordinateSwitch	00
9C	Entity Use	02
9D	Hierarchy	00
10	Sequence Number	DE line number, see Note 2
11	Entity Type Number	322
12	Line Weight	0 or blank
13	Color Number	0 or blank
14	Parameter Line Count	Number of lines in PD record, see Note 3
15	Form Number	0
16	Reserved	Blank
17	Reserved	Blank
18	Entity Label	Optional, see Note 7
19	Entity Subscript No.	Optional, see Note 8
20	Sequence Number	DE line number, see Note 4

Parameter Data

<u>Index</u>	<u>Description</u>
1	Attribute table name (= 12HPIPING JOINT)
2	Attribute list type (= 4)
3	Number of attributes in table (= N)
4	First attribute type (= 17)
5	First attribute value data type (= 3)
6	First attribute value count (= 1)
7	Second attribute type (= 6)
8	Second attribute value data type (= 3)
9	Second attribute value count (= 1)
10	Third attribute type (= 104)
11	Third attribute value data type (= 3)
12	Third attribute value count (= 1)
.	.
.	.
.	.
N*3+1	Last attribute type
N*3+2	Last attribute value data type
N*3+3	Last attribute value count (AVC(N) = 1)
N*3+4	Number of associativity instance pointers (= 0 or blank)
N*3+5	Number of property pointers (= 0 or blank)

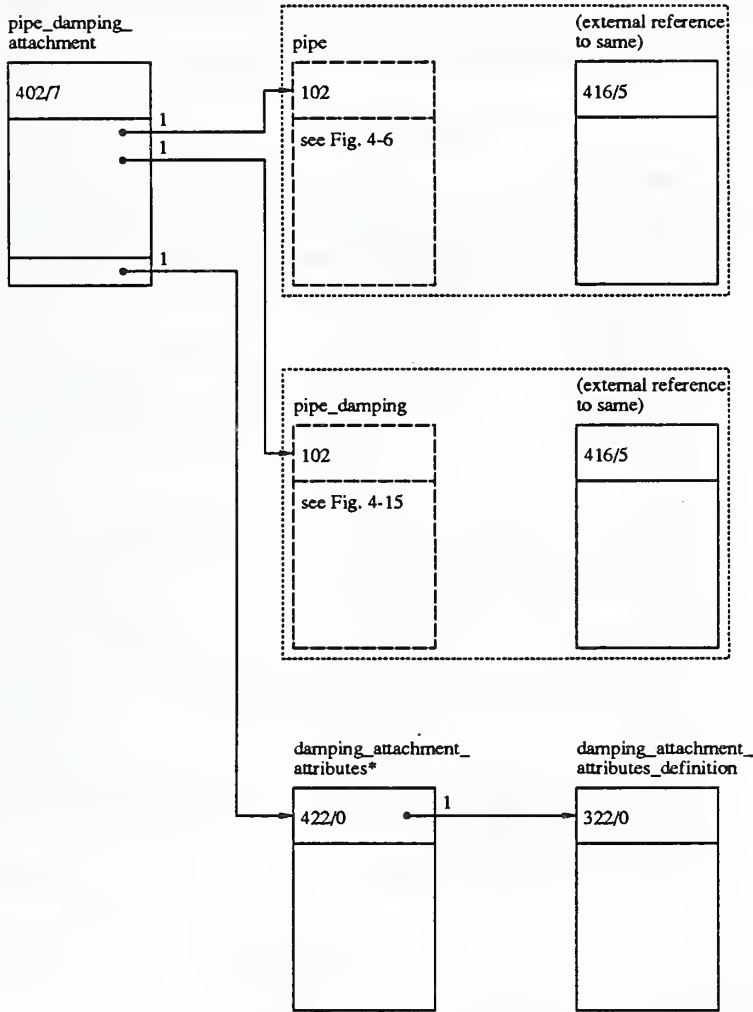

*Note:
damping_attachment_attributes are:
piping_object_type

4.2.17 Pipe Damping Attachment

4.2.17.1 Pipe Damping Attachment Group Associativity (Entity 402, Form 7)

Directory Entry

<u>Field#</u>	<u>Field Name</u>	<u>Description</u>
1	Entity Type Number	402
2	Parameter Data	Pointer to corresponding PD record, see Note 1
3	Structure	0 or blank
4	Line Font Pattern	0 or blank
5	Level	0 or blank
6	View	0 or blank
7	Transformation Matrix	0 or blank
8	Label Pointer	0 or blank
9A	Blank Status	00
9B	Subordinate Switch	00
9C	Entity Use	03
9D	Hierarchy	00
10	Sequence Number	DE line number, see Note 2
11	Entity Type Number	402
12	Line Weight	0 or blank
13	Color Number	0 or blank
14	Parameter Line Count	Number of lines in PD record, see Note 3
15	Form Number	7
16	Reserved	Blank
17	Reserved	Blank
18	Entity Label	Optional, see Note 7
19	Entity Subscript No.	Optional, see Note 8
20	Sequence Number	DE line number, see Note 4

Parameter Data

<u>Index</u>	<u>Description</u>
1	Number of entity pointers (= 2)
2	Pointer to pipe (Entity 102) or pipe external reference (Entity 416/5)
3	Pointer to pipe damping (Entity 102) or pipe damping external reference (Entity 416/5)
4	Number of associativity instance pointers (= 0 or blank)
5	Number of property pointers (= 1)
6	Pointer to pipe damping attachment attribute table instance (Entity 422/0)

4.2.17.2 Pipe External Reference (Entity 416, Form 5)

Directory Entry

<u>Field #</u>	<u>Field Name</u>	<u>Description</u>
1	Entity Type Number	416
2	Parameter Data	Pointer to corresponding PD record, see Note 1
3	Structure	0 or blank
4	Line Font Pattern	0 or blank
5	Level	0 or blank
6	View	0 or blank
7	Transformation Matrix	0 or blank
8	Label Pointer	0 or blank
9A	Blank Status	00
9B	Subordinate Switch	00
9C	Entity Use	04
9D	Hierarchy	00
10	Sequence Number	DE line number, see Note 2
11	Entity Type Number	416
12	Line Weight	0 or blank
13	Color Number	0 or blank
14	Parameter Line Count	Number of lines in PD record, see Note 3
15	Form Number	5
16	Reserved	Blank
17	Reserved	Blank
18	Entity Label	Optional, see Note 7
19	Entity Subscript No.	Optional, see Note 8
20	Sequence Number	DE line number, see Note 4

Parameter Data

<u>Index</u>	<u>Description</u>
1	External reference entity symbolic name - for pipe = pipe identifier
2	Number of associativity instance points (= 0 or blank)
3	Number of property pointers (= 0 or blank)

4.2.17.3 Pipe Damping External Reference (Entity 416, Form 5)

Directory Entry

<u>Field #</u>	<u>Field Name</u>	<u>Description</u>
1	Entity Type Number	416
2	Parameter Data	Pointer to corresponding PD record, see Note 1
3	Structure	0 or blank
4	Line Font Pattern	0 or blank
5	Level	0 or blank
6	View	0 or blank
7	Transformation Matrix	0 or blank
8	Label Pointer	0 or blank
9A	Blank Status	00
9B	Subordinate Switch	00
9C	Entity Use	04
9D	Hierarchy	00
10	Sequence Number	DE line number, see Note 2
11	Entity Type Number	416
12	Line Weight	0 or blank
13	Color Number	0 or blank
14	Parameter Line Count	Number of lines in PD record, see Note 3
15	Form Number	5
16	Reserved	Blank
17	Reserved	Blank
18	Entity Label	Optional, see Note 7
19	Entity Subscript No.	Optional, see Note 8
20	Sequence Number	DE line number, see Note 4

Parameter Data

<u>Index</u>	<u>Description</u>
1	External reference entity symbolic name - for pipe damping = pipe damping identifier
2	Number of associativity instance points (= 0 or blank)
3	Number of property pointers (= 0 or blank)

4.2.17.4 Pipe Damping Attachment Attributes (Entity 422, Form 0)

Directory Entry

<u>Field#</u>	<u>Field Name</u>	<u>Description</u>
1	Entity Type Number	422
2	Parameter Data	Pointer to corresponding PD record, see Note 1
3	Structure	Negative pointer to attribute definition, see Note 6
4	Line Font Pattern	0 or blank
5	Level	0 or blank
6	View	0 or blank
7	Transformation Matrix	0 or blank
8	Label Pointer	0 or blank
9A	Blank Status	00
9B	Subordinate Switch	00
9C	Entity Use	03
9D	Hierarchy	00
10	Sequence Number	DE line number, see Note 2
11	Entity Type Number	422
12	Line Weight	0 or blank
13	Color Number	0 or blank
14	Parameter Line Count	Number of lines in PD record, see Note 3
15	Form Number	0
16	Reserved	Blank
17	Reserved	Blank
18	Entity Label	Optional, see Note 7
19	Entity Subscript No.	Optional, see Note 8
20	Sequence Number	DE line number, see Note 4

Parameter Data

<u>Index</u>	<u>Description</u>
1	Piping object type value (AT = 17, ALT = 4)
.	.
.	.
.	.
N	Last attribute value
N+1	Number of associativity instance pointers (= 0 or blank)
N+2	Number of property pointers (= 0 or blank)

4.2.17.5 Pipe Damping Attachment Attributes Definition (Entity 322, Form 0)

Directory Entry

<u>Field#</u>	<u>Field Name</u>	<u>Description</u>
1	Entity Type Number	322
2	Parameter Data	Pointer to corresponding PD record, see Note 1
3	Structure	0 or blank
4	Line Font Pattern	0 or blank
5	Level	0 or blank
6	View	0 or blank
7	Transformation Matrix	0 or blank
8	Label Pointer	0 or blank
9A	Blank Status	00
9B	Subordinate Switch	00
9C	Entity Use	02
9D	Hierarchy	00
10	Sequence Numbe	DE line number, see Note 2
11	Entity Type Number	322
12	Line Weight	0 or blank
13	Color Number	0 or blank
14	Parameter Line Count	Number of lines in PD record, see Note 3
15	Form Number	0
16	Reserved	Blank
17	Reserved	Blank
18	Entity Label	Optional, see Note 7
19	Entity Subscript No.	Optional, see Note 8
20	Sequence Number	DE line number, see Note 4

Parameter Data

<u>Index</u>	<u>Description</u>
1	Attribute table name (= 23HPIPE DAMPING ATTACHMENT)
2	Attribute list type (= 4)
3	Number of attributes in table (= N)
4	First attribute type (= 17)
5	First attribute value data type (= 3)
6	First attribute value count (= 1)
.	.
.	.
.	.
N*3+1	Last attribute type
N*3+2	Last attribute value data type
N*3+3	Last attribute value count (AVC(N) = 1)
N*3+4	Number of associativity instance pointers (= 0 or blank)
N*3+5	Number of property pointers (= 0 or blank)

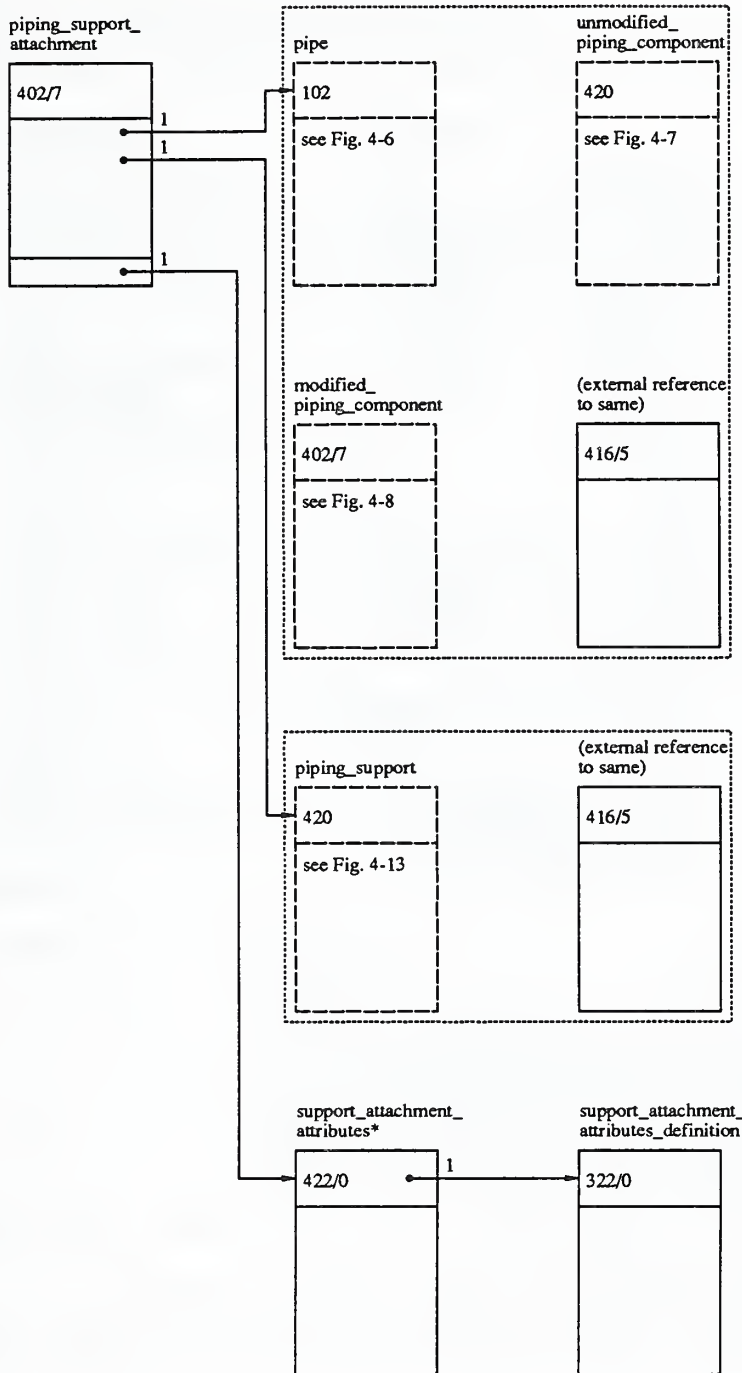

*Note:
support_attachment_attributes are:
piping_object_type

4.2.18 Piping Support Attachment

4.2.18.1 Piping Support Attachment Group Associativity (Entity 402, Form 7)

Directory Entry

<u>Field#</u>	<u>Field Name</u>	<u>Description</u>
1	Entity Type Number	402
2	Parameter Data	Pointer to corresponding PD record, see Note 1
3	Structure	0 or blank
4	Line Font Pattern	0 or blank
5	Level	0 or blank
6	View	0 or blank
7	Transformation Matrix	0 or blank
8	Label Pointer	0 or blank
9A	Blank Status	00
9B	Subordinate Switch	00
9C	Entity Use	03
9D	Hierarchy	00
10	Sequence Number	DE line number, see Note 2
11	Entity Type Number	402
12	Line Weight	0 or blank
13	Color Number	0 or blank
14	Parameter Line Count	Number of lines in PD record, see Note 3
15	Form Number	7
16	Reserved	Blank
17	Reserved	Blank
18	Entity Label	Optional, see Note 7
19	Entity Subscript No.	Optional, see Note 8
20	Sequence Number	DE line number, see Note 4

Parameter Data

<u>Index</u>	<u>Description</u>
1	Number of entity pointers (= 2)
2	Pointer to one of the following: - pipe (Entity 102) - unmodified piping component (Entity 420) - modified piping component (Entity 402/7) - external reference (Entity 416/5)
3	Pointer to piping support (Entity 420) or piping support external reference (Entity 416/5)
4	Number of associativity instance pointers (= 0 or blank)
5	Number of property pointers (= 1)
6	Pointer to piping support attachments attribute table instance (Entity 422/0)

4.2.18.2 External Reference (Entity 416, Form 5)

Directory Entry

<u>Field #</u>	<u>Field Name</u>	<u>Description</u>
1	Entity Type Number	416
2	Parameter Data	Pointer to corresponding PD record, see Note 1
3	Structure	0 or blank
4	Line Font Pattern	0 or blank
5	Level	0 or blank
6	View	0 or blank
7	Transformation Matrix	0 or blank
8	Label Pointer	0 or blank
9A	Blank Status	00
9B	Subordinate Switch	00
9C	Entity Use	04
9D	Hierarchy	00
10	Sequence Number	DE line number, see Note 2
11	Entity Type Number	416
12	Line Weight	0 or blank
13	Color Number	0 or blank
14	Parameter Line Count	Number of lines in PD record, see Note 3
15	Form Number	5
16	Reserved	Blank
17	Reserved	Blank
18	Entity Label	Optional, see Note 7
19	Entity Subscript No.	Optional, see Note 8
20	Sequence Number	DE line number, see Note 4

Parameter Data

<u>Index</u>	<u>Description</u>
1	External reference entity symbolic name - for pipe = pipe identifier - for unmodified piping component = piping component identifier - for modified piping component = piping component identifier
2	Number of associativity instance points (= 0 or blank)
3	Number of property pointers (= 0 or blank)

4.2.18.3 Piping Support External Reference (Entity 416, Form 5)

Directory Entry

<u>Field #</u>	<u>Field Name</u>	<u>Description</u>
1	Entity Type Number	416
2	Parameter Data	Pointer to corresponding PD record, see Note 1
3	Structure	0 or blank
4	Line Font Pattern	0 or blank
5	Level	0 or blank
6	View	0 or blank
7	Transformation Matrix	0 or blank
8	Label Pointer	0 or blank
9A	Blank Status	00
9B	Subordinate Switch	00
9C	Entity Use	04
9D	Hierarchy	00
10	Sequence Number	DE line number, see Note 2
11	Entity Type Number	416
12	Line Weight	0 or blank
13	Color Number	0 or blank
14	Parameter Line Count	Number of lines in PD record, see Note 3
15	Form Number	5
16	Reserved	Blank
17	Reserved	Blank
18	Entity Label	Optional, see Note 7
19	Entity Subscript No.	Optional, see Note 8
20	Sequence Number	DE line number, see Note 4

Parameter Data

<u>Index</u>	<u>Description</u>
1	External reference entity symbolic name - for piping support = piping support identifier
2	Number of associativity instance points (= 0 or blank)
3	Number of property pointers (= 0 or blank)

4.2.18.4 Piping Support Attachment Attributes (Entity 422, Form 0)

Directory Entry

<u>Field#</u>	<u>Field Name</u>	<u>Description</u>
1	Entity Type Number	422
2	Parameter Data	Pointer to corresponding PD record, see Note 1
3	Structure	Negative pointer to attribute definition, see Note 6
4	Line Font Pattern	0 or blank
5	Level	0 or blank
6	View	0 or blank
7	Transformation Matrix	0 or blank
8	Label Pointer	0 or blank
9A	Blank Status	00
9B	Subordinate Switch	00
9C	Entity Use	03
9D	Hierarchy	00
10	Sequence Number	DE line number, see Note 2
11	Entity Type Number	422
12	Line Weight	0 or blank
13	Color Number	0 or blank
14	Parameter Line Count	Number of lines in PD record, see Note 3
15	Form Number	0
16	Reserved	Blank
17	Reserved	Blank
18	Entity Label	Optional, see Note 7
19	Entity Subscript No.	Optional, see Note 8
20	Sequence Number	DE line number, see Note 4

Parameter Data

<u>Index</u>	<u>Description</u>
1	Piping object type value (AT = 17, ALT = 4)
.	.
.	.
.	.
N	Last attribute value
N+1	Number of associativity instance pointers (= 0 or blank)
N+2	Number of property pointers (= 0 or blank)

4.2.18.5 Piping Support Attachment Attributes Definition (Entity 322, Form 0)

Directory Entry

<u>Field#</u>	<u>Field Name</u>	<u>Description</u>
1	Entity Type Number	322
2	Parameter Data	Pointer to corresponding PD record, see Note 1
3	Structure	0 or blank
4	Line Font Pattern	0 or blank
5	Level	0 or blank
6	View	0 or blank
7	Transformation Matrix	0 or blank
8	Label Pointer	0 or blank
9A	Blank Status	00
9B	Subordinate Switch	00
9C	Entity Use	02
9D	Hierarchy	00
10	Sequence Number	DE line number, see Note 2
11	Entity Type Number	322
12	Line Weight	0 or blank
13	Color Number	0 or blank
14	Parameter Line Count	Number of lines in PD record, see Note 3
15	Form Number	0
16	Reserved	Blank
17	Reserved	Blank
18	Entity Label	Optional, see Note 7
19	Entity Subscript No.	Optional, see Note 8
20	Sequence Number	DE line number, see Note 4

Parameter Data

<u>Index</u>	<u>Description</u>
1	Attribute table name (= 25HPIPING SUPPORT ATTACHMENT)
2	Attribute list type (= 4)
3	Number of attributes in table (= N)
4	First attribute type (= 17)
5	First attribute value data type (= 3)
6	First attribute value count (= 1)
.	.
.	.
.	.
N*3+1	Last attribute type
N*3+2	Last attribute value data type
N*3+3	Last attribute value count (AVC(N) = 1)
N*3+4	Number of associativity instance pointers (= 0 or blank)
N*3+5	Number of property pointers (= 0 or blank)

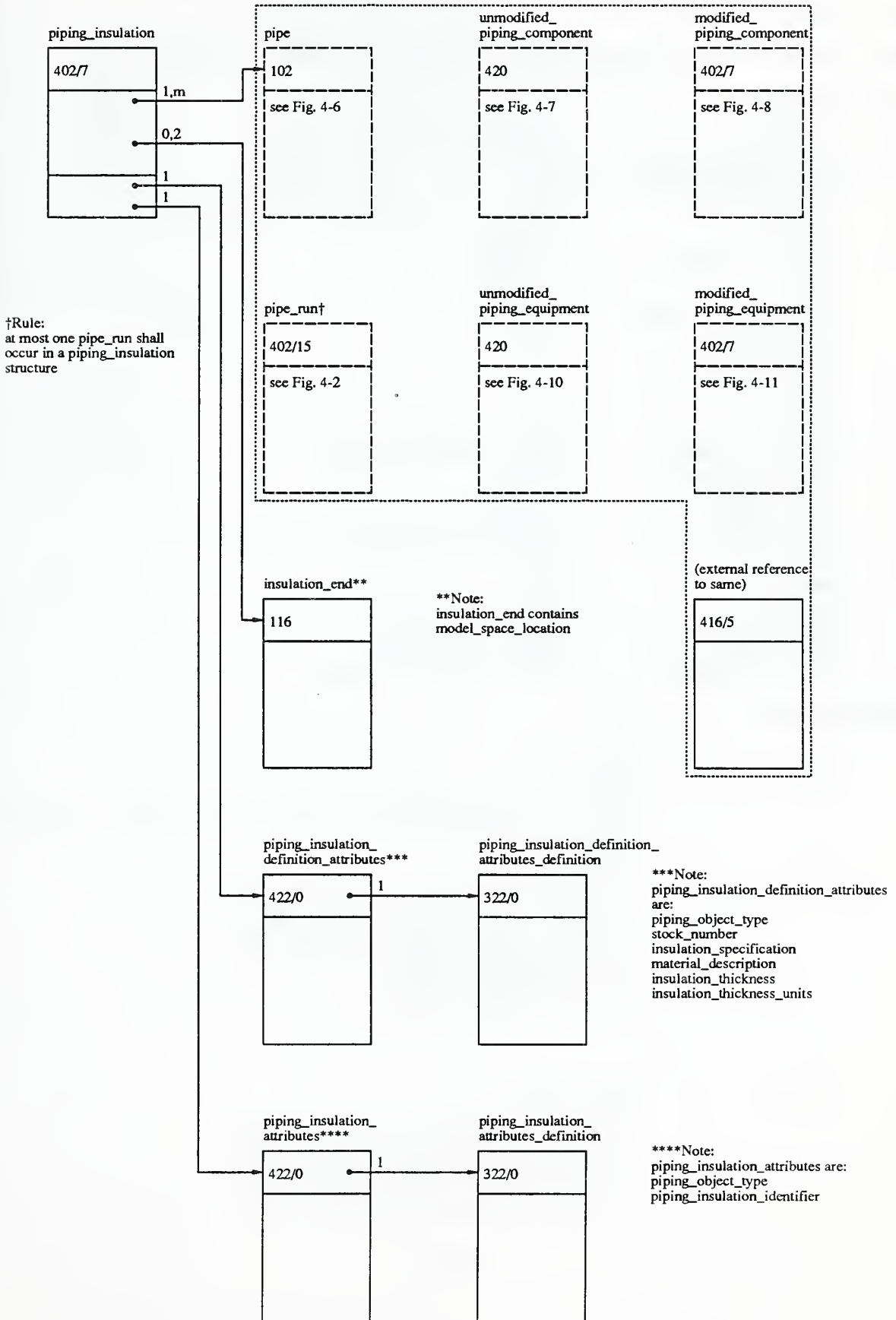

4.2.19 Piping Insulation

4.2.19.1 Piping Insulation Group Associativity (Entity 402, Form 7)

Directory Entry

<u>Field#</u>	<u>Field Name</u>	<u>Description</u>
1	Entity Type Number	402
2	Parameter Data	Pointer to corresponding PD record, see Note 1
3	Structure	0 or blank
4	Line Font Pattern	0 or blank
5	Level	0 or blank
6	View	0 or blank
7	Transformation Matrix	0 or blank
8	Label Pointer	0 or blank
9A	Blank Status	00
9B	Subordinate Switch	00
9C	Entity Use	03
9D	Hierarchy	00
10	Sequence Number	DE line number, see Note 2
11	Entity Type Number	402
12	Line Weight	0 or blank
13	Color Number	0 or blank
14	Parameter Line Count	Number of lines in PD record, see Note 3
15	Form Number	7
16	Reserved	Blank
17	Reserved	Blank
18	Entity Label	Optional, see Note 7
19	Entity Subscript No.	Optional, see Note 8
20	Sequence Number	DE line number, see Note 4

Parameter Data

<u>Index</u>	<u>Description</u>
1	Number of entity pointers (= number of parts (NP) + number of insulation ends (NE= 0 or 2))
2	Pointer to first: - pipe (Entity 102), - unmodified piping component (Entity 420) - modified piping component (Entity 402/7) - unmodified piping equipment (Entity 420) - modified piping equipment (Entity 402/7) - pipe run (Entity 402/15) - external reference (Entity 416/5)
.	.
.	.
.	.
NP+1	Pointer to last: - pipe (Entity 102), - unmodified piping component (Entity 420) - modified piping component (Entity 402/7) - unmodified piping equipment (Entity 420) - modified piping equipment (Entity 402/7)

	- pipe run (Entity 402/15)
	- external reference (Entity 416/5)
NP+2(if NE=2)	Pointer to first insulation end (Entity 116)
NP+3 (if NE=2)	Pointer to second insulation end (Entity 116)
NP+NE+2	Number of associativity instance pointers (= 0 or blank)
NP+NE+3	Number of property pointers (= 2)
NP+NE+4	Pointer to piping insulation attribute table instance (Entity 422/0)
NP+NE+5	Pointer to piping insulation definition attribute table instance (Entity 422/0)

4.2.19.2 External Reference (Entity 416, Form 5)

Directory Entry

<u>Field#</u>	<u>Field Name</u>	<u>Description</u>
1	Entity Type Number	416
2	Parameter Data	Pointer to corresponding PD record, see Note 1
3	Structure	0 or blank
4	Line Font Pattern	0 or blank
5	Level	0 or blank
6	View	0 or blank
7	Transformation Matrix	0 or blank
8	Label Pointer	0 or blank
9A	Blank Status	00
9B	Subordinate Switch	00
9C	Entity Use	04
9D	Hierarchy	00
10	Sequence Number	DE line number, see Note 2
11	Entity Type Number	416
12	Line Weight	0 or blank
13	Color Number	0 or blank
14	Parameter Line Count	Number of lines in PD record, see Note 3
15	Form Number	5
16	Reserved	Blank
17	Reserved	Blank
18	Entity Label	Optional, see Note 7
19	Entity Subscript No.	Optional, see Note 8
20	Sequence Number	DE line number, see Note 4

Parameter Data

<u>Index</u>	<u>Description</u>
1	External reference entity symbolic name - for pipe = pipe identifier - for unmodified piping component = piping component identifier - for modified piping component = piping component identifier - for pipe run = pipe run identifier - for unmodified piping equipment = piping equipment identifier - for modified piping equipment = piping equipment identifier
2	Number of associativity instance pointers (= 0 or blank)
3	Number of property pointers (= 0 or blank)

4.2.19.3 Insulation End Point (Entity 116)

Directory Entry

<u>Field#</u>	<u>Field Name</u>	<u>Description</u>
1	Entity Type Number	116
2	Parameter Data	Pointer to corresponding PD record, see Note 1
3	Structure	0 or blank
4	Line Font Pattern	0 or blank
5	Level	0 or blank
6	View	0 or blank
7	Transformation Matrix	Pointer to transformation matrix, see Note 5
8	Label Pointer	0 or blank
9A	Blank Status	00
9B	Subordinate Switch	02
9C	Entity Use	00
9D	Hierarchy	00
10	Sequence Number	DE line number, see Note 2
11	Entity Type Number	116
12	Line Weight	0 or blank
13	Color Number	0 or blank
14	Parameter Line Count	Number of lines in PD record, see Note 3
15	Form Number	0 or blank
16	Reserved	Blank
17	Reserved	Blank
18	Entity Label	Optional, see Note 7
19	Entity Subscript No.	Optional, see Note 8
20	Sequence Number	DE line number, see Note 4

Parameter Data

<u>Index</u>	<u>Description</u>
1	X coordinate of point in model space
2	Y coordinate of point in model space
3	Z coordinate of point in model space

4.2.19.4 Piping Insulation Definition Attributes (Entity 422, Form 0)

Directory Entry

<u>Field#</u>	<u>Field Name</u>	<u>Description</u>
1	Entity Type Number	422
2	Parameter Data	Pointer to corresponding PD record, see Note 1
3	Structure	Negative pointer to attribute definition, see Note 6
4	Line Font Patter	0 or blank
5	Level	0 or blank
6	View	0 or blank
7	Transformation Matrix	0 or blank
8	Label Pointer	0 or blank
9A	Blank Status	00
9B	Subordinate Switch	00
9C	Entity Use	03
9D	Hierarchy	00
10	Sequence Number	DE line number, see Note 2
11	Entity Type Number	422
12	Line Weight	0 or blank
13	Color Number	0 or blank
14	Parameter Line Count	Number of lines in PD record, see Note 3
15	Form Number	0
16	Reserved	Blank
17	Reserved	Blank
18	Entity Label	Optional, see Note 7
19	Entity Subscript No.	Optional, see Note 8
20	Sequence Number	DE line number, see Note 4

Parameter Data

<u>Index</u>	<u>Description</u>
1	Piping object type value (AT = 17, ALT = 4)
2	Stock number value (AT = 5, ALT = 4)
3	Insulation specification value (AT = 39, ALT = 4)
4	Material description value (AT = 50, ALT = 4)
5	Insulation thickness value (AT = 121, ALT = 4)
6	Insulation thickness units value (AT = 122, ALT = 4)
.	.
.	.
.	.
N	Last attribute value
N+1	Number of associativity instance pointers (= 0 or blank)
N+2	Number of property pointers (= 0 or blank)

4.2.19.5 Piping Insulation Definition Attributes Definition (Entity 322, Form 0)

Directory Entry

<u>Field#</u>	<u>Field Name</u>	<u>Description</u>
1	Entity Type Number	322
2	Parameter Data	Pointer to corresponding PD record, see Note 1
3	Structure	0 or blank
4	Line Font Pattern	0 or blank
5	Level	0 or blank
6	View	0 or blank
7	Transformation Matrix	0 or blank
8	Label Pointer	0 or blank
9A	Blank Status	00
9B	Subordinate Switch	00
9C	Entity Use	02
9D	Hierarchy	00
10	Sequence Number	DE line number, see Note 2
11	Entity Type Number	322
12	Line Weight	0 or blank
13	Color Number	0 or blank
14	Parameter Line Count	Number of lines in PD record, see Note 3
15	Form Number	0
16	Reserved	Blank
17	Reserved	Blank
18	Entity Label	Optional, see Note 7
19	Entity Subscript No.	Optional, see Note 8
20	Sequence Number	DE line number, see Note 4

Parameter Data

<u>Index</u>	<u>Description</u>
1	Attribute table name (= 28HPIPING INSULATION DEFINITION)
2	Attribute list type (= 4)
3	Number of attributes in table (= N)
4	First attribute type (= 17)
5	First attribute value data type (= 3)
6	First attribute value count (= 1)
7	Second attribute type (= 5)
8	Second attribute value data type (= 3)
9	Second attribute value count (= 1)
10	Third attribute type (= 39)
11	Third attribute value data type (= 3)
12	Third attribute value count (= 1)
13	Fourth attribute type (= 50)
14	Fourth attribute value data type (= 3)
15	Fourth attribute value count (= 1)
16	Fifth attribute type (= 121)
17	Fifth attribute value data type (= 2)
18	Fifth attribute value count (= 1)
19	Sixth attribute type (= 122)
20	Sixth attribute value data type (= 3)
21	Sixth attribute value count (= 1)

.	.
.	.
.	.
N*3+1	Last attribute type
N*3+2	Last attribute value data type
N*3+3	Last attribute value count (AVC(N) = 1)
N*3+4	Number of associativity instance pointers (= 0 or blank)
N*3+5	Number of property pointers (= 0 or blank)

4.2.19.6 Piping Insulation Attributes (Entity 422, Form 0)

Directory Entry

<u>Field#</u>	<u>Field Name</u>	<u>Description</u>
1	Entity Type Number	422
2	Parameter Data	Pointer to corresponding PD record, see Note 1
3	Structure	Negative pointer to attribute definition, see Note 6
4	Line Font Pattern	0 or blank
5	Level	0 or blank
6	View	0 or blank
7	Transformation Matrix	0 or blank
8	Label Pointer	0 or blank
9A	Blank Status	00
9B	Subordinate Switch	00
9C	Entity Use	03
9D	Hierarchy	00
10	Sequence Number	DE line number, see Note 2
11	Entity Type Number	422
12	Line Weight	0 or blank
13	Color Number	0 or blank
14	Parameter Line Count	Number of lines in PD record, see Note 3
15	Form Number	0
16	Reserved	Blank
17	Reserved	Blank
18	Entity Label	Optional, see Note 7
19	Entity Subscript No.	Optional, see Note 8
20	Sequence Number	DE line number, see Note 4

Parameter Data

<u>Index</u>	<u>Description</u>
1	Piping object type value (AT = 17, ALT = 4)
2	Piping insulation identifier value (AT = 19, ALT = 4)
.	.
.	.
.	.
N	Last attribute value
N+1	Number of associativity instance pointers (= 0 or blank)
N+2	Number of property pointers (= 0 or blank)

4.2.19.7 Piping Insulation Attributes Definition (Entity 322, Form 0)

Directory Entry

<u>Field#</u>	<u>Field Name</u>	<u>Description</u>
1	Entity Type Number	322
2	Parameter Data	Pointer to corresponding PD record, see Note 1
3	Structure	0 or blank
4	Line Font Pattern	0 or blank
5	Level	0 or blank
6	View	0 or blank
7	Transformation Matrix	0 or blank
8	Label Pointer	0 or blank
9A	Blank Status	00
9B	Subordinate Switch	00
9C	Entity Use	02
9D	Hierarchy	00
10	Sequence Number	DE line number, see Note 2
11	Entity Type Number	322
12	Line Weight	0 or blank
13	Color Number	0 or blank
14	Parameter Line Count	Number of lines in PD record, see Note 3
15	Form Number	0
16	Reserved	Blank
17	Reserved	Blank
18	Entity Label	Optional, see Note 7
19	Entity Subscript No.	Optional, see Note 8
20	Sequence Number	DE line number, see Note 4

Parameter Data

<u>Index</u>	<u>Description</u>
1	Attribute table name (= 17HPIPING INSULATION)
2	Attribute list type (= 4)
3	Number of attributes in table (= N)
4	First attribute type (= 17)
5	First attribute value data type (= 3)
6	First attribute value count (= 1)
7	Second attribute type (= 19)
8	Second attribute value data type (= 3)
9	Second attribute value count (= 1)
.	.
.	.
.	.
N*3+1	Last attribute type
N*3+2	Last attribute value data type
N*3+3	Last attribute value count (AVC(N) = 1)
N*3+4	Number of associativity instance pointers (= 0 or blank)
N*3+5	Number of property pointers (= 0 or blank)

5. IMPLEMENTATION AND CONFORMANCE TESTING GUIDELINES

The successful exchange of information using an IGES AP requires the participating organizations to establish information configuration control and software configuration control procedures for their product data creation and exchange systems. It must be understood that the use of IGES AP's will in many cases require that organizations revise their policies and procedures for the creation, exchange, and archival storage of product data.

The successful use of an IGES application protocol also requires that the participating IGES processors conform to the AP specification. The purpose of conformance testing is to increase the confidence that different implementations of the AP will be able to exchange information successfully.

This AP requires that the functionality of the piping constructs of the ARM be preserved in the translation into and out of the IGES format. Therefore, the CAD system for which the processors are being tested must provide this minimum level of functionality for modeling 3D piping systems. Processors must completely support the functionality defined in the previous sections to claim conformance to this AP. An AP compliant preprocessor must convert each piping construct of the ARM into the specified IGES constructs of the AIM, with the required attributes and values. An AP compliant postprocessor must convert each IGES construct of the AIM into native constructs which match the geometry, attributes, and relationships of the piping constructs specified in the ARM. The functionality of the piping constructs shall be preserved.

Due to the complexity of this AP, it is not feasible to conduct exhaustive testing of processors for all possible combinations of AP constructs. The conformance testing requirements described in this section cover all constructs of the ARM and all IGES constructs specified in the AIM. The enumerated test purposes (Section 5.3) do not cover all possible combinations of ARM and AIM constructs.

5.1 Processor Conformance Requirements

The conformance requirements for implementations of this AP are enumerated as follows:

Preprocessor:

1. All IGES files created by an AP compliant preprocessor shall conform to the IGES specification, Version 5.0.
2. All IGES files created by an AP compliant preprocessor shall conform to the IGES constructs specified in the AP.
3. An AP compliant preprocessor shall convert each piping construct of the ARM into the IGES constructs specified in the AIM. The functionality defined for each construct of the ARM shall be preserved.

Postprocessor:

1. An AP compliant postprocessor shall read any files that conform to the IGES specification, Version 5.0.
2. An AP compliant postprocessor shall read and interpret files that conform to the IGES constructs specified in the AP.
3. An AP compliant postprocessor shall convert each construct of the AIM into native constructs

which match the geometry, attributes, and relationships of the piping constructs specified in the ARM. The functionality of the piping constructs shall be preserved.

5.2 Development and Use of the IGES Application Protocol Abstract Test Suite

The IGES Application Protocol Abstract Test Suite is divided into nineteen test groups (TG):

- TG-1: Pipe
- TG-2: Object Envelope Definition
- TG-3: Installed Access Envelope
- TG-4: Piping Component Definition
- TG-5: Unmodified Piping Component
- TG-6: Modified Piping Component
- TG-7: Piping Equipment Definition
- TG-8: Unmodified Piping Equipment
- TG-9: Modified Piping Equipment
- TG-10: Piping Support Definition
- TG-11: Piping Support
- TG-12: Pipe Damping
- TG-13: Piping Joint
- TG-14: Pipe Damping Attachment
- TG-15: Piping Support Attachment
- TG-16: Pipe Run
- TG-17: Piping Insulation
- TG-18: Piping Assembly
- TG-19: Piping System

Each test group contains discrete test purposes (TP). A test purpose defines the objective of an abstract test case. An abstract test case is required for the preprocessor and postprocessor. An abstract test case is derived from a test purpose and is written in a formal language. When parameter values are provided for the constructs in the abstract test case, it can be used to generate an executable test case.

An abstract test case contains:

- test purpose;
- test case identifier;
- reference to specific parts of the AP;
- definition of constructs required to exercise the test purpose;
- statements indicating the construction sequence; and
- verdict criteria.

Abstract test cases are documented in non-system specific procedures and are used to produce comparable results from the conformance testing of multiple implementations.

An executable test case is derived from an abstract test case and is in a form which allows it to be run on the implementation under test. An executable test case contains some or all of the following:

- test purpose;
- test case identifier;
- reference to specific parts of the AP;
- constructs required to exercise the test purpose together with their associated parameter values;
- a test script defining the construction sequence;
- verdict criteria;
- an IGES file for postprocessor conformance testing; and
- a pictorial representation of the populated constructs.

Test Group 3: Installed Access Envelope

Test Purposes:

1. CSG block as an element of one installed access envelope
2. CSG right angular wedge as an element of one installed access envelope
3. CSG right circular cylinder as an element of one installed access envelope
4. CSG right circular cone frustum as an element of one installed access envelope
5. CSG sphere as an element of one installed access envelope
6. CSG torus as an element of one installed access envelope
7. CSG solid of revolution as an element of one installed access envelope
8. CSG solid of linear extrusion as an element of one installed access envelope
9. Installed access envelope with more than one element

Test Group 4: Piping Component Definition

Test Purposes:

1. Piping component definition (one or many piping component port definitions, zero or one insulation shape envelope definition, and zero or one access envelope definition)
2. Piping component definition with one piping component port definition (zero or one insulation shape envelope definition and zero or one access envelope definition)
3. Piping component definition with more than one piping component port definition (zero or one insulation shape envelope definition and zero or one access envelope definition)
4. Piping component definition with one insulation shape envelope definition (one or many piping component port definitions and zero or one access envelope definition)
5. Piping component definition with one access envelope definition (one or many piping component port definitions and zero or one insulation shape envelope definition)

Test Group 5: Unmodified Piping Component

Test Purposes:

1. Unmodified piping component (one or many piping component ports)
2. Unmodified piping component with one piping component port
3. Unmodified piping component with more than one piping component port
4. Unmodified piping component which references a definition file for the piping component definition (one or many piping component ports)

Test Group 6 : Modified Piping Component

Test Purposes:

1. Modified piping component (zero, one, or many added piping component ports and zero or one installed access envelope)
2. Modified piping component with one added piping component port (zero or one installed access envelope)
3. Modified piping component with more than one added piping component port (zero or one installed access envelope)
4. Modified piping component with one installed access envelope (zero, one, or many added piping component ports)

Test Group 7: Piping Equipment Definition

Test Purposes:

1. Piping equipment definition (one or many piping equipment port definitions, zero or one insulation shape envelope definition, and zero or one access envelope definition)
2. Piping equipment definition with one piping equipment port definition (zero or one insulation shape envelope definition and zero or one access envelope definition)
3. Piping equipment definition with more than one piping equipment port definition (zero or one insulation shape envelope definition and zero or one access envelope definition)
4. Piping equipment definition with one insulation shape envelope definition (one or many piping equipment port definitions and zero or one access envelope definition)
5. Piping equipment definition with one access envelope definition (one or many piping equipment port definitions and zero or one insulation shape envelope definition)

Test Group 8: Unmodified Piping Equipment

Test Purposes:

1. Unmodified piping equipment (one or many piping equipment ports)
2. Unmodified piping equipment with one piping equipment port
3. Unmodified piping equipment with more than one piping equipment port
4. Unmodified piping equipment which references a definition file for the piping equipment definition (one or many piping equipment ports)

Test Group 9: Modified Piping Equipment

Test Purpose:

1. Modified piping equipment

Test Group 10: Piping Support Definition

Test Purposes:

1. Piping support definition (one or many piping support attachment point definitions)
2. Piping support definition with one piping support attachment point definition
3. Piping support definition with more than one piping support attachment point definition

Test Group 11: Piping Support

Test Purposes:

1. Piping support (one or many piping support attachment points)
2. Piping support with one piping support attachment point
3. Piping support with more than one piping support attachment point
4. Piping support which references a definition file for the piping support definition (one or many piping support attachment points)

Test Group 12: Pipe Damping

Test Purpose:

1. Pipe damping

Test Group 13: Piping Joint

Test Purposes:

1. Piping joint (zero, one, or many bolt sets, gaskets, or other fasteners)
2. Piping joint with one bolt set (zero, one, or many gaskets or other fasteners)
3. Piping joint with more than one bolt set (zero, one, or many gaskets or other fasteners)
4. Piping joint with one gasket (zero, one, or many bolt sets or other fasteners)
5. Piping joint with more than one gasket (zero, one, or many bolt sets or other fasteners)
6. Piping joint with one other fastener (zero, one, or many bolt sets or gaskets)
7. Piping joint with more than one other fastener (zero, one, or many bolt sets or gaskets)
8. Piping joint which references a definition file for one piping port

Test Group 14: Pipe Damping Attachment

Test Purposes:

1. Pipe damping attachment
2. Pipe damping attachment which references a definition file for the attached pipe
3. Pipe damping attachment which references a definition file for the attached pipe damping

Test Group 15: Piping Support Attachment

Test Purposes:

1. Piping support attachment
2. Piping support attachment which attaches to a pipe
3. Piping support attachment which attaches to an unmodified piping component
4. Piping support attachment which attaches to a modified piping component
5. Piping support attachment which references a definition file for the attached pipe run part
6. Piping support attachment which references a definition file for the attached piping support

Test Group 16: Pipe Run

Test Purposes:

1. Pipe run (one or many pipe run parts)
2. Pipe run with one pipe
3. Pipe run with one unmodified piping component
4. Pipe run with one modified piping component
5. Pipe run with more than one pipe run part
6. Pipe run which references a definition file for one pipe run part (one or many pipe run parts)

Test Group 17: Piping Insulation

Test Purposes:

1. Piping insulation (insulating one or many piping parts and with zero or two insulation ends)
2. Piping insulation insulating one pipe (zero or two insulation ends)
3. Piping insulation insulating one unmodified piping component (zero or two insulation ends)
4. Piping insulation insulating one modified piping component (zero or two insulation ends)
5. Piping insulation insulating one pipe run (zero or two insulation ends)
6. Piping insulation insulating one unmodified piping equipment (zero or two insulation ends)
7. Piping insulation insulating one modified piping equipment (zero or two insulation ends)
8. Piping insulation insulating more than one piping part (zero or two insulation ends)
9. Piping insulation with zero insulation ends (insulating one or many piping parts)
10. Piping insulation with two insulation ends (insulating one or many piping parts)
11. Piping insulation which references a definition file for one insulated piping part (insulating one or many piping parts and with zero or two insulation ends)

Test Group 18: Piping Assembly

Test Purposes:

1. Piping assembly (one or many piping parts)
2. Piping assembly with one pipe
3. Piping assembly with one unmodified piping component
4. Piping assembly with one modified piping component
5. Piping assembly with one unmodified piping equipment
6. Piping assembly with one modified piping equipment
7. Piping assembly with one pipe damping
8. Piping assembly with one piping support
9. Piping assembly with one piping assembly
10. Piping assembly with more than one piping assembly member
11. Piping assembly which references a definition file for one piping assembly member (one or many piping assembly members)

Test Group 19: Piping System

Test Purposes:

1. Piping system (one or many piping system members)
2. Piping system with one pipe run
3. Piping system with one unmodified piping equipment
4. Piping system with one modified piping equipment
5. Piping system with more than one piping system member
6. Piping system which references a definition file for one piping system member (one or many piping system members)

6. REFERENCES

1. *Initial Graphics Exchange Specification (IGES), Version 5.0*, National Institute of Standards and Technology (U.S.) NISTIR 4412; September 1990.
2. Harrison, Randy J. and Palmer, Mark E.; *Guidelines for the Specification and Validation of IGES Application Protocols*, National Institute of Standards and Technology (U.S.) NISTIR 88-3846; January 1989.
3. *Software Engineering Standards: ANSI/IEEE Std 729-1983, Glossary of Software Engineering Terminology*, The Institute of Electrical and Electronics Engineers, Inc., 1984.
4. Martin, Douglas J. and Lovdahl, Rick; *Reference Model for Distribution Systems*, Navy-Industry Digital Data Exchange Standards Committee (NIDDESC), Working Document Version 1.1, December 1989.

APPENDIX A. ACTIVITY MODEL FOR 3D PIPING SYSTEMS DESIGN

Activity Model for Piping Systems Design¹ Version 1.1

Julian Fowler
Research & Development Officer
CAD-CAM Data Exchange Technical Centre

1. Introduction

This document gives an overview of the activities required in the design of piping systems used in process plants and in ships. The application activity model was used and modified while developing the scope and requirements of the 3D Piping IGES Application Protocol.

This model is based upon and makes extensive use of a much larger model developed by Pat Harrow within the ISO STEP project.² This model is restricted to the activities required for piping system design within the context of a complete plant or ship design. Systems such as structural steelwork, electrical, ducting, etc. are excluded.

2. Piping System Design Overview, model A0

This model shows the top level activities of the process, starting with the required system throughput and design specifications and developing from these all the necessary information to fabricate or construct a system which meets these requirements. Only box 3 "Define Module Systems" is further expanded; see the STEP Petro-Chemical Design model for expansion of the other activities shown here.

3. Define Module Systems, model A3

Given a module definition and the constraints imposed by the design specification and project procedures, a module may be decomposed into a number of discrete systems whose design is undertaken by small discipline based teams. For the purpose of this model only two types of systems are shown: piping systems and "other" systems. The latter include instrumentation, electrical, civil engineering and building systems.

The resulting module system definitions are a result of the combination of system definition documents and system functional diagrams (also referred to as Piping & Instrumentation Diagrams or P&IDs).

As with the previous model, only one activity is expanded, that represented by box 3, "Design Piping System".

4. Design Piping System, model A33

This model describes those activities which are supported by the Application Protocol; these are

¹ CADDETC Document number AT/90/0021

² Activity Model for Petro-Chemical Plant Design, version 1.2. ISO TC184/SC4/WG1 working document, January 14, 1990

represented by boxes 3, 4 and 5 and the information flows between these activities.

The aim of the Application Protocol is to support the exchange of data between dissimilar CAD systems such that the resulting received model may be used for the purposes of:

- Interference analysis (included in box 5)
- Connectivity checks (included in box 5)
- Generation of a basic parts list (derived from the piping system model and shown as an output from box 3)
- Graphic Presentation (included in box 4)
- Generation of simple design drawings or isometrics (box 4)
- Pipe bending instructions (included in the output from box 4 on model A0)
- Limited piping design (repositioning of components as part of the feedback loop labelled "Changes Required" between boxes 5 and 3)

5. Glossary

Define Functional Units

A functional unit is a section of plant designed to perform a specific operation.

Define Module Systems

The breaking down of a module into discipline areas which can be designed and controlled by a team of discipline experts.

Define Modules

A module is a subsection of a functional unit; the division of the functional unit into modules may be determined by function or by fabrication or construction requirements, e.g., size or weight. A 'spool' is another term for a module.

Design "Other" System

A placeholder for all the non-piping system design required in designing the complete plant or ship.

Design Piping System

Select, position, and logically connect the pipes, piping components (both "commodity" and "specialty"), and equipment items required for the transfer of working fluids within the plant or ship. The piping model may include such non-piping elements such as supports, damping, and insulation components required for the piping system.

Determine Systems Required

In defining module systems, perform a decomposition of the design specifications and the module definition so that tasks may be allocated to discipline teams to design each of the systems required.

Generate Design Data

Define the functional parameters and the piping specifications for a section of pipe designed to perform a particular function, together with the routing of that section of piping through the complete plant.

Generate Fabrication Specification

The production of all documentation in a contractual form required for the fabrication of a piping system and its associated components.

Incorporate Into Module System Definitions

Combine information in the form of discrete system definitions and required system functional diagrams in a single document or document set which fully meet the requirements on a Module System Definition.

Perform Engineering Analysis

Analyze the piping system for consistency, strength, etc. Such analyses are frequently performed using specialized software packages.

Perform Interface Checking

Check that all interfaces between sections of piping and vessels are complete and that all piping supports have been incorporated.

Produce Design Drawings

Produce three-dimensional representations of the piping system model in which a standard symbology is used to represent pipes, components, etc. Symbols are rotated to show the orientation of components within the system, and all pipe lengths are dimensioned. These are the working documents for the fabrication of the piping system and are also referred to as "piping isometrics".

Produce Piping System Model

Develop a physical or computer-based model of the piping system design with sufficient information and detail to permit checks to be performed on the physical integrity of the design.

Produce System Functional Diagrams

Produce schematic topological representations of the piping components and instrumentation for a module of the plant or ship, together with the relationships and connections to other modules. System Functional Diagrams are also known as Piping and Instrumentation Diagrams (P&IDs).

USED AT:	AUTHOR: Julian Fowler	DATE: 9 May 1990	WORKING	READER	DATE	CONTEXT: none
	PROJECT: 3D Piping IGES AP	VERSION: 1.0	DRAFT			
	NOTES: 1 2 3 4 5 6 7 8 9 10		RECOMMENDED			
			PUBLISHED			

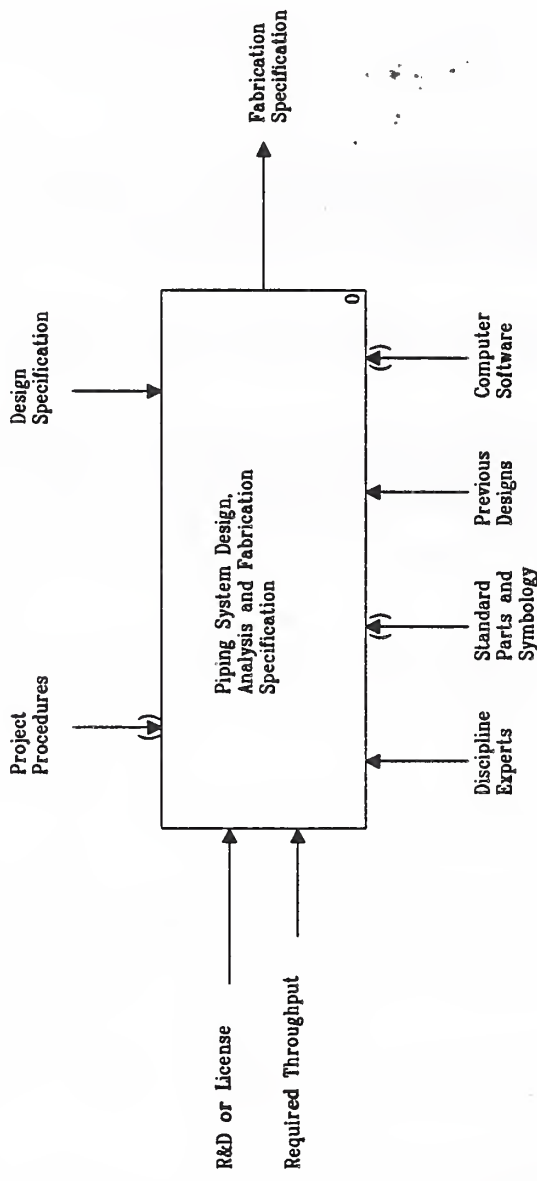

PURPOSE: Understand the tasks involved in performing the design, analysis and fabrication of piping systems found in petro-chemical plants and ships.

VIEWPOINT: Designer of the piping system.

NODE: A-0	TITLE: Piping System Design Overview	NUMBER: JF00
-----------	--------------------------------------	--------------

USED AT:	AUTHOR: Julian Fowler	DATE: 10 May 1980	WORKING	READER	DATE	CONTEXT: Top
	PROJECT: 3D Piping IGES AP	VERSION: 1.0	DRAFT			
	NOTES: 1 2 3 4 5 6 7 8 9 10		RECOMMENDED			
			PUBLISHED			

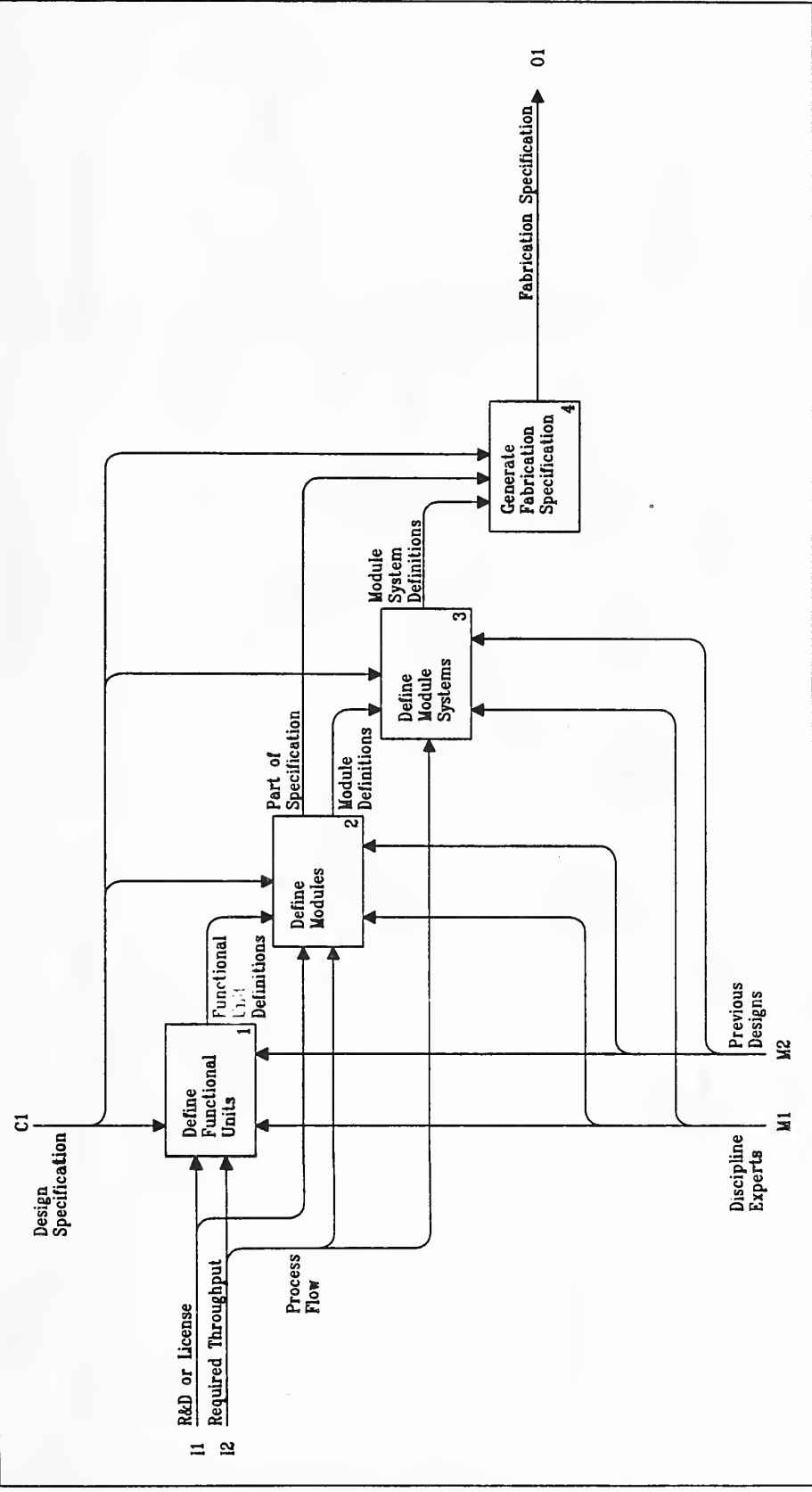

NODE: A0	TITLE: Piping System Design Overview	NUMBER: JF01
----------	--------------------------------------	--------------

USED AT:	AUTHOR: Julian Fowler	DATE: 10 August 1980	WORKING	READER	DATE	CONTEXT:
	PROJECT: 3D Piping IGES AP	VERSION: 1.1	DRAFT			
	NOTES: 1 2 3 4 5 6 7 8 9 10		RECOMMENDED			JF01
			PUBLISHED			

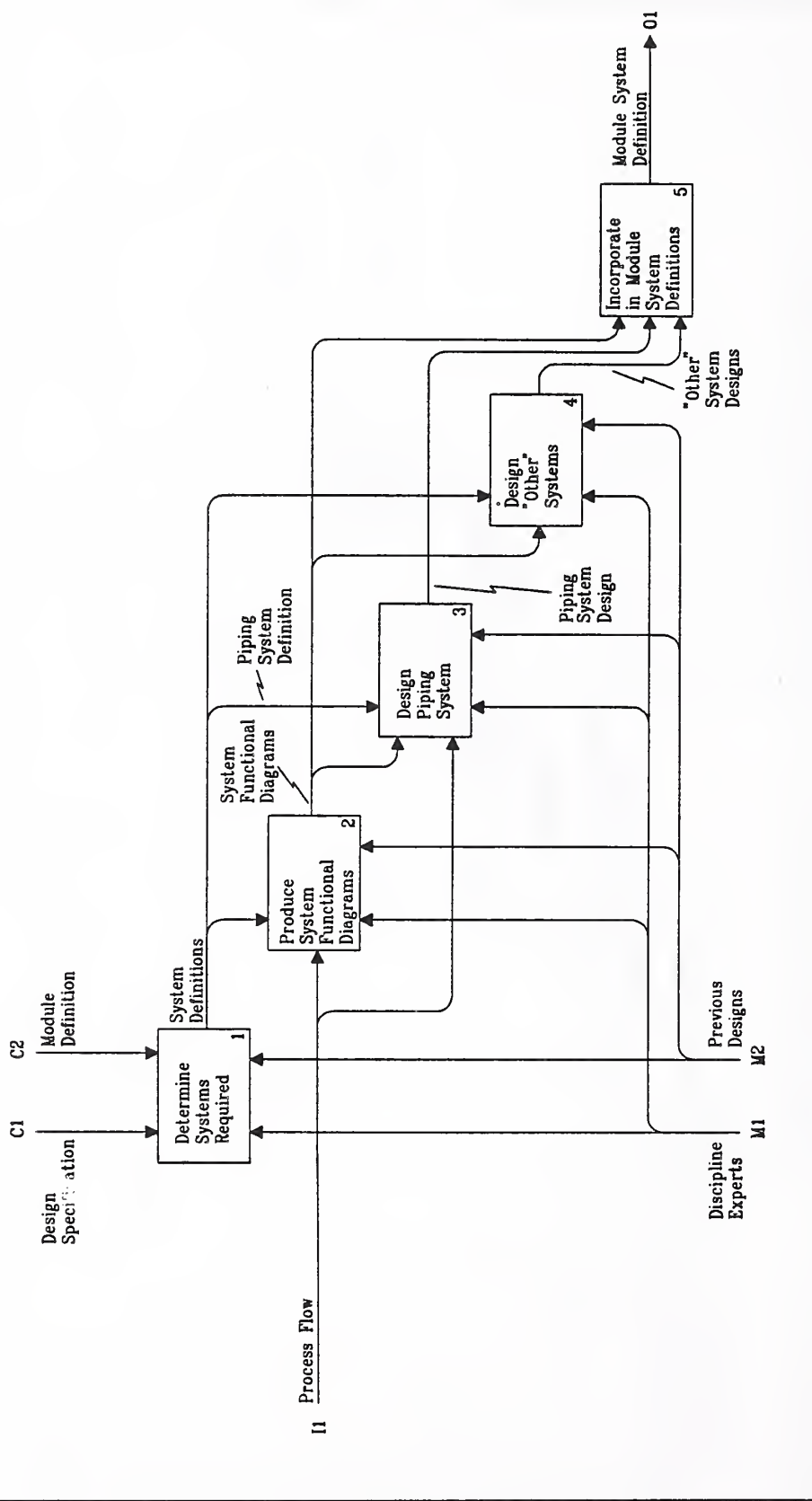

NODE: A3	TITLE: Define Module Systems	NUMBER: (JF02) JF06
----------	------------------------------	---------------------

USED AT: _____ AUTHOR: Julian Fowler DATE: 10 August 1990 READER _____ CONTEXT: _____
 PROJECT: 3D Piping IGES AP VERSION: 1.1 WORKING _____ DRAFT _____ JF06
 NOTES: 1 2 3 4 5 6 7 8 9 10 PUBLISHED _____ RECOMMENDED _____

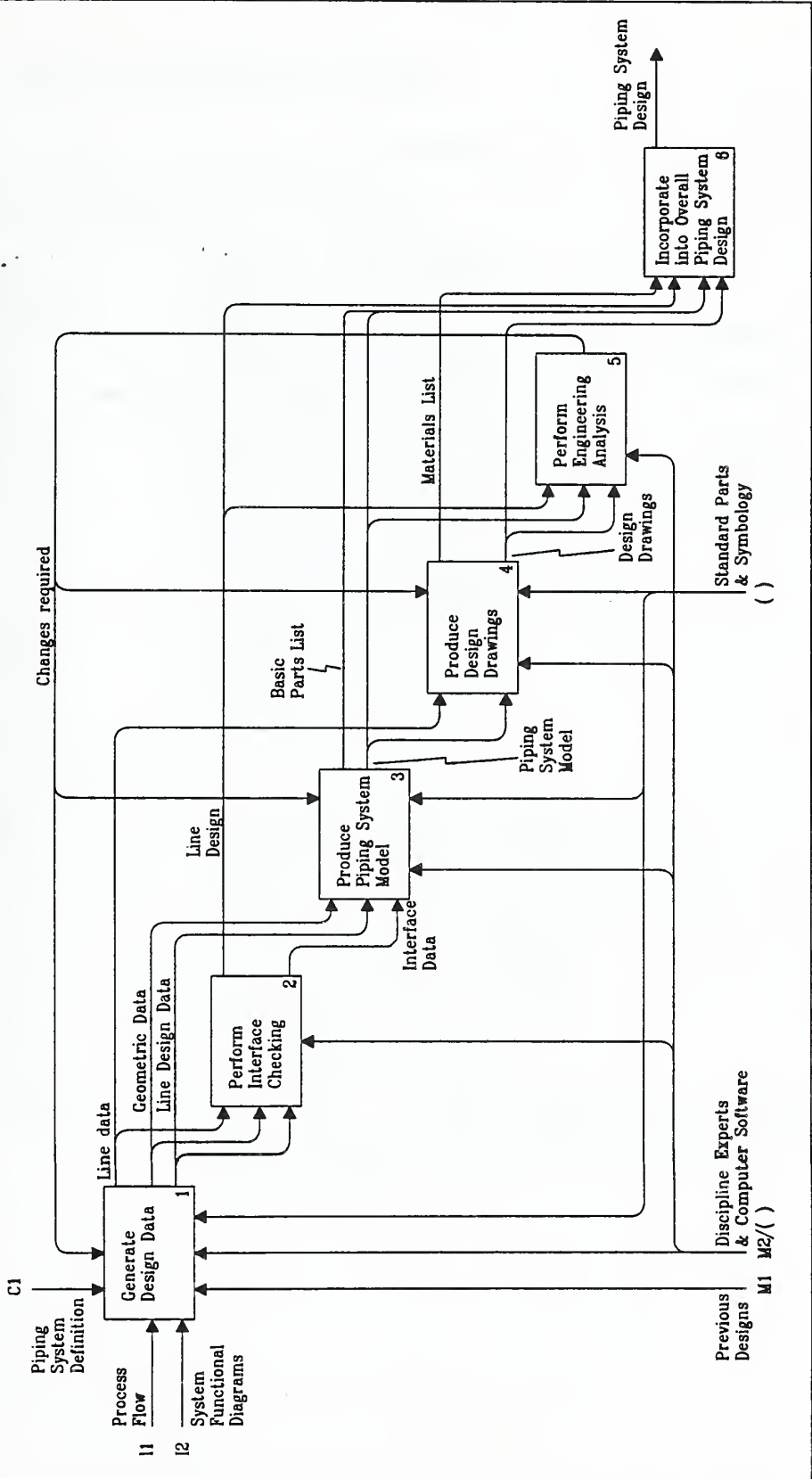

NODE: A33 TITLE: Design Piping System NUMBER: (JF04) JF07

APPENDIX B. PIPING SYSTEM EXAMPLE

This section defines an example piping system model and some different views of the piping model.

Description of components in the piping model:

1. Flange 3", weld neck, 150#, raised face, 1" insulation.
2. Pipe 3", butt weld, 1" insulation.
3. Support location at which support attaches to pipe.
4. Bend 3", 90 degree, 5 diameter butt weld bend, 1" insulation.
5. Pipe 3", butt weld, 1" insulation.
6. Bend 3", 90 degree, 5 diameter butt weld bend, 1" insulation.
7. Pipe 3", butt weld, 1" insulation.
8. Support location at which support attaches to pipe.
9. Branch tee with 3" branch and 3" runs, butt weld, 1" insulation.
10. Pipe 3", butt weld, 1" insulation.
11. Reducer 3" to 2.5" eccentric reducer, butt weld, flat on top, 1" insulation.
12. Pipe 2.5", butt weld, 1" insulation.
13. Elbow 2.5", 90 degree, long radius.
14. Pipe 2.5", butt weld, 1" insulation.
15. Flange 2.5", weld neck, raised face, 1" insulation.
16. Gasket 1/8" thick.
17. Pump Dimensions as shown.
18. Gasket 1/8" thick.
19. Flange 3", weld neck, raised face.
20. Pipe 3", butt weld.
21. Instrument
22. Tap 1", socket weld, 3000#, pipe tap.
23. Pipe 1", socket weld, 3000#, 1" insulation.
24. Elbow 1", socket weld, 3000#, 90 degree, 1" insulation.
25. Pipe 1", socket weld, 3000#, 1" insulation.
26. Valve 1", socket weld, 300#, steel, globe valve, 1" insulation.
27. Pipe 1", socket weld, 3000#, 1" insulation.
28. Elbow 1", socket weld, 3000#, 90 degree, 1" insulation.
29. Pipe 1", socket weld, 3000#, 1" insulation.
30. Bend 3", butt weld, 90 degree, 5 diameter.
31. Pipe 3", butt weld.
32. Valve 3", butt weld, 300#, steel, globe valve.
33. Pipe 3", butt weld, 1" insulation.
34. Envelope Access envelope for additional equipment which is not shown. Envelope is 36" wide x 36" deep x 72" high. Bottom of envelope is flush with bottom of pump base plate. Center of envelope in top view is 33 5/16" to the right of centerline of unattached end of valve 32.

Special Features of Piping Arrangement:

1. Insulation on pieces 28 and 29 overlaps insulation on pieces 9 and 33 to permit check of interference detection.
2. Pieces 23, 24, and 25 are inside access envelope 34 to permit check of interference detection.
3. Pieces 2, 4, 5, 6, 7 and 20, 30, 31 are configured for pipe bending machine to permit check of bending capability.
4. Piece 21 taps into line at a location determined by the user when the model was created to permit check of non-catalog port location.
5. Piece 22 taps into the line at a location determined by the user when the model was created to permit check of non-catalog port location.
6. Pieces 3 and 8 are support attachment points at locations determined by the user when the model was created to permit check of support attachment point translation.
7. Piece 17 is an item of equipment to allow check of equipment translation.
8. No misalignments or component end connection compatibility problems are included in the model.

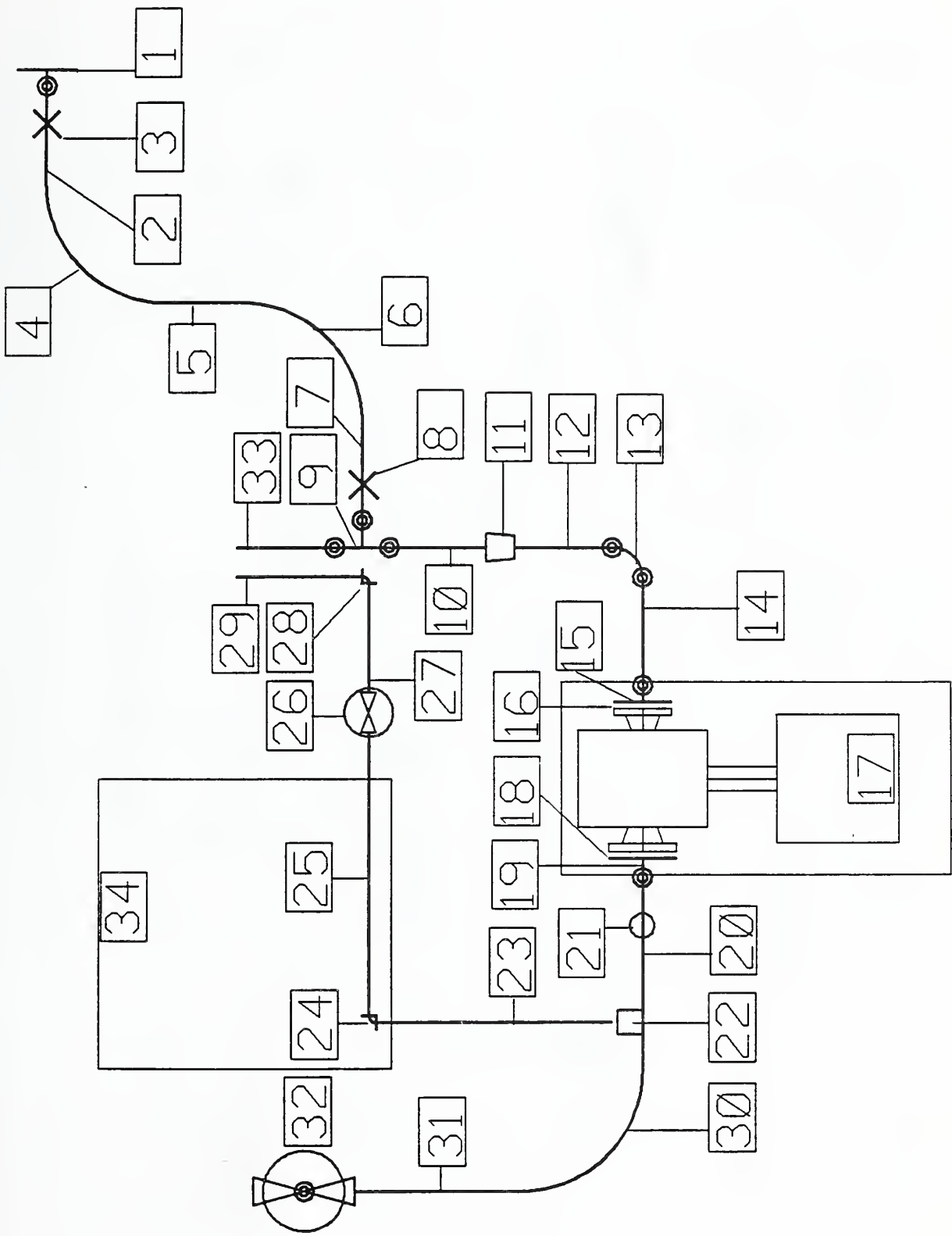

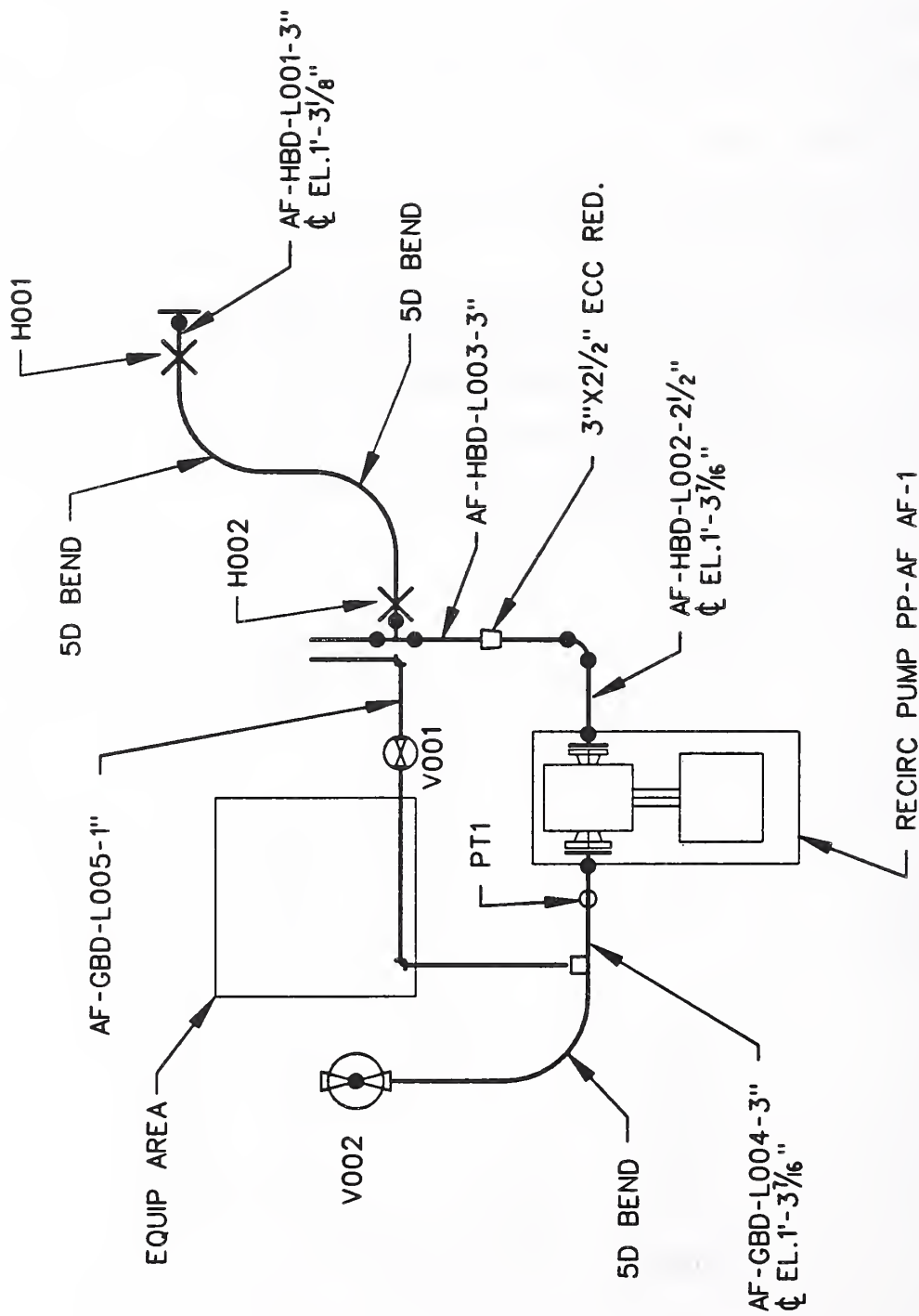

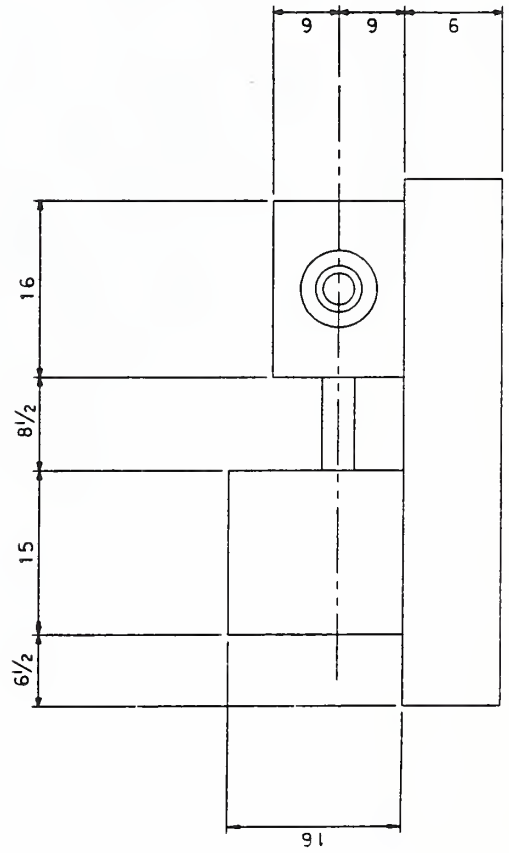
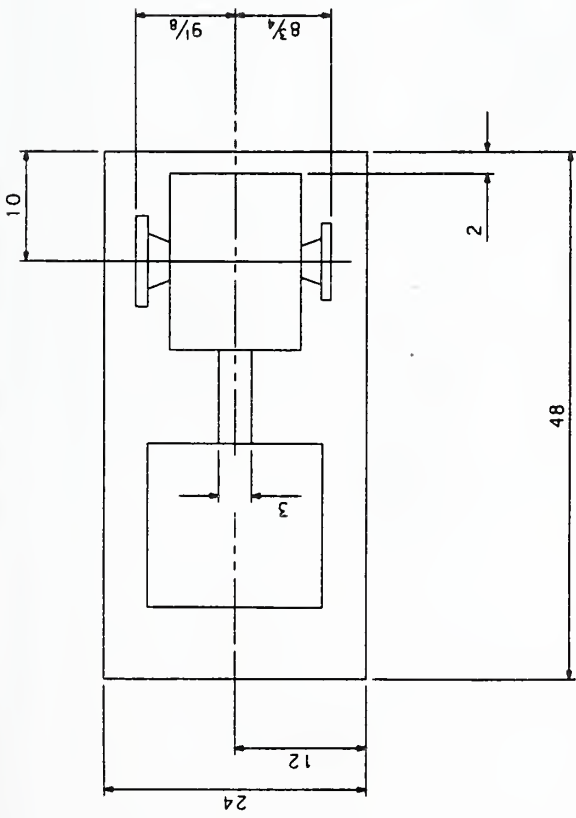
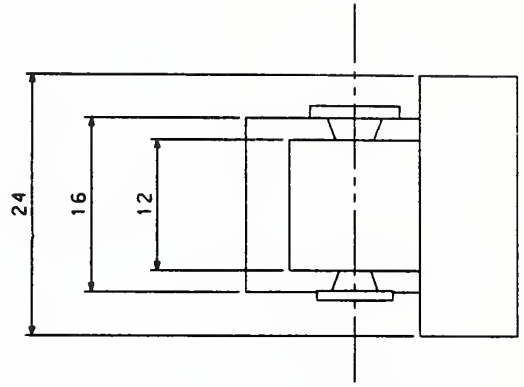
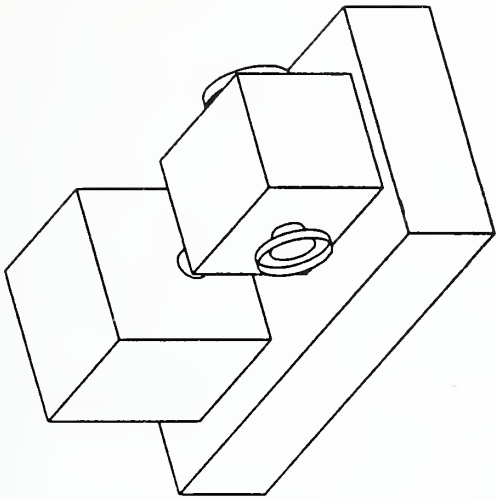

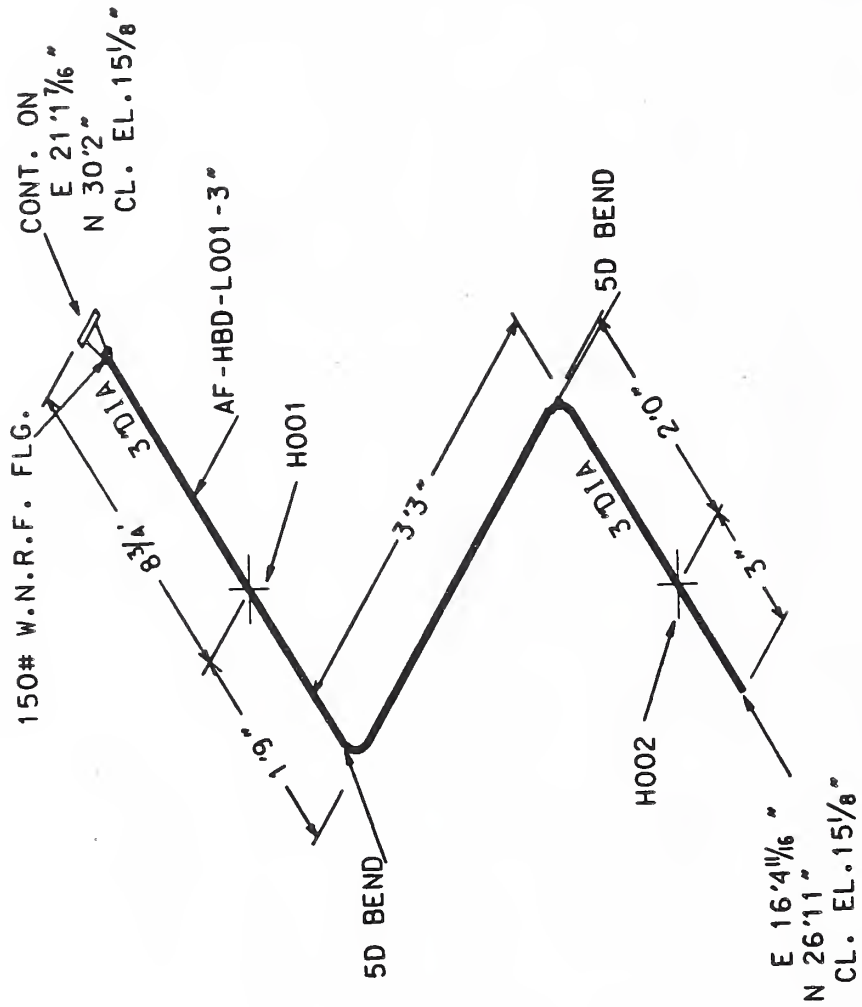

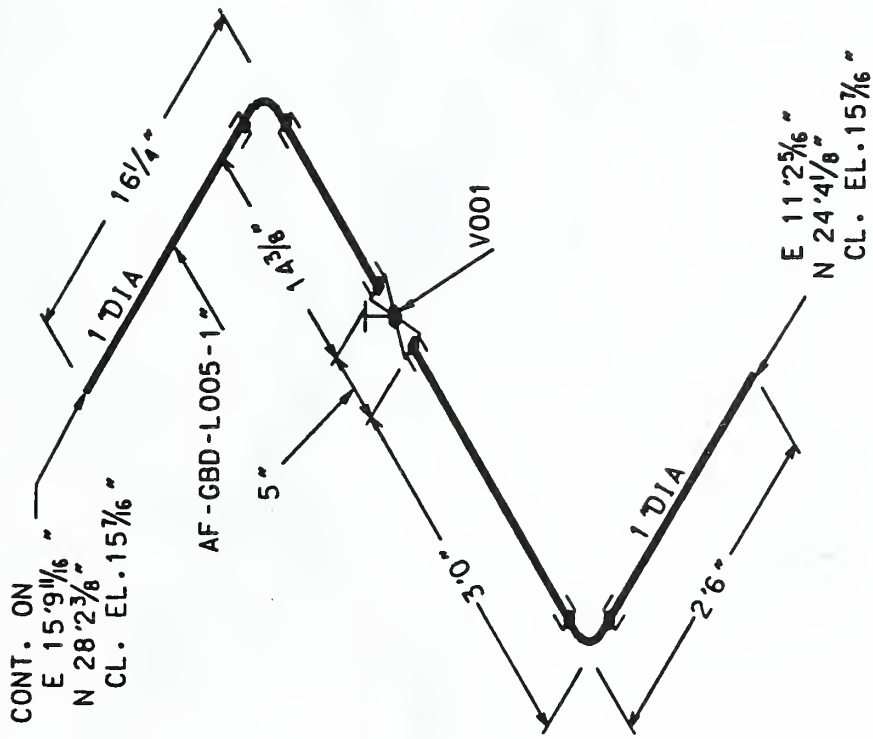

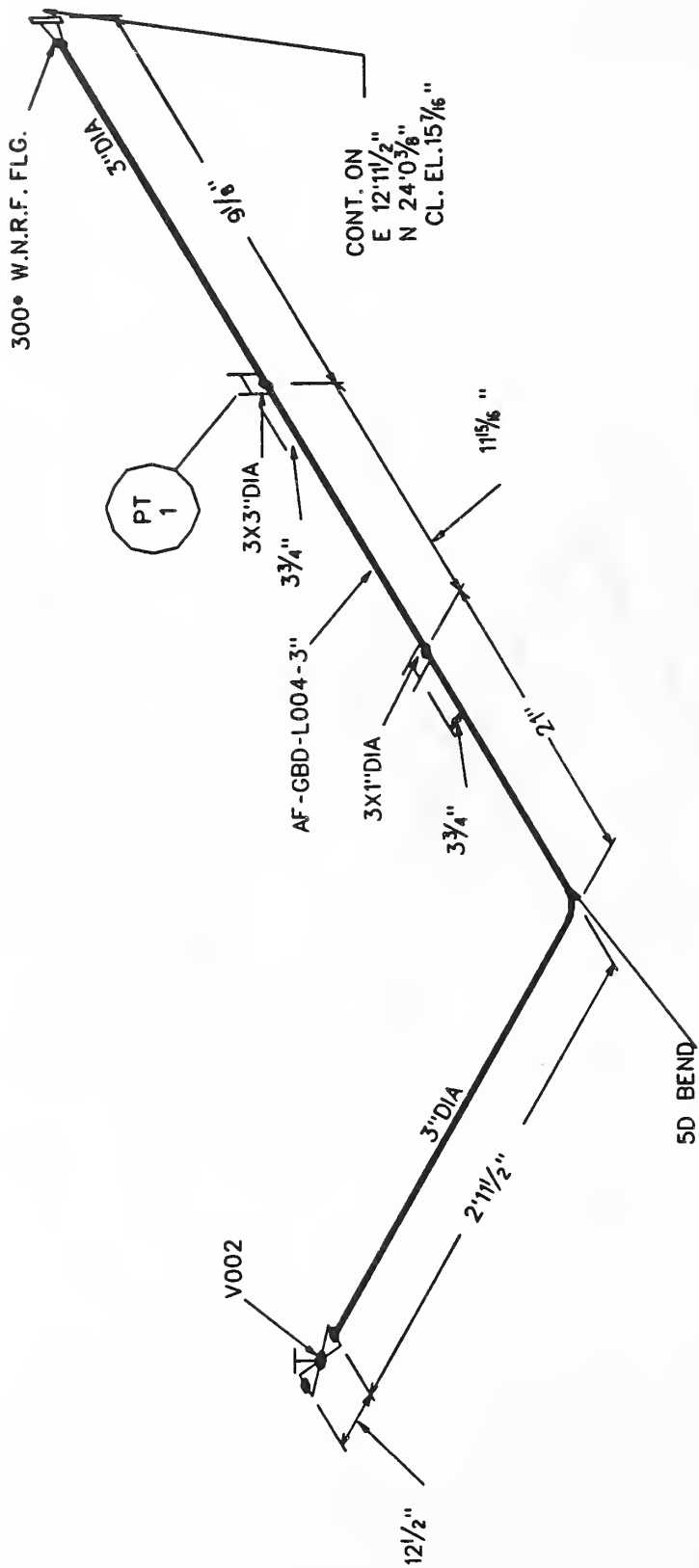

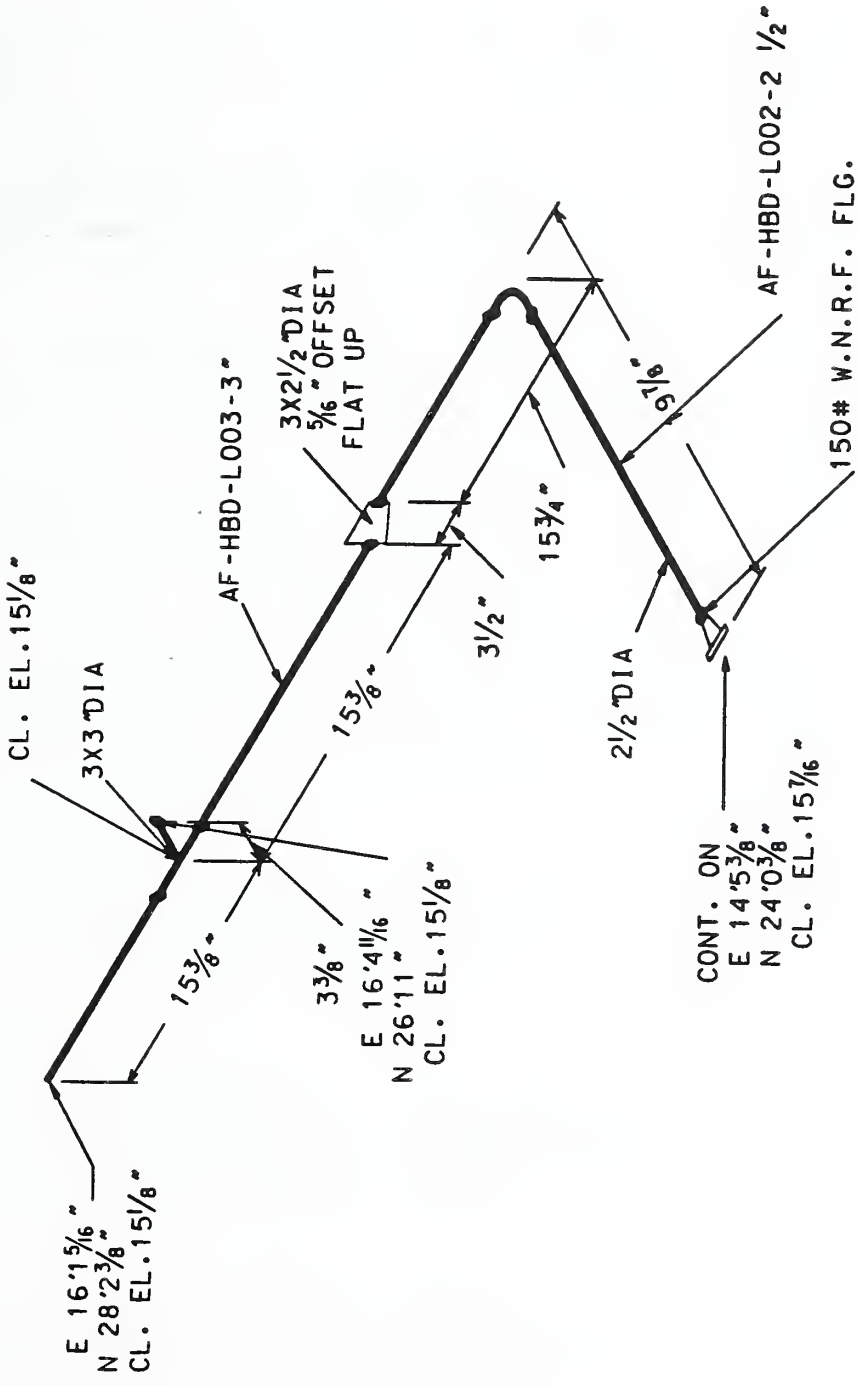

APPENDIX C. GUIDE TO READING NIAM DIAGRAMS

Guide to Reading NIAM Diagrams

The following is a definition of the symbols used in the Nijssen Information Analysis Method of binary relationship or binary semantic modeling. The notation consists of symbols for objects, roles between objects, and object and role constraints.

Object

Objects are tangible or abstract entities in an enterprise.



NOLOT – Non-Lexical Objects represent a set of non-representable entities having common properties. The symbol for a NOLOT is a solid circle containing the NOLOT name.



LOT – Lexical Objects represent a set of values of an entity, such as names and properties. The symbol for a LOT is a dashed circle containing the LOT name.



MODEL – The main NOLOT of the model. The remainder of the model usually supports its definition. The symbol for a MODEL is a heavy dashed circle containing the MODEL name. This is a NIAM extension.



CLONE — An object that occurs elsewhere on this or another NIAM model. Square may enclose either a LOT or NOLOT. This is a NIAM extension



CLONE — An object that occurs on a NIAM model in another document. Square may enclose either a LOT or NOLOT. This is a NIAM extension

Role

The relationship or association between two objects is called a **ROLE**. Role names are read as A-R1-B and B-R2-A, or members of A "play" role R1 with members of B and members of B play role R2 with members of A. Roles act as a relation between the members of A and B:

R1: A -> B
R2: B -> A

The set of occurrences of role R1 is equal to the subset of the cartesian product of A and B for which the role A-R1-B is true.

A role is shown as a divided box attached to the affected objects with solid lines. The role names, or phrases, are written either inside each box or outside the boxes and attached with a leader line.

If one of the role names is omitted, the missing co-role is assumed to be the inverse of the existing role.

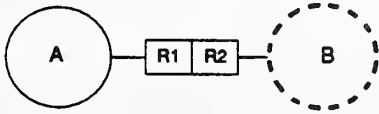

BRIDGE – A role between a NOLOT and a LOT.

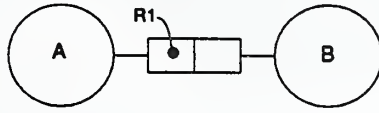

IDEA – A role between two NOLOTs.

Object Subtypes

Object subtyping is a method to describe the characteristics of the subsets of a NOLOT.

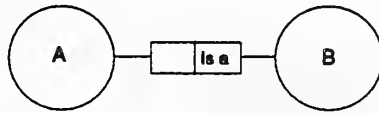

The "IS A" role is a common relationship between NOLOTs. As a result, a special symbol – a directed line segment – is provided. The arrow from B to A designates object B as a **SUBTYPE** of supertype object A, or set B is a **SUBSET** of set A.

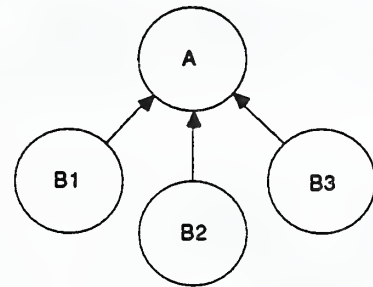
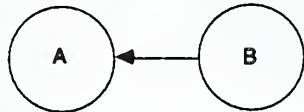

SUBTYPE, SUBSET – B1, B2 and B3 are **SUBSETS** or **SUBTYPES** of A. Each member of A may be a member of B1, B2, B3, or any other subset of A. Or a member of A may be a member of any combination of B1, B2 and B3.

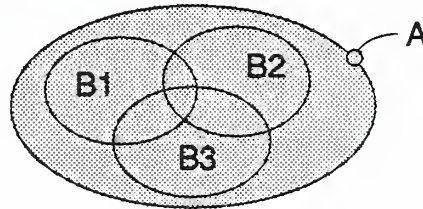

Subtype Constraints

Subtype constraints are rules which restrict the division of a NOLOT into subsets. Subtypes are shown as a line connecting all affected subtype lines (arrowhead) with a circled letter superimposed. The letter designates the type of constraint.

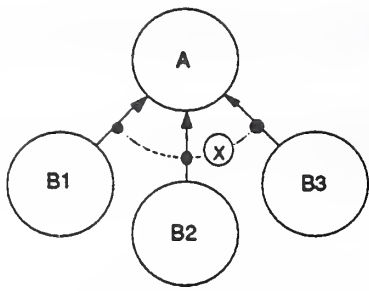

MUTUAL EXCLUSION – Each member of A can be a member of B1, B2, B3, or another subtype of A. B1, B2, and B3 are disjoint.

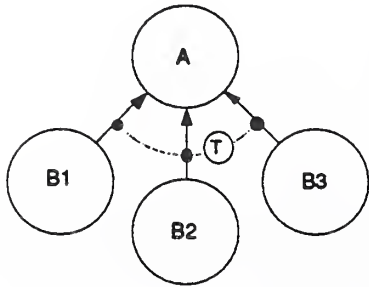
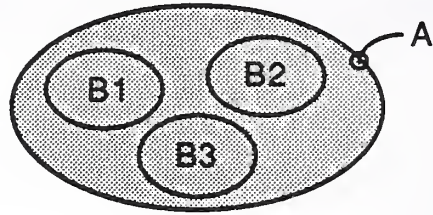

TOTAL – Each member of A must be a member of B1, B2, or B3; there are no other subtypes of A. Each member of A can be a member of more than one of the subtypes. B1, B2, and B3 may intersect.

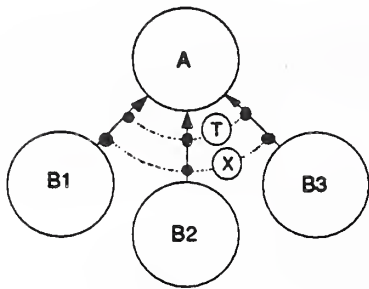
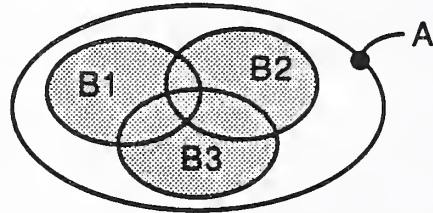

TOTAL MUTUAL EXCLUSION – Each member of A can either be in B1, B2, or B3; there are no other subtypes of A. B1, B2, and B3 are disjoint.

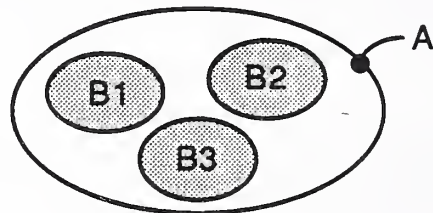

Cardinality Constraints

Cardinality constraints designate the quantities of objects and roles allowed in a role.

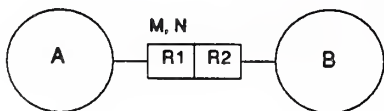

ROLE CARDINALITY – is shown as a minimum and maximum number above the affected role. Here, members of set A play between M and N roles R1 with members of B.

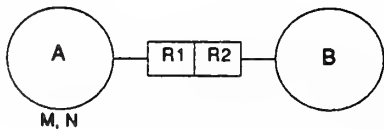

OBJECT CARDINALITY – is shown as a minimum and maximum number placed outside the affected object. Here, between M and N members of set A play role R1 with members of B.

Idea Constraints

Idea constraints are restricting rules on roles between NOLOTs and are used to define the semantics of the relationships between objects. Idea constraints are divided into UNIQUENESS and TOTAL constraints.

A UNIQUENESS constraint is drawn as a line above or below the role. The line may or may not have arrowheads drawn at both ends.

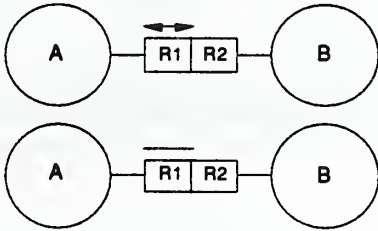

UNIQUENESS – Each member of A plays role R1 with zero or one member of B. Each member of B plays role R2 with zero, one, or many members of A.

This constraint defines R1 as an identifying role of A.

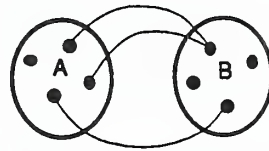

Many to one mapping

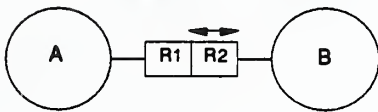

UNIQUENESS – Each member of B plays role R2 with zero or one member of A. Each member of A plays role R1 with zero, one, or many members of B.

This constraint defines R2 as an identifying role of B.

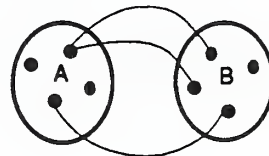

One to many mapping

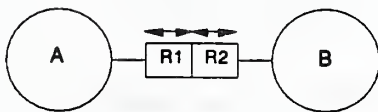

UNIQUENESS – Each member of A plays role R1 with zero or one member of B. Each member of B plays role R2 with zero or one member of A.

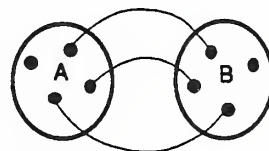

One to one mapping

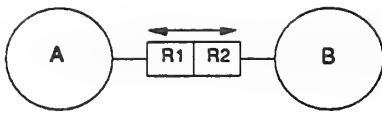

UNIQUENESS – Every member of A plays role R1 with zero or many members of B. Each member of B plays role R2 with zero or many members of A.

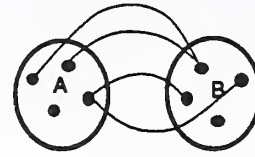

Many to many mapping

A **TOTAL** constraint is drawn as a "V" intersecting the line from the object to the role box, as a double line from the object to the role box, or as an upside-down "A" drawn above the constrained role.

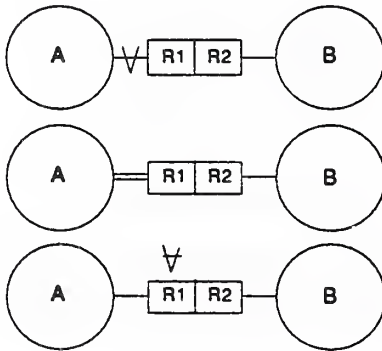

TOTAL – Each member of A plays role R1 with one or many members of B.

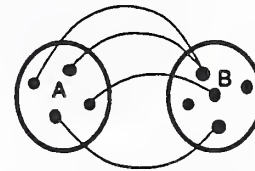

Combined Uniqueness and Total Constraints

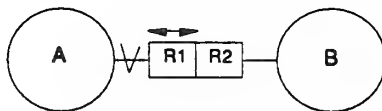

Each member of A plays role R1 with one and only one member of B. Each member of B plays role R2 with zero, one, or many members of A.

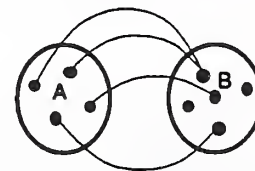

Total many to one mapping

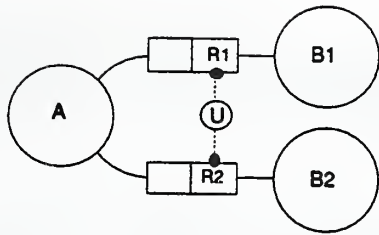

JOINT UNIQUENESS – A member of A is uniquely defined by a member of B1 playing role R1 and a member of B2 playing role R2.

Bridge Constraints

Bridge constraints are restricting rules on the roles between NOLOTs and LOTs. The symbols for bridge constraints are the same as the symbols for idea constraints.

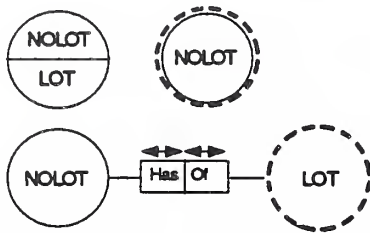

Often, a special object-type is provided for NOLOTs with a preferred one-to-one bridge to a corresponding LOT.

The symbol is either a divided solid circle with both the NOLOT and LOT name, or a solid circle containing the NOLOT name inscribed in a dashed circle.

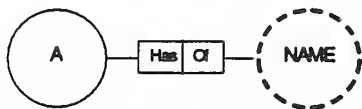

SYNO-HOMONYM – Each member of A has zero, one, or many NAMES. A name is of zero, one, or many members of A.

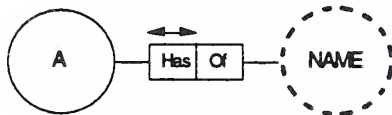

HOMONYM – Each member of A has zero or one NAME. A name is of zero, one, or many members of A.

Homonyms are identical terms which refer to different entities.

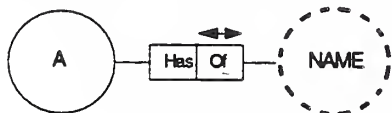

SYNONYM – Each member of NAME is of zero or one member of A. Each member of A has zero, one, or many names.

Synonyms are different terms which refer to the same entity.

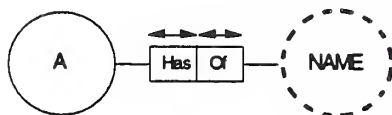

ONE-TO-ONE – Each member of A has zero or one NAME. Each NAME is of zero or one member of A.

Multiple Role Constraints

It is possible to provide restricting rules between roles. The rules and symbols are similar to those which govern and restrict set membership. Multiple role constraints are shown as a line between the affected role with a circle superimposed containing the constraint letter.

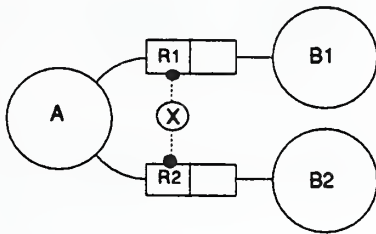

MUTUAL EXCLUSION – Each member of A which plays role R1 with members of B1 cannot play role R2 with members of B2. Members of A may play roles with other sets.

The set of occurrences of R1 and R2 must be disjoint.

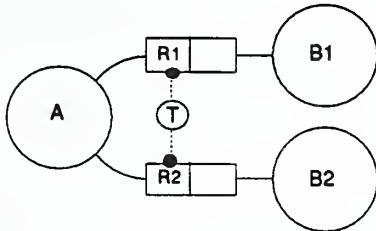

JOINT TOTAL – Members of A may play role R1 with members of B1. They may also play role R2 with members of B2.

The set of occurrences of R1 and R2 may intersect.

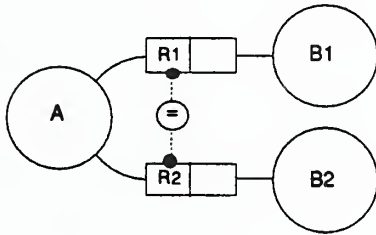

EQUALITY – Members of A which play role R1 with members of B1 must also play role R2 with members of B2.

The set of occurrences of roles R1 and R2 must be equal.

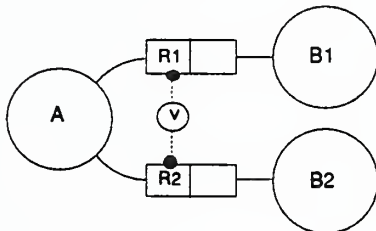

SUBSET – Members of A which play role R2 with members of B2 are a subset of the members of A which play role R1 with members of B1.

The set of occurrences of R2 is a subset of the set of occurrences of R1.

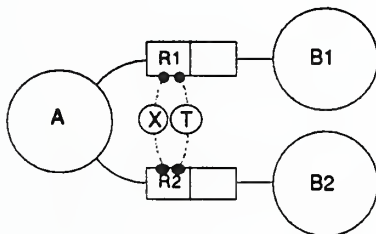

TOTAL MUTUAL EXCLUSION – A member of A can either play role R1 with a member of B1 or it can play role R2 with a member of B2.

The set of occurrences of R1 and R2 must not intersect.

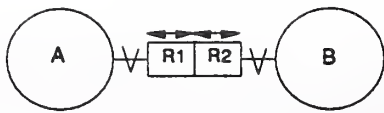

Each member of A plays role R1 with one and only one member of B. Each member of B plays role R2 with one and only one member of A.

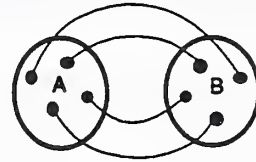

Total one to one mapping

APPENDIX D. 3D PIPING IGES AIM

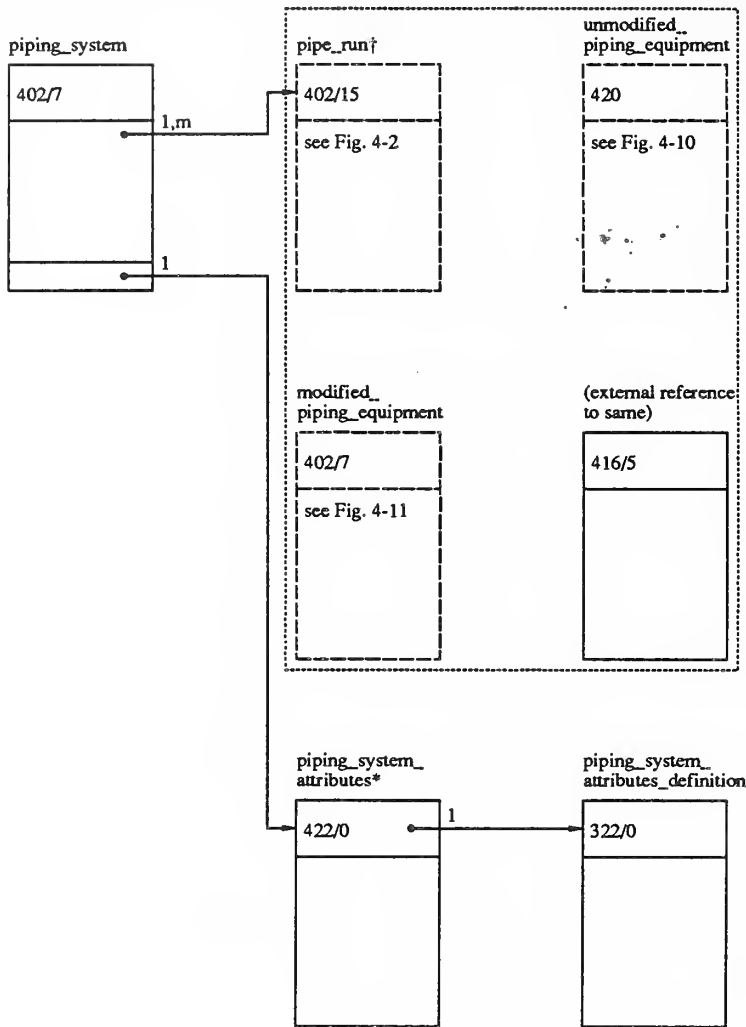

†Rule:
at least one pipe_run shall occur
in a piping_system structure

*Note:
piping_system_attributes are:
piping_object_type
piping_system_identifier

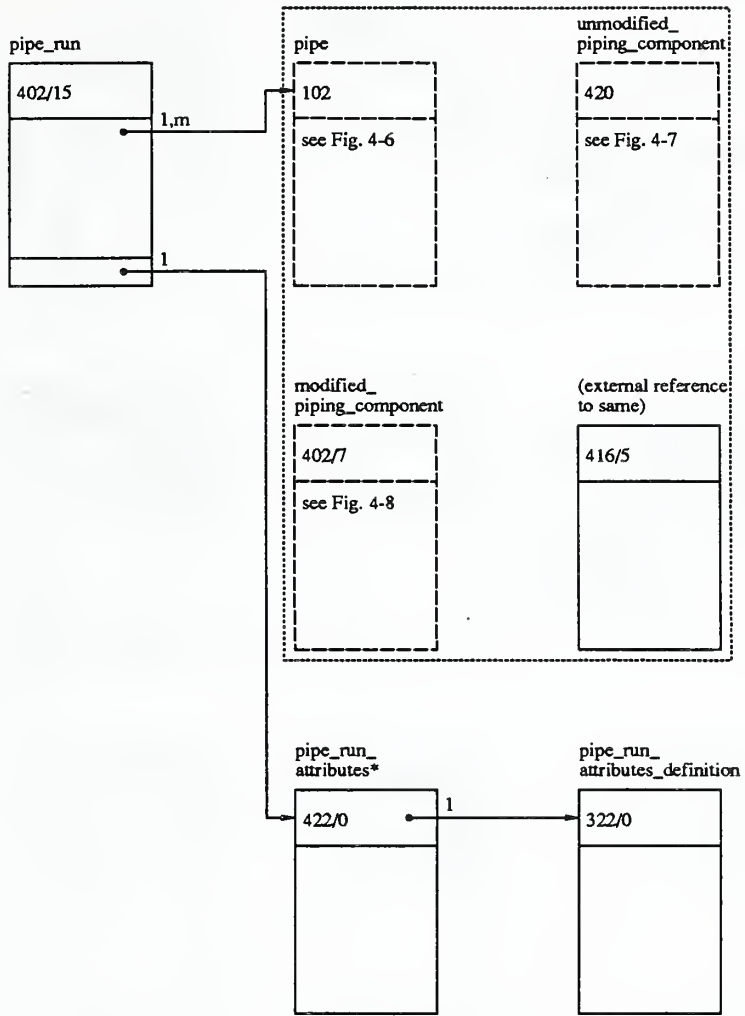

*Note:
 pipe_run_attributes are:
 piping_object_type
 pipe_run_identifier
 pipe_specification

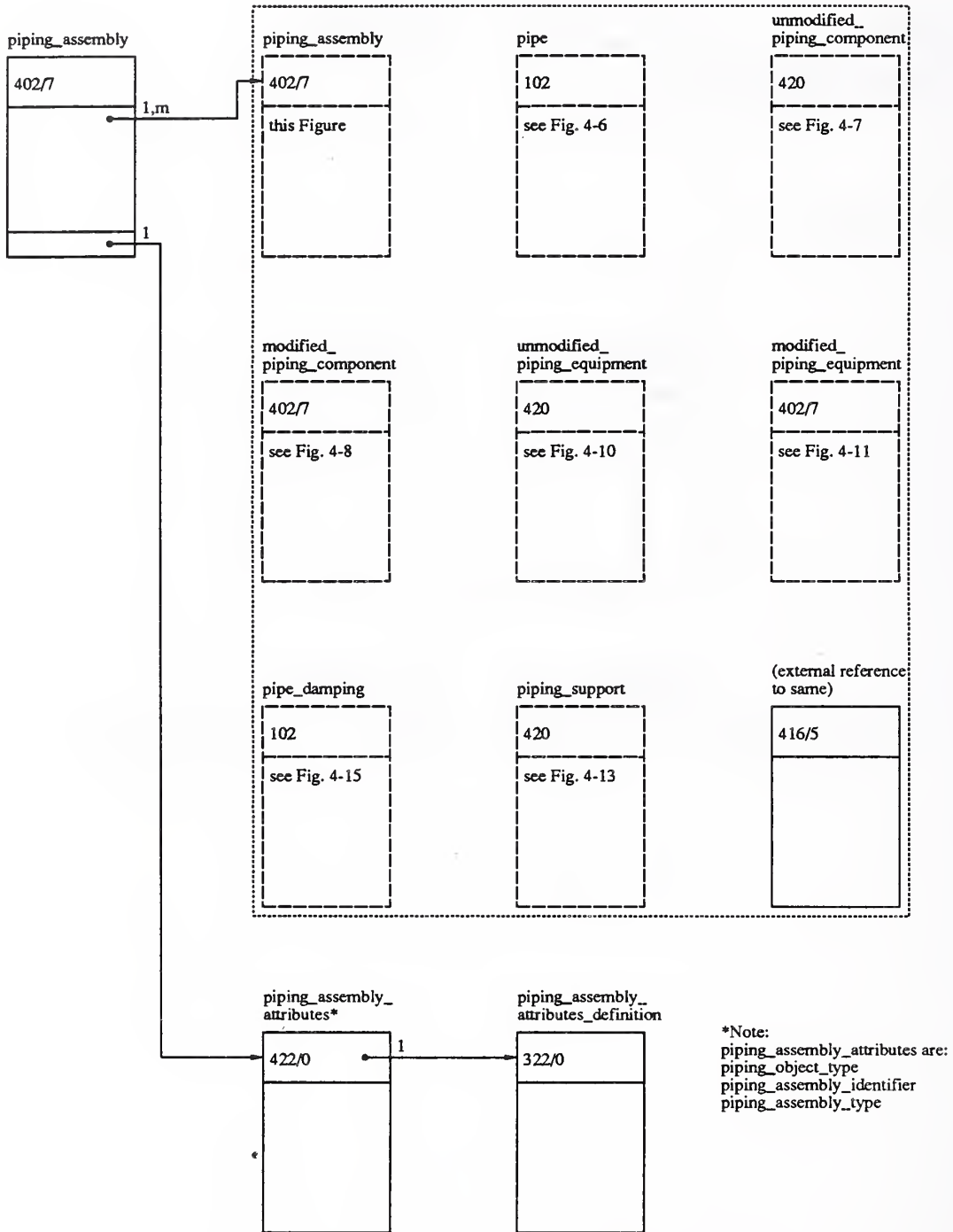

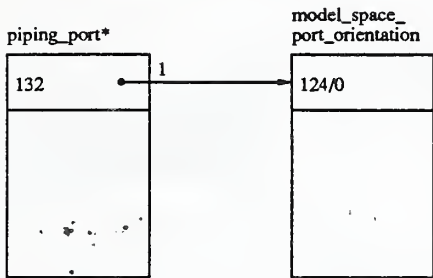

*Note:
 piping_port is one of:
 pipe_branch_port
 pipe_end_port
 piping_component_port
 added_piping_component_port
 piping_equipment_port

 piping_port contains model_
 space_location and the attributes:
 port_type
 port_label

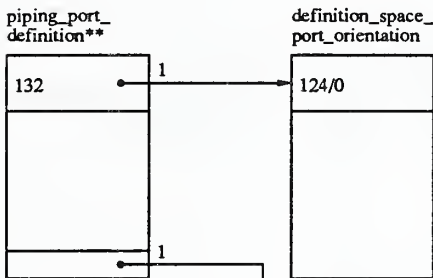

**Note:
 piping_port_definition is one of:
 piping_component_port_definition
 piping_equipment_port_definition

 piping_port_definition contains
 definition_space_location and
 the attributes:
 port_definition_type
 port_definition_label

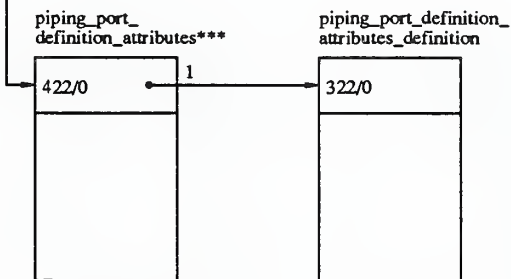

***Note:
 piping_port_definition_attributes are:
 end_preparation
 pressure_rating
 pressure_rating_units
 pipe_fit_up_length
 pipe_fit_up_length_units

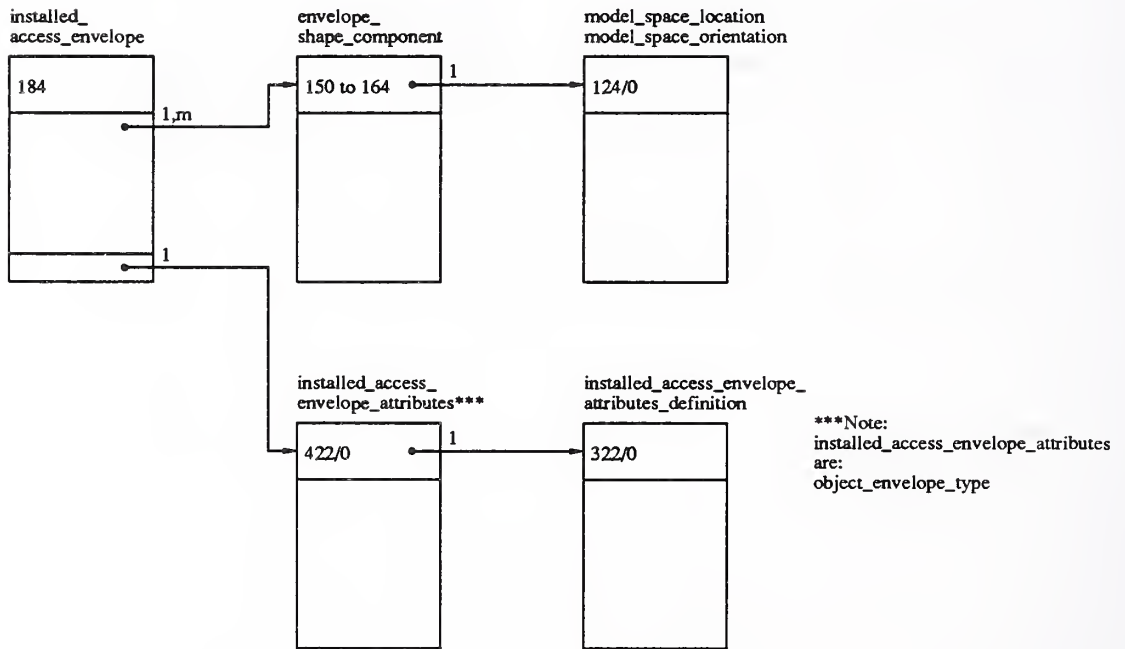
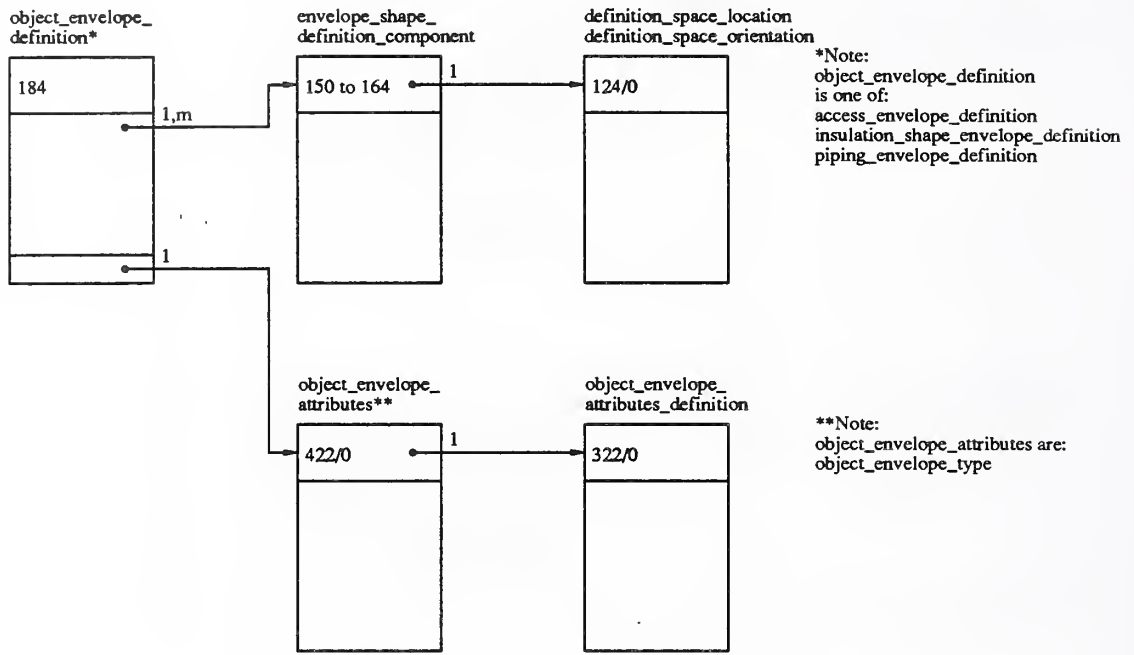

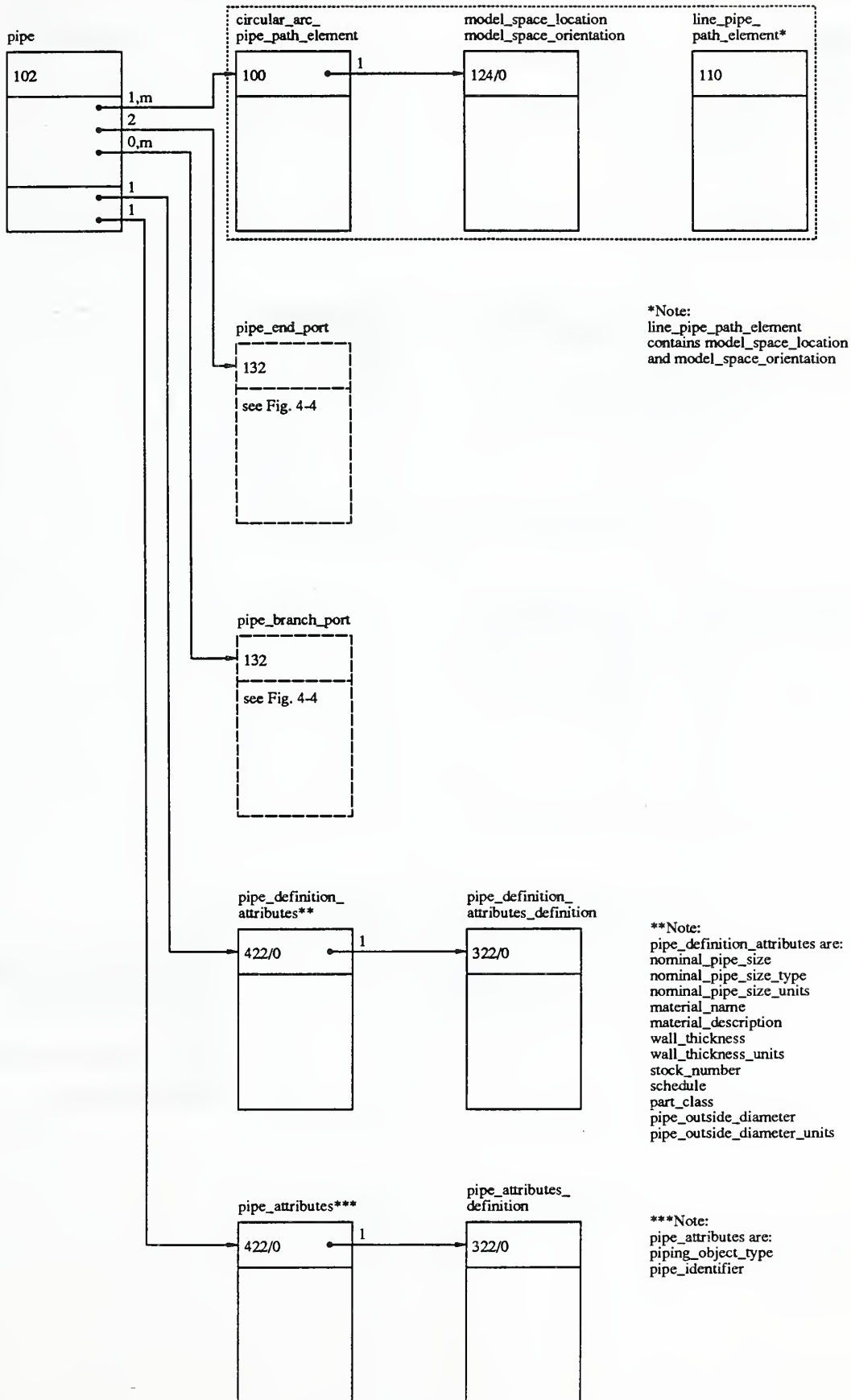

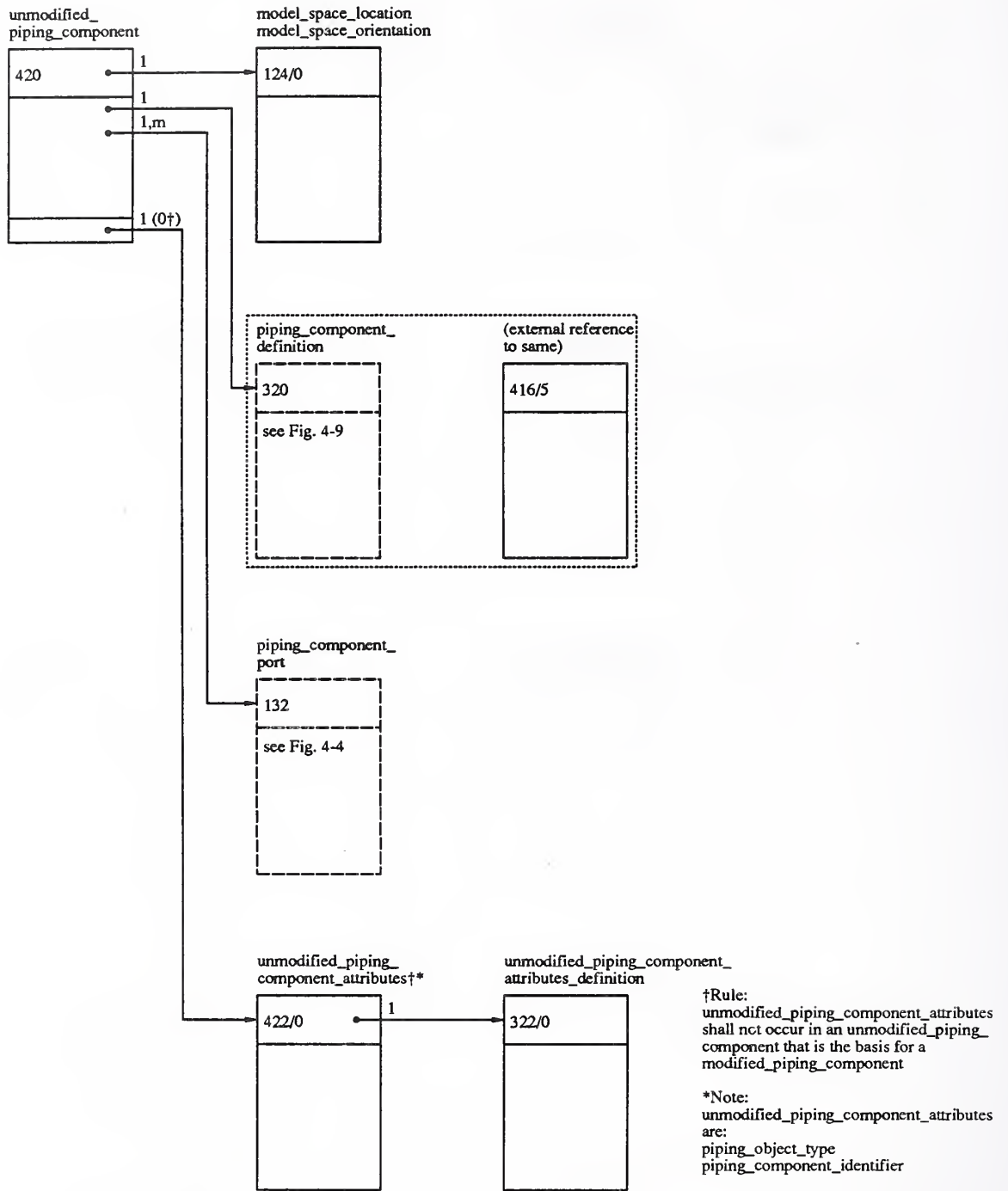

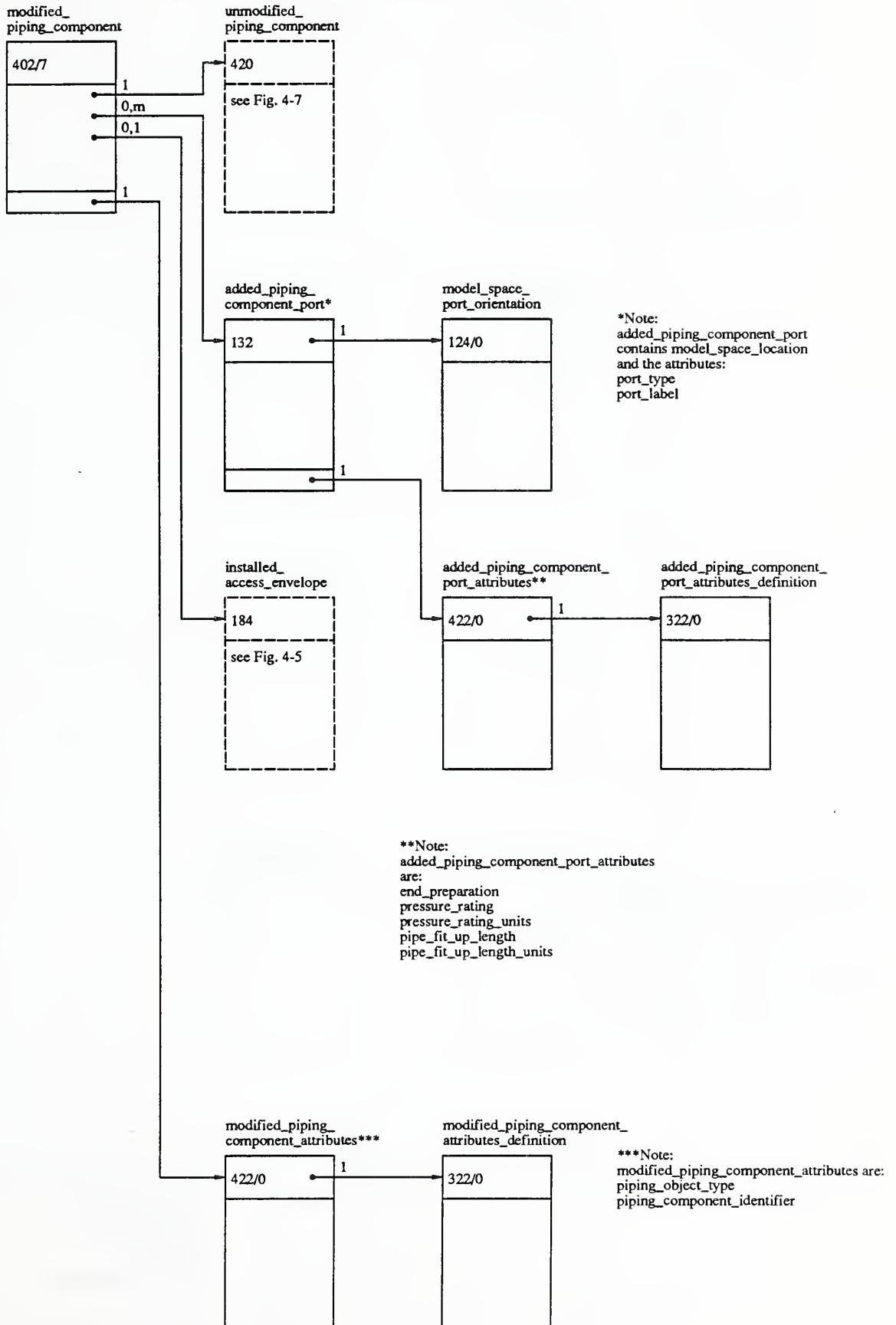

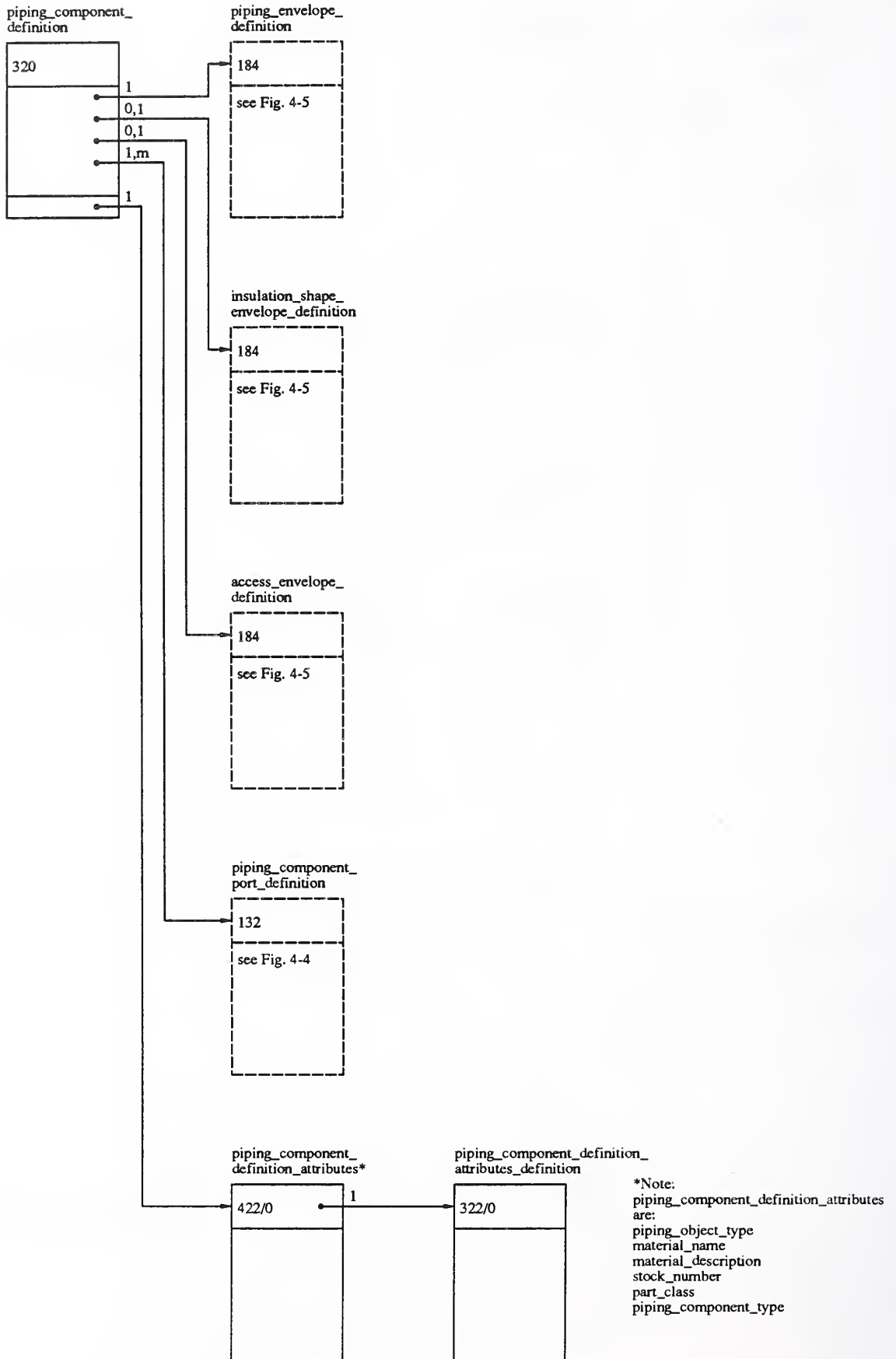

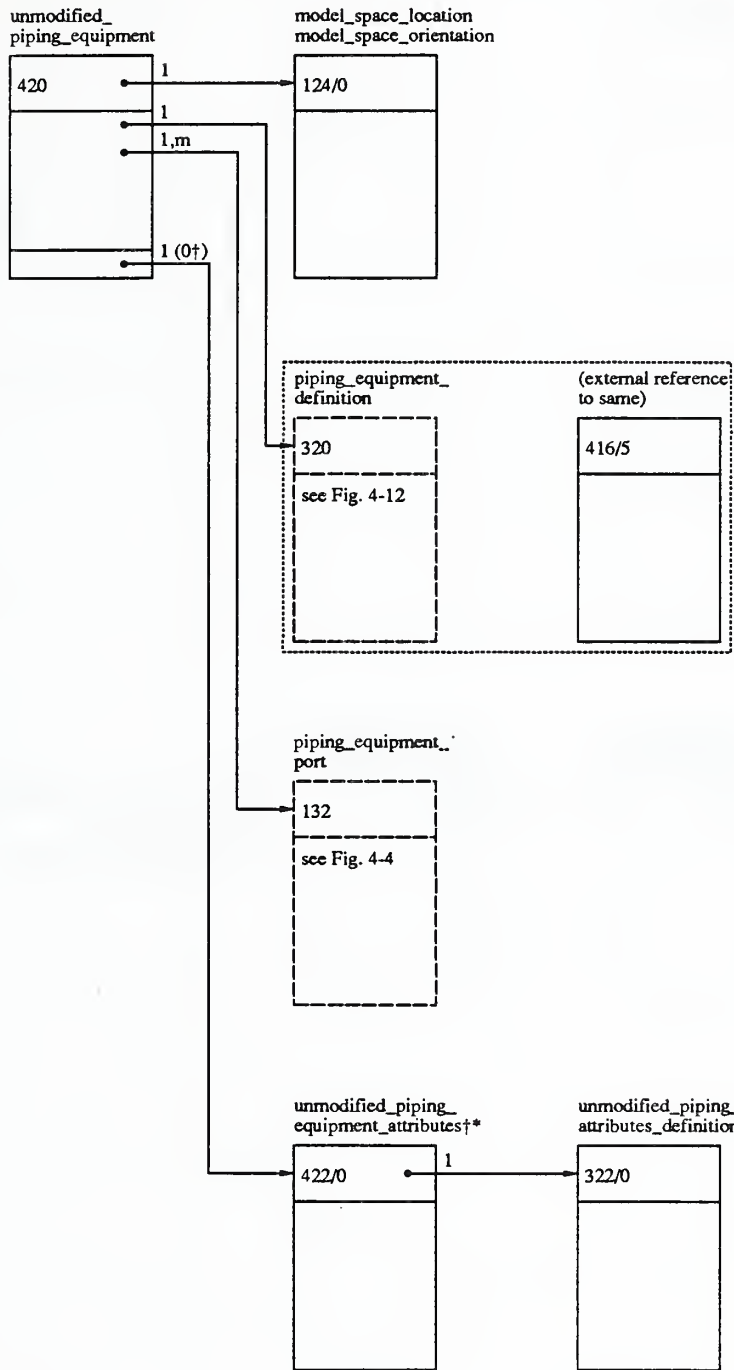

†Rule:
 unmodified_piping_equipment_attributes shall not occur in an unmodified_piping_equipment that is the basis for a modified_piping_equipment

*Note:
 unmodified_piping_equipment_attributes are:
 piping_object_type
 piping_equipment_identifier

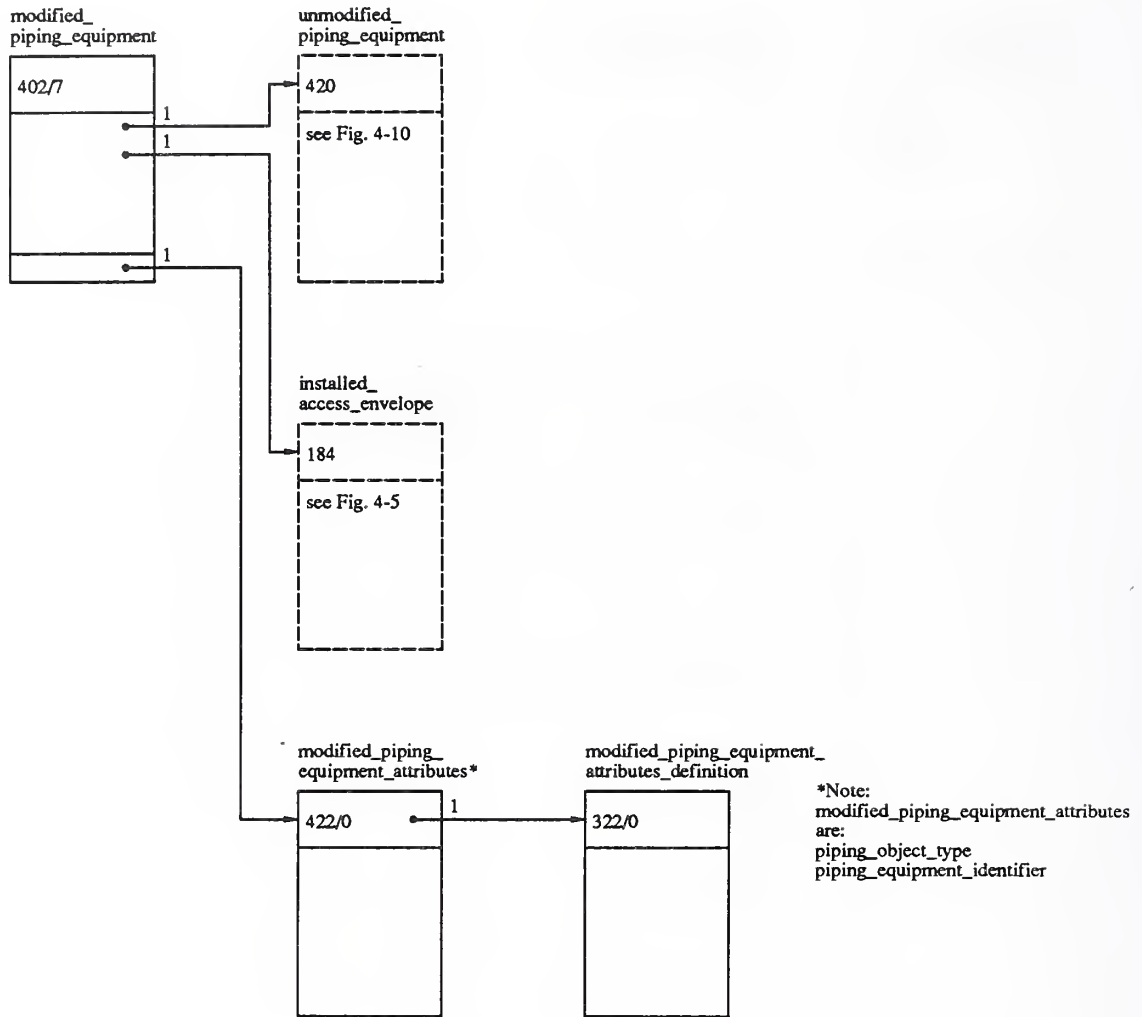

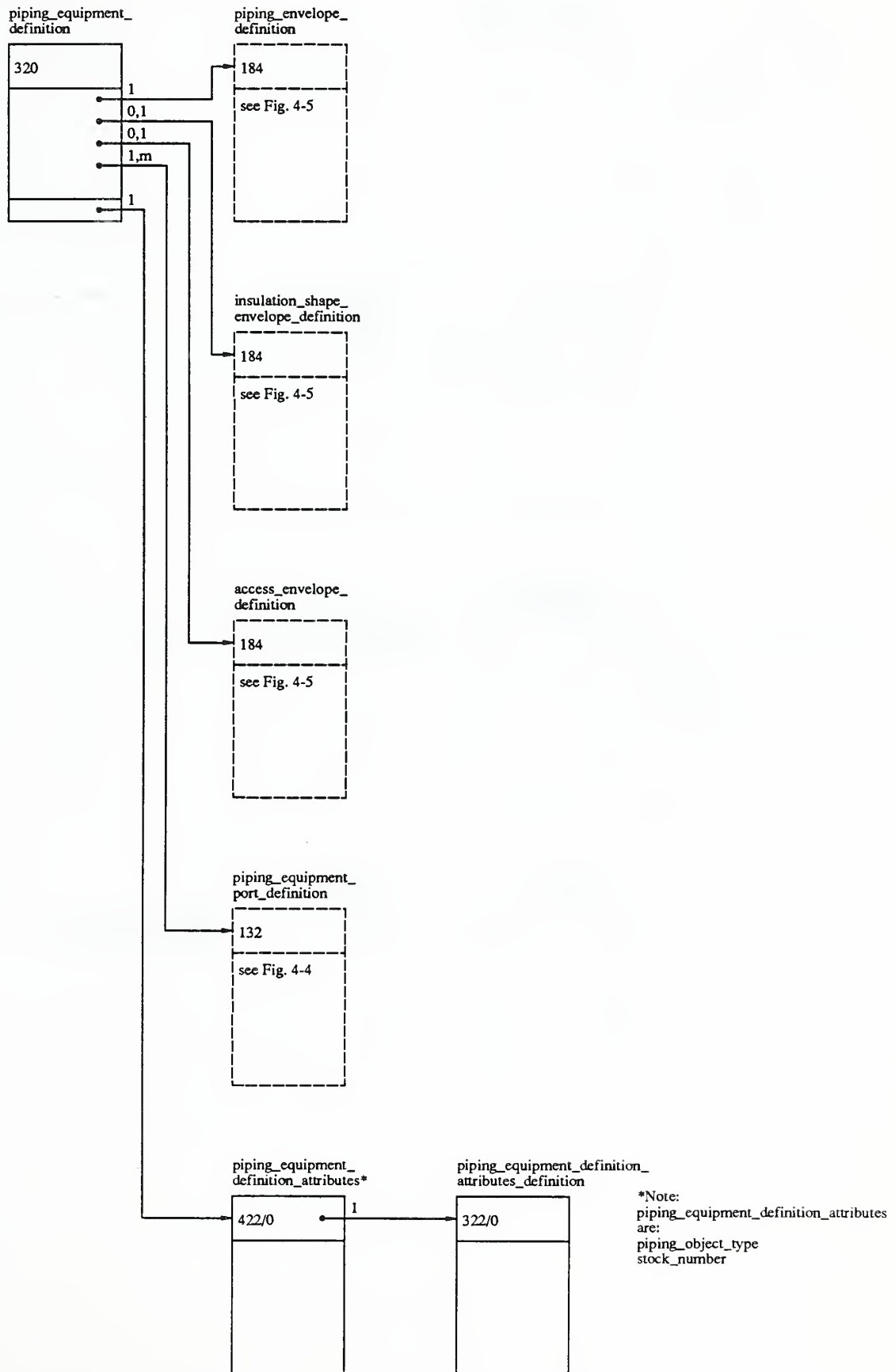

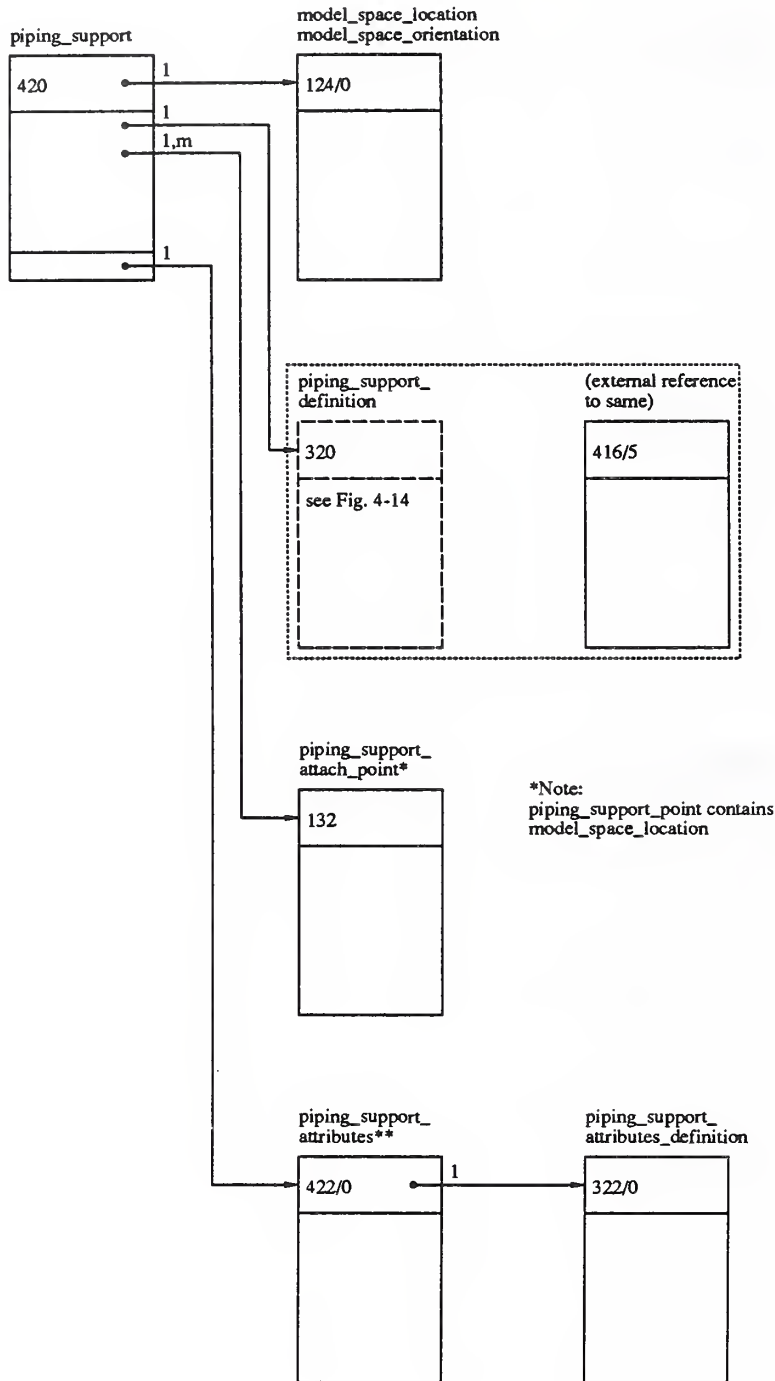

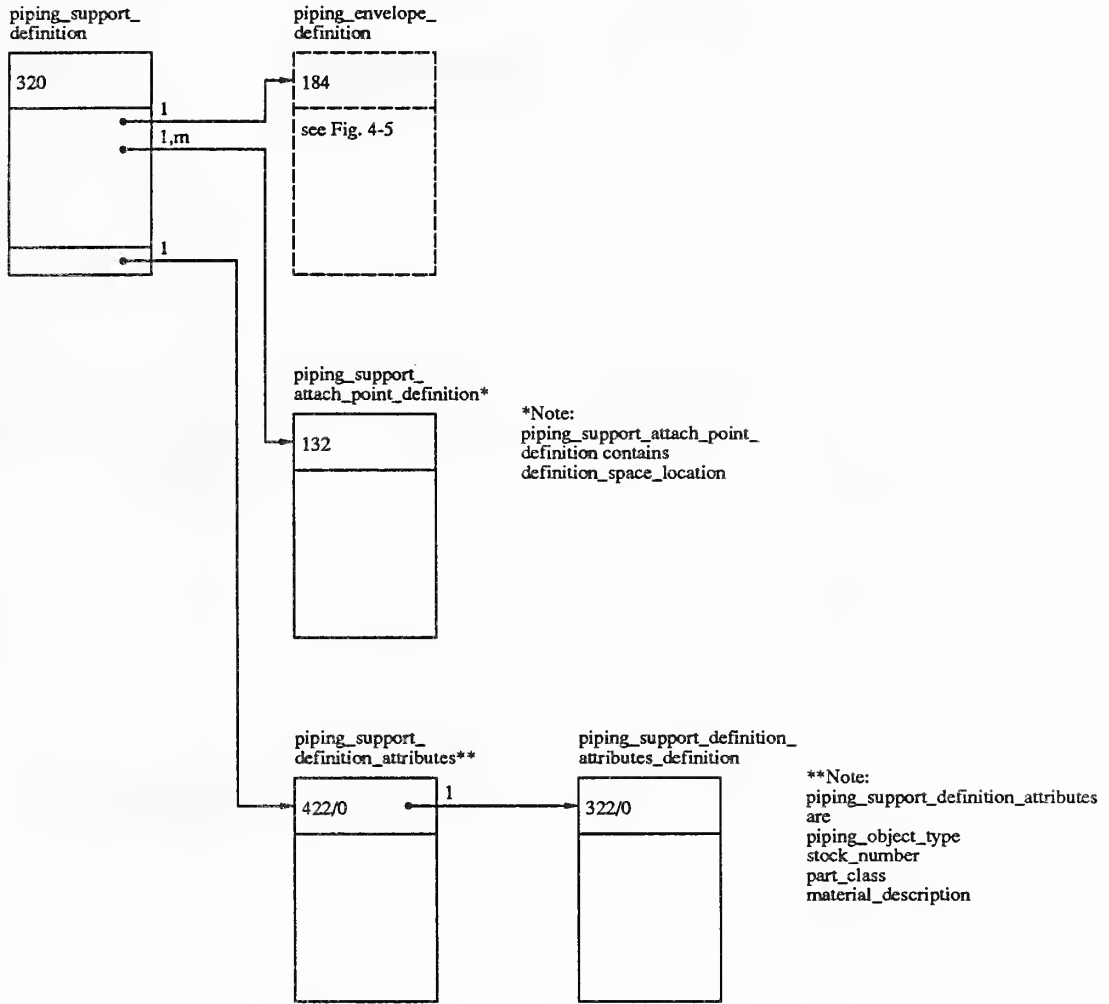

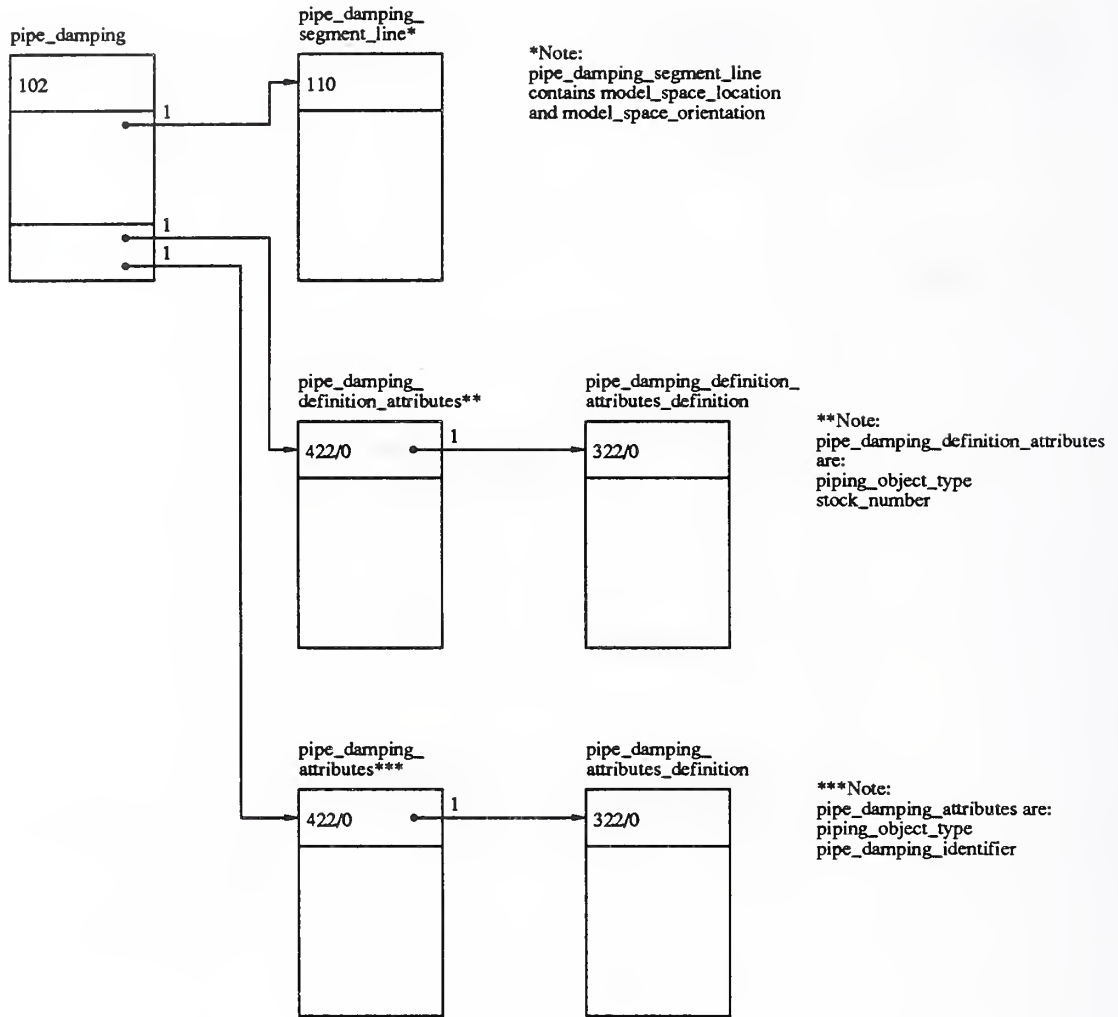

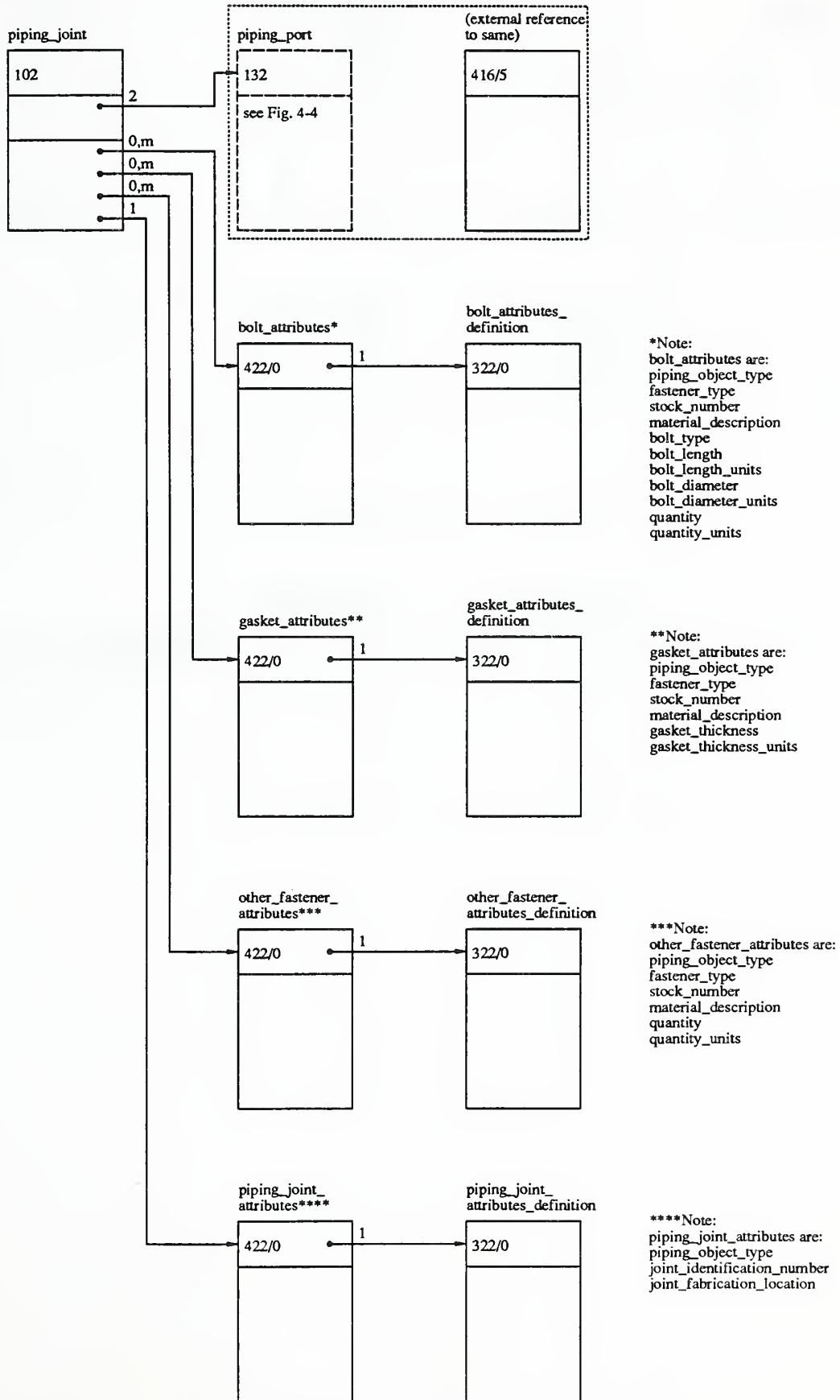

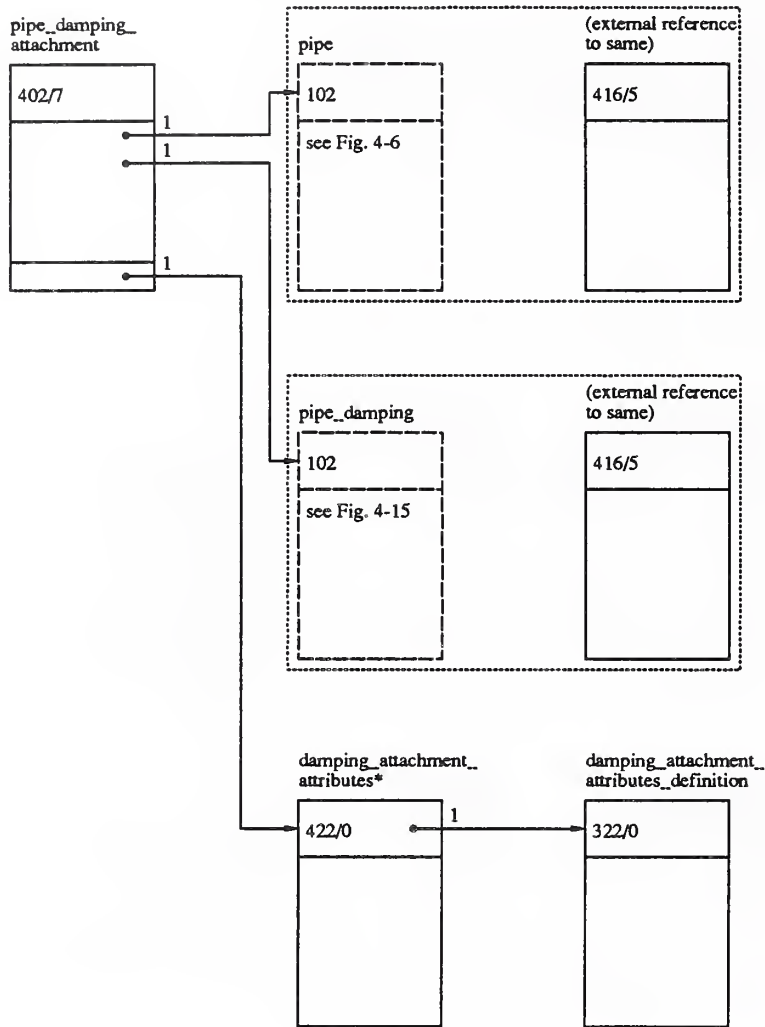

*Note:
damping_attachment_attributes are:
piping_object_type

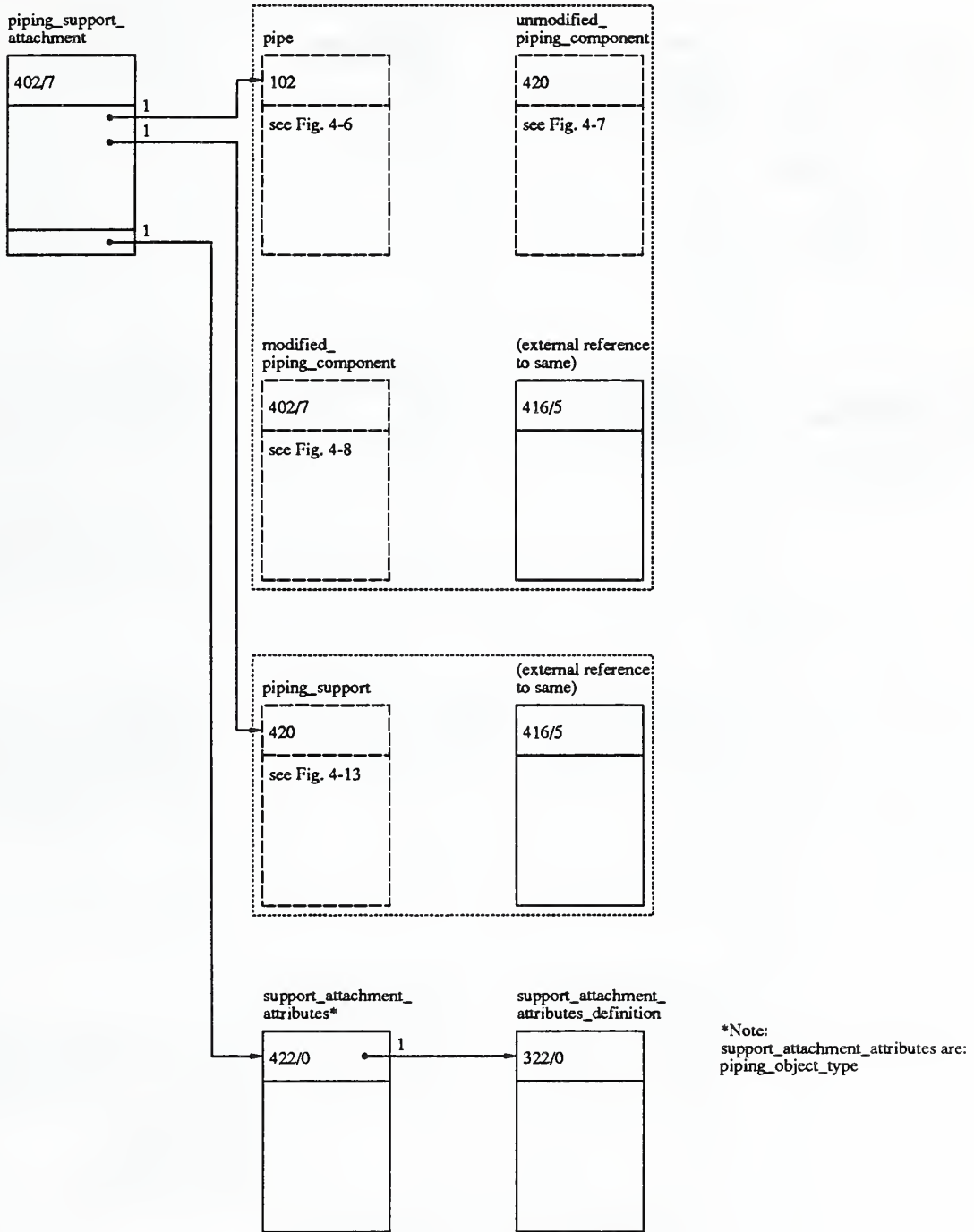

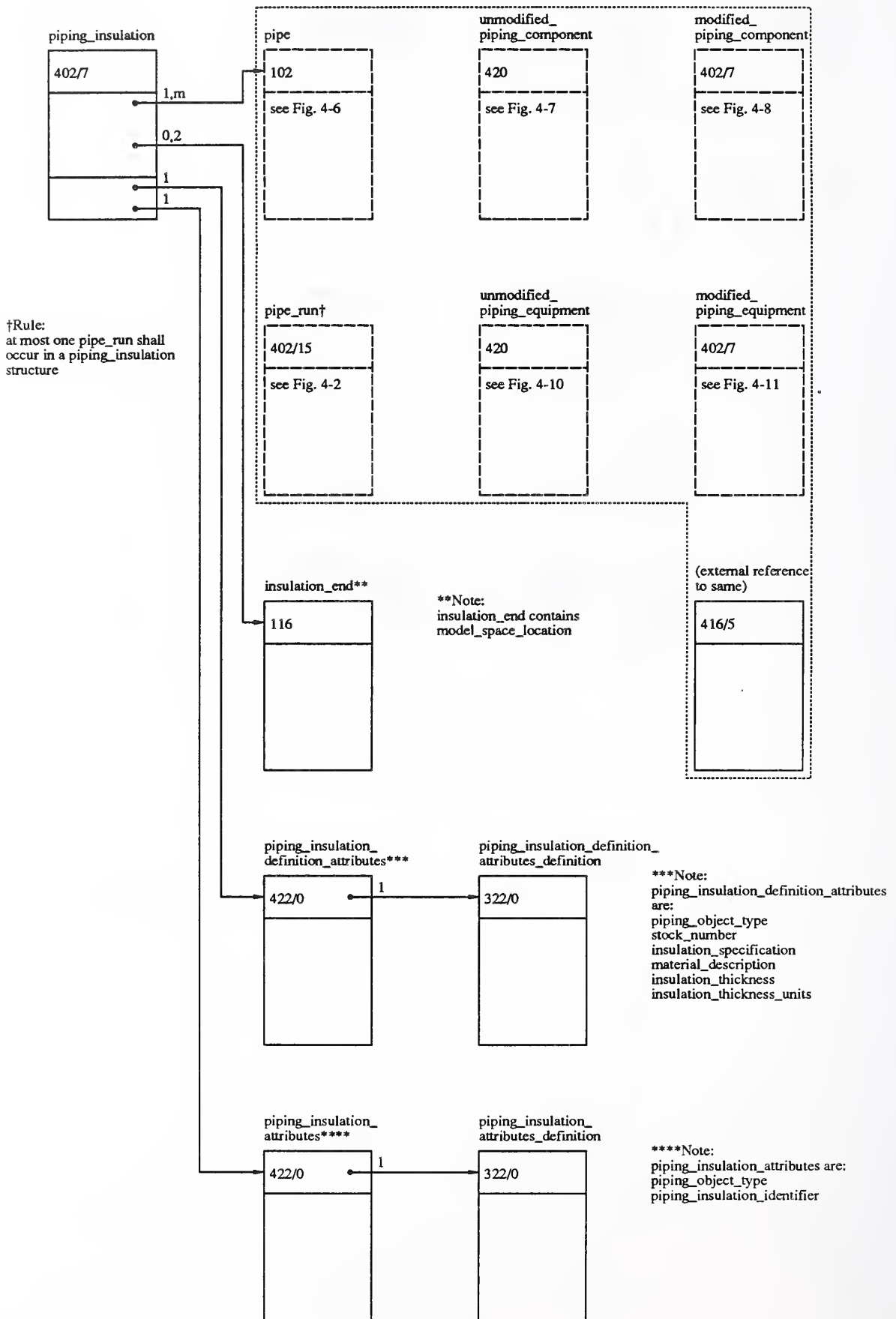

APPENDIX E. GUIDE TO READING IGES AIM DIAGRAMS

A solid box denotes an IGES Entity Type *ttt/Form fff* that begins an IGES construct representing the piping entity "piping_model_entity_name".

The top portion of the box denotes the entity's DE section. The middle portion denotes the entity's regular PD section. The bottom portion denotes the end of the PD section containing "additional pointers as required".

A dashed box denotes an IGES Entity Type *ttt/Form fff* that begins an IGES construct representing the piping entity "piping_model_entity_name" whose definition is to be found in Fig. 4-X.

A dotted outline bounds the choices where an IGES Entity may point to more than one IGES Entity Type.

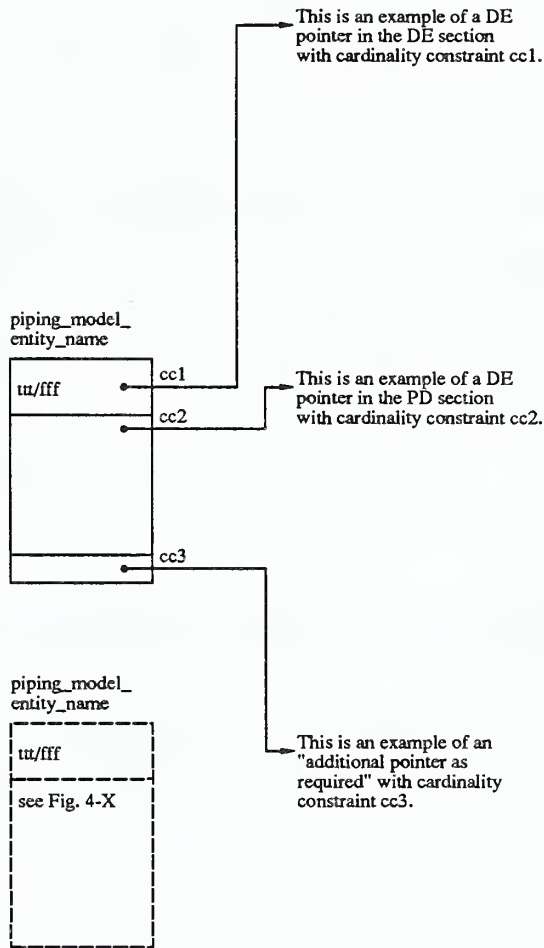

Examples of cardinality constraints are:

- 0,1: zero or one
- 1: one and only one
- 0,m: zero, one, or many
- 1,m: one or many

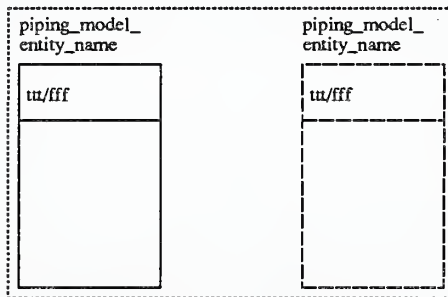



BIBLIOGRAPHIC DATA SHEET

4. TITLE AND SUBTITLE

3D Piping IGES Application Protocol, Version 1.0

5. AUTHOR(S)

Mark E. Palmer, Kent A. Reed

6. PERFORMING ORGANIZATION (IF JOINT OR OTHER THAN NIST, SEE INSTRUCTIONS)

U.S. DEPARTMENT OF COMMERCE
NATIONAL INSTITUTE OF STANDARDS AND TECHNOLOGY
GAITHERSBURG, MD 20899

7. CONTRACT/GRANT NUMBER

8. TYPE OF REPORT AND PERIOD COVERED

9. SPONSORING ORGANIZATION NAME AND COMPLETE ADDRESS (STREET, CITY, STATE, ZIP) Partial funding from:

Naval Sea Systems Command
Dept. of the Navy
Washington, DC 20362-5101

OASD P&L/S/CALS
Department of Defense
Washington, DC 20301-8000

10. SUPPLEMENTARY NOTES

11. ABSTRACT (A 200-WORD OR LESS FACTUAL SUMMARY OF MOST SIGNIFICANT INFORMATION. IF DOCUMENT INCLUDES A SIGNIFICANT BIBLIOGRAPHY OR LITERATURE SURVEY, MENTION IT HERE.)

The 3D Piping IGES Application Protocol (AP) specifies the mechanisms for defining and exchanging 3D piping system models in IGES format. The AP defines three-dimensional arrangement data of piping systems which includes definition data types of geometry (shape and location), connectivity, and material characteristics. The scope of this AP includes only piping system data and not drawings or internal details of equipment. The specified piping model is sufficiently detailed to support the fabrication and final assembly of a piping system.

IGES is designed to support a broad range of applications and information, and it is recognized that few implementations will support all of the specification. An application protocol defines a logical subschema of the IGES specification, the usage of the subschema, and the necessary benchmarks for testing implementations. The 3D Piping IGES Application Protocol is the first IGES AP to be delivered to industry and is an important example for the development of STEP (Standard for the Exchange of Product Model Data) application protocols.

12. KEY WORDS (6 TO 12 ENTRIES; ALPHABETICAL ORDER; CAPITALIZE ONLY PROPER NAMES; AND SEPARATE KEY WORDS BY SEMICOLONS)

application protocols; application validation; CAD data exchange; computer-aided design; data exchange standards; data translation quality assurance; data translators; IGES application protocols; information management; piping design; piping systems

13. AVAILABILITY

UNLIMITED
FOR OFFICIAL DISTRIBUTION. DO NOT RELEASE TO NATIONAL TECHNICAL INFORMATION SERVICE (NTIS).
 ORDER FROM SUPERINTENDENT OF DOCUMENTS, U.S. GOVERNMENT PRINTING OFFICE,
WASHINGTON, DC 20402.
 ORDER FROM NATIONAL TECHNICAL INFORMATION SERVICE (NTIS), SPRINGFIELD, VA 22161.

14. NUMBER OF PRINTED PAGES

257

15. PRICE

A]2

