

REFERENCE

NBS
Publi-
cations

NAT'L INST. OF STAND & TECH

A11106 031758

NBSIR 85-3026

ROUND ROBINS ON THE APPARENT THERMAL CONDUCTIVITY OF LOW- DENSITY GLASS FIBER INSULATIONS USING GUARDED HOT PLATE AND HEAT FLOW METER APPARATUS

J. G. Hust
C. M. Pelanne

National Bureau of Standards
U.S. Department of Commerce
Boulder, Colorado 80303

May 1985

QC
100
U56
85-3026
1985

NATIONAL BUREAU
OF STANDARDS
LIBRARY
Ref - NBS
QC
100
1456
No. 85-3026
1985

NBSIR 85-3026

ROUND ROBINS ON THE APPARENT THERMAL CONDUCTIVITY OF LOW- DENSITY GLASS FIBER INSULATIONS USING GUARDED HOT PLATE AND HEAT FLOW METER APPARATUS

J. G. Hust

Chemical Engineering Science Division
National Engineering Laboratory
National Bureau of Standards
U.S. Department of Commerce
Boulder, Colorado 80303

C. M. Pelanne

Consultant—Thermal Insulation
4900 Pinyon
Littleton, Colorado 80123

May 1985

Sponsored, in part, by:
Department of Energy/ORNL
American Society for Testing and Materials (ASTM)
Mineral Insulation Manufacturers Association (MIMA)



U.S. DEPARTMENT OF COMMERCE, Malcolm Baldrige, Secretary

NATIONAL BUREAU OF STANDARDS, Ernest Ambler, Director

CONTENTS

	<u>Page</u>
Abstract	
1. INTRODUCTION	2
2. SCOPE	3
3. OBJECTIVES	3
4. EXPERIMENTAL DATA	4
5. REFERENCE EQUATION	5
6. ROUND ROBIN I	33
6.1 Overview	33
6.2 Test Specimens	33
6.3 Test Equipment	34
6.4 Results	34
7. ROUND ROBIN II	51
7.1 Overview	51
7.2 Test Specimens	51
7.3 Test Equipment	52
7.4 Results	52
8. ROUND ROBIN III	71
8.1 Overview	71
8.2 Test Specimens	72
8.3 Test Equipment	73
8.4 Results	73
9. SUMMARY AND CONCLUSIONS	89
9.1 Separation of Variabilities	89
9.2 Round Robin I	91
9.3 Round Robin II	91
9.4 Round Robin III	91
9.5 General Summary	92
10. RECOMMENDATIONS	94
11. ACKNOWLEDGMENTS	95
12. REFERENCES	96
13. APPENDIX	A1

LIST OF FIGURES

	<u>Page</u>
Figure 5.1 Thermal Conductivity versus Density of NBS Data on Round Robin II and III (The lines show the approximate temperature of the data.)	11
Figure 5.2 Thermal Conductivity versus Temperature of NBS Data on Round Robin II and III	12
Figure 5.3 Thermal Conductivity versus Thickness of NBS Data on Round Robin II and III	13
Figure 5.4 Thermal Conductivity versus Density of NBS Data on Round Robin II. (The lines show the approximate temperature of the data.)	14
Figure 5.5 Thermal Conductivity versus Density of NBS Data on Round Robin III	15
Figure 5.6 Thermal Conductivity versus Temperature of NBS Data on Round Robin II	16
Figure 5.7 Thermal Conductivity versus Thickness of NBS Data on Round Robin III	17
Figure 5.8 Deviations between Thermal Conductivity Data of NBS on Round Robin II and III and Values Calculated from the Model versus Density	18
Figure 5.9 Deviations between Thermal Conductivity Data of NBS on Round Robin II and III and Values Calculated from the Model versus Temperature	19
Figure 5.10 Deviations between Thermal Conductivity Data of NBS on Round Robin II and III and Values Calculated from the Model versus Thickness	20
Figure 5.11 Deviations between Thermal Conductivity Data of NBS on Round Robin II and Values Calculated from the Model versus Density	21
Figure 5.12 Deviations between Thermal Conductivity Data of NBS on Round Robin III and Values Calculated from the Model versus Density	22
Figure 5.13 Deviations between Thermal Conductivity Data of NBS on Round Robin II and Values Calculated from the Model versus Temperature	23
Figure 5.14 Deviations between Thermal Conductivity Data of NBS on Round Robin III versus Thickness	24
Figure 5.15 Thermal Conductivity versus Density for Several Temperature as Calculated from the Model. Emittance = 0.95, Thickness = 2.54 cm, and Fiber Diameter = 5.0 μm	25

Figure 5.16	Thermal Conductivity versus Temperature for Several Densities as Calculated from the Model. Emittance = 0.95, Thickness = 2.54 cm, and Fiber Diameter = 5.0 μm	26
Figure 5.17	Thermal Conductivity versus Thickness for Several Densities as Calculated from the Model. Emittance = 0.95, Temperature = 300 K, and Fiber Diameter = 5.0 μm	27
Figure 5.18	Thermal Conductivity versus Emittance for Several Thicknesses as Calculated from the Model. Temperature = 300 K, Density = 10 kg/m^3 , and Fiber Diameter = 5.0 μm	28
Figure 5.19	Thermal Conductivity versus Fiber Diameter as Calculated from the Model. Emittance = 0.95, Temperature = 300 K, Density = 10 kg/m^3 , and Thickness = 2.54 cm	29
Figure 5.20	Thermal Conductivity versus Thickness for Several Emittances as Calculated from the Model. Temperature = 300 K, Density = 10 kg/m^3 , and Fiber Diameter = 5.0 μm	30
Figure 5.21	Thermal Conductivity Components (air, solid, radiation and total) versus Density as Calculated from the Model. Emittance = 0.95, Temperature = 300 K, Thickness = 2.54 cm, and Fiber Diameter = 5.0 μm	31
Figure 5.22	Thermal Conductivity Components (air, solid, radiation, and total) versus Temperature as calculated from the Model. Emittance = 0.95, Density = 10 kg/m^3 , Thickness = 2.54 cm, and Fiber Diameter = 5.0 μm	32
Figure 6.1	Thermal Conductivity versus Density for the 915-406 mm and 915-305 mm Heat Flow Meter Apparatus from Round Robin I	40
Figure 6.2	Thermal Conductivity versus Density for the 610-254 mm Heat Flow Meter Apparatus from Round Robin I	41
Figure 6.3	Thermal Conductivity versus Density for the Guarded Hot Plate Apparatus from Round Robin I	42
Figure 6.4	Thermal Conductivity versus Density for all of the Data from Round Robin I	43
Figure 6.5	Deviations between Thermal Conductivity Data for the 915-406 mm and 915-305 mm Heat Flow Meter Apparatus from Round Robin I and Values Calculated from the Model versus Density	44
Figure 6.6	Deviations between Thermal Conductivity Data for the 610-254 mm Heat Flow Meter Apparatus from Round Robin I and Values Calculated from the Model versus Density	45
Figure 6.7	Deviations between Thermal Conductivity Data from the Guarded Hot Plate Apparatus from Round Robin I and Values Calculated from the Model versus Density	46

Figure 6.8	Deviations between all Thermal Conductivity Data from Round Robin I and Values Calculated from the Model versus Density	47
Figure 6.9	Thermal Conductivity versus Density for Control Data taken by Lab 17 for Round Robin I over the period 1976 to 1980	48
Figure 6.10	Deviations between Control Data from Lab 17 and Values Calculated from the Model versus Density	49
Figure 6.11	Deviations between Control Data from Lab 17 for Round Robin I and Values Calculated from the Model versus Time	50
Figure 7.1	Thermal Conductivity versus Density for Heat Flow Meter Apparatus from Round Robin II	59
Figure 7.2	Thermal Conductivity versus Density for Guarded Hot Plate Apparatus from Round Robin II	60
Figure 7.3	Thermal Conductivity versus Density for all Primary Round Robin II Data	61
Figure 7.4	Thermal Conductivity versus Density for Supplementary Round Robin II Data	62
Figure 7.5	Deviations between Thermal Conductivity Data for Heat Flow Meter Apparatus from Round Robin II and Values Calculated from the Model versus Density	63
Figure 7.6	Deviations between Thermal Conductivity Data for Guarded Hot Plate Apparatus from Round Robin II and Values Calculated from the Model versus Density	64
Figure 7.7	Deviations between all Primary Thermal Conductivity Data from Round Robin II and Values Calculated from the Model versus Density	65
Figure 7.8	Deviations between Supplementary Thermal Conductivity Data from Round Robin II and Values Calculated from the Model versus Density	66
Figure 7.9	Thermal Conductivity versus Density of Control Data taken by Lab 17 for Round Robin II over the Period 1974 to 1983.	67
Figure 7.10	Deviations between Control Data from Lab 17 for Round Robin II and Values Calculated from the Model versus Density	68
Figure 7.11	Deviations between Control Data from Lab 17 for Round Robin II and Values Calculated from the Model versus Time (Set 1)	69

Figure 7.12	Deviations between Control Data from Lab 17 for Round Robin II and Values Calculated from the Model versus Time (Set 2)	70
Figure 8.1	Thermal Conductivity versus Density of all Round Robin III Data	78
Figure 8.2	Thermal Conductivity versus Thickness of all Round Robin III Data	79
Figure 8.3	Deviations between all Thermal Conductivity Data From Round Robin III and Values Calculated from the Model versus Density	80
Figure 8.4	Deviations between All Thermal Conductivity Data from Round Robin III and Values Calculated from the Model versus Thickness	81
Figure 8.5	Deviations between the Thermal Conductivity Data from Round Robin III at a Thickness of 25.4 mm and Values Calculated from the Model versus Density	82
Figure 8.6	Deviations between the Thermal Conductivity Data from Round Robin III at a Thickness of 50.8 mm and values Calculated from the Model versus Density	83
Figure 8.7	Deviations between the Thermal Conductivity Data from Round Robin III at a Thickness of 76.2 mm and values Calculated from the Model versus Density	84
Figure 8.8	Deviations between the Thermal Conductivity Data from Round Robin III at a Thickness of 101.6 mm and values Calculated from the Model versus Density	85
Figure 8.9	Deviations between the Thermal Conductivity Data from Round Robin III at a Nominal Density of 11 kg/m ³ and Values Calculated from the Model versus Thickness	86
Figure 8.10	Deviations between the Thermal Conductivity Data from Round Robin III at a Nominal Density of 16 kg/m ³ and Values Calculated from the Model versus Thickness	87
Figure 8.11	Deviations between the Thermal Conductivity Data from Round Robin III at a Nominal Density of 19 kg/m ³ and Values Calculated from the Model versus Thickness	88
Figure 13.1	Description of Samples for Round Robin	A2
Figure 13.2	Standardized Reference Values for the Round Robin II Samples	A3

LIST OF TABLES

	<u>Page</u>
Table 5.1 ASTM C-16.30/MIMA Round Robins. National Bureau of Standards Test Results. Reference Base for Calibrated Specimens used for Round Robin II	9
Table 5.2 ASTM C-16.30/MIMA Round Robins. National Bureau of Standards Data for Round Robin III	10
Table 6.1 ASTM C-16.30/MIMA Round Robins. Data from the 915-406 mm and 915-305 mm Heat Flow Meter Apparatus for Round Robin I.	36
Table 6.2 ASTM C-16.30/MIMA Round Robins. Data from 610-254 mm Heat Flow Meter Apparatus for Round Robin I	37
Table 6.3 ASTM C-16.30/MIMA Round Robins. Data from the Guarded Hot Plate Apparatus for Round Robin I	38
Table 6.4 ASTM C-16.30/MIMA Round Robins. Data from Lab 17 over the Time Period from 1976 to 1980 for Round Robin I	39
Table 7.1 ASTM C-16.30/MIMA Round Robins. Data from Heat Flow Meter Apparatus for Round Robin II	54
Table 7.2 ASTM C-16.30/MIMA Round Robins. Data from Guarded Hot Plate Apparatus for Round Robin II	55
Table 7.3 ASTM C-16.30/MIMA Round Robins. Data from Lab 17 over the Time Period from 1974 to 1983 for Round Robin II (610-254 mm plates)	56
Table 7.4 ASTM C-16.30/MIMA Round Robins. Data from Lab 17 over the Time Period from 1974 to 1983 for Round Robin II (305-152 mm plates)	57
Table 7.5 ASTM C-16.30/MIMA Round Robins. Special Tests with Thickness and Temperature as Variables (with and without septum)	58
Table 8.1 ASTM C-16.30/MIMA Round Robins. Primary Data for Round Robin III	75
Table 8.2 ASTM C-16.30/MIMA Round Robins. Secondary Data for Round Robin III	76
Table 8.3 ASTM C-16.30/MIMA Round Robins. Tests Performed at Lab 17 on Individual Stacked Sets of Specimens from Round Robin III using Heat Meter Apparatus	77
Table 9.1 Average Deviations and 2s Values For Selected Subsets and Data For Each of the Round Robins	90
Table 13.1 ASTM C-16.30/MIMA Round Robins. Participants and Reviewers	A4
Table 13.2 ASTM C-16.30/MIMA Round Robins. Coding Methodology	A5

Table 13.3	Typical Data Form used for Reporting Test Results	A7
Table 13.4	Specimen Sizes, Weights, and Densities for Round Robin I .	A8
Table 13.5	Specimen Sizes, Weights, and Densities for Round Robin II.	A9
Table 13.6	Specimen Sizes, Weights, and Densities for Round Robin III	A10
Table 13.5.1	ASTM C-16.30/MIMA Round Robins. National Bureau of Standards Test Results. Reference Base for Calibrated Specimens used for Round Robin II	A11
Table 13.5.2	ASTM C-16.30/MIMA Round Robins. National Bureau of Standards Data for Round Robin III	A12
Table 13.6.1	ASTM C-16.30/MIMA Round Robins. Data from the 915-406 mm and 915-305 mm Heat Flow Meter Apparatus for Round Robin I	A13
Table 13.6.2	ASTM C-16.30/MIMA Round Robins. Data from 610-254 mm Heat Flow Meter Apparatus for Round Robin I	A14
Table 13.6.3	ASTM C-16.30/MIMA Round Robins. Data from the Guarded Hot Plate Apparatus for Round Robin I.	A15
Table 13.6.4	ASTM C-16.30/MIMA Round Robins. Data from Lab 17 over the Time Period from 1976 to 1980 for Round Robin I . .	A16
Table 13.7.1	ASTM C-16.30/MIMA Round Robins. Data from Heat Flow Meter Apparatus for Round Robin II	A17
Table 13.7.2	ASTM C-16.30/MIMA Round Robins. Data from Guarded Hot Plate Apparatus for Round Robin II	A18
Table 13.7.3	ASTM C-16.30/MIMA Round Robins. Data from Lab 17 over the Time Period from 1974 to 1983 for Round Robin II (610-254 mm plates)	A19
Table 13.7.4	ASTM C-16.30/MIMA Round Robins. Data from Lab 17 over the Time Period from 1974 to 1983 for Round Robin II (305-152 mm plates)	A20
Table 13.7.5	ASTM C-16.30/MIMA Round Robins. Special Tests with Thick- ness and Temperature as Variables (with and without septum)	A21
Table 13.8.1	ASTM C-16.30/MIMA Round Robins. Primary Data for Round Robin III	A22
Table 13.8.2	ASTM C-16.30/MIMA Round Robins. Secondary Data for Round Robin III	A23
Table 13.8.3	ASTM C-16.30/MIMA Round Robins. Tests Performed at Lab 17 on Individual Stacked Sets of Specimens from Round Robin III using Heat Meter Apparatus	A24

Table of Nomenclature

Avg. Dev. = Average deviation of a subset of data from the model (observed minus model)

D = Specimen density

ϵ = Plate emittance

F = Fiber diameter in μm

GHP = Guarded hot plate

HFM = Heat flow meter

Interlaboratory reproducibility = Reproducibility between laboratories

Intralaboratory reproducibility = Reproducibility within laboratories

k_a , λ = Apparent thermal conductivity

L = Specimen thickness

λ_g = Gas component of thermal conductivity

λ_r = Radiation component of thermal conductivity

λ_s = Solid component of thermal conductivity

P_1 , P_2 , P_3 , P_4 , and P_5 = Parameters in model

PCT = $[k_a(\text{obs.}) - k_a(\text{calc.})] 100/k_a(\text{calc.})$

σ = Stefan-Boltzmann constant = $5.6703 \times 10^{-5} \text{ mW}\cdot\text{m}^{-2}\cdot\text{K}^{-4}$

Thickness effect = Dependency of thermal conductivity on specimen thickness

2s = two times the standard deviation of the test results with respect to their mean (an approximation of the 95% confidence interval)

Round Robins on the Apparent Thermal Conductivity of Low-Density Glass
Fiber Insulations Using Guarded Hot Plate and Heat Flow Meter Apparatus

By

J.G. Hust
National Bureau of Standards
Boulder, CO 80303

and

C.M. Pelanne
Consultant-Thermal Insulation
Littleton, CO 80123

This National Bureau of Standards report* presents the results and the data analysis pertaining to these results for three round robins on the thermal performance of guarded hot plates and heat flow meters when measuring the thermal resistance properties of low density glass fibrous thermal insulations. The three round robins were carried out under the sponsorship of the American Society for Testing and Materials (ASTM) Subcommittee C-16.30 on Thermal Measurements and the Mineral Insulation Manufacturers Association (MIMA).

The test results are compared to a reference equation and to each other to illustrate intralaboratory and interlaboratory reproducibility as well as the dependencies on temperature, density, plate emittance, specimen thickness, and fiber diameter.

The study shows that, with good laboratory practices, interlaboratory agreement of about 2% is obtained. Over 300 test results obtained by 12 different laboratories are reported. This report also discusses the magnitude of the specimen thickness effect and its dependence on plate emittance.

Key words: apparent thermal conductivity; guarded hot plate; heat flow meter; low density; Round Robins; thermal insulation; thickness effect.

*This work was funded, in part, by DOE/ORNL under contract number ORNL/IA-21428.

1. INTRODUCTION

During the last 10 to 15 years considerable progress has been made in the development and improvement of the equipment and techniques for the measurement of the thermal resistance of thermal insulations, particularly low density insulations. The worldwide interest in energy conservation has resulted in increased effort toward the production of improved and more cost effective commercial insulations, primarily aimed at the building industry, which uses the greatest amount of thermal insulation. The two apparatus generally used to measure the thermal resistance of these low density insulations are, the guarded hot plate (GHP), ASTM C177 [1]¹ and the heat flow meter (HFM), ASTM C518 [2].

The development of thermally effective low density thermal insulation has had a significant impact on the technical aspect of the measurement of thermal resistance. This, combined with a better understanding of the heat transfer principles involved in low density thermal insulations [3], has prompted the producers and the users to strive toward increased accuracy in the determination of the thermal resistance. This has been reflected by the active participation of the major manufacturers of insulation, commercial laboratories, and government agencies in the debates of the American Society for Testing and Materials (ASTM). A most active forum for these debates has been ASTM C-16.30 Subcommittee on Thermal Measurements whose scope states "Develop and maintain test methods and recommended practices relating to the transfer of energy with and through thermal insulating materials and systems" [4].

To assess the measurement capabilities in this field, a task force was established in 1976 under the sponsorship of the Mineral Insulation Manufacturers Association (MIMA)* and later co-sponsored by ASTM C-16.30 Subcommittee on Thermal Measurements, Spring 1977. The objective was to evaluate the measurement capabilities of the thermal insulation community when measuring building insulation at thicknesses beyond which reference standards were available (round robin I). Concurrently, round robin II was established to investigate the influence of plate emittance on the measurement of low density fibrous insulations. In October of 1979 round robin III was initiated to assist in the evaluation of the NBS line-source GHP [16] and to provide information on the measurement capabilities of the existing equipment when measuring increasing thicknesses of insulation. The results of these three round robins will be of value in establishing the required precision and bias statements for the test methods C177 and C518. The execution of these three round robins was under the responsibility of C.M. Pelanne, Chairman of Task Force 1.6 on Round Robins, ASTM C-16.30 Subcommittee on Thermal Measurements.

Past round robin studies of a similar nature have been reported [5], [6]. While they may be outdated by recent advances they should be noted for comparison. Several other round robins are currently underway. One sponsored by the International Standards Organization T. C. 163 is being carried out to evaluate the international capabilities of GHP's and HFM's, [7]. Another one sponsored by ASTM Subcommittee C-16.30 is to assess the performance of guarded and calibrated hot boxes, [8]. The reports on these two later round robins are expected in the near future.

*Tradenames are included in this report for clarity and completeness. The use of these tradenames does not imply endorsement of these organizations or their products by NBS.

¹Numbers in brackets indicate the literature references at the end of the paper.

Another significant event in the field of thermal insulation measurement is the establishment the National Voluntary Laboratory Accreditation Program (NVLAP) within NBS which is contributing to the improvement of interlaboratory reproducibility.

The measurement community has made a conscientious effort to produce reliable data. The participants have demonstrated their concern with accuracy and precision of measurement through continuous participation in technical and standards writing organizations throughout the world.

This report provides the analysis of the data from the three recently completed round robins. In addition to all of the pertinent data, other related details are provided for further analysis and study by interested parties.

2. SCOPE

This report presents the results and analysis of data obtained during the course of three round robins carried out over a period of about six years from September 1976 to April 1983. These three round robins, identified as Round Robins I (RR I), II (RR II), and III (RR III) were co-sponsored by ASTM Subcommittee C-16.30 on Thermal Measurement and the Mineral Insulation Manufacturers Association. Twelve testing laboratories representing the following organizations participated in part or all of these three round robins:

Certain-Teed Corporation, Blue Bell, PA
Dynatech R/D Company, Cambridge, MA
Institute for Research, Houston, TX
Jim Walter Research Corporation, St. Petersburg, FL
Manville Corporation, Denver, CO
National Bureau of Standards, Gaithersburg, MD
National Research Council of Canada, Ottawa, Canada
Owens-Corning Fiberglas Corporation, Granville, OH
Rockwool Industries Inc., Belton, TX

The individual participants and reviewers are listed in Table 13.1 of the Appendix. To facilitate the study of this report it is divided into the following sections:

Reference Equation
Round Robin I
Round Robin II
Round Robin III

3. OBJECTIVES

The objectives of the three round robins covered by this report were as follows:

Round Robin I-- To evaluate the thermal measurement capabilities of the thermal insulation community when measuring building insulations at thicknesses beyond which reference standards were available at the time. The tests were performed from September 1976 to June 1980.

Round Robin II-- To evaluate the thermal insulation testing community's capability when measuring low density thermal insulations, where the effect of apparatus surface plate emittance can have an influence on the results due to radiative heat transfer. The tests were performed from February 1977 to May 1979.

Round Robin III-- To provide information to the National Bureau of Standards for the evaluation of the new line-source guarded hot plate. In addition, to provide information on the measurement capabilities of existing large guarded hot plates for measuring thick insulation when the "effect of thickness" may play a part on the results. The tests were performed January 1980 to April 1983.

In each of the round robins all of the participating laboratories tested the same specimens. However, it should be noted that the measuring plates were not all the same size and, therefore, different portions of the specimens were tested. Further details on the plate sizes and specimen characterization are provided in the following sections and the appendix.

4. EXPERIMENTAL DATA

The experimental data were compiled into tabular files for analysis by computer. They were reported by the participants on standardized forms (see appendix). The tabular listings are given in the individual sections. The data in the main body of the report are given in SI units. The original data in Btu units are given in the appendix. The coding methodology of these data tables is also given in the appendix.

Upon completion of the tests by the participants the specimens were cut into sizes corresponding to the test area of each apparatus. The weights and dimensions of the individual pieces were determined in order to calculate the actual test area densities that were used in the analysis. These weights and densities are given in the appendix.

The data are not readily illustrated in graphical form because of the number of variables present in the tables, sometimes over very restricted ranges. For this reason, the dependencies of the data will be conveyed via a reference equation that has been developed to be consistent with the data. Deviations of the data from this equation are graphically presented to illustrate the consistency among the data. The deviation graphs are convenient to determine the interlaboratory and intralaboratory reproducibility. The table below provides the nominal ranges of thickness, temperature, density, fiber diameter, and thermal conductivity for each of the round robins.

Round Robin	Thickness (cm)	Mean Temperature (K)	Density (kg/m ³)	Fiber Diameter (μm)	Apparent Thermal Conductivity (mW·m ⁻¹ ·K ⁻¹)
I	8.9	297	12.3 - 14.6	5.27	39.5 - 43.4
II	2.5	288 - 332	10.6 - 33.5	5.53	29.6 - 56.0
III	2.5 - 10.2	297	11.3 - 19.8	5.00	37.4 - 45.6

For this analysis the fiber diameter of the RR I material was not measured but was arbitrarily chosen to be the average of the fiber diameters of

RR II and RR III. During the review process the supplier of RR I material indicated that the fiber diameter is more likely about 7 μm . If this value is used in the comparisons of section 6, the systematic deviations of the data from the reference equation will be larger than shown. This is relatively unimportant because the main objective of this report is to intercompare test results. The equation is simply a convenient mechanism to accomplish these intercomparisons. The relatively large fiber diameter and concomitant large systematic deviation does indicate, however, the significance of structure parameters other than fiber diameter.

5. REFERENCE EQUATION

An optimized reference equation was developed to establish a base of reference for purposes of comparison of the data. The optimization of the parameters in this equation was based on the data from the National Bureau of Standards because it covered the widest range of conditions. The two sets of NBS GHP data (from RR II and RR III) covered the complete range of variables involved, (type of material, density, thickness, and temperature).

As stated earlier this equation was developed primarily as a convenient tool for the intercomparison of the round robin test results. However, the reference equation has been optimized with respect to a data set that is comprehensive and consequently may prove to be useful for future comparisons. The data set on which the equation is based is comprehensive in that it covers several materials; a range of temperature, density, and thickness; and is determined by a national reference laboratory (NBS). It should be noted that no data from RR I was used to optimize the parameters of the equation because the RR I NBS data was obtained with a HFM instead of a GHP.

The selected data are as follows:

1. The specimens used for RR II were supplied by the Manville Research and Development Center, Denver, Colorado. Material from the same lot was measured by the National Bureau of Standards using the 20 cm (8 in) GHP. The data reported by NBS for these measurements covered a 11 to 32 kg/m^3 (0.7 to 2.0 lb/ft^3) density range, and a -18°C to 54°C (0°F to 130°F) temperature range. These data are given in Table 5.1. More extensive description of this material can be found in the literature [9].

2. The specimens used for RR III were provided by the National Bureau of Standards from a lot of material which is similar to one being considered for the development of low density reference material, [10,11]. The material was fabricated especially for the National Bureau of Standards by the Manville Corporation. This material has similar characteristics to those of the material used for RR II. Furthermore, these series of tests, as part of RR III, were carried out most extensively by NBS using the 1000 mm line-source GHP. The specimens were all measured as 25.4 mm (1.0 in) pairs as well as at increasing thicknesses as required by the round robin. While these tests provided data at only one temperature 24°C (75°F) they provided test data over a range of densities 11.2 to 19.2 kg/m^3 (0.7 to 1.2 lb/ft^3) and over a range of thicknesses 25.4 to 101.6 mm (1.0 to 4.0 inches). The data are shown in Table 5.2. Further explanation of the data in Tables 5.1 and 5.2 is given in the appendix. The data originally presented in Btu units are tabulated in the appendix.

The reference equation (referred to as the model for convenience) developed for this work is based on the common assumption that the apparent thermal conductivity, λ , of an insulation is the sum of three components, as indicated in eq (1). This equation is based on the assumption that the components are acting in parallel and independently, i.e. uncoupled.

These components are the interstitial gas conductivity, λ_g , (here the gas is air), the solid conductivity, λ_s , (glass fiber plus phenolic binder), and the radiation conductivity, λ_r .

$$\lambda = \lambda_g + \lambda_s + \lambda_r \quad (1)$$

The mathematical form and justification of each of these components is given below.

$$\lambda_g = P_3 [10^{-3} (148.503 + 94.5425T - 0.0263568T^2) + P_5 (T/296 - 1)] (2500 - D)/2500 \quad (2)$$

where T is temperature in K, D is density in kg/m³, and P₃ and P₅ parameters to be optimized.

The first three terms in eq (2) are a representation of the free-air thermal conductivity as obtained at NBS by L.J. Van Poolen (private communication). The P₅ term is a small adjustment to the temperature slope of the free-air conductivity to optimize the fit of these round robin data. The density term in eq (2) accounts for the volume fraction occupied by the glass fibers. Finally the parameter P₃ is essentially the gas form factor adjustment accounting for the distribution and structure of the glass fibers within the gas.

$$\lambda_s = P_1 D (T/296)/2500 \quad (3)$$

where P₁ is a parameter to be optimized.

Equation 3 is an approximation of the solid component (glass fiber) of thermal conductivity. The conductivity of bulk glass is known to depend on temperature with a power between 0.5 and 1.0. Since this term is a very small component of the total only a rough approximation is required. Thus, for simplicity, the power was chosen to be 1.0. The density dependence chosen indicates that the term increases linearly with increasing fiber content. The parameter, P₁, is dependent on the bulk glass conductivity and the tortuosity factor of the fibers and the phenolic binder.

$$\lambda_r = P_4 \sigma 4 T^3 / (P_2 D/F^{0.5} + (2/\epsilon - 1)/L) \quad (4)$$

where $\sigma = 5.6703 \cdot 10^{-5} \text{ mW} \cdot \text{m}^{-2} \cdot \text{K}^{-4}$, F = fiber diameter in μm , L is the specimen thickness in meters, and ϵ = emittance of the plates.

Equation 4 is the radiation component as given by the Stefan-Boltzmann radiation law for small temperature differences. The first term in the denominator accounts for the fiber density between the measuring plates and, in addition, the effect of fiber diameter on the radiation conductivity. The form of the fiber diameter dependence was based on unpublished data [18]. The second

term in the denominator accounts for plate emittance and plate spacing. It is noted that the specific correlation of fiber diameter with thermal conductivity will depend in part on pack structure and fiber diameter distribution. Thus, the values obtained for a given product may not be applicable to other products.

As explained earlier, the two sets of NBS data were chosen to optimize the parameters in the model. The first set of NBS data was obtained on specimens taken from the same lot as RR II. The second set of NBS data was obtained on the RR III specimens. These two sets of data are plotted as a function of density in figure 5.1, as a function of temperature in figure 5.2, and as a function of thickness in figure 5.3. To distinguish the data between sets 1 and 2, the data from set 1 are separately plotted as a function of density in figure 5.4 and as a function of temperature in figure 5.6. The data from set 2 are plotted as a function of density in figure 5.5 and as a function of thickness in figure 5.7. For convenience to the reader, in figures 5.1 and 5.4 solid lines have been superimposed to identify the approximate temperatures at which the data were obtained.

Nonlinear least squares techniques were used to optimize the parameters of the model. The optimized values of the parameters are given below:

$$\begin{array}{lll} P_1 = 71.87 & P_3 = 1.074 & P_5 = 4.0 \\ P_2 = 144.5 & P_4 = 2.0 & \end{array}$$

The deviations of the NBS experimental data from the model are displayed in figures 5.8 through 5.14 in the same sequence as figures 5.1 through 5.7. In each of these and subsequent deviation plots the average deviation of the data from the model and the 2s value are shown. The percentage deviations (observed minus calculated) are also listed in the last column of tables 5.1 and 5.2. Within the imprecision of the data no systematic trends in the deviations are obvious either as a function of density or temperature. Typical dependencies of the model are illustrated in figures 5.15 through 5.22.

Figure 5.15 illustrates the dependency of thermal conductivity on density from 10 to 40 kg/m³ at 250, 300, and 350 K and for a plate emittance of 0.95, a thickness of 2.54 cm and a fiber diameter of 5.0 μm. The increase in thermal conductivity at decreasing densities is caused by the increase in the radiation component. The expected minimum in the curves caused by decreasing radiation component and increasing solid component with increasing density occurs above 40 kg/m³.

Figure 5.16 illustrates the dependency of thermal conductivity on temperature from 250 to 350 K at densities of 10, 20, 30, and 40 kg/m³ and for an emittance of 0.95, a thickness of 2.54 cm, and a fiber diameter of 5.0 μm. At high densities the dependency is nearly linear because the conductance is caused by the gas and solid components. At low density the cubic dependency of the radiation term is more dominant.

Figure 5.17 illustrates the dependency of thermal conductivity on specimen thickness from 2 to 16 cm for densities of 10, 12, 14 kg/m³ at a temperature of 300 K, an emittance of 0.95, and a fiber diameter of 5.0 μm. The

thickness effect from 2 to 16 cm is 2.7, 2.1, and 1.6% at densities of 10, 12, and 14 kg/m³, respectively. One, of course, expects the thickness effect to decrease with increasing density due to the decreasing radiation component.

Figure 5.18 shows the dependency of thermal conductivity on plate emittance from 0.5 to 1 for thicknesses of 2, 4, 8, and 16 cm at a density of 10 kg/m³, temperature of 300 K, and fiber diameter of 5.0 μm. Plate emittances were not reported for the experimental data and are assumed to be 0.95, consistent with the C177 specification. Consequently, the dependency of the model on emittance is an inherent characteristic of the design of the model rather than an indication of the behavior of the data. It is possible that the actual emittances of the various plates may range from 0.75 to 0.95. This model would thus predict a possible variation of 1.6% in the measured conductivities at a thickness of 2 cm. Less variation would be predicted at greater thicknesses, larger densities, and lower temperatures. This potential variation is a strong argument for requiring the documentation of the emittance for any measurement in which the radiation component is significant.

Figure 5.19 depicts the dependency of thermal conductivity on fiber diameter from 5.0 to 6.0 μm at 300 K, 2.54 cm thickness, a density of 10 kg/m³, and an emittance of 0.95. Again the depicted dependency is more an inherent characteristic of the model rather than the behavior of experimental data because fiber diameter is not well known for these insulations. In any event, the model predicts a 4.6% increase in conductivity over this range of fiber diameter.

Figure 5.20 illustrates the thermal conductivity dependency on thickness from 2 to 16 cm at emittances of 0.8, 0.9, and 1.0, at a temperature of 300 K, density of 10 kg/m³, and a fiber diameter of 5.0 μm. The variation caused by this range of emittances at 16 cm thickness is only 0.2% while at 2 cm it is 1.4%. This model also shows an increased thickness effect at lower plate emittance. It should be noted, however, that this is not based on experimental data, since the plate emittances were not reported in this study.

Figure 5.21 is a comparison of the magnitudes of the three components in the model as a function of density from 10 to 40 kg/m³ at 300 K, 2.54 cm thickness, 0.95 emittance, and 5.0 μm fiber diameter. A logarithmic axis was chosen here for thermal conductivity so that the three components could be more accurately compared. It should be noted that the solid component is only about 1% of the total at 10 kg/m³ and about 2.5% at 40 kg/m³. The radiation component is about 40% of the total at 10 kg/m³ and 14% at 40 kg/m³.

Figure 5.22 also compares the magnitudes of the three components but as a function of temperature from 250 to 350 K at 2.54 cm thickness, 0.95 emittance and 5.0 μm fiber diameter and a density of 10 kg/m³. It is noted that the radiative component becomes relatively larger with increasing temperature while the gas and solid components become relatively smaller. This is expected because the power dependence of the radiative term is cubic in temperature while the gas and solid terms are nearly linear in temperature.

Table 5.1 ASTM C-16.30/MIMA Round Robins. National Bureau of Standards Test Results.
Reference Base for Calibrated Specimens used for Round Robin II.

RR NO.	LAB NO.	DATE M Y	EQUIP TYPE	TEST COND.	SPEC. NO.	THICK. cm	DENS. kg/m ³	HOT TEMP	COLD TEMP	MEAN TEMP	k mw/(m ² ·K)	FOOT-NOTES	PCT
II	13	0574	G0804	206	1	2.54	10.89	266.9	245.4	256.2	34.0	p	-1.6
II	13	0574	G0804	206	1	2.54	10.89	309.5	284.9	297.2	44.4	p	-0.7
II	13	0574	G0804	206	1	2.54	10.89	339.9	314.9	327.2	53.7	p	0.7
II	13	0574	G0804	206	2	2.54	11.37	309.5	284.9	297.2	44.7	p	1.4
II	13	0574	G0804	211	1	2.54	17.78	309.4	285.0	297.2	38.7	p	0.0
II	13	0574	G0804	211	2	2.54	17.14	309.4	284.9	297.2	38.8	p	-0.5
II	13	0574	G0804	216	1	2.54	25.15	267.0	245.3	256.2	29.1	p	0.6
II	13	0574	G0804	216	1	2.54	25.15	309.6	284.9	297.3	35.8	p	-0.1
II	13	0574	G0804	216	1	2.54	25.15	338.5	315.7	327.1	41.5	p	0.6
II	13	0574	G0804	216	2	2.54	26.43	309.4	284.9	297.2	35.0	p	-1.2
II	13	0574	G0804	221	1	2.54	33.16	309.4	285.0	297.2	33.9	p	-0.8
II	13	0574	G0804	221	2	2.54	34.44	309.4	284.9	297.2	33.9	p	-0.2

p: Specimens tested in pairs. Given values are the average.

Table 5.2. ASTM C-16.30/MIMA Round Robins. National Bureau of Standards Data for Round Robin III.

RR NO.	LAB NO.	DATE M Y	EQUIP TYPE	TEST COND.	SPEC. NO.	THICK. cm	DENS. kg/m ³	HOT TEMP	COLD TEMP	MEAN TEMP	k mW/(ft ² ·K)	FOOT-NOTES	PCT
III 13		0882	G4016	507	1	2.54	11.79	310.9	283.2	297.0	43.3	1s	1.1
III 13		0882	G4016	607	12	5.08	11.48	311.0	283.2	297.1	43.7	1s	0.2
III 13		0882	G4016	707	123	7.62	11.50	310.9	283.2	297.0	43.7	1s	-0.1
III 13		0882	G4016	807	1234	10.16	11.40	310.9	283.2	297.0	43.8	1s	-0.2
III 13		0882	G4016	509	1	2.54	15.51	310.9	283.2	297.0	39.4	1s	-0.3
III 13		0882	G4016	609	12	5.08	15.63	310.9	283.2	297.1	39.8	1s	0.4
III 13		0882	G4016	709	123	7.62	15.68	310.9	283.1	297.0	39.8	1s	0.3
III 13		0882	G4016	809	1234	10.16	15.60	310.9	283.1	297.0	39.8	1s	0.1
III 13		0882	G4016	512	1	2.54	19.30	310.9	283.0	297.0	37.5	1s	0.3
III 13		0882	G4016	612	12	5.08	19.00	310.9	283.2	297.0	37.8	1s	0.3
III 13		0882	G4016	712	123	7.62	19.38	310.9	283.2	297.0	37.6	1s	0.2
III 13		0882	G4016	812	1234	10.16	19.32	310.9	283.1	297.0	37.8	1s	0.5
III 13		0882	G4016	507	2	2.54	11.18	310.9	283.2	297.0	43.3	1s i	-0.7
III 13		0882	G4016	507	3	2.54	11.52	310.9	283.2	297.0	42.5	1s i	-1.4
III 13		0882	G4016	507	4	2.54	11.13	310.9	283.2	297.0	43.3	1s i	-0.8
III 13		0882	G4016	807	1234	10.16	11.40	310.9	283.2	297.0	43.8	1s i	-0.2
III 13		0882	G4016	807	1234	10.16	11.40	310.9	283.2	297.0	43.8	1s i	-0.2
III 13		0882	G4016	509	2	2.54	15.76	310.9	283.2	297.0	39.5	1s i	0.5
III 13		0882	G4016	509	3	2.54	15.79	310.9	283.2	297.0	39.1	1s i	-0.5
III 13		0882	G4016	509	4	2.54	15.33	310.9	283.2	297.0	40.0	1s i	0.9
III 13		0882	G4016	512	2	2.54	18.69	310.9	283.2	297.0	38.1	1s i	1.1
III 13		0882	G4016	512	3	2.54	20.13	310.9	283.2	297.0	37.1	1s i	0.1
III 13		0882	G4016	512	4	2.54	19.16	310.9	283.2	297.0	37.6	1s i	0.5

1s: Line source guarded hot plate-circular

i: Temperature not given, assumed on basis of others.

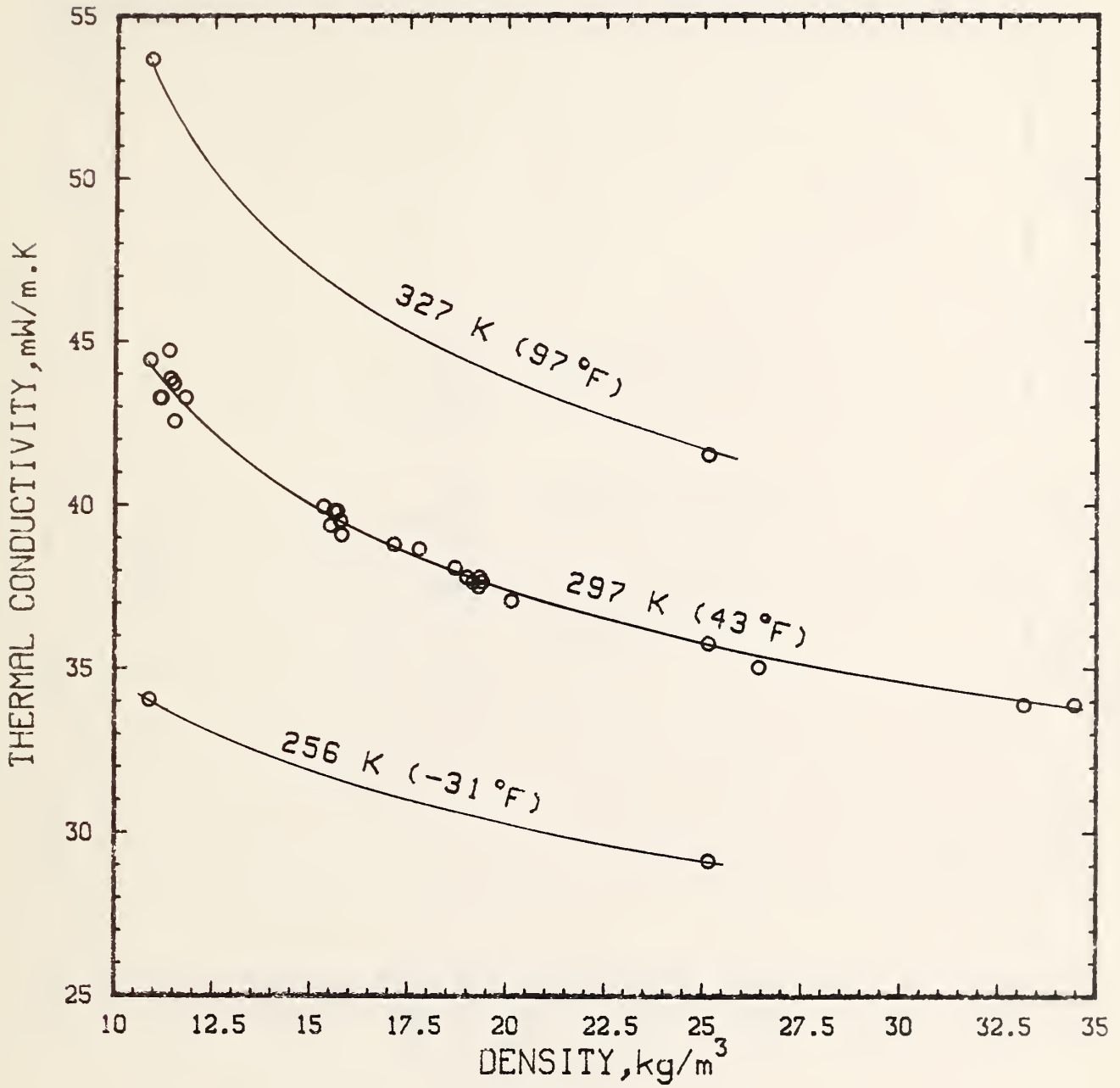

Figure 5.1 Thermal Conductivity versus Density of NBS Data on Round Robin II and III (The lines show the approximate temperature of the data.)

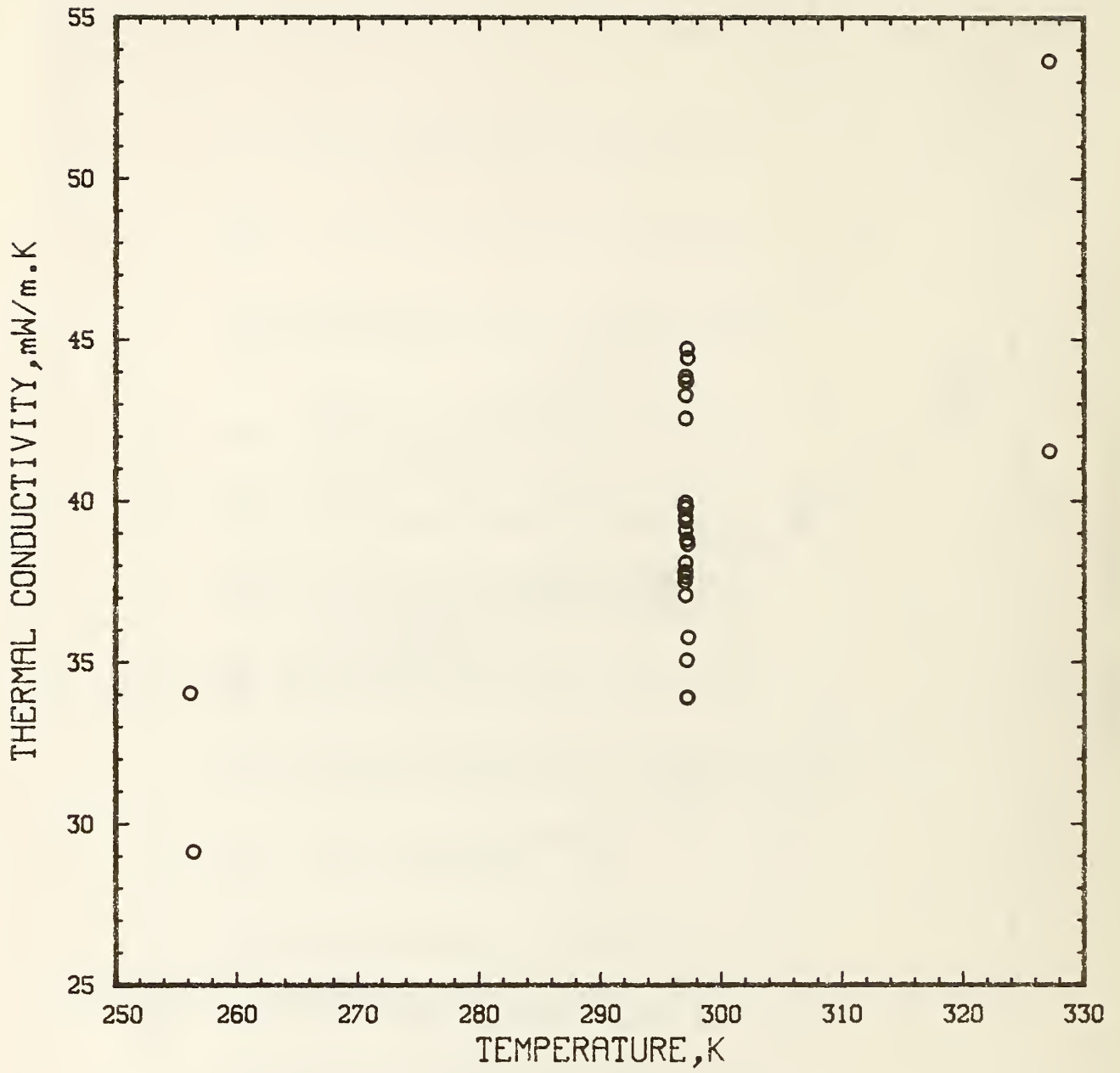

Figure 5.2 Thermal Conductivity versus Temperature of NBS Data on Round Round II and III.

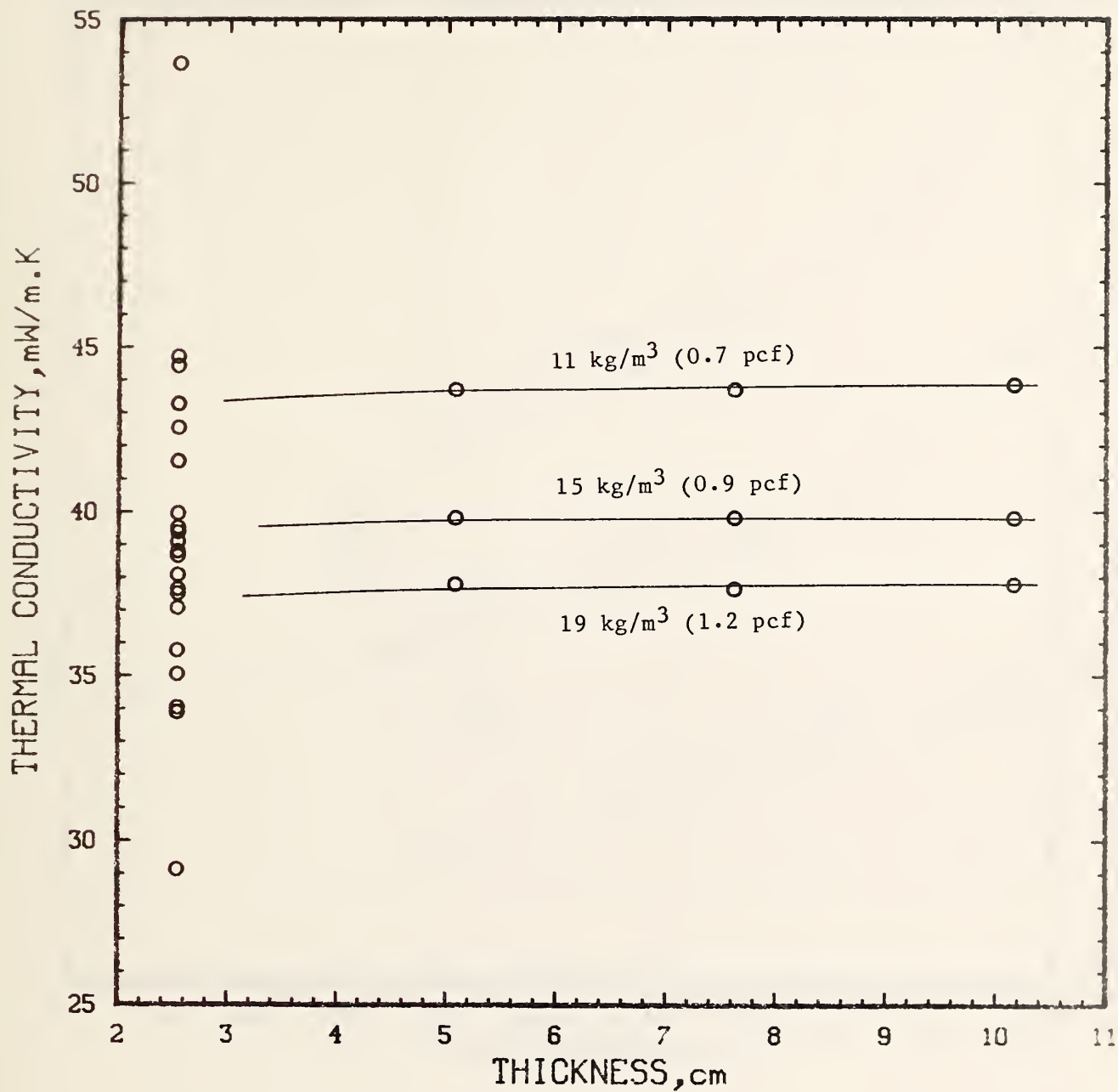

Figure 5.3 Thermal Conductivity versus Thickness of NBS Data on Round Robin II and III. (The lines show the approximate densities of the data at a mean temperature of 297 K.)

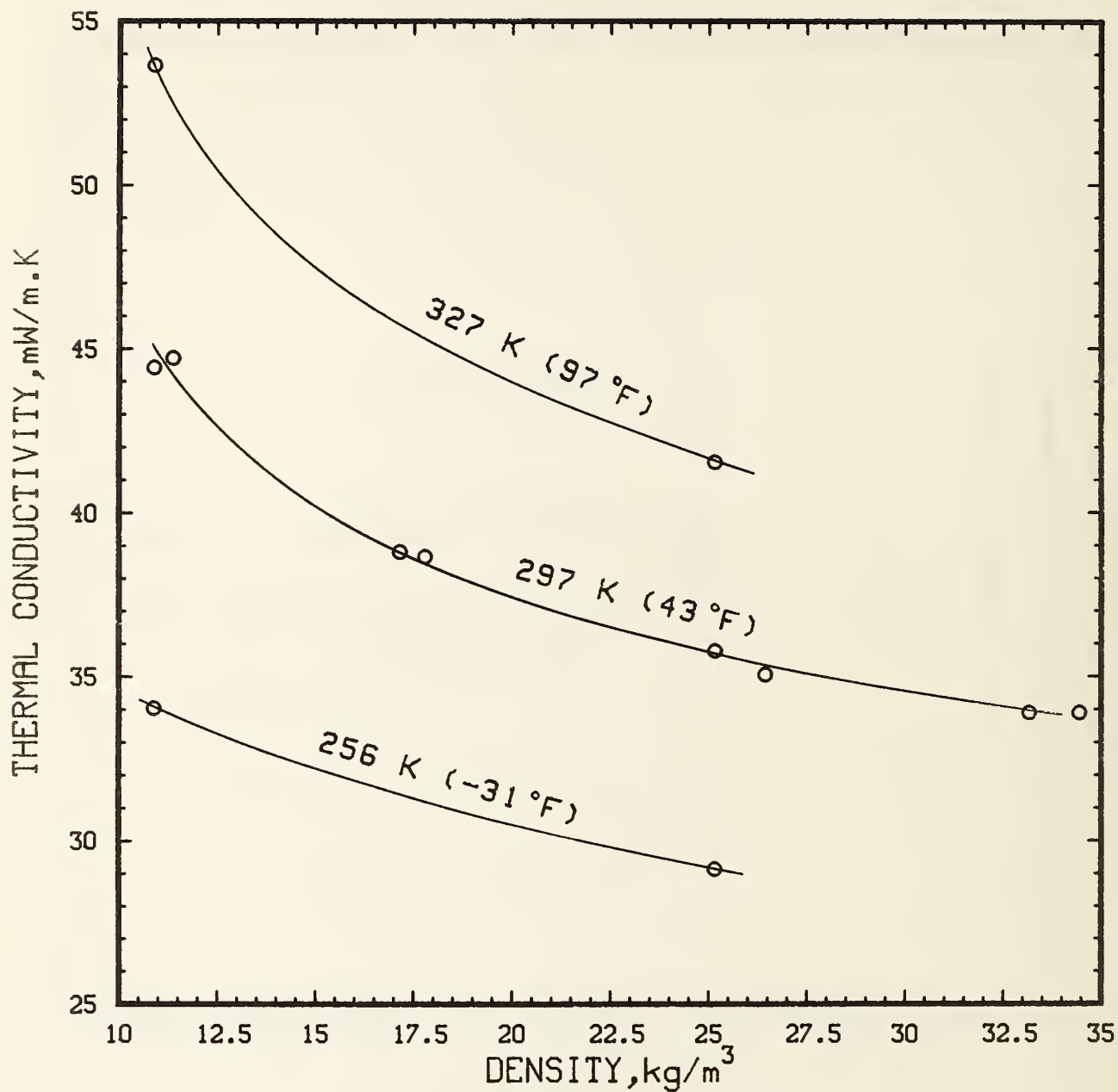

Figure 5.4 Thermal Conductivity versus Density of NBS Data on Round Robin II. (The lines show the approximate temperature of the data.)

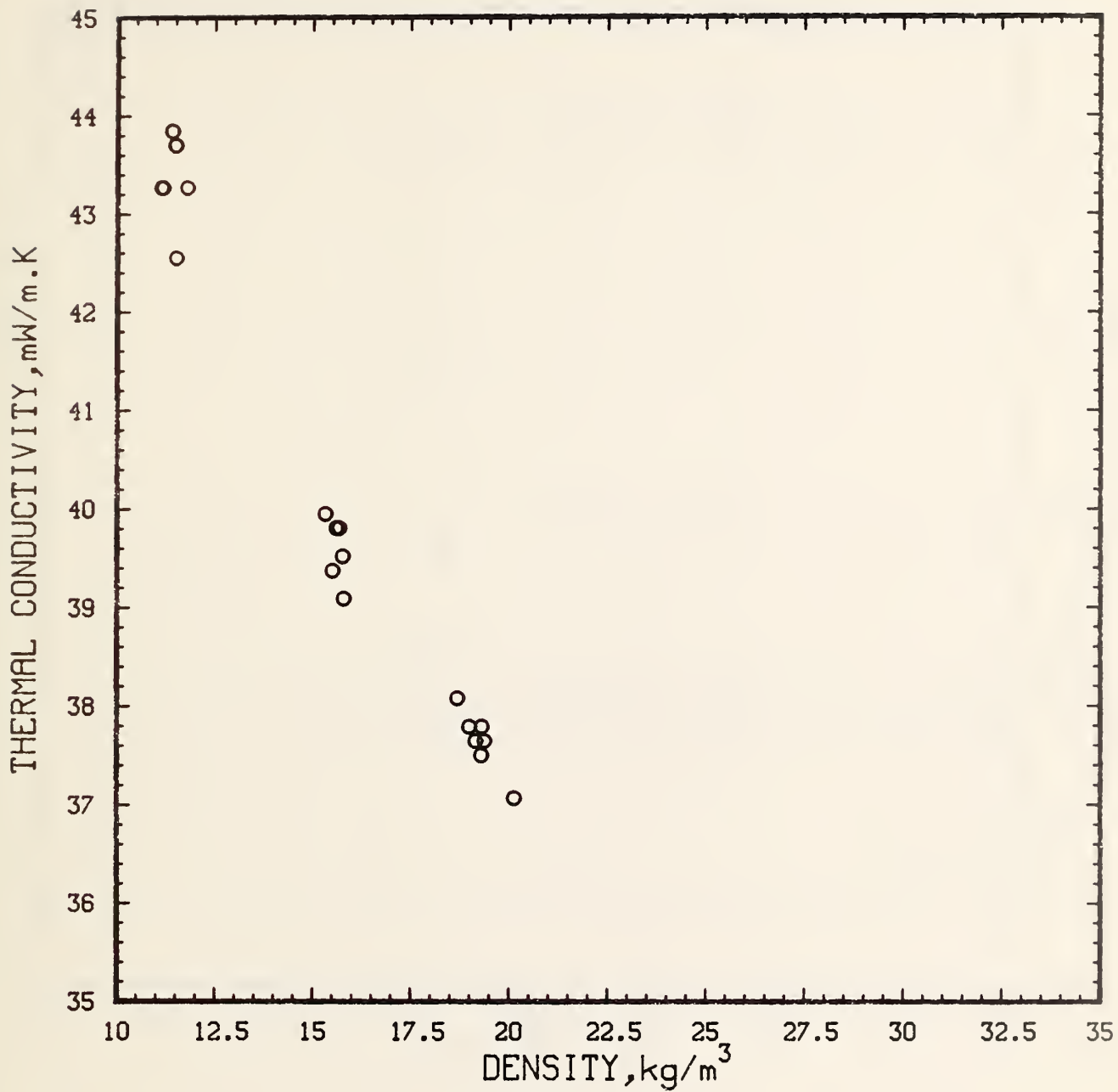

Figure 5.5 Thermal Conductivity versus Density of NBS Data on Round Robin III.

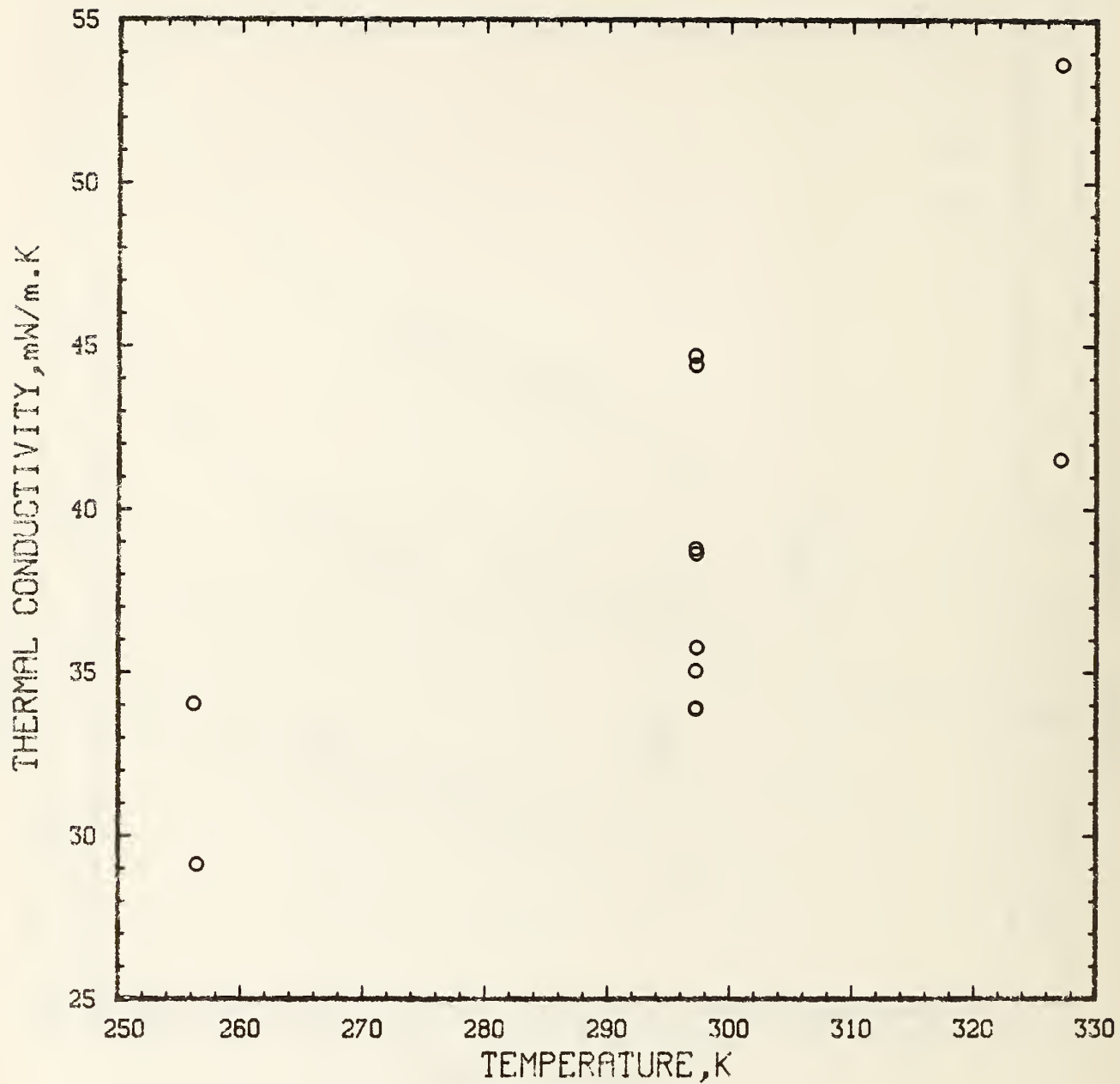

Figure 5.6 Thermal Conductivity versus Temperature of NBS Data on Round Robin II.

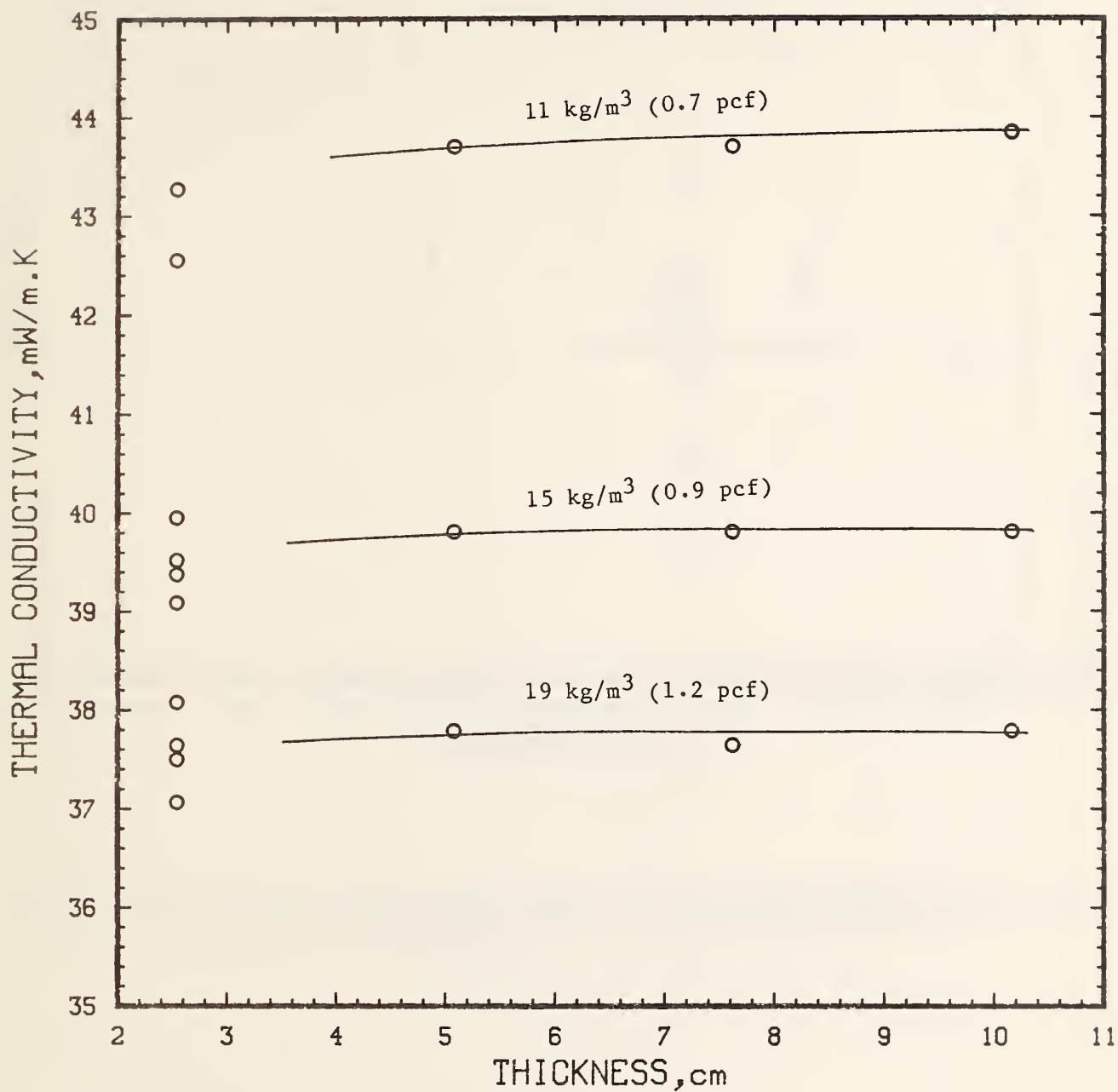

Figure 5.7 Thermal Conductivity versus Thickness of NBS Data on Round Robin III. (The lines show the approximate densities of the data at a mean temperature of 297 K.)

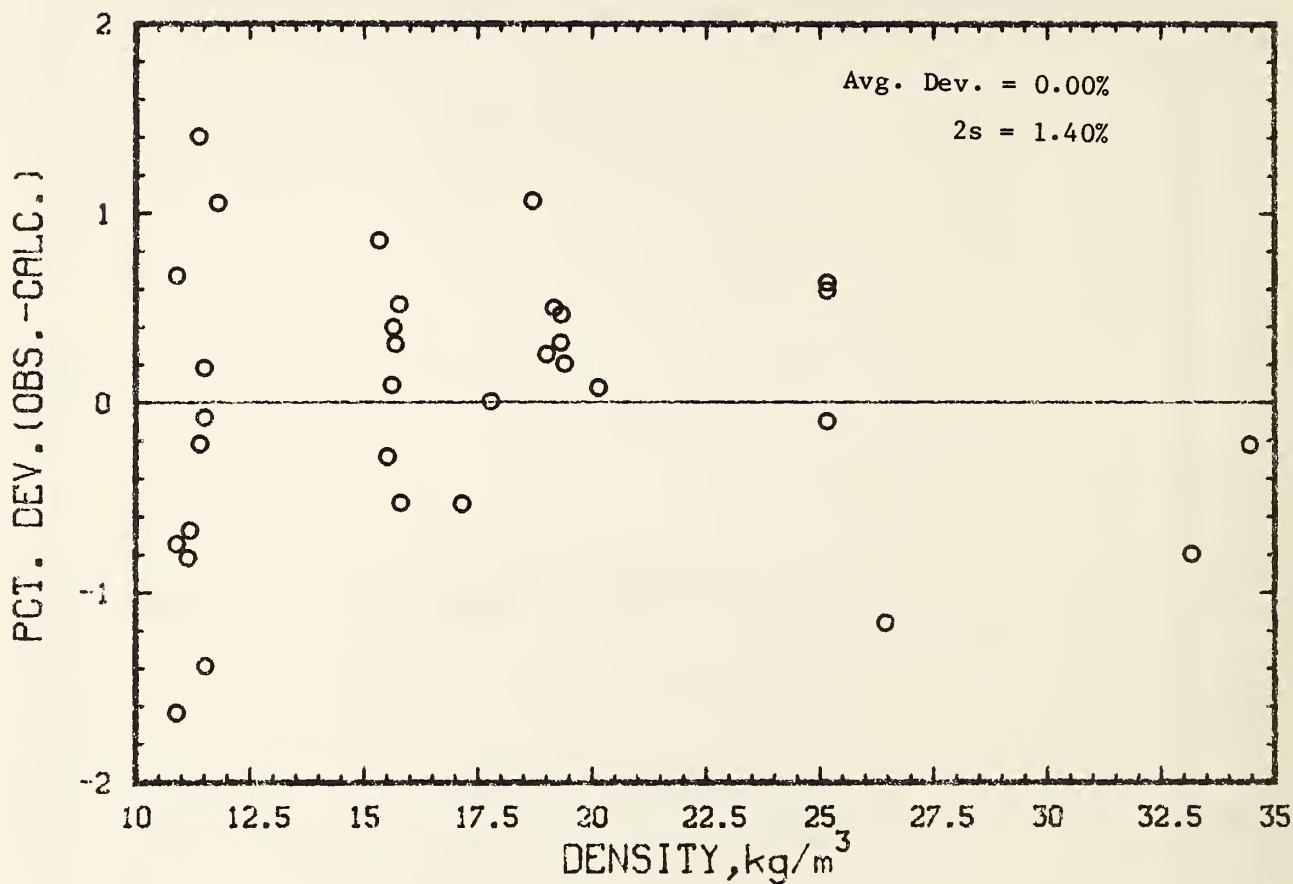

Figure 5.8 Deviations between Thermal Conductivity Data of NBS on Round Robin II and III and Values Calculated from the Model versus Density.

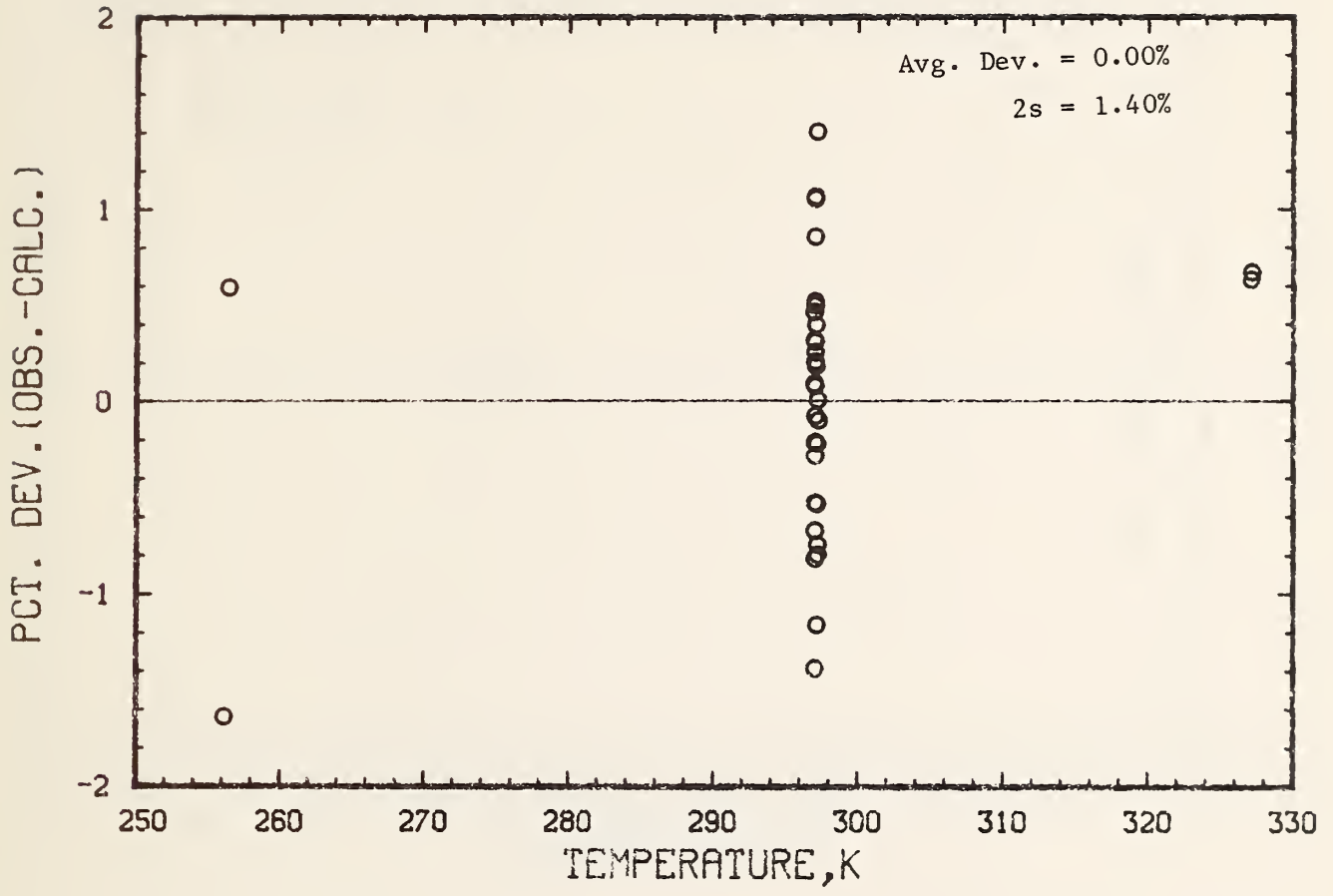

Figure 5.9 Deviations between Thermal Conductivity Data of NBS on Round Robin II and III and Values Calculated from the Model versus Temperature

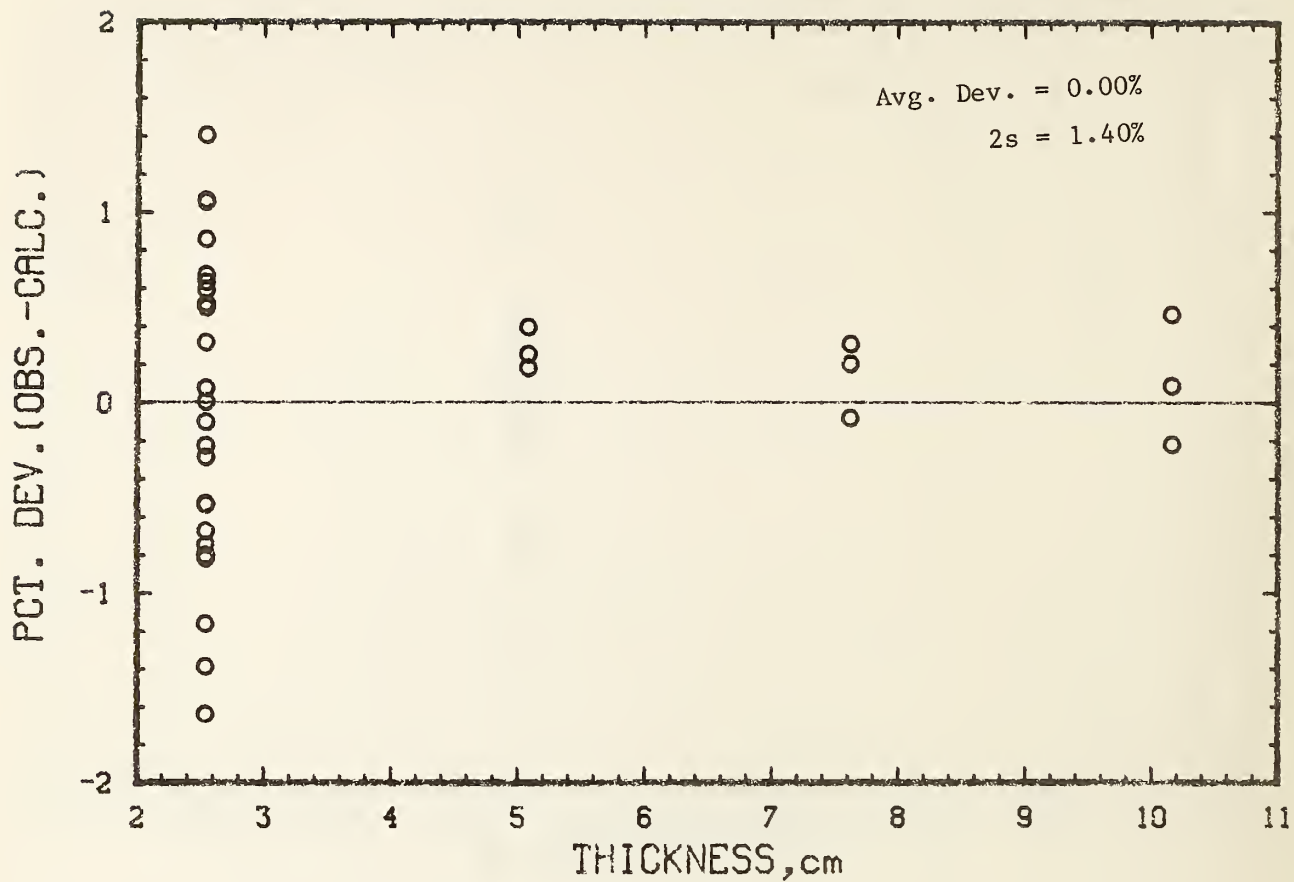

Figure 5.10 Deviations between Thermal Conductivity Data of NBS on Round Robin II and III and Values Calculated from the Model versus Thickness.

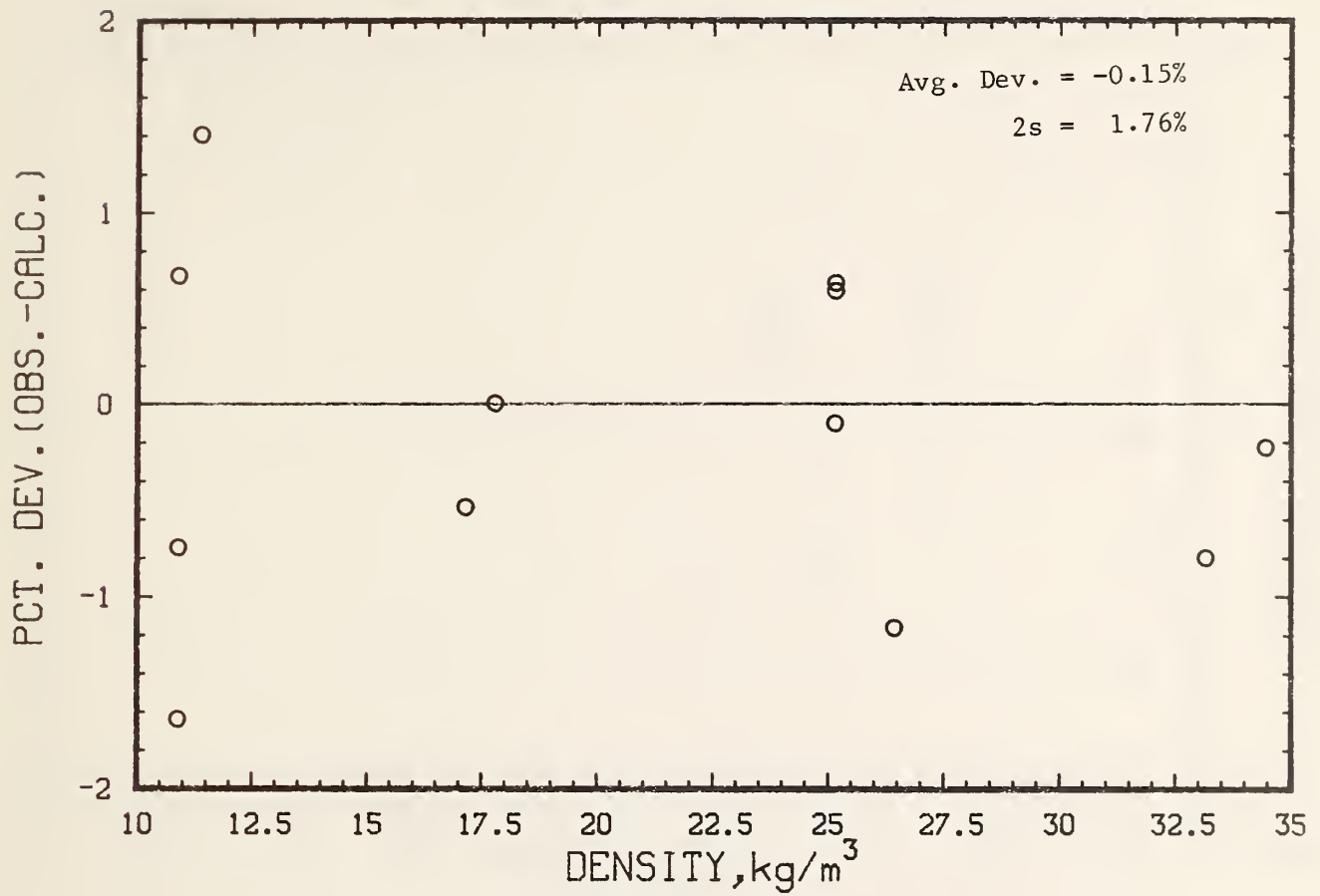

Figure 5.11 Deviations between Thermal Conductivity Data of NBS on Round Robin II and Values Calculated from the Model versus Density.

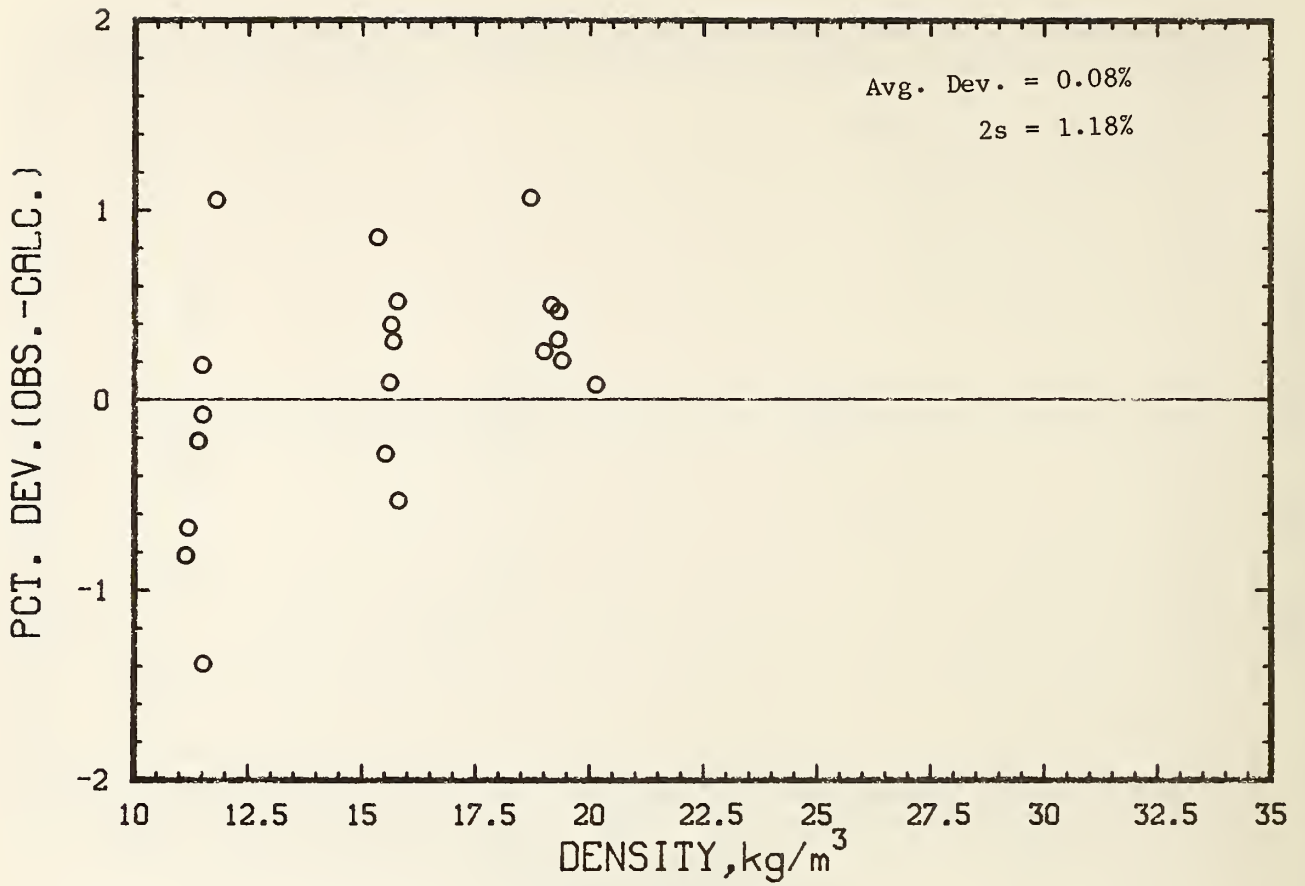

Figure 5.12 Deviations between Thermal Conductivity Data of NBS on Round Robin III and Values Calculated from the Model versus Density.

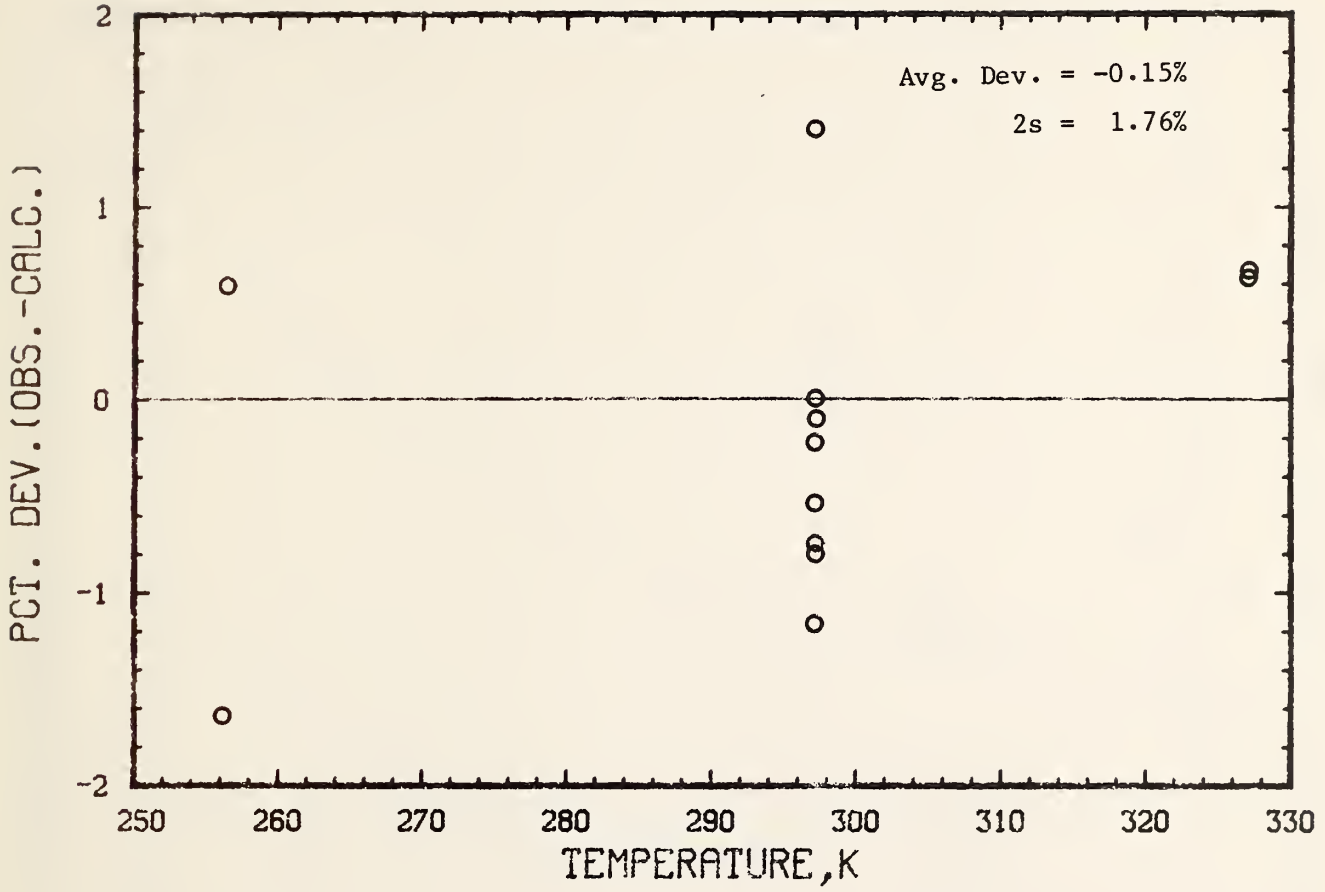

Figure 5.13 Deviations between Thermal Conductivity Data of NBS on Round Robin II and Values Calculated from the Model versus Temperature.

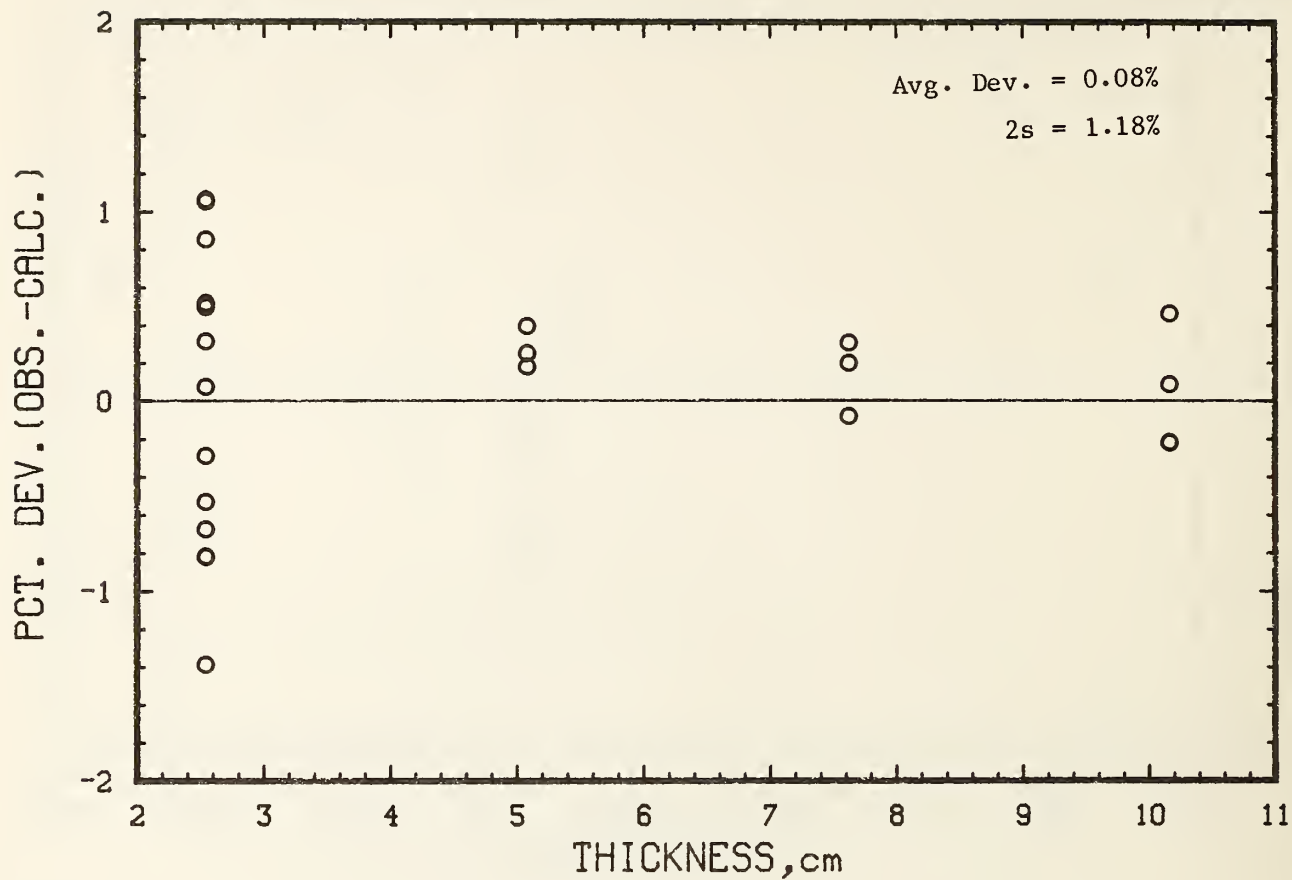

Figure 5.14 Deviations between Thermal Conductivity Data of NBS on Round Robin III versus Thickness.

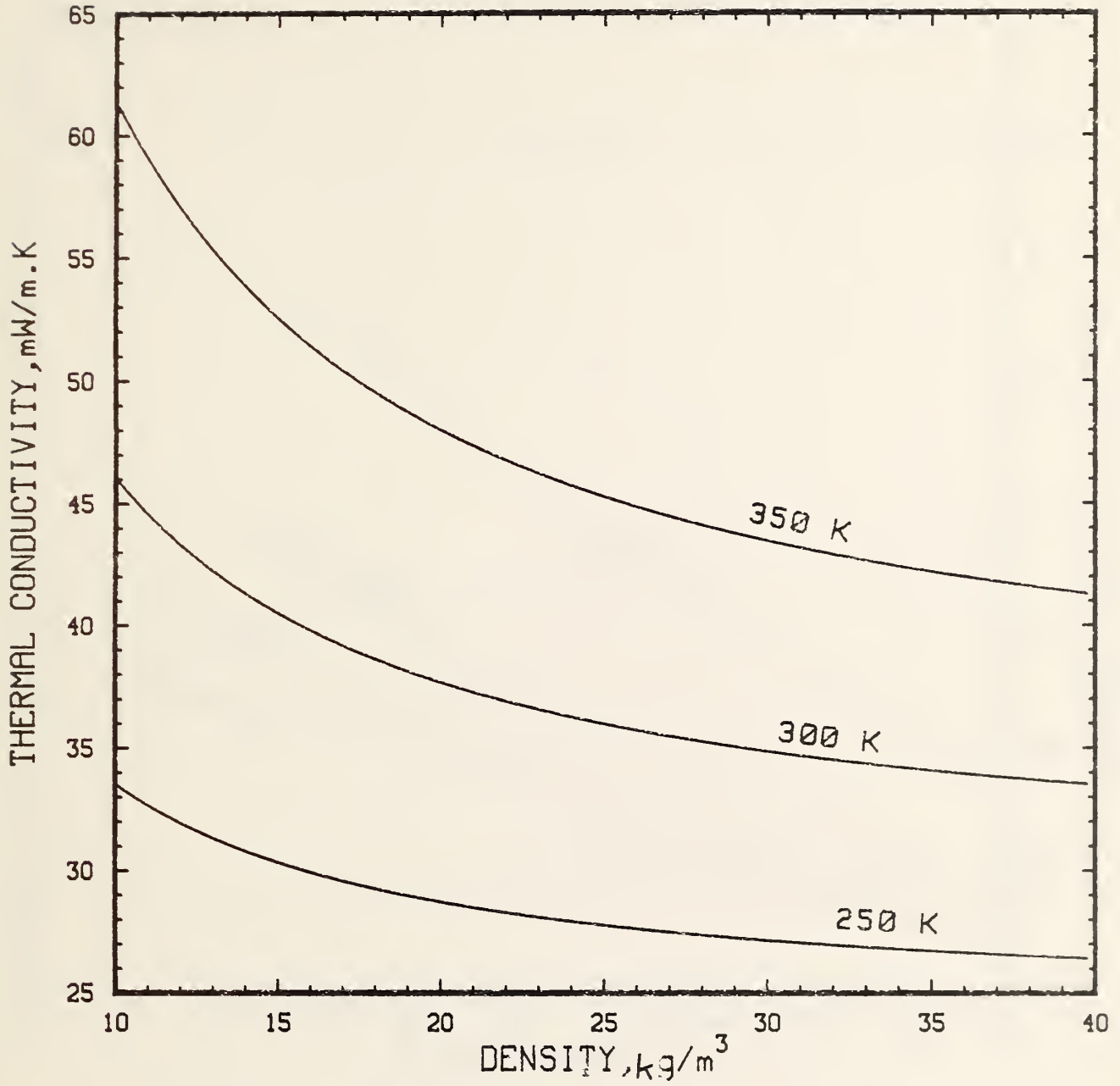

Figure 5.15 Thermal Conductivity versus Density for Several Temperatures as Calculated from the Model. Emittance = 0.95, Thickness = 2.54 cm, and Fiber Diameter = 5.0 μm

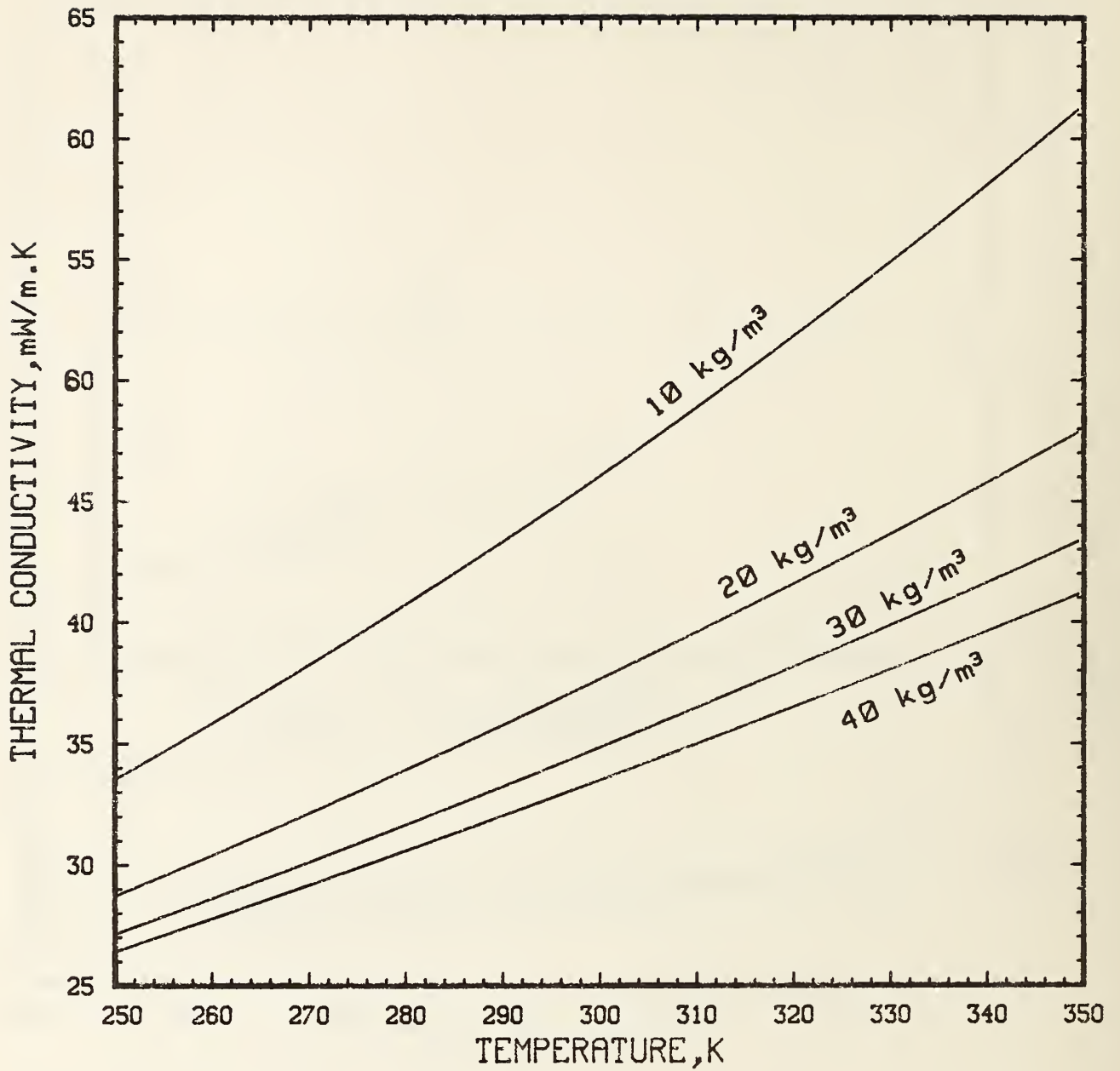

Figure 5.16 Thermal Conductivity versus Temperature for Several Densities as Calculated from the Model. Emittance = 0.95, Thickness = 2.54 cm, and Fiber Diameter = 5.0 μm

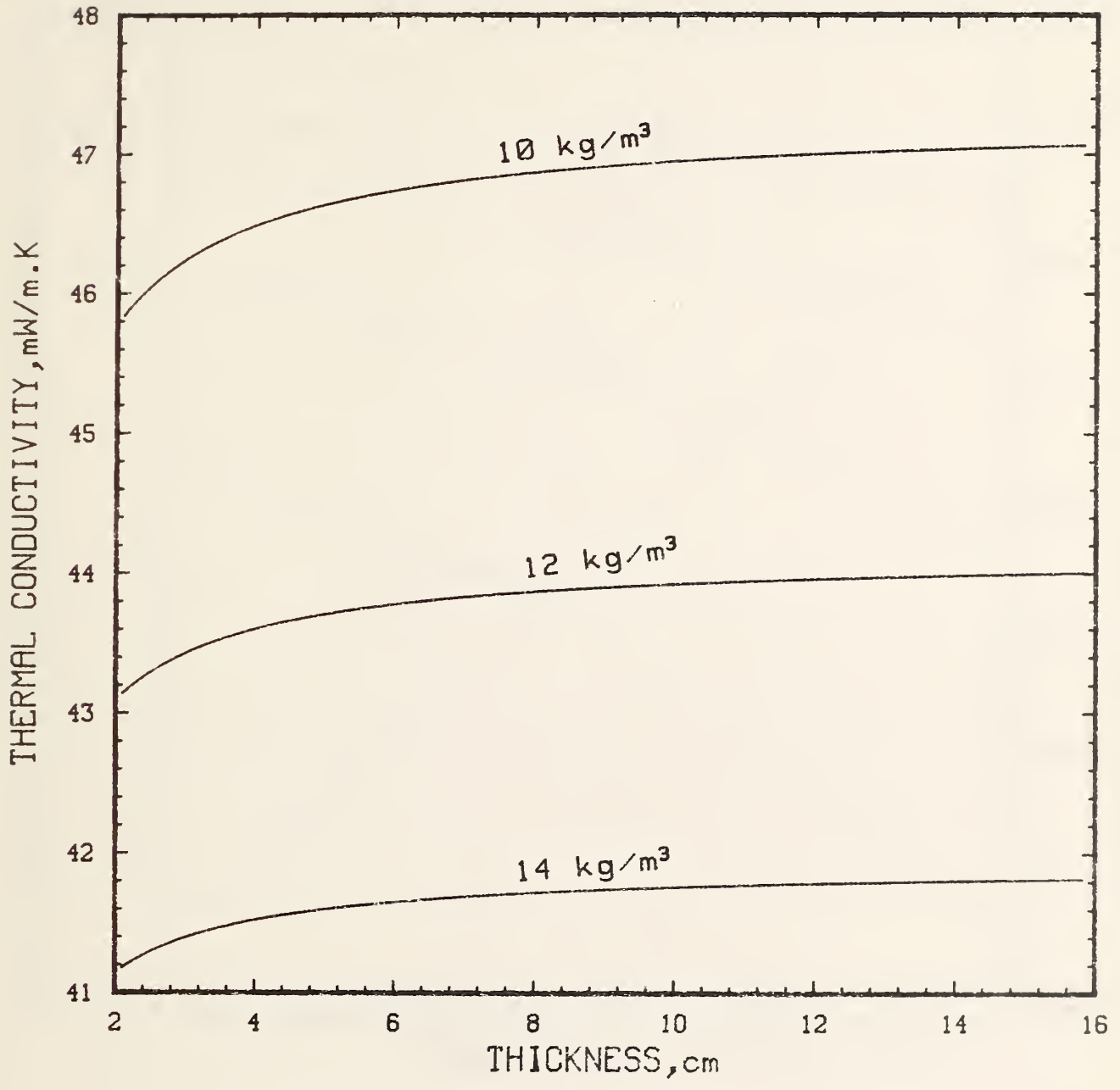

Figure 5.17 Thermal Conductivity versus Thickness for Several Densities as Calculated from the Model. Emittance = 0.95, Temperature = 300 K, and Fiber Diameter = 5.0 μm

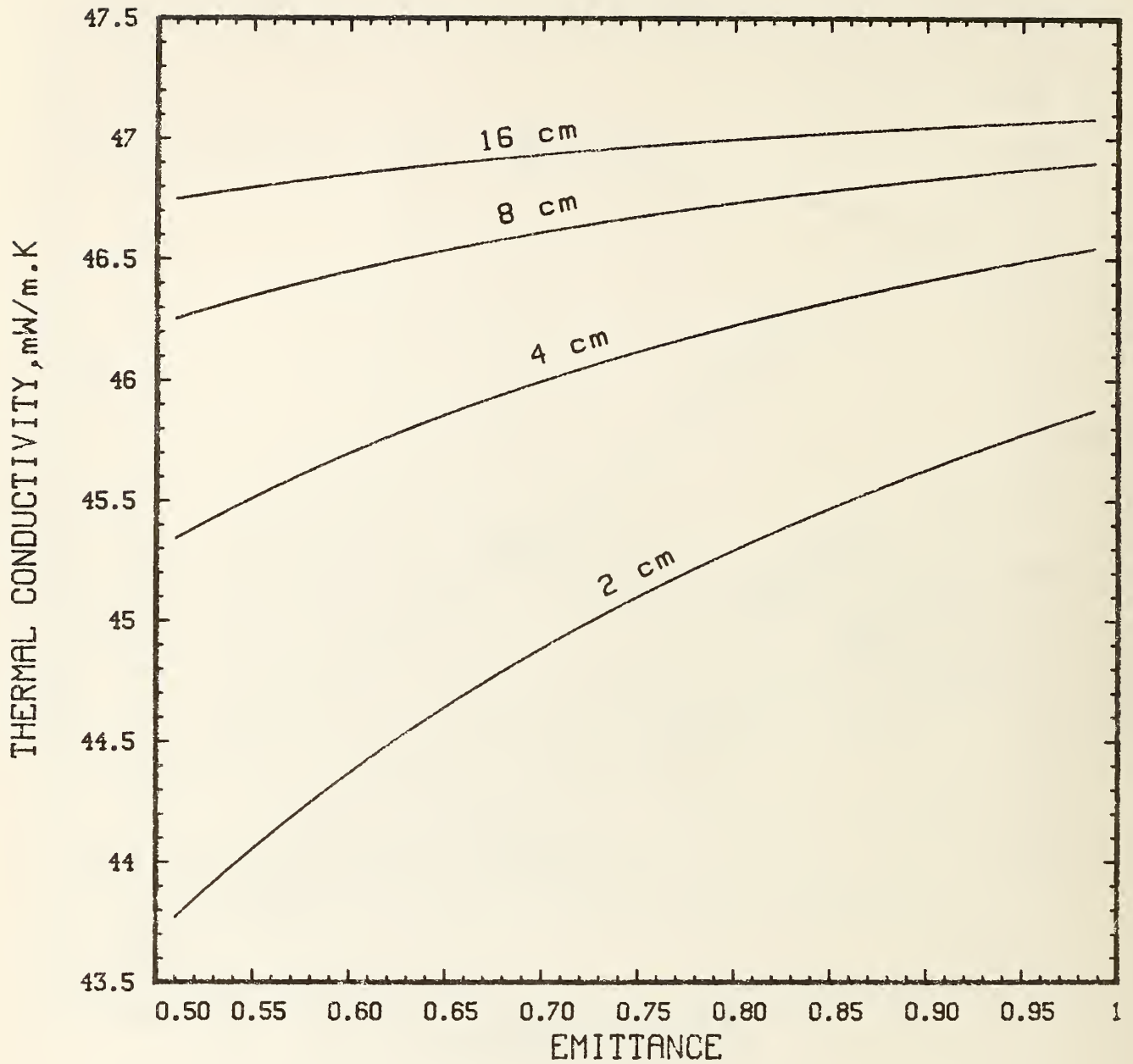

Figure 5.18 Thermal Conductivity versus Emittance for Several Thicknesses as Calculated from the Model. Temperature = 300 K, Density = 10 kg/m³, and Fiber Diameter = 5.0 μm

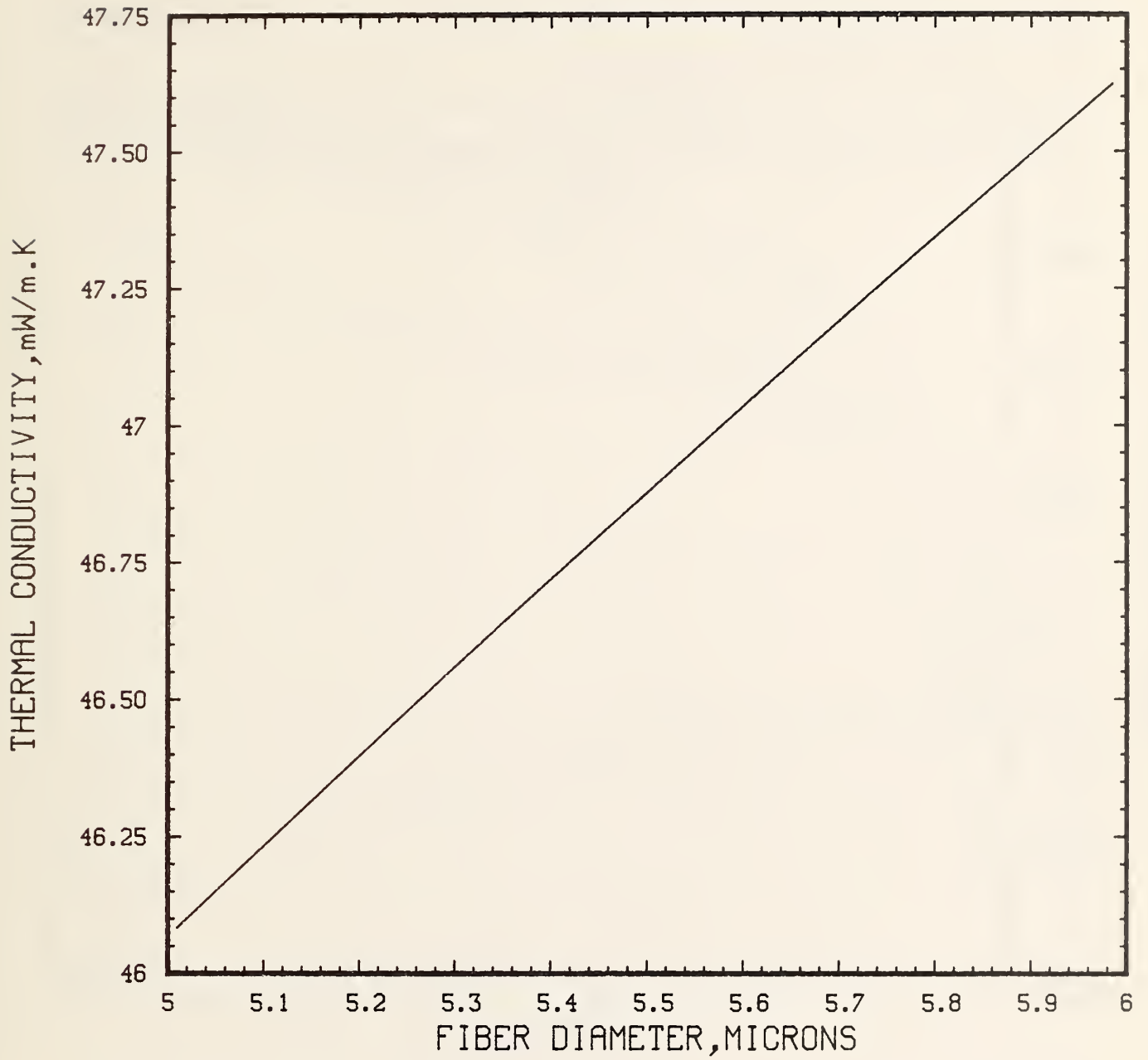

Figure 5.19 Thermal Conductivity versus Fiber Diameter as Calculated from the Model. Emittance = 0.95, Temperature = 300 K, Density = 10 kg/m³, and Thickness = 2.54 cm.

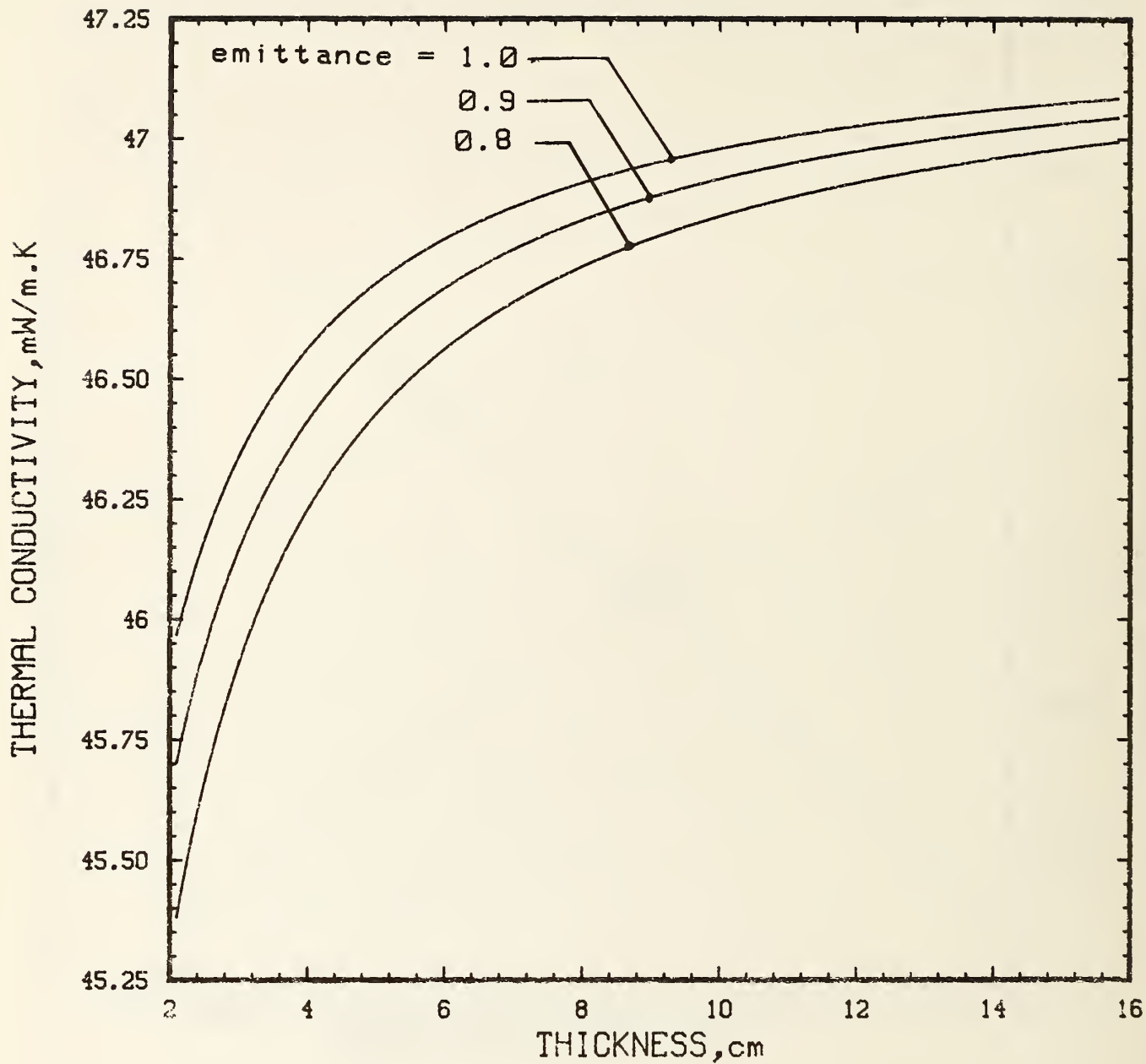

Figure 5.20 Thermal Conductivity versus Thickness for Several Emittances as Calculated from the Model. Temperature = 300 K, Density = 10 kg/m³, and Fiber Diameter = 5.0 μm

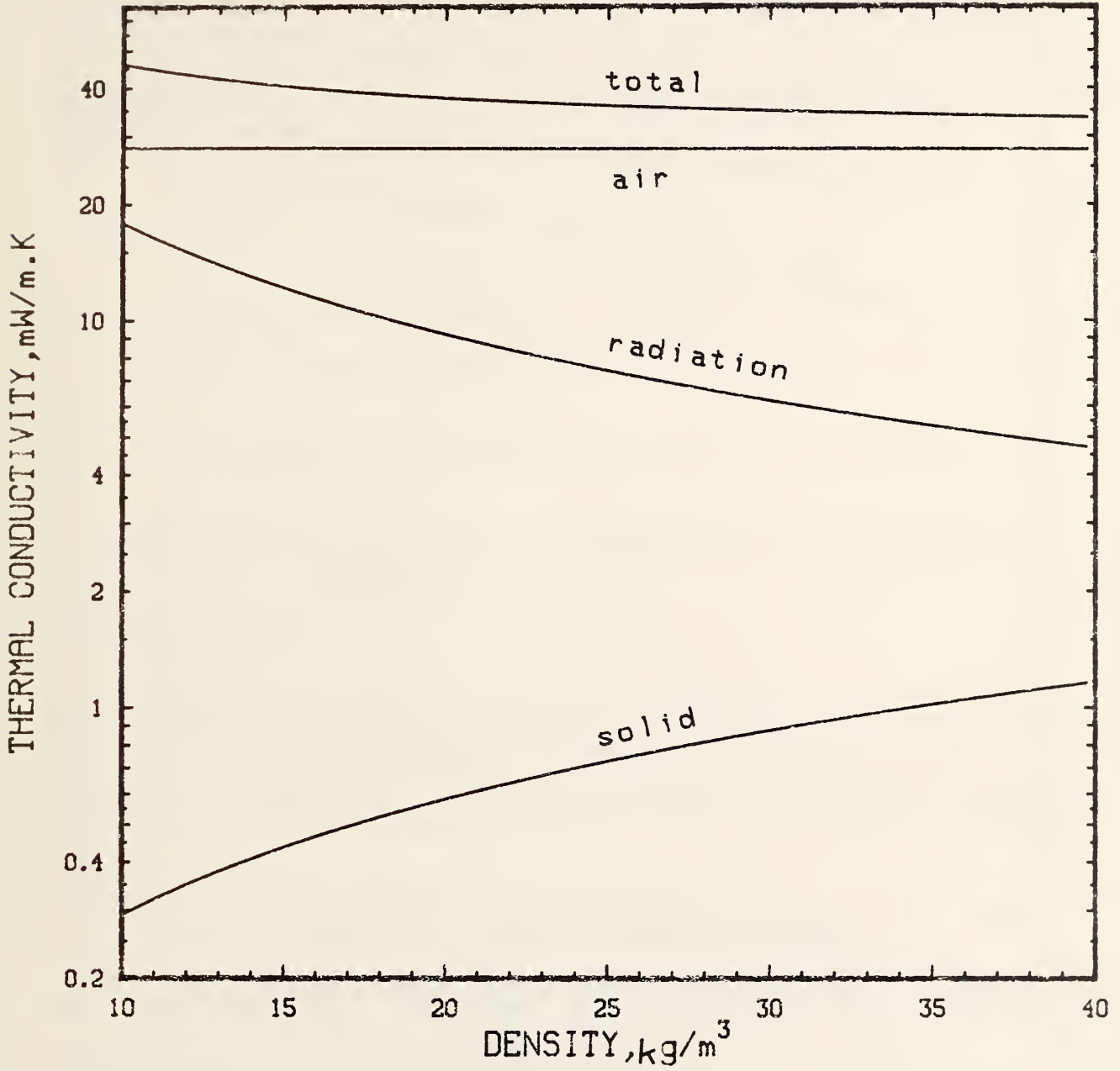

Figure 5.21 Thermal Conductivity Components (air, solid, radiation and total) versus Density as Calculated from the Model. Emittance = 0.95, Temperature = 300 K, Thickness = 2.54 cm, and Fiber Diameter = 5.0 μm

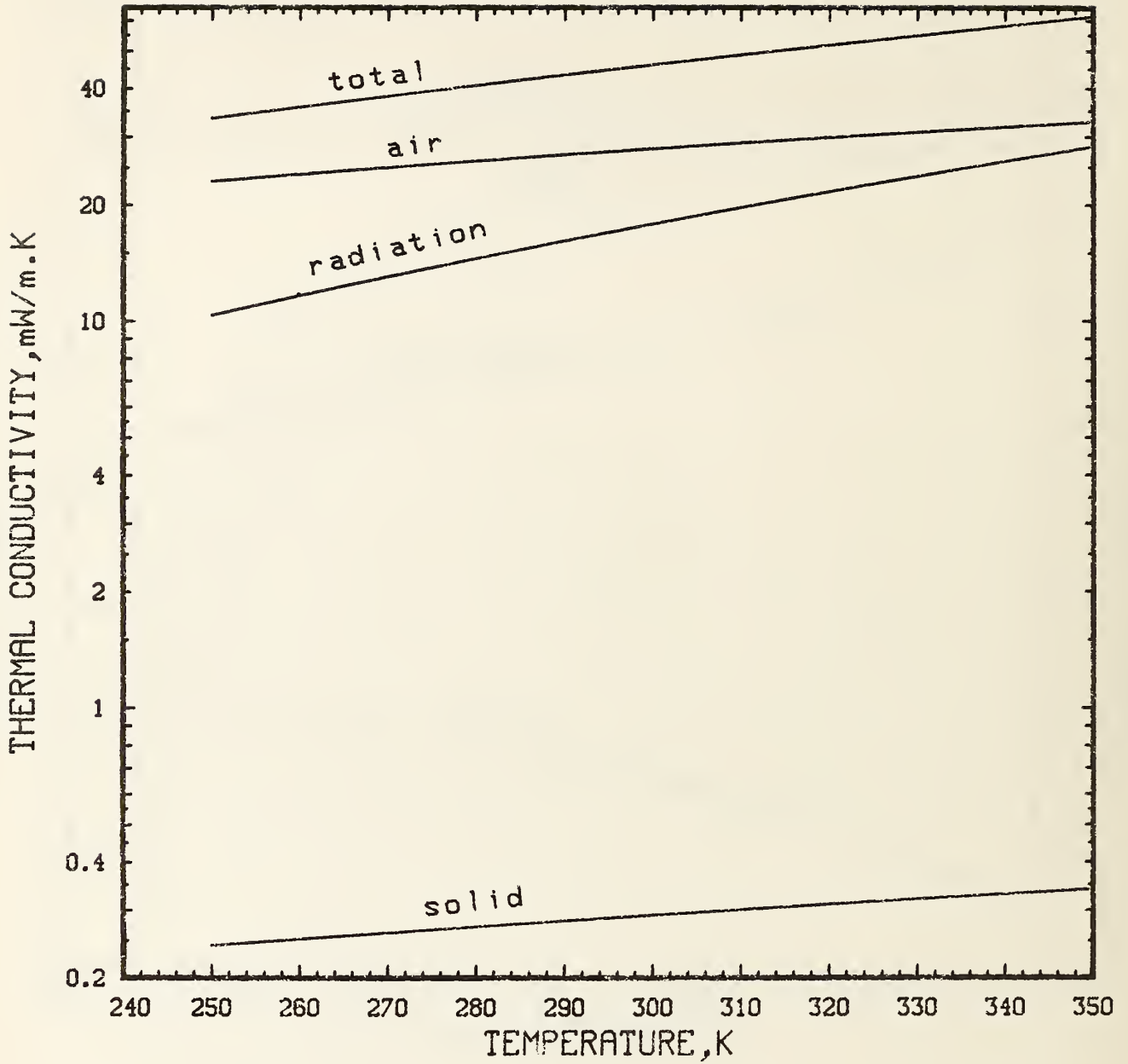

Figure 5.22 Thermal Conductivity Components (air, solid, radiation, and total) versus Temperature as calculated from the Model. Emittance = 0.95, Density = 10 kg/m³, Thickness = 2.54 cm, and Fiber Diameter = 5.0 μm

6. ROUND ROBIN I

6.1 Overview

This round robin, started in September 1976, was initiated in order to evaluate the thermal insulation testing community's capability when measuring building insulation at thicknesses beyond which reference standards were available. The same specimens were circulated among all the participating laboratories. The tests were carried out from September 1976 to June 1980.

The C-16.30 Task Force members were C.M. Pelanne-Chairman, M. Lacher, and S. Cady [19, 20].

The material, R-11 building insulation, used for this round robin was supplied by the Owens-Corning Laboratories in Granville, OH.

Nine HFM's (C518) [2], and three GHP's (C177) [1] were involved in these measurements.

All of the tests were performed at 89 mm (3.5") test thickness and 24°C (75°F) mean temperature.

Tables 6.1, 6.2, and 6.3 show the results of all the measurements as obtained during the course of this round robin. Further explanation of these tables is given in the appendix.

6.2 Test Specimens

The specimens consisted of four, 8.9 cm (3.5") thick, 38.7 cm (15.25") wide and 122 cm (48") long R-11 friction fit building insulation batts. The batts were obtained from the center of a package of standard building insulation selected at random from stock. The batts were identified by a series of single numbers, 8, 9, 10 and 11. The actual test densities determined for these specimens ranged from 12.3 kg/m³ (0.77 lb/ft³) to 14.6 kg/m³ (0.91 lb/ft³).

In order for the specimens to conform to the various equipment sizes, similar insulation material was used for peripheral guarding.

The densities were determined on the total specimen and, in order to relate the test density to the test area of the apparatus, the specimens were cut and weighed to successively smaller sizes matching the test areas. Thus for this series of tests eighteen individual density determinations were made. The details of these measurements are given in Table 13.4.

6.3 Test Equipment

The apparatus involved in this round robin were as follows;

Apparatus type	Number	Overall size	Test area
Heat flow meter	1	915×915 mm (36×36 in)	406×406 mm (16×16 in)
" " "	2	915×915 mm (36×36 in)	305×305 mm (12×12 in)
" " "	6	610×610 mm (24×24 in)	254×254 mm (10×10 in)
Guarded hot plate	2	610×610 mm (24×24 in)	305×305 mm (12×12 in)
" " "	1	457×457 mm (18×18 in)	305×305 mm (12×12 in)

6.4 Results

The apparent thermal conductivity data obtained during this round robin are plotted in Figures 6.1 to 6.4. Figure 6.1 shows the 915-406mm (4 points) and the 915-305mm (12 points) HFM data. Figure 6.2 shows the 610-254mm (22 points) HFM data. All of these data were obtained on single specimens. The GHP data are plotted in Figure 6.3. These data (8 points) represent results of tests on pairs of matched specimens. Figure 6.4 is a composite plot of all of the 46 data points. All of these tests were performed at 24°C (75°F) mean temperature and 89 mm (3.5") test thickness.

The deviations of the RR I data from the model described earlier are shown in Figures 6.5 to 6.8 in the same sequence as Figures 6.1 to 6.4. The deviations (observed - calculated) are also listed in the last column of Tables 6.1, 6.2, and 6.3. The average deviation from the model and the 2s value for each subset of data are shown on each deviation plot.

As mentioned earlier the tests were performed over a long period of time (September 1976 - June 1980). In order to verify that the thermal resistance of each specimen had not changed over the extent of the project, they were periodically measured by laboratory 17. These results (Table 6.4 and Figures 6.9 and 6.10), while obtained on two separate apparatus*, showed no detectable change with time and use, as shown on Figure 6.11.

Figure 6.8, which is a composite of the deviations shows that the inter-laboratory differences range about 2.5% on either side of the experimental mean values. The model values are about 1.5% greater than the mean experimental values. This systematic difference is probably because these specimens were supplied by a different manufacturer than those used in RR II and III.

*Note-The calibration of the two apparatus was assured through the same reference specimens.

RR I data were not used to optimize the parameters in the model. The intra-laboratory scatter is about one-third of the interlaboratory scatter. There does not appear to be any significant trend between the HFM and GHP results.

Since the three round robins are closely related, detailed discussion of the significance of these is relegated to section 9 of this report.

Table 6.1 ASTM C-16.30/MIMA Round Robins. Data from the 915-406 mm and 915-305 mm Heat Flow Meter Apparatus for Round Robin I.

RR NO.	LAB NO.	DATE M Y	EQUIP TYPE	TEST COND.	SPEC. NO.	THICK. cm	DENS. kg/m ³	HOT TEMP	COLD TEMP	MEAN TEMP	k mW/(m ² ·K)	FOOT-NOTES	PCT.
I 12	I 12	0976	H3616	108	1	8.89	12.91	308.2	285.9	297.0	42.3	s	-0.5
I 12	I 12	0976	H3616	108	3	8.89	13.33	308.2	285.9	297.0	41.5	s	-1.2
I 12	I 12	0976	H3616	108	2	8.89	12.33	308.2	285.9	297.0	42.7	s	-1.0
I 12	I 12	0976	H3616	108	4	8.89	12.54	308.2	285.9	297.0	42.1	s	-1.8
I 16	I 16	0677	H3612	108	1	8.89	13.17	311.7	283.3	297.5	42.4		0.3
I 16	I 16	0677	H3612	108	3	8.89	14.10	311.7	283.3	297.5	41.7		0.7
I 16	I 16	0677	H3612	108	2	8.89	12.53	311.6	283.3	297.4	43.0		-0.0
I 16	I 16	0677	H3612	108	4	8.89	13.23	311.7	283.3	297.5	42.8		1.4
I 17	I 17	0976	H3612	108	1	8.89	13.17	308.3	286.0	297.2	41.2		-2.4
I 17	I 17	0976	H3612	108	1	8.89	13.17	308.0	285.9	297.0	41.5		-1.6
I 17	I 17	1076	H3612	108	3	8.89	14.10	308.3	285.7	297.0	41.2		-0.1
I 17	I 17	1076	H3612	108	3	8.89	14.10	308.6	285.8	297.2	41.2		-0.4
I 17	I 17	1076	H3612	108	3	8.89	14.10	308.2	285.8	297.0	41.0		-0.8
I 17	I 17	1076	H3612	108	2	8.89	12.53	308.3	286.0	297.2	42.5		-0.9
I 17	I 17	1076	H3612	108	2	8.89	12.53	308.2	285.9	297.0	43.0		0.2
I 17	I 17	1076	H3612	108	4	8.89	13.23	308.2	286.0	297.1	42.7		1.2

s: Start of program

Table 6.2. ASTM C-16.30/MIMA Round Robins. Data from 610-254 mm Heat Flow Meter Apparatus for Round Robin I.

RR NO.	LAB NO.	DATE M Y	EQUIP TYPE	TEST COND.	SPEC. NO.	THICK. cm	DENS. kg/m ³	HOT TEMP	COLD TEMP	MEAN TEMP	k mW/(m ² ·K)	FOOT-NOTES	PCT
I 13	13	0778	H2410	108	1	8.89	12.91	311.6	283.7	297.7	42.3		-0.9
I 13	13	0778	H2410	108	3	8.89	14.56	311.7	283.4	297.5	40.8		-0.4
I 13	13	0778	H2410	108	2	8.89	12.41	311.5	283.4	297.5	42.7		-1.1
I 13	13	0778	H2410	108	4	8.89	13.78	311.6	283.4	297.5	41.8		0.3
I 14	14	0578	H2410	108	1	8.89	12.91	311.0	283.4	297.2	42.4		-0.3
I 14	14	0578	H2410	108	3	8.89	14.56	311.2	283.4	297.3	40.4		-1.4
I 14	14	0578	H2410	108	2	8.89	12.41	311.2	283.5	297.3	42.3		-2.0
I 14	14	0578	H2410	108	4	8.89	13.78	311.2	283.5	297.4	41.0		-1.7
I 18	18	0477	H2410	108	1	8.89	12.91	311.4	283.4	297.4	41.8		-1.8
I 18	18	9477	H2410	108	2	8.89	12.41	311.3	283.4	297.3	42.0		-2.7
I 18	18	79	H2410	108	1	8.89	12.91	311.2	283.4	297.3	41.0		-3.9
I 18	18	79	H2410	108	3	8.89	14.56	311.5	283.4	297.5	39.5		-3.7
I 18	18	79	H2410	108	2	8.89	12.41	312.0	283.4	297.4	41.4		-4.2
I 18	18	79	H2410	108	4	8.89	13.78	311.5	283.4	297.5	39.8		-4.8
I 20	20	1077	H2410	108	1	8.89	12.91	310.7	283.1	296.9	41.5	c	-2.1
I 20	20	1077	H2410	108	3	8.89	14.56	310.7	283.0	296.9	40.5	c	-0.8
I 20	20	1077	H2410	108	2	8.89	12.41	310.7	283.1	296.9	42.1	c	-2.1
I 20	20	1077	H2410	108	4	8.89	13.78	310.7	283.0	296.8	41.1	c	-1.1
I 21	21	1177	H2410	108	1	8.89	12.91	311.0	283.8	297.4	42.0		-1.4
I 21	21	1177	H2410	108	3	8.89	14.56	310.9	283.8	297.4	40.5		-1.1
I 21	21	1177	H2410	108	2	8.89	12.41	311.0	284.0	297.5	42.3		-2.1
I 21	21	1177	H2410	108	4	8.89	13.78	311.0	284.0	297.5	41.4		-0.8

c: The data were calculated on the basis of two reference bases. The second constant yielded k_a values 2% lower than those listed.

Table 6.3. ASTM C-16.30/MIMA Round Robins. Data from the Guarded Hot Plate Apparatus for Round Robin I.

RR NO.	LAB NO.	DATE M Y	EQUIP TYPE	TEST COND.	SPEC. NO.	THICK. cm	DENS. Kg/m ³	HOT TEMP	COLD TEMP	MEAN TEMP	k mW/(m ² ·K)	FOOT-NOTES	PCT
I 15	15	0877	G2412	208	1	8.89	13.63	308.1	285.9	297.0	40.7		-2.6
I 15	15	0877	G2412	208	2	8.89	12.88	308.1	285.9	297.0	41.5		-2.3
I 15	15	0877	G1812	208	1	8.89	13.63	308.2	285.9	297.0	40.5		-3.0
I 15	15	0877	G1812	208	2	8.89	12.88	308.0	285.8	296.9	41.2		-3.0
I 18	18	0477	G2412	208	1	8.89	13.63	308.7	285.0	296.9	42.3		1.3
I 18	18	0477	G2412	208	2	8.89	12.88	309.9	286.0	297.9	43.0		0.6
I 18	18	79	G2412	208	1	8.89	13.63	311.1	283.2	297.2	41.2	a	-1.2
I 18	18	79	G2412	208	2	8.89	12.88	310.9	283.3	297.0	41.1	a	-3.4

a: Equipment rebuilt between two sets of data.

Table 6.4 ASTM C-16.30/MIMA Round Robins. Data from Lab 17 over the Time Period from 1976 to 1980 for Round Robin I.

RR NO.	LAB NO.	DATE M Y	EQUIP TYPE	TEST COND.	SPEC. NO.	THICK. cm	DENS. kg/m ³	HOT TEMP	COLD TEMP	MEAN TEMP	k mw/(ft ² ·K)	FOOT-NOTES	PCT
I 17	17	0976	H3612	108	1	8.89	13.17	308.3	286.0	297.2	41.2		-2.4
I 17	17	0976	H3612	108	1	8.89	13.17	308.0	285.9	297.0	41.5		-1.6
I 17	17	1076	H3612	108	3	8.89	14.10	308.3	285.7	297.0	41.2		-0.1
I 17	17	1076	H3612	108	3	8.89	14.10	308.6	285.8	297.2	41.2		-0.4
I 17	17	1076	H3612	108	3	8.89	14.10	308.2	285.8	297.0	41.0		-0.8
I 17	17	1076	H3612	108	2	8.89	12.53	308.3	286.0	297.2	42.5		-0.9
I 17	17	1076	H3612	108	2	8.89	12.53	308.2	285.9	297.0	43.0		0.2
I 17	17	1076	H3612	108	4	8.89	13.23	308.2	286.0	297.1	42.7		1.2
I 17	17	0277	H3612	108	1	8.89	13.17	308.2	285.9	297.0	41.5		-1.6
I 17	17	0277	H3612	108	3	8.89	14.10	308.2	285.9	297.0	41.0		-0.8
I 17	17	0277	H3612	108	2	8.89	12.53	308.2	285.9	297.0	42.7		-0.5
I 17	17	0277	H3612	108	4	8.89	13.23	308.2	285.9	297.0	41.4		-1.8
I 17	17	0178	H3612	108	1	8.89	13.17	308.0	286.1	297.0	42.3		0.1
I 17	17	0178	H3612	108	3	8.89	14.10	308.0	286.0	297.0	41.2		-0.1
I 17	17	0178	H3612	108	2	8.89	12.53	308.1	286.0	297.1	42.5		-0.8
I 17	17	0178	H3612	108	4	8.89	13.23	308.2	285.9	297.0	42.1		-0.0
I 17	17	0378	H2410	108	1	8.89	12.91	310.7	283.2	297.0	42.8		0.9
I 17	17	0378	H2410	108	1	8.89	12.91	310.7	283.2	296.9	42.8		0.9
I 17	17	0378	H2410	108	3	8.89	14.56	310.8	283.3	297.0	41.1		0.5
I 17	17	0378	H2410	108	3	8.89	14.56	310.8	283.2	297.0	41.1		0.5
I 17	17	0378	H2410	108	2	8.89	12.41	310.8	283.3	297.0	43.1		0.3
I 17	17	0378	H2410	108	2	8.89	12.41	310.8	283.2	297.0	43.4		0.9
I 17	17	0378	H2410	108	4	8.89	13.78	310.8	283.3	297.0	41.5		-0.1
I 17	17	0378	H2410	108	4	8.89	13.78	310.8	283.2	297.0	41.7		0.2
I 17	17	0680	H2410	108	1	8.89	12.91	310.9	283.2	297.0	41.8		-1.5
I 17	17	0680	H2410	108	3	8.89	14.56	310.9	283.2	297.0	40.5		-0.9
I 17	17	0680	H2410	108	2	8.89	12.41	310.9	283.2	297.0	42.4		-1.5
I 17	17	0680	H2410	108	4	8.89	13.78	311.0	283.2	297.1	41.0		-1.5

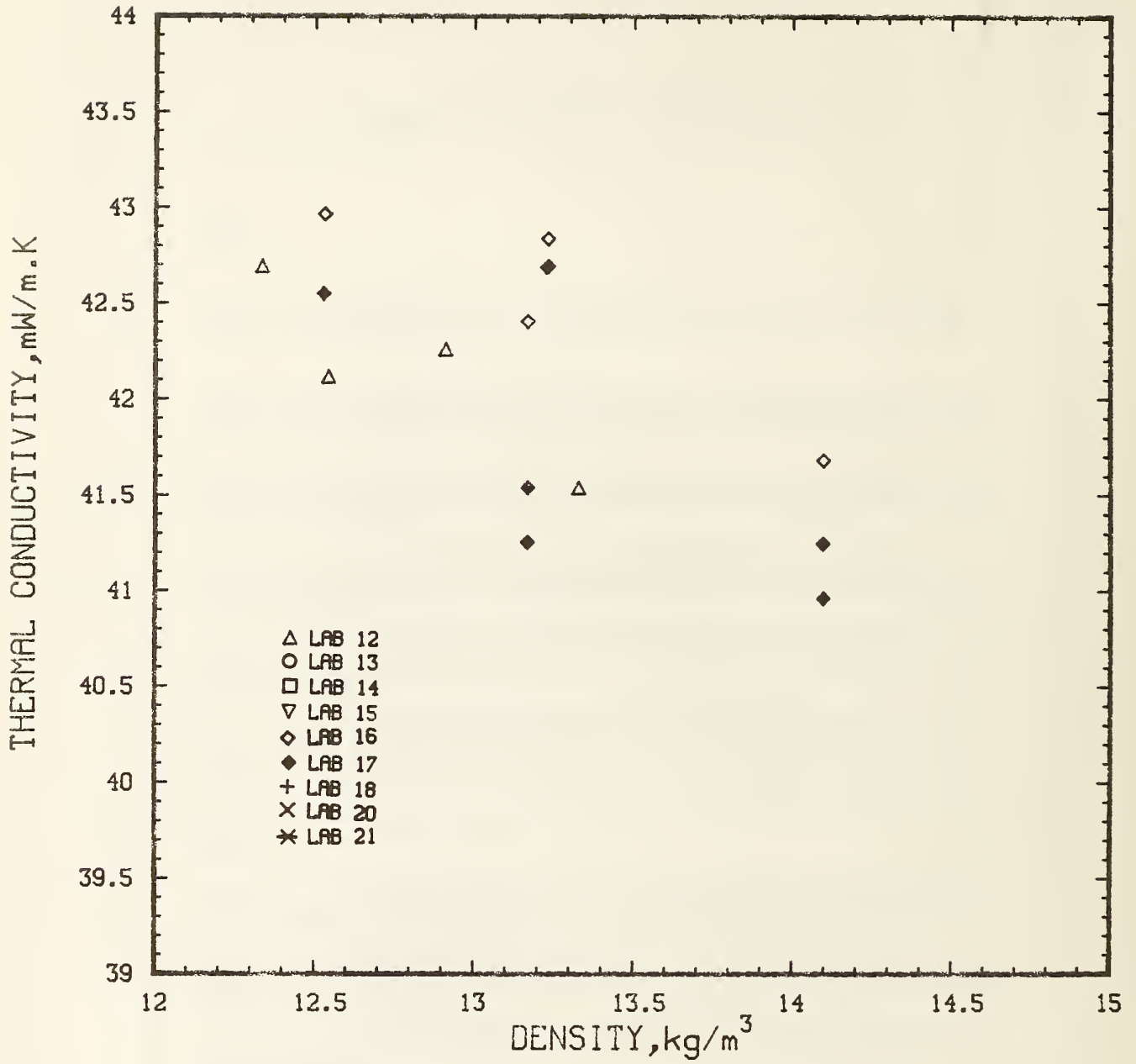

Figure 6.1 Thermal Conductivity versus Density for the 915-406 mm and 915-305 mm Heat Flow Meter Apparatus from Round Robin I.

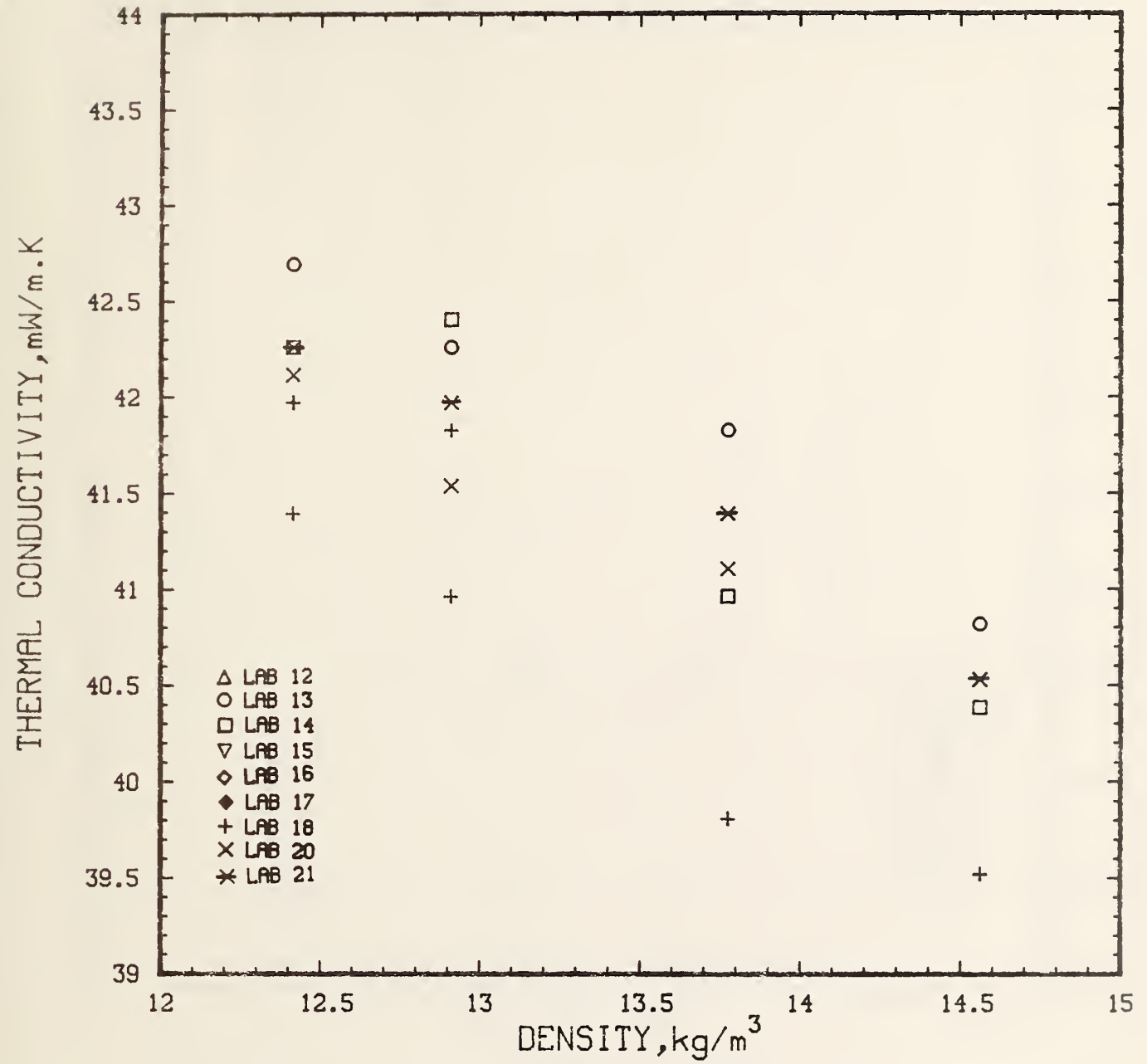

Figure 6.2 Thermal Conductivity versus Density for the 610-254 mm Heat Flow Meter Apparatus from Round Robin I.

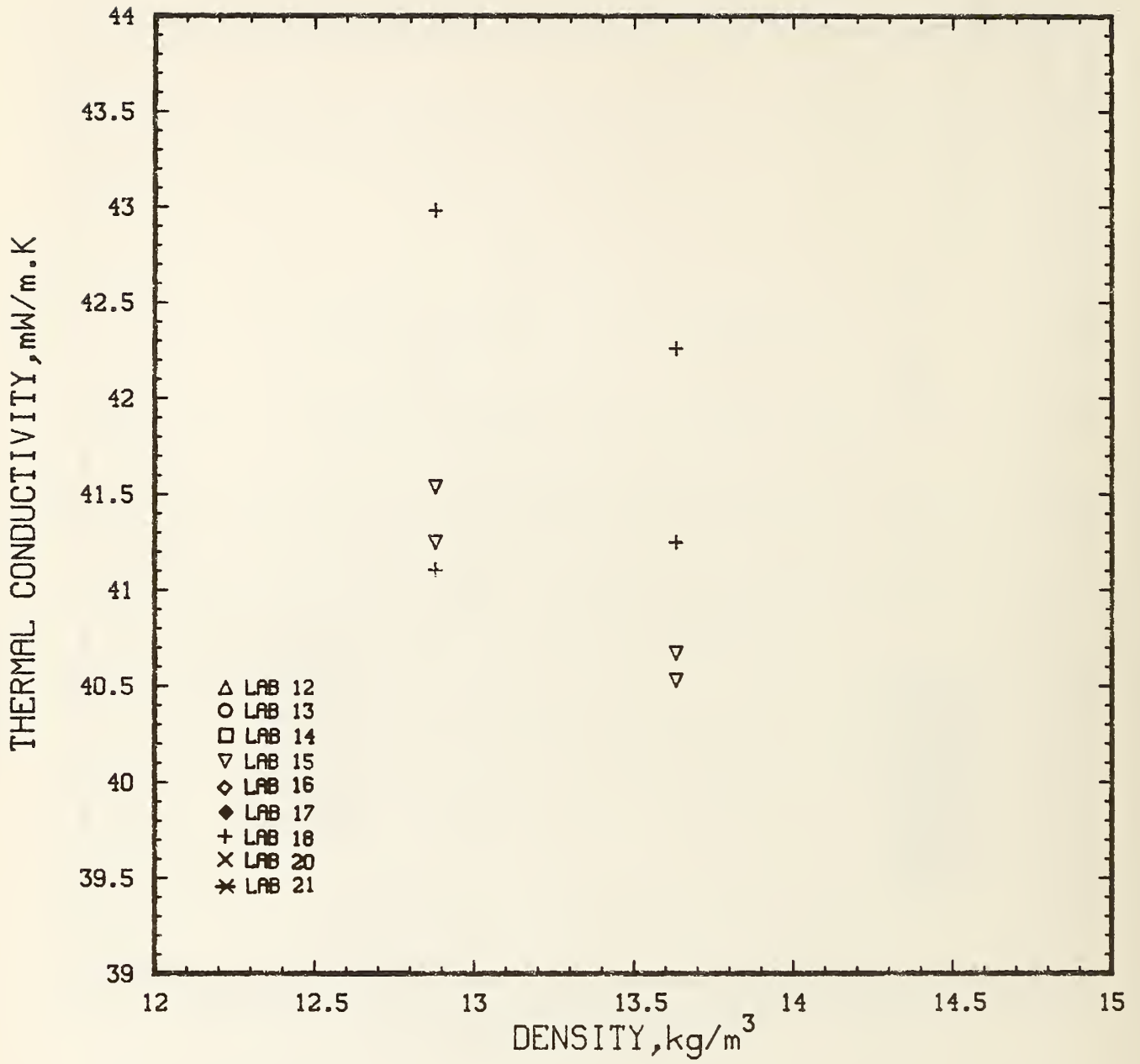

Figure 6.3 Thermal Conductivity versus Density for the Guarded Hot Plate Apparatus from Round Robin I.

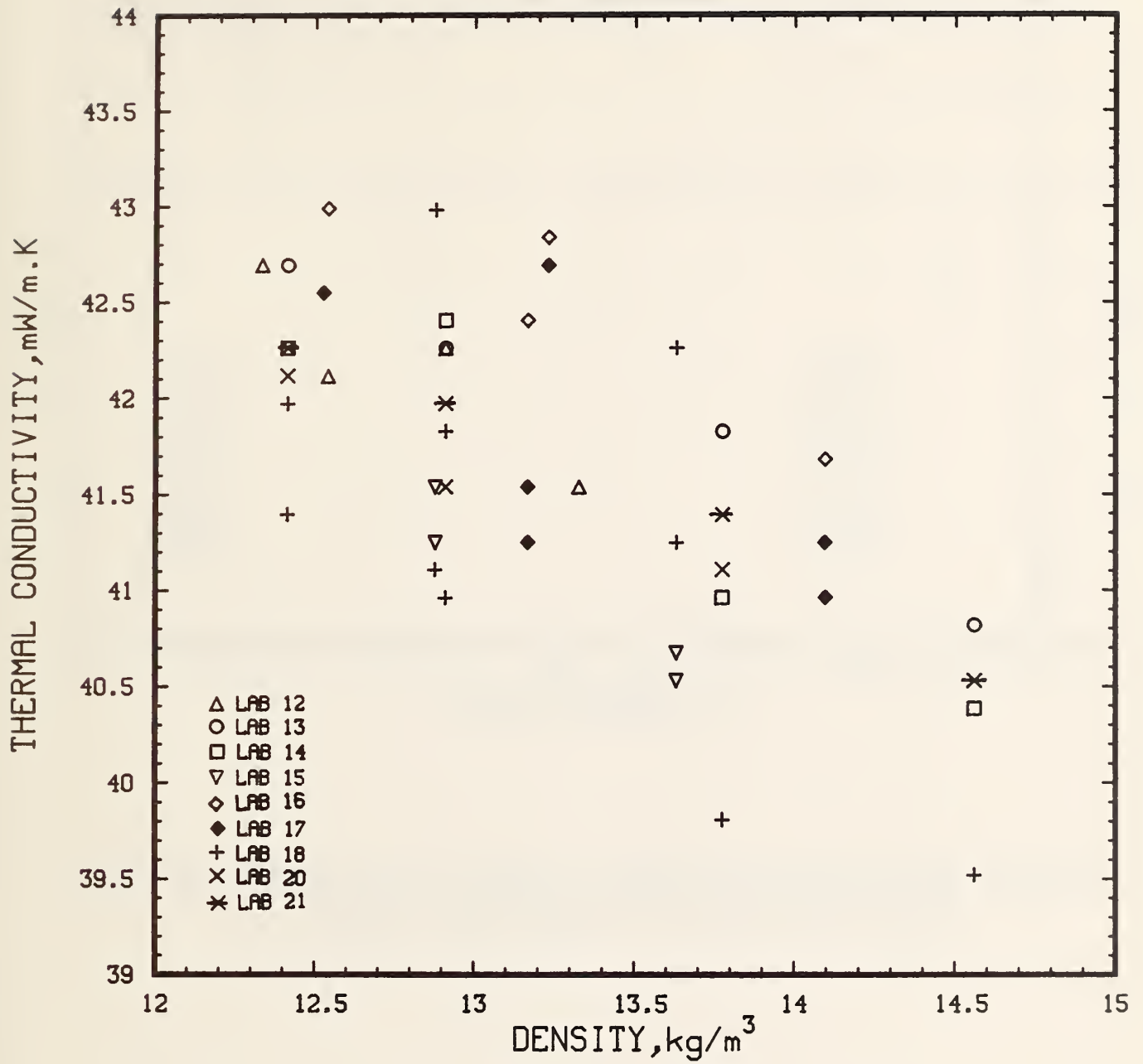

Figure 6.4 Thermal Conductivity versus Density for all of the Data from Round Robin I.

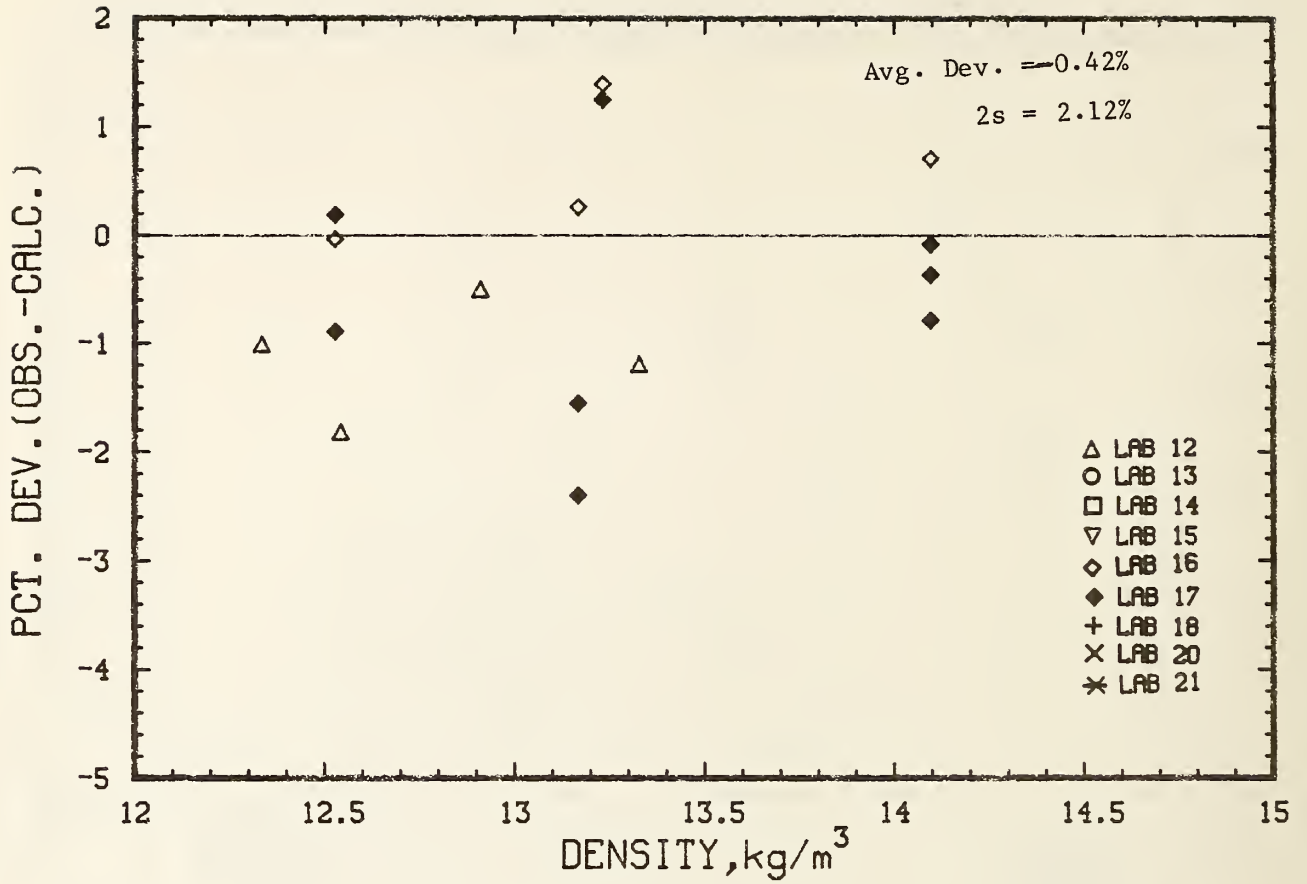

Figure 6.5 Deviations between Thermal Conductivity Data for the 915-406 mm and 915-305 mm Heat Flow Meter Apparatus from Round Robin I and Values Calculated from the Model versus Density.

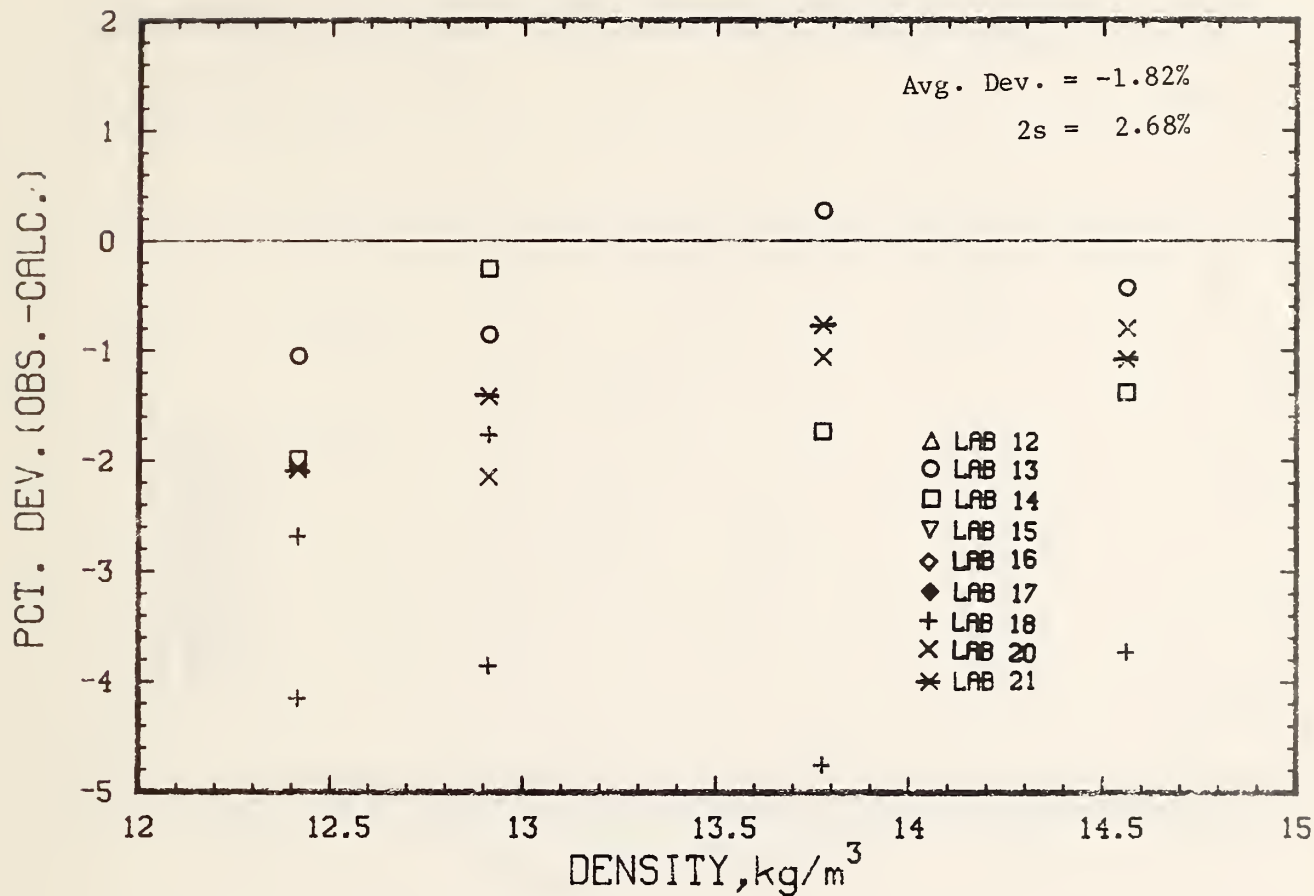

Figure 6.6 Deviations between Thermal Conductivity Data for the 610-254 mm Heat Flow Meter Apparatus from Round Robin I and Values Calculated from the Model versus Density.

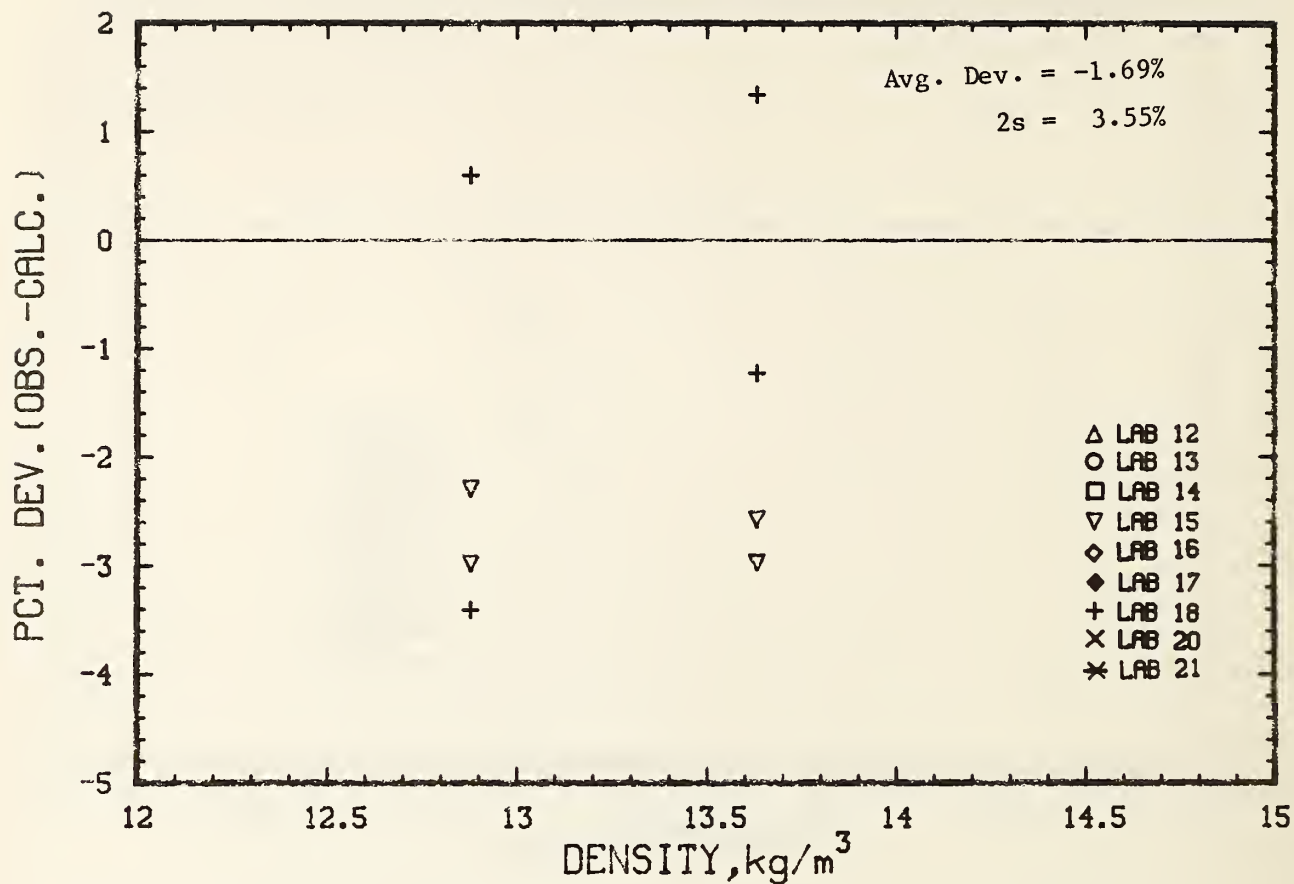

Figure 6.7 Deviations between Thermal Conductivity Data from the Guarded Hot Plate Apparatus from Round Robin I and Values Calculated from the Model versus Density.

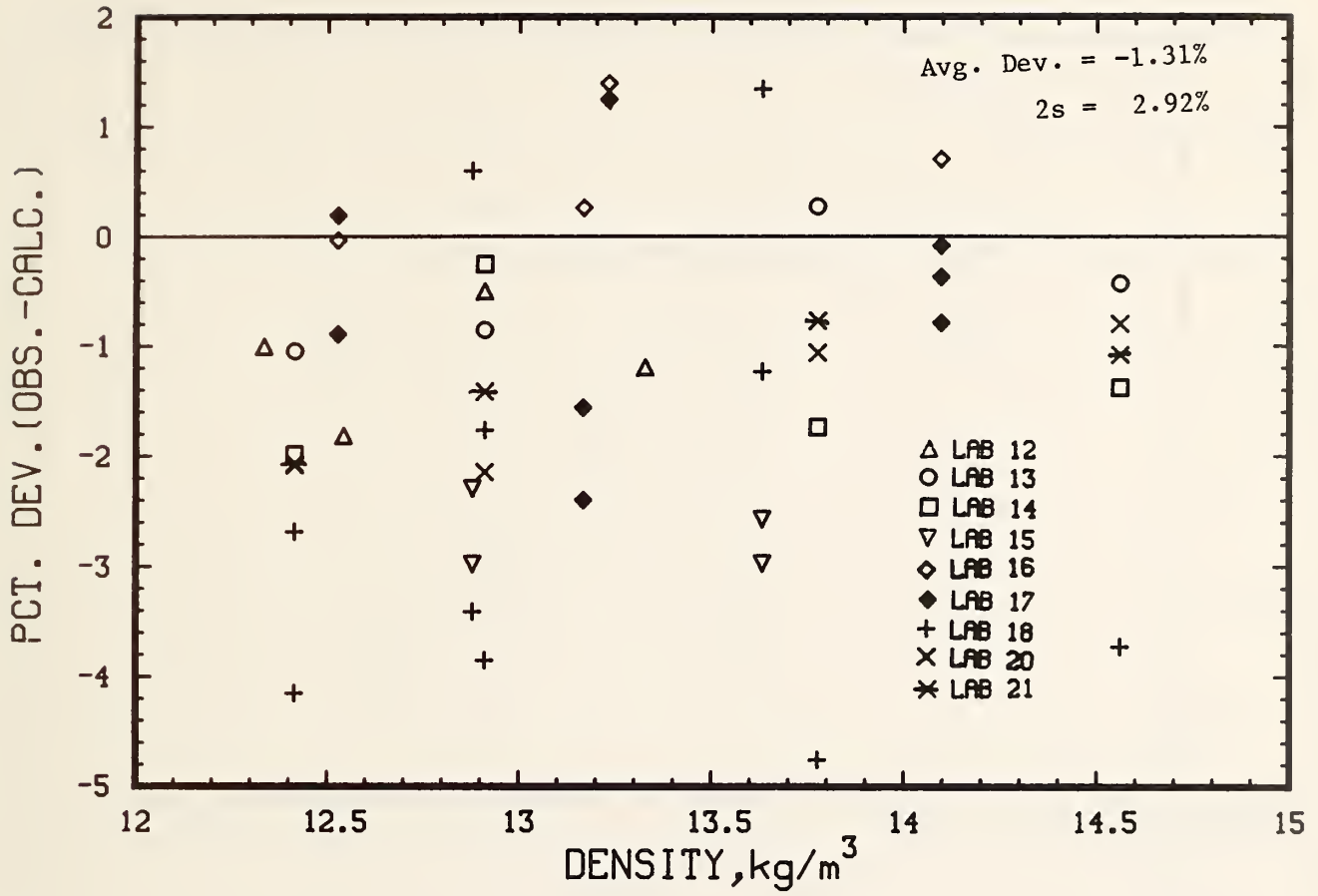

Figure 6.8 Deviations between all Thermal Conductivity Data from Round Robin I and Values Calculated from the Model versus Density.

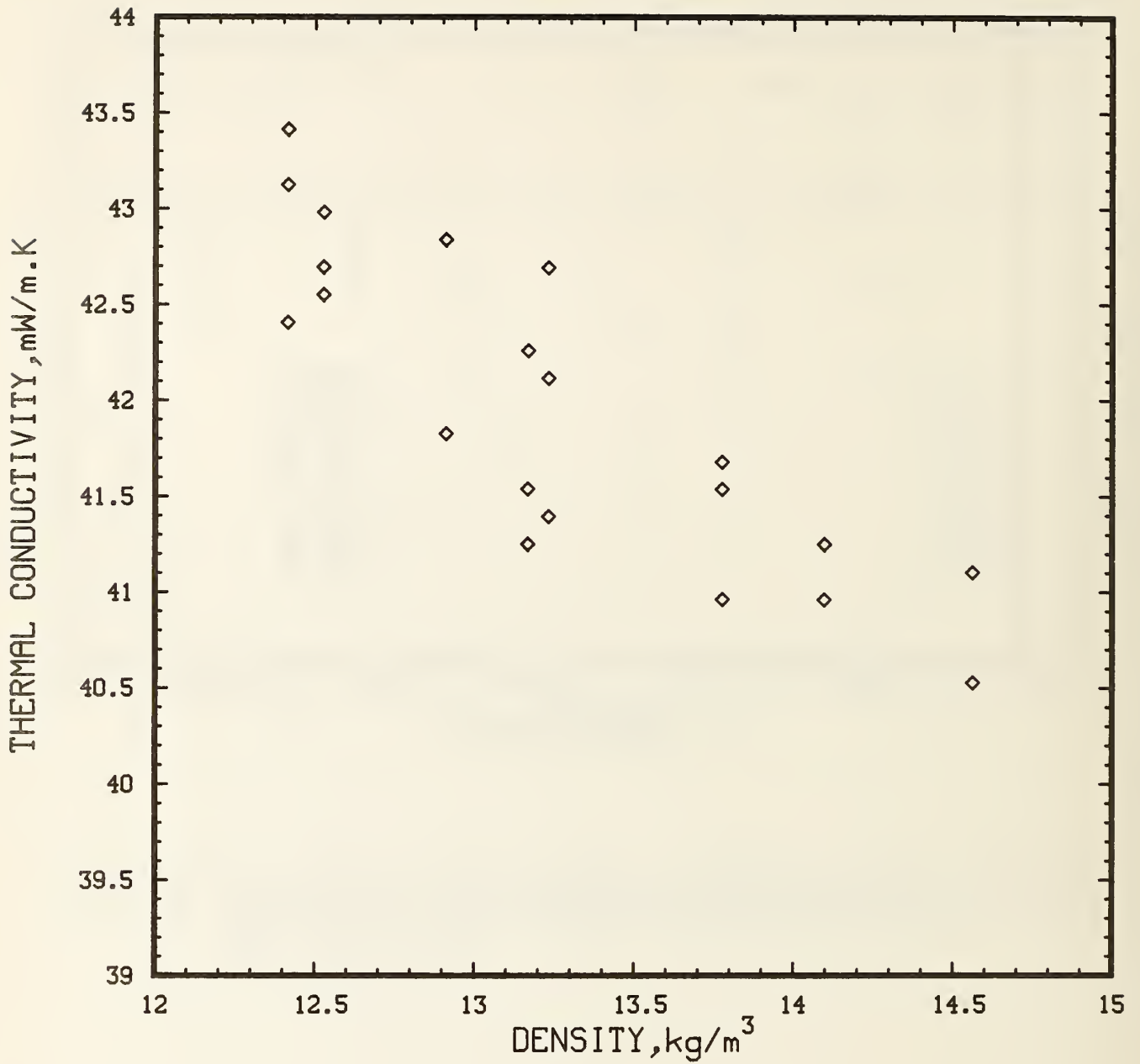

Figure 6.9 Thermal Conductivity versus Density for Control Data taken by Lab 17 for Round Robin I over the period 1976 to 1980.

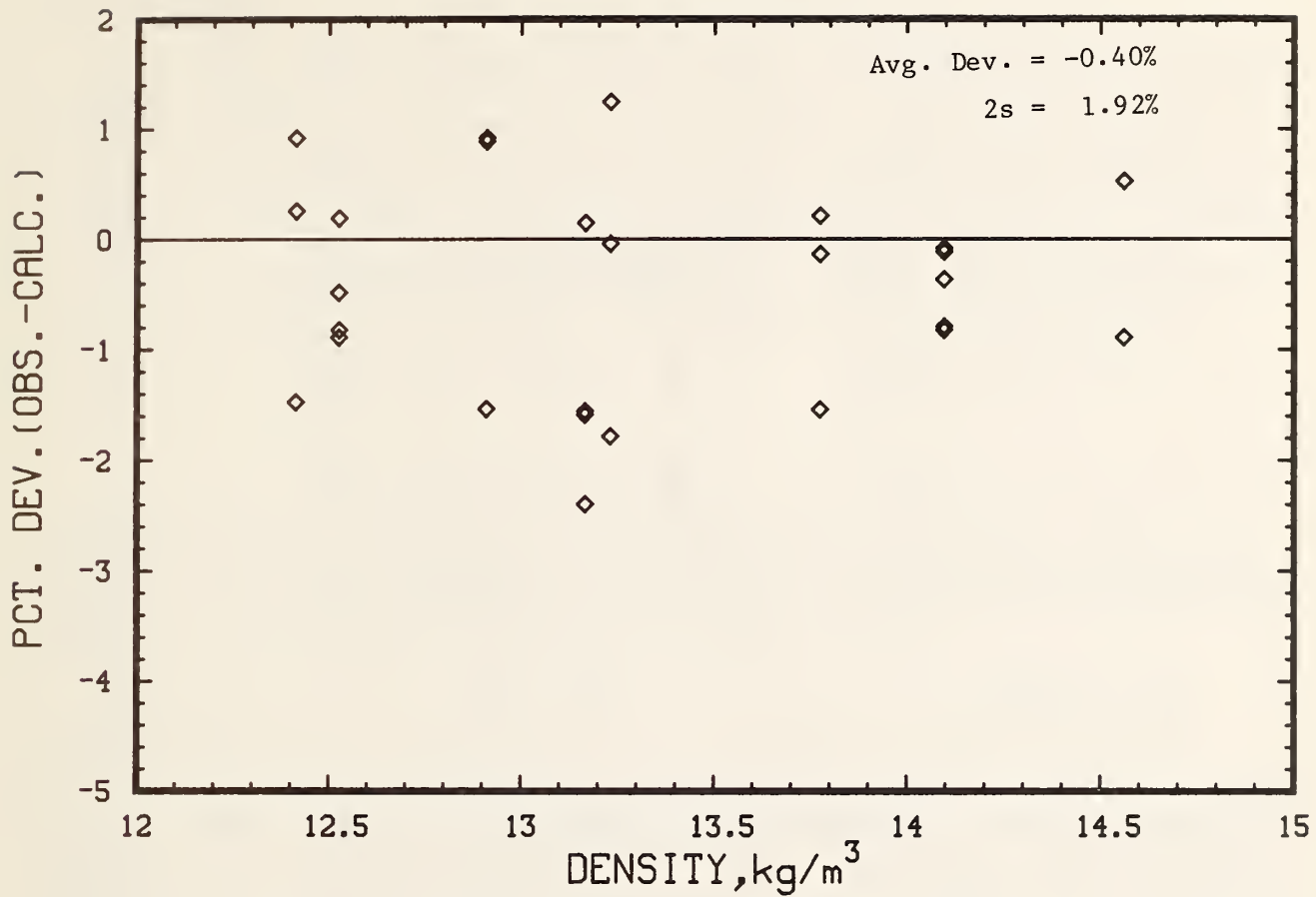

Figure 6.10 Deviations between Control Data from Lab 17 and Values Calculated from the Model versus Density

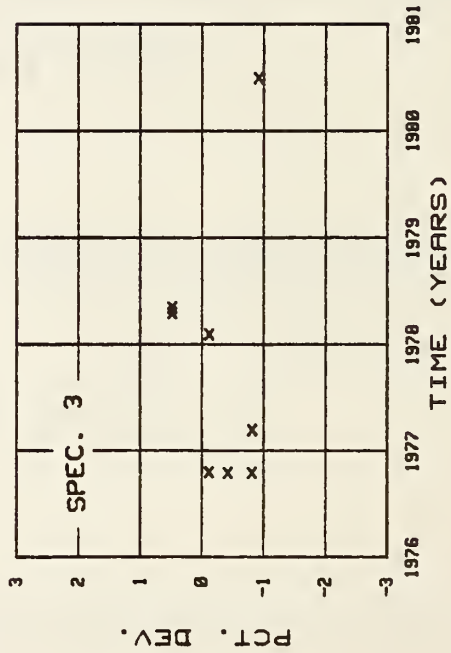
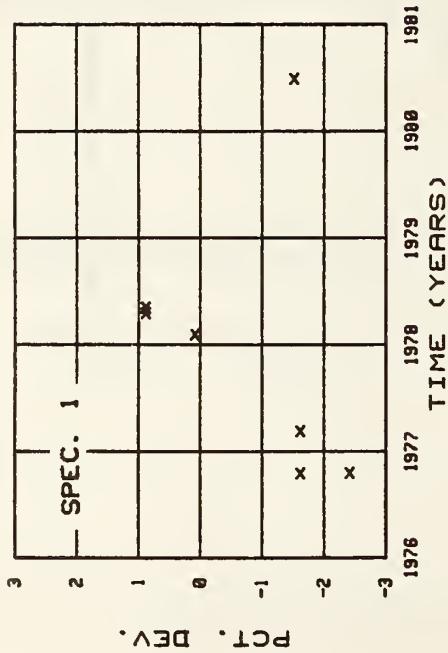
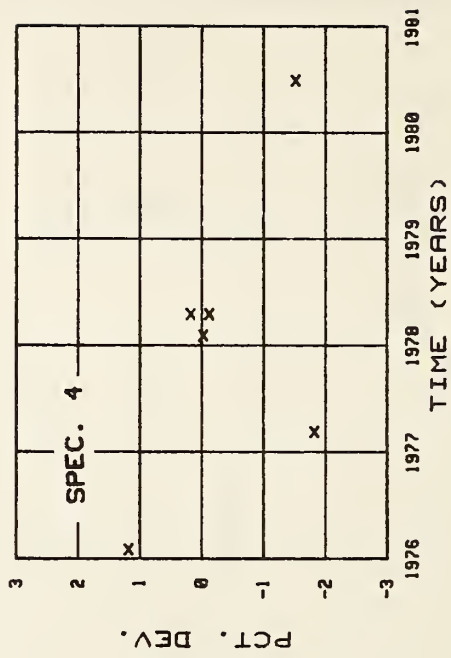
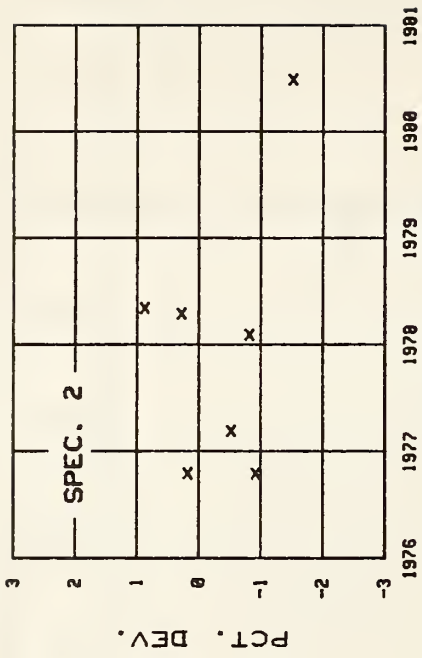

Figure 6.11 Deviations between Control Data from Lab 17 for Round Robin I and Values Calculated from the Model versus Time.

7. ROUND ROBIN II

7.1 Overview

This round robin, started in February 1977, was initiated in order to evaluate the thermal insulation testing community's capability when measuring thermal insulations of low density where the effects of plate emittance can have an influence on the results due to radiative heat transfer. The only reference standard (NBS's SRM-1450) [12] [13] available to evaluate the performance of the equipment is too dense (120-160 kg/m³) to allow the perception of a change in surface plate emittance. While some of the tests, by the originating laboratory, were performed early (June 1974 for the original reference values) and late, at the end of the program (July 1981 and November 1983), the majority of the tests were carried out between February 1977 and May 1979.

The C-16.30 Task Force member consisted solely of C.M. Pelanne-Chairman.

The specimens (appliance insulation) were part of a select group of specimens prepared by Manville Research and Development Center as calibrated reference specimens referenced to similar specimens measured by the National Bureau of Standards, Gaithersburg, MD (NBS Dec. 1974). Further information relating to the reference values has been published [9].

Seven HFM (C518) [2], three GHP (C177) [1] and one reported as a GHP yielding results on single specimens were involved in these measurements.

The majority of the tests were performed at 25 mm (1.0 in) test thickness and 24°C (75°F). Some special tests were performed by participants wishing to evaluate their equipment beyond the scope of the round robin. These data are reported but not incorporated in the analysis. They include tests at temperatures above and below 24°C and tests with and without opaque sheets between layers of insulation (septa).

Tables 7.1 through 7.5 show the results of all of the measurements obtained during the course of this round robin. Further explanation of the tables can be found in the appendix.

7.2 Test Specimens

The test specimens consisted of four pairs of matched 25.4 mm (1.0 in) blankets of appliance insulation. The specimens were circulated to all of the participating laboratories. The nominal densities of the pairs were 11.1, 16.9, 25.5, and 32.9 kg/m³ (0.69, 1.05, 1.59, and 2.07 lb/ft³). The 305×305 mm (12×12 in) test specimens were provided with 610×610 mm (24×24 in) frames of the same material to facilitate testing in larger apparatus. These specimens were referenced to similar specimens measured by the National Bureau of Standards, Gaithersburg, MD over the same density range and at about -18°C (0°F), 24°C (75°F), and 54°C (130°F) mean temperature. More details about this program may be found in a paper presented at the 17th Thermal Conductivity Conference held in Gaithersburg in June 1981, [9].

The densities were determined on the total specimen and, in order to relate the test density to the test area of the apparatus, the specimens were cut and weighed to successively smaller sizes matching the test areas. Thus for this series of tests seventy six individual density determinations were made. The details about these measurements are given in Table 13.5 of the appendix.

7.3 Test Equipment

Eleven apparatus, seven HFM's, three GHP's and one plate stated to be a GHP (the results were reported for individual specimens), were involved in this round robin. These were as follows:

Apparatus type	Number	Overall size	Test area
Heat flow meter	3	610×610 mm (24×24 in)	254×254 mm (10×10 in)
" " "	1	406×406 mm (16×16 in)	203×203 mm (8× 8 in)
" " "	1	305×305 mm (12×12 in)	152×152 mm (6× 6 in)
" " "	2	305×305 mm (12×12 in)	102×102 mm (4× 4 in)
Guarded hot plate	1	610×610 mm (24×24 in)	305×305 mm (12×12 in)
" " "	1	457×457 mm (18×18 in)	305×305 mm (12×12 in)
" " "	1	305×305 mm (12×12 in)	152×152 mm (6× 6 in)
G. H. P. ?	1	?	?

7.4 Results

The apparent thermal conductivity data resulting from the main part of RR II, that is, the test results obtained at 24°C (75°F) mean temperature and 25.4 mm (1.0 in) test thickness except for the data from laboratory 19 that were taken at 15.6°C (60°F) mean temperature, are plotted in Figures 7.1, 7.2, and 7.3. The data pertaining to the tests performed at different temperatures, different thicknesses and with or without septa are listed in Table 7.5 and plotted in Figure 7.4. Further details on the tests with and without septa performed during the course of this round robin can be found in an earlier paper [14].

The HFM data (37 points) are shown in Figure 7.1, the "GHP" data (10 points as pairs and 8 points for individuals) are shown in Figure 7.2 and the composite of all of the RR II data (total 55 points) are shown in Figure 7.3.

The deviations of the RR II data from the model are shown in Figures 7.5 through 7.8 in the same sequence as Figures 7.1 to 7.4. The deviation (observed - calculated) are also listed in the last column of Tables 7.1 through 7.5.

The average deviation from the model and the 2s value for each data subset are given in each deviation plot.

Figure 7.5 shows the 2s value for the HFM's is 1.73%, which is about the same as for the RR I data. Figure 7.6 shows the GHP data from laboratory 15 at about the same level as the major part of the HFM data. The data from laboratory 19 however is considerably lower (10%) than the mean value for both round robins. Figure 7.7 shows the composite of all of the data. The model values are 0.74% larger than the mean experimental values for RR II (disregarding the data from laboratory 19). Again the interlaboratory spread is larger than the intralaboratory spread.

These results do not indicate any effect resulting from plate emittance variations. This would be reflected in a greater spread in the data at the lowest densities. It should be noted that the data from laboratory 13 (Table 5.2) and laboratory 18 (Table 7.5) cover a range of temperature from 256 to 332 K and they agree to within $\pm 2\%$. Since the three round robins are closely related, the discussion of the significance of these results is relegated to section 9.

Any changes in the thermal resistance of the specimens over and beyond the extent of the round robin can be verified through the tests performed by laboratory 17. In Table 7.4, the test data given for measurement with apparatus H1206 cover tests on the same apparatus from June 1974 to November 1983, (6/74, 2/77, 5/79, 7/81, 11/83). Similar tests performed on 1/78 and 3/78 using apparatus H2410 are listed in Table 7.3. All of these results are plotted in Figures 7.9 and 7.10. The results from the H1206 apparatus vary by no more than $\pm 1\%$ except in the case of specimen 5 for which indication of damage is reported. The deviations for the H1206 results are plotted versus time in Figures 7.11 and 7.12. No systematic trend is observed other than for specimen 5. The apparent thermal conductivity of specimen 5 increased by 3.8%. No further round robin tests were performed after the damage was observed, the last tests are dated 11/79, except for the verification test. This indicates that most of the variation in the test results is related to the testing and not to changes in the specimens.

Table 7.1 ASTM C-16.30/MIMA Round Robins. Data from Heat Flow Meter Apparatus for Round Robin II.

RR NO.	LAB NO.	DATE M Y	EQUIP TYPE	TEST COND.	SPEC. NO.	THICK. cm	DENS. kg/m ³	HOT TEMP	COLD TEMP	MEAN TEMP	k mW/(m ² ·K)	FOOT- NOTES	PCT
II 11	11	1278	H1204	105	1	2.54	10.88	308.3	286.2	297.2	44.6		-0.5
II 11	11	1078	H1204	105	5	2.54	10.75	308.1	285.8	296.9	44.1		-1.7
II 11	11	1078	H1204	110	2	2.54	18.23	308.2	285.9	297.0	37.9		-1.2
II 11	11	1078	H1204	110	6	2.54	17.28	308.0	285.9	297.0	38.1		-2.1
II 11	11	1278	H1204	115	3	2.54	27.01	308.3	286.0	297.1	35.0		-0.7
II 11	11	1078	H1204	115	7	2.54	26.01	308.2	285.9	297.0	35.5		-0.2
II 11	11	1278	H1204	120	4	2.54	33.45	308.2	286.0	297.1	34.3		0.7
II 11	11	1078	H1204	120	8	2.54	33.11	308.2	286.1	297.1	34.5		0.9
II 12	12	0577	H1608	205	15	2.54	10.78	308.2	285.9	297.0	44.6	P	-0.7
II 12	12	0577	H1608	210	26	2.54	17.33	308.2	285.9	297.0	38.8	P	-0.2
II 12	12	0577	H1608	215	37	2.54	25.82	308.2	285.9	297.0	35.5	P	-0.3
II 12	12	0577	H1608	220	48	2.54	32.76	308.2	285.9	297.0	34.0	P	-0.5
II 14	14	0478	H2410	105	1	2.54	10.97	308.8	283.7	296.3	44.9		1.0
II 14	14	0478	H2410	105	5	2.54	10.70	308.8	283.8	296.3	44.6		-0.5
II 14	14	0478	H2410	110	2	2.54	16.64	309.3	283.7	296.5	38.8		-0.9
II 14	14	0478	H2410	110	6	2.54	17.12	309.3	283.7	296.5	38.5		-0.9
II 14	14	0478	H2410	115	3	2.54	25.69	309.5	283.5	296.5	35.2		-0.9
II 14	14	0478	H2410	115	7	2.54	25.50	309.4	283.6	296.5	35.3		-0.7
II 14	14	0478	H2410	120	4	2.54	32.90	309.5	283.6	296.5	33.2		-2.8
II 14	14	0478	H2410	120	8	2.54	32.50	309.5	283.6	296.6	34.0		-0.4
II 17	17	0277	H1206	105	1	2.54	10.59	310.9	283.2	297.0	44.6		-1.3
II 17	17	0277	H1206	105	5	2.54	10.76	310.9	283.2	297.0	44.4		-1.1
II 17	17	0277	H1206	110	2	2.54	17.59	310.9	283.2	297.0	38.2		-1.3
II 17	17	0277	H1206	110	6	2.54	17.84	310.9	283.2	297.0	38.4		-0.6
II 17	17	0277	H1206	115	3	2.54	25.90	310.9	283.2	297.0	35.3		-0.7
II 17	17	0277	H1206	115	7	2.54	24.57	310.9	283.2	297.0	35.3		-1.7
II 17	17	0277	H1206	120	4	2.54	32.52	310.9	283.2	297.0	34.0		-0.6
II 17	17	0277	H1206	120	8	2.54	32.40	310.9	283.2	297.0	34.0		-0.6
II 18	18	0377	H2410	105	1	2.54	10.97	308.3	283.4	295.9	44.1		-0.3
II 18	18	0377	H2410	105	5	2.54	10.70	308.4	283.3	295.9	44.4	P	-0.6
II 18	18	0377	H2410	110	2	2.54	16.64	308.4	283.4	295.9	38.8		-0.6
II 18	18	0377	H2410	115	7	2.54	25.50	308.4	283.4	295.9	35.0		-1.2
II 18	18	0377	H2410	120	8	2.54	32.50	308.5	283.4	295.9	33.6		-1.4
II 18	18	0377	H1204	105	1	2.54	10.88	305.2	286.1	295.7	44.7		0.8
II 18	18	0377	H1204	110	2	2.54	18.23	305.4	286.4	295.9	38.5		1.0
II 18	18	0377	H1204	115	7	2.54	26.01	305.4	286.0	295.7	35.0		-0.7
II 18	18	0377	H1204	120	8	2.54	33.11	305.4	285.9	295.7	34.3		1.2

p: Specimens tested in pairs. Given values are the average.

Table 7.2 ASTM C-16.30/MIMA Round Robins. Data from Guarded Hot Plate Apparatus for Round Robin II.

RR NO.	LAB NO.	DATE M Y	EQUIP TYPE	TEST COND.	SPEC. NO.	THICK. cm	DENS. kg/m ³	HOT TEMP	COLD TEMP	MEAN TEMP	k mW/(m ² ·K)	FOOT-NOTES	PCT
II 15	15	0877	G1206	205	15	2.54	10.67	308.1	285.9	297.0	44.6		-1.0
II 15	15	0877	G1206	210	26	2.54	17.75	308.2	285.9	297.0	38.2		-1.1
II 15	15	0877	G1206	215	37	2.54	25.24	308.2	285.9	297.0	35.2		-1.6
II 15	15	0877	G1206	220	48	2.54	32.45	308.3	285.9	297.1	33.9		-1.1
II 15	15	0877	G1812	205	15	2.54	10.73	308.3	286.0	297.1	44.3		-1.6
II 15	15	0877	G1812	210	26	2.54	16.72	308.2	286.0	297.1	38.7		-1.5
II 15	15	0877	G1812	215	37	2.54	25.39	308.0	286.0	297.0	35.2		-1.4
II 15	15	0877	G1812	220	48	2.54	32.52	308.1	286.0	297.0	33.9		-1.0
II 15	15	0877	G2412	205	15	2.54	10.73	308.3	286.0	297.1	44.3		-1.5
II 15	15	0877	G2412	220	48	2.54	32.61	308.2	285.9	297.0	33.9		-1.0
II 19	19	1078	G	105	1	2.54	10.81	299.8	277.6	288.7	39.1	g h	-9.0
II 19	19	1078	G	105	5	2.54	10.81	299.8	277.6	288.7	38.2	g h	-11.5
II 19	19	1078	G	110	2	2.54	17.30	299.8	277.6	288.7	33.2	g h	-12.1
II 19	19	1078	G	110	6	2.54	17.30	299.8	277.6	288.7	33.6	g h	-10.6
II 19	19	1078	G	115	3	2.54	25.47	299.8	277.6	288.7	30.3	g h	-13.0
II 19	19	1078	G	115	7	2.54	25.47	299.8	277.6	288.7	30.4	g h	-12.5
II 19	19	1078	G	120	4	2.54	32.60	299.8	277.6	288.7	29.6	g h	-11.3
II 19	19	1078	G	120	8	2.54	32.60	299.8	277.6	288.7	29.7	g h	-10.7

g: No apparatus size provide.

h: Only mean temperature given, hot and cold assumed.

Table 7.3 ASTM C-16.30/MIMA Round Robins. Data from Lab 17 over the Time Period from 1974 to 1983 for Round Robin II (610-254 mm plates).

RR NO.	LAB NO.	DATE M Y	EQUIP TYPE	TEST COND.	SPEC. NO.	THICK. cm	DENS. kg/m ³	HOT TEMP	COLD TEMP	MEAN TEMP	k mw/(m ² ·K)	FOOT-NOTES	PCT
II 17	17	0178	H2410	105	1	2.54	10.97	310.9	283.2	297.0	43.8	cm	-1.7
II 17	17	0178	H2410	105	1	2.54	10.97	310.9	283.2	297.0	43.7	cm	-2.0
II 17	17	0178	H2410	105	5	2.54	10.70	310.9	283.2	297.0	44.0	cm	-2.3
II 17	17	0178	H2410	105	5	2.54	10.70	310.9	283.2	297.0	44.0	cm	-2.3
II 17	17	0178	H2410	110	2	2.54	16.64	310.9	283.2	297.0	38.5	cm	-2.0
II 17	17	0178	H2410	110	2	2.54	16.64	310.9	283.2	297.0	38.4	cm	-2.4
II 17	17	0178	H2410	110	6	2.54	17.12	310.9	283.2	297.0	38.2	cm	-2.0
II 17	17	0178	H2410	110	6	2.54	17.12	310.9	283.2	297.0	38.2	cm	-2.0
II 17	17	0178	H2410	115	3	2.54	25.69	310.9	283.2	297.0	35.0	cm	-1.6
II 17	17	0178	H2410	115	3	2.54	25.69	310.9	283.2	297.0	34.9	cm	-2.1
II 17	17	0178	H2410	115	7	2.54	25.50	310.9	283.2	297.0	34.9	cm	-2.2
II 17	17	0178	H2410	115	7	2.54	25.50	310.9	283.2	297.0	34.9	cm	-2.2
II 17	17	0178	H2410	120	4	2.54	32.90	310.9	283.2	297.0	33.6	cm	-1.7
II 17	17	0178	H2410	120	4	2.54	32.90	310.9	283.2	297.0	33.6	cm	-1.7
II 17	17	0178	H2410	120	8	2.54	32.50	310.9	283.2	297.0	33.5	cm	-2.3
II 17	17	0178	H2410	120	8	2.54	32.50	310.9	283.2	297.0	33.5	cm	-2.3
II 17	17	0378	H2410	105	1	2.54	10.97	310.9	283.2	297.0	44.3	cu	-0.7
II 17	17	0378	H2410	105	5	2.54	10.70	310.9	283.2	297.0	44.4	cu	-1.3
II 17	17	0378	H2410	110	2	2.54	16.64	310.9	283.2	297.0	38.8	cu	-1.3
II 17	17	0378	H2410	110	6	2.54	17.12	310.9	283.2	297.0	38.5	cu	-1.3
II 17	17	0378	H2410	115	3	2.54	25.69	310.9	283.2	297.0	35.3	cu	-0.8
II 17	17	0378	H2410	115	7	2.54	25.50	310.9	283.2	297.0	35.2	cu	-1.4
II 17	17	0378	H2410	120	4	2.54	32.90	310.9	283.2	297.0	33.9	cu	-0.8
II 17	17	0378	H2410	120	8	2.54	32.50	310.9	283.2	297.0	33.7	cu	-1.5

cm: Heat meter constant and thickness calibration supplied by equipment manufacturer.
cu: Heat meter constant and thickness calibration established by user.

Table 7.4 ASTM C-16.30/MIMA Round Robins. Data from Lab 17 over the Time Period from 1974 to 1983 for Round Robin II (305-152 mm plates).

RR NO.	LAB NO.	DATE M Y	EQUIP TYPE	TEST COND.	SPEC. NO.	THICK. cm	DENS. kg/m ³	HOT TEMP	COLD TEMP	MEAN TEMP	k mW/(m ² ·K)	FOOT-NOTES	PCT
II 17	17	0674	H1206	105	1	2.54	10.59	310.9	283.2	297.0	45.0	b	-0.3
II 17	17	0674	H1206	105	1	2.54	10.59	310.9	283.2	297.0	44.9	b	-0.7
II 17	17	0674	H1206	105	5	2.54	10.76	310.9	283.2	297.0	44.7	b	-0.4
II 17	17	0674	H1206	105	5	2.54	10.76	310.9	283.2	297.0	44.7	b	-0.4
II 17	17	0674	H1206	110	2	2.54	17.59	310.9	283.2	297.0	38.4	b	-0.9
II 17	17	0674	H1206	110	2	2.54	17.59	310.9	283.2	297.0	38.4	b	-0.9
II 17	17	0674	H1206	110	6	2.54	17.84	310.9	283.2	297.0	38.5	b	-0.2
II 17	17	0674	H1206	110	6	2.54	17.84	310.9	283.2	297.0	38.7	b	0.2
II 17	17	0674	H1206	115	3	2.54	25.90	310.9	283.2	297.0	35.5	b	-0.2
II 17	17	0674	H1206	115	3	2.54	25.90	310.9	283.2	297.0	35.5	b	-0.2
II 17	17	0674	H1206	115	3	2.54	25.90	310.9	283.2	297.0	35.5	b	-0.2
II 17	17	0674	H1206	115	7	2.54	24.57	310.9	283.2	297.0	35.5	b	-1.3
II 17	17	0674	H1206	115	7	2.54	24.57	310.9	283.2	297.0	35.5	b	-1.3
II 17	17	0674	H1206	120	4	2.54	32.52	310.9	283.2	297.0	34.2	b	-0.2
II 17	17	0674	H1206	120	4	2.54	32.52	310.9	283.2	297.0	34.2	b	-0.2
II 17	17	0674	H1206	120	8	2.54	32.40	310.9	283.2	297.0	34.2	b	-0.2
II 17	17	0674	H1206	120	8	2.54	32.40	310.9	283.2	297.0	34.2	b	-0.2
II 17	17	0579	H1206	105	1	2.54	10.59	310.9	283.2	297.0	34.0	b	-0.6
II 17	17	0579	H1206	105	5	2.54	10.76	310.9	283.2	297.0	45.1	0.6	0.6
II 17	17	0579	H1206	110	2	2.54	17.59	310.9	283.2	297.0	38.8	0.2	0.2
II 17	17	0579	H1206	110	6	2.54	17.84	310.9	283.2	297.0	38.7	0.2	0.2
II 17	17	0579	H1206	115	3	2.54	25.90	310.9	283.2	297.0	35.5	0.2	0.2
II 17	17	0579	H1206	115	7	2.54	24.57	310.9	283.2	297.0	35.8	-0.4	-0.4
II 17	17	0579	H1206	120	4	2.54	32.52	310.9	283.2	297.0	34.3	0.3	0.3
II 17	17	0579	H1206	120	8	2.54	32.40	310.9	382.2	297.0	34.2	b	-0.2
II 17	17	0781	H1206	105	1	2.54	10.59	310.9	283.2	297.0	44.7	-1.0	-1.0
II 17	17	0781	H1206	105	5	2.54	10.76	310.9	283.2	297.0	46.3	3.0	3.0
II 17	17	0781	H1206	110	2	2.54	17.59	310.9	283.2	297.0	38.4	-0.9	-0.9
II 17	17	0781	H1206	110	6	2.54	17.84	310.9	283.2	297.0	38.4	-0.6	-0.6
II 17	17	0781	H1206	115	3	2.54	25.90	310.9	283.2	297.0	35.5	-0.2	-0.2
II 17	17	0781	H1206	115	7	2.54	24.57	310.9	283.2	297.0	35.5	-1.3	-1.3
II 17	17	0781	H1206	120	4	2.54	32.52	310.9	283.2	297.0	34.2	-0.2	-0.2
II 17	17	0781	H1206	120	8	2.54	32.40	310.9	283.2	297.0	34.0	-0.6	-0.6
II 17	17	1183	H1206	105	1	2.54	10.59	310.7	283.3	297.0	44.9	-0.6	-0.6
II 17	17	1183	H1206	105	5	2.54	10.76	310.7	283.3	297.0	46.6	3.7	3.7
II 17	17	1183	H1206	105	5	2.54	10.76	310.7	283.3	297.0	46.6	3.6	3.6
II 17	17	1183	H1206	110	2	2.54	17.59	310.8	283.2	297.0	38.7	-0.2	-0.2
II 17	17	1183	H1206	110	6	2.54	17.84	310.8	283.3	297.0	38.5	-0.2	-0.2
II 17	17	1183	H1206	115	3	2.54	25.90	310.9	283.2	297.0	35.5	-0.2	-0.2
II 17	17	1183	H1206	115	7	2.54	24.57	310.9	283.2	297.0	35.6	-0.8	-0.8
II 17	17	1183	H1206	120	4	2.54	32.52	310.9	283.3	297.1	34.5	0.7	0.7
II 17	17	1183	H1206	120	8	2.54	32.40	310.9	283.3	297.1	34.2	-0.2	-0.2

b: Reference values for the specimens based on NBS data.
 cd: Specimen center test area damaged.

Table 7.5 ASTM C-16.30/MIMA Round Robins. Special Tests with Thickness and Temperature as Variables (with and without septum).

RR NO.	LAB NO.	DATE M Y	EQUIP TYPE	TEST COND.	SPEC. NO.	THICK. cm	DENS. kg/m ³	HOT TEMP	COLD TEMP	MEAN TEMP	k _s mW/(ft ² ·K)	FOOT- NOTES	PCT
II 11	11	1178	H1204	305	15	5.08	10.81	308.3	286.1	297.2	45.1	e	-0.5
II 11	11	1178	H1204	405	15	5.08	10.81	308.3	285.8	297.0	45.1	f	-0.5
II 11	11	1178	H1204	310	26	5.08	17.75	308.2	286.1	297.2	38.5	e	-0.9
II 11	11	1178	H1204	410	26	5.08	17.75	308.3	285.8	297.0	38.1	f	-2.0
II 11	11	1178	H1204	315	37	5.08	26.51	308.2	286.0	297.1	35.8	e	0.7
II 11	11	1178	H1204	415	37	5.08	26.51	308.3	286.1	297.2	35.6	f	0.2
II 11	11	1178	H1204	320	48	5.08	33.29	308.0	286.0	297.0	34.2	e	0.0
II 11	11	1178	H1204	420	48	5.08	33.29	308.2	285.9	297.1	34.0	f	-0.4
II 14	14	0478	H2410	305	15	5.08	10.83	310.3	233.4	296.8	46.0	e	1.6
II 14	14	0478	H2410	310	26	5.08	16.88	310.5	283.3	296.9	39.8	e	1.2
II 14	14	0478	H2410	315	37	5.08	25.60	310.7	283.4	297.0	36.2	e	1.3
II 14	14	0478	H2410	320	48	5.08	32.71	310.7	283.3	297.0	34.6	e	1.0
II 17	17	0378	H2410	305	15	5.13	10.83	310.9	283.2	297.0	45.6	e cu	0.5
II 17	17	0378	H2410	310	15	5.13	10.83	310.9	283.2	297.0	45.4	e cu	0.2
II 17	17	0378	H2410	315	26	5.13	16.88	310.9	283.2	297.0	39.5	e cu	0.4
II 17	17	0378	H2410	320	37	5.13	25.60	310.9	283.2	297.0	35.6	e cu	-0.3
II 17	17	0378	H2410	315	37	5.13	25.60	310.9	283.2	297.0	35.9	e cu	0.5
II 17	17	0378	H2410	320	48	5.13	32.71	310.9	283.2	297.0	34.3	e cu	0.2
II 17	17	0378	H2410	310	48	5.13	32.71	310.9	283.2	297.0	34.3	e cu	0.2
II 18	18	0377	H2410	305	15	5.08	10.83	308.9	283.3	296.1	45.6	e	1.1
II 18	18	0377	H2410	310	26	5.08	16.88	309.2	283.3	296.2	39.4	e	0.5
II 18	18	0377	H2410	315	37	5.08	25.60	311.0	283.3	297.2	35.8	e	0.0
II 18	18	0377	H2410	320	48	5.08	32.71	311.3	283.3	297.3	34.0	e	-0.8
II 18	18	0377	H1204	105	1	2.54	10.88	277.2	257.3	267.2	37.6	t-r	1.2
II 18	18	0377	H1204	105	1	2.54	10.88	305.2	286.1	295.7	44.7	t-r	0.8
II 18	18	0377	H1204	105	1	2.54	10.88	342.1	322.0	332.1	56.0	t-r	2.0
II 18	18	0377	H1204	110	2	2.54	18.23	278.0	258.2	268.1	33.3	t-r	1.7
II 18	18	0377	H1204	110	2	2.54	18.23	305.4	286.4	295.9	38.5	t-r	1.0
II 18	18	0377	H1204	110	2	2.54	18.23	342.2	322.2	332.2	46.7	t-r	1.7
II 18	18	0377	H1204	115	7	2.54	26.01	278.2	257.9	268.0	30.4	t-r	-0.8
II 18	18	0377	H1204	115	7	2.54	26.01	305.4	286.0	295.7	35.0	t-r	-0.7
II 18	18	0377	H1204	115	7	2.54	26.01	342.3	321.4	331.9	41.0	t-r	-2.2
II 18	18	0377	H1204	120	8	2.54	33.11	278.1	258.3	268.2	30.0	t-r	1.0
II 18	18	0377	H1204	120	8	2.54	33.11	305.4	285.9	295.7	34.3	t-r	1.2
II 18	18	0377	H1204	120	8	2.54	33.11	342.3	322.0	332.2	40.0	t-r	0.0

e: Two specimens stacked to 5.08 cm, tested without septum.

f: Two specimens stacked to 5.08 cm, tested with septum.

t-r: Specimens tested over a broader temperature range.

cu: Heat meter constant established by user.

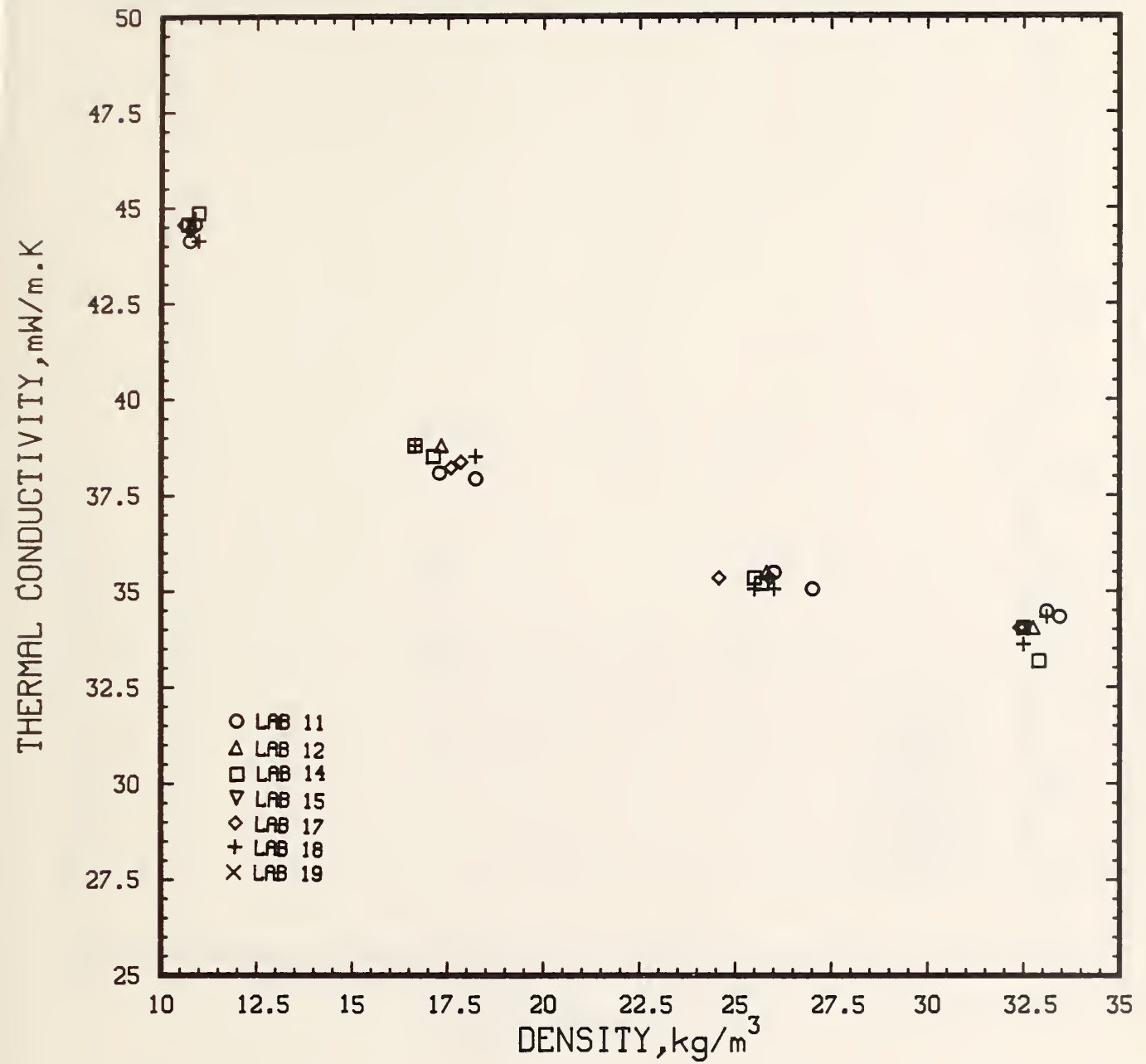

Figure 7.1 Thermal Conductivity versus Density for Heat Flow Meter Apparatus from Round Robin II.

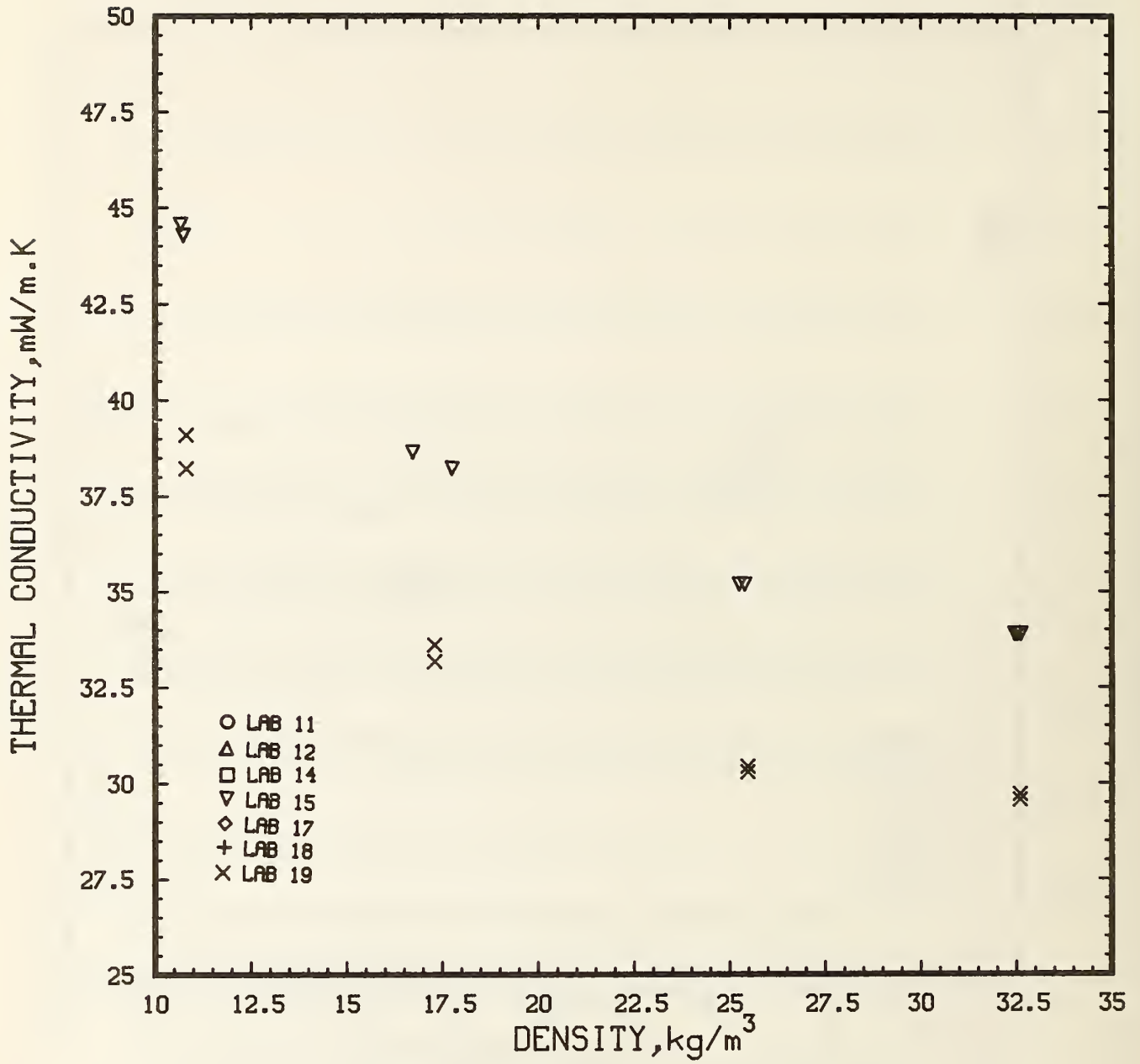

Figure 7.2 Thermal Conductivity versus Density for Guarded Hot Plate Apparatus from Round Robin II.

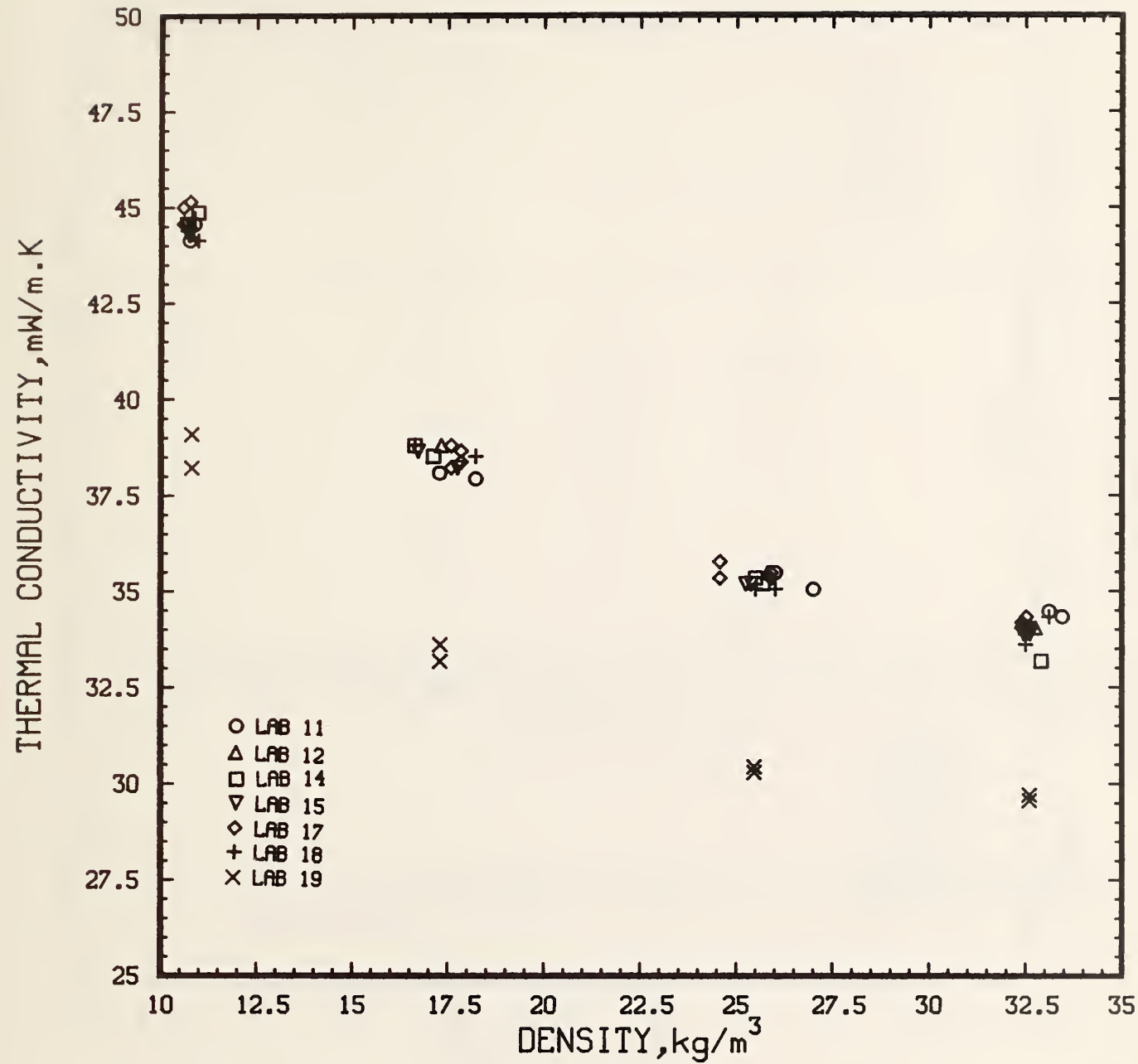

Figure 7.3 Thermal Conductivity versus Density for all Primary Round Robin II Data.

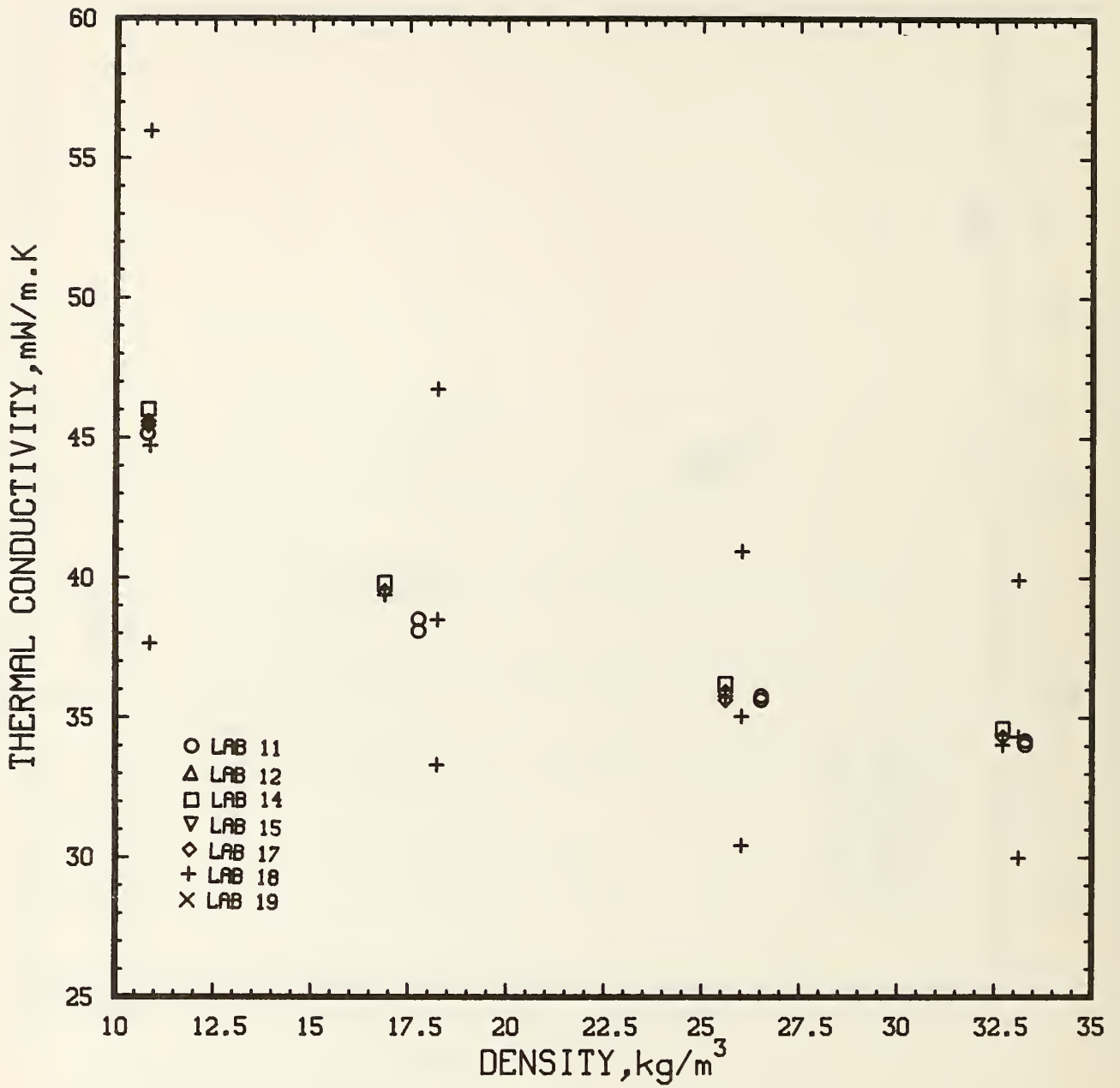

Figure 7.4 Thermal Conductivity versus Density for Supplementary Round Robin II Data.

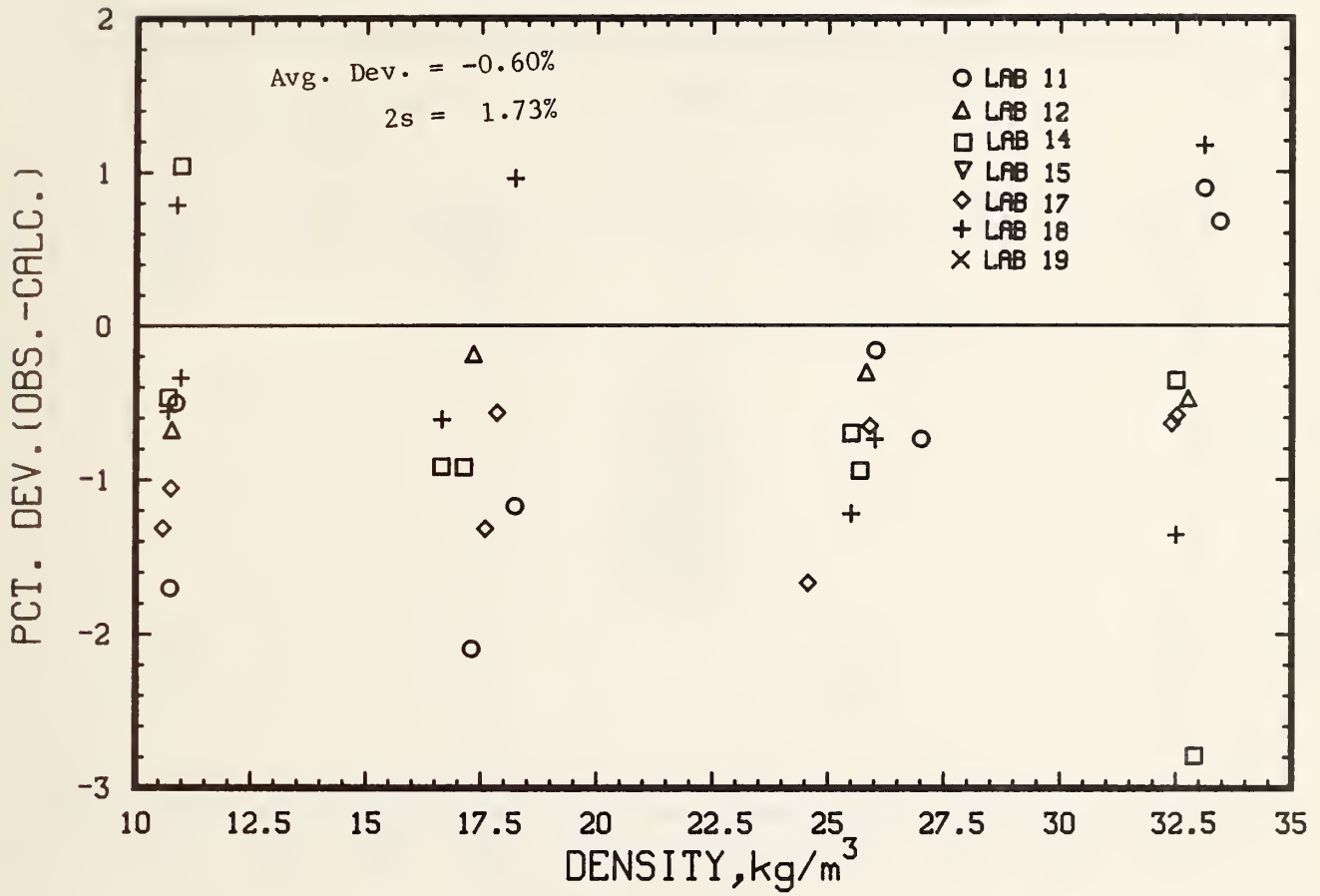

Figure 7.5 Deviations between Thermal Conductivity Data for Heat Flow Meter Apparatus from Round Robin II and Values Calculated from the Model versus Density.

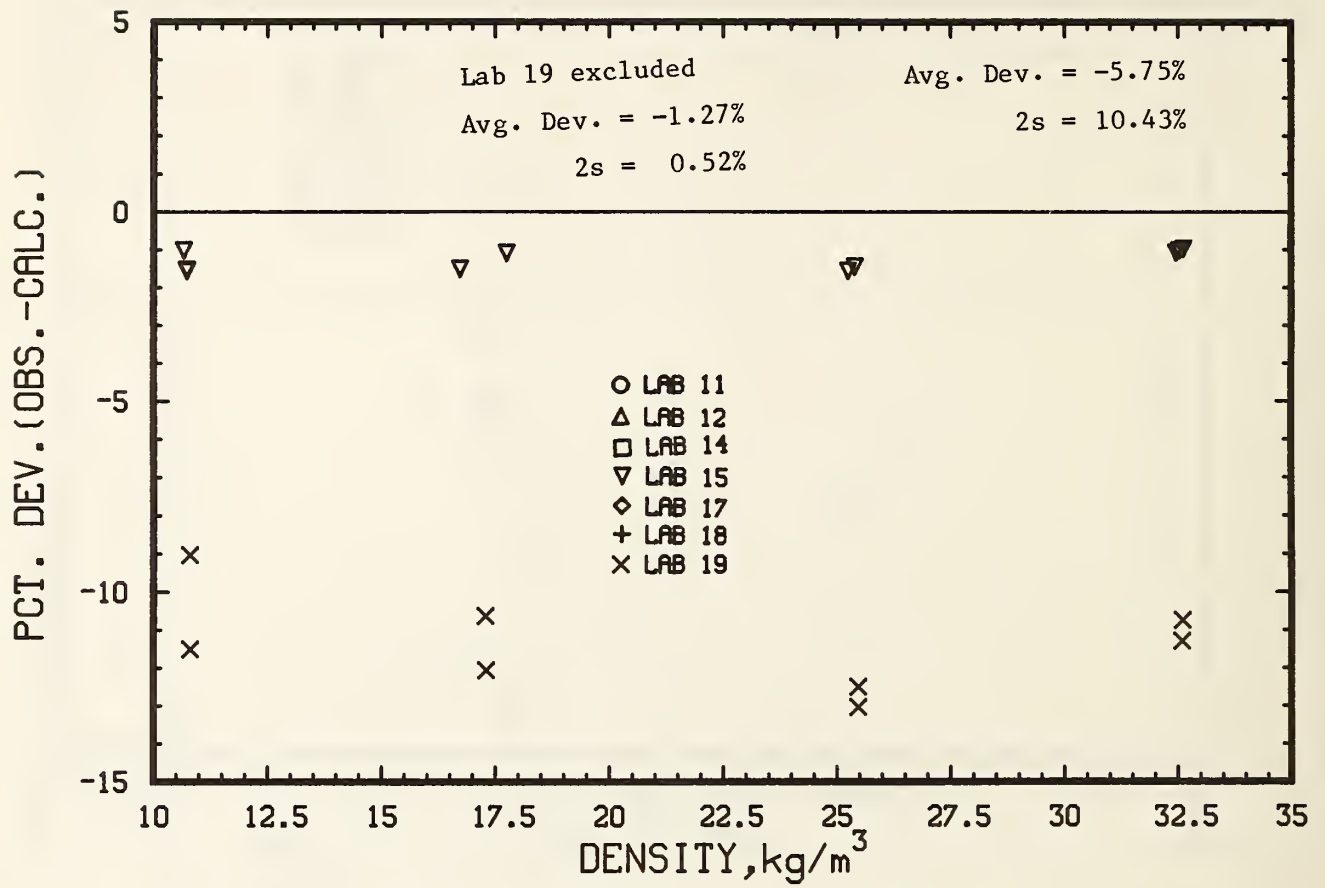

Figure 7.6 Deviations between Thermal Conductivity Data for Guarded Hot Plate Apparatus from Round Robin II and Values Calculated from the Model versus Density.

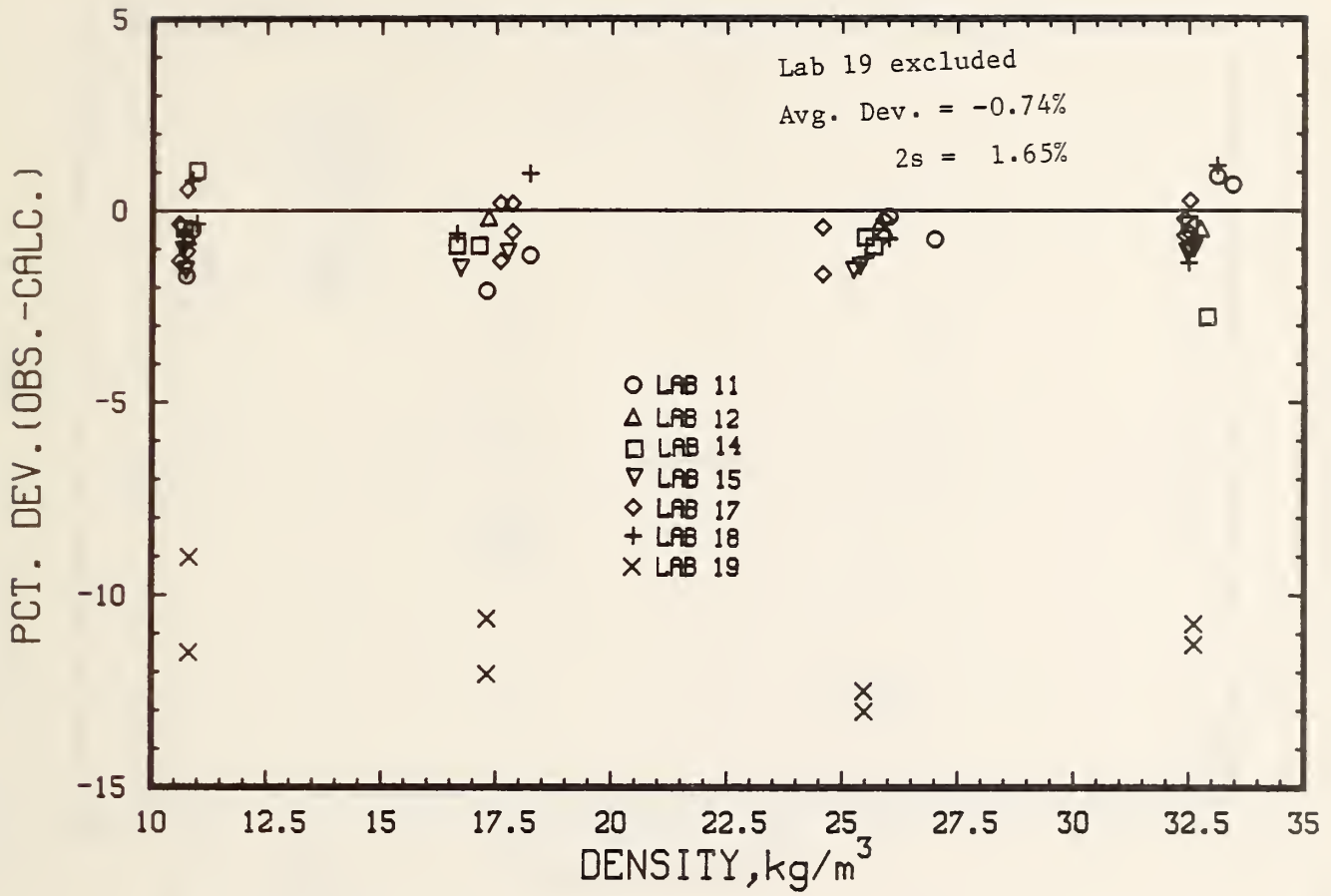

Figure 7.7 Deviations between all Primary Thermal Conductivity Data from Round Robin II and Values Calculated from the Model versus Density.

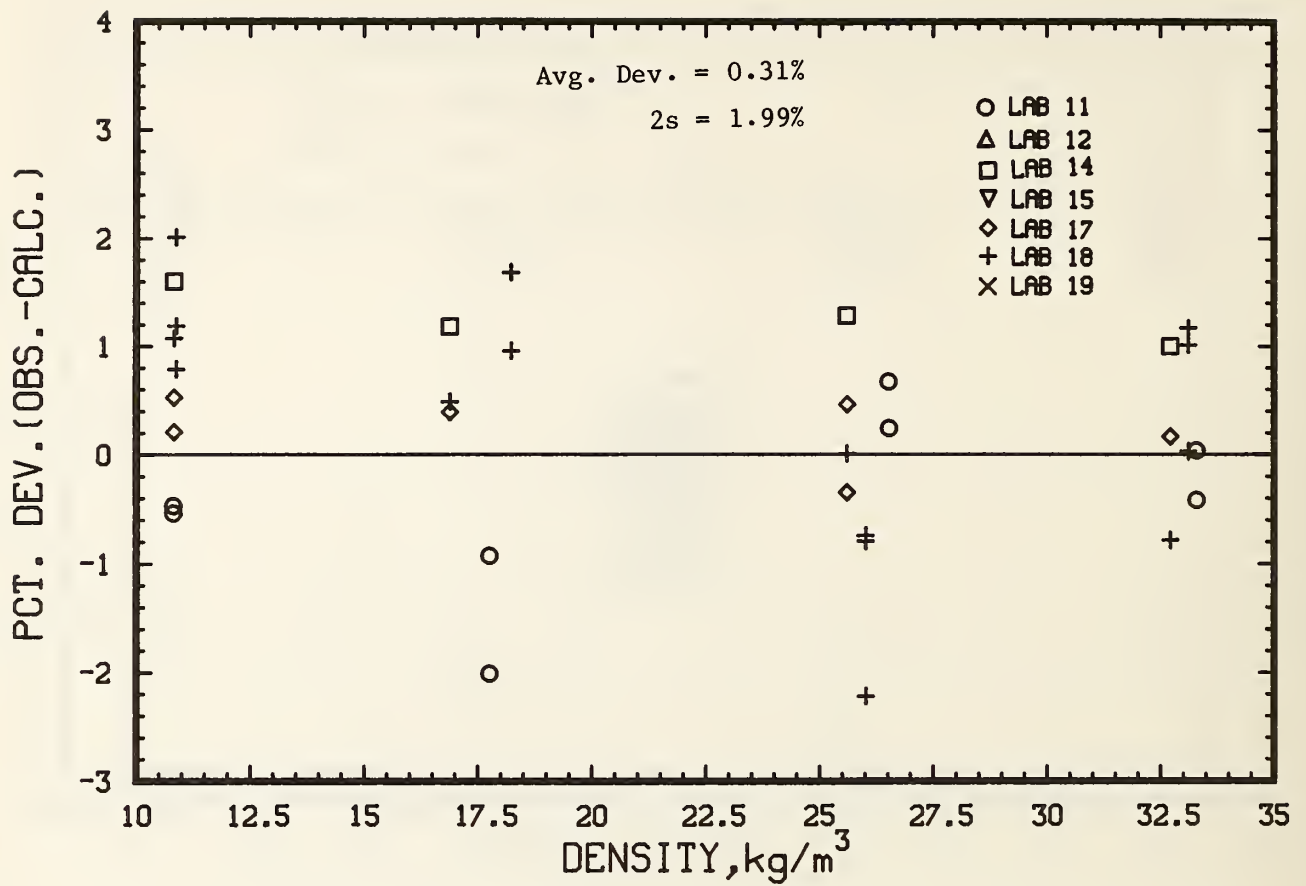

Figure 7.8 Deviations between Supplementary Thermal Conductivity Data from Round Robin II and Values Calculated from the Model versus Density.

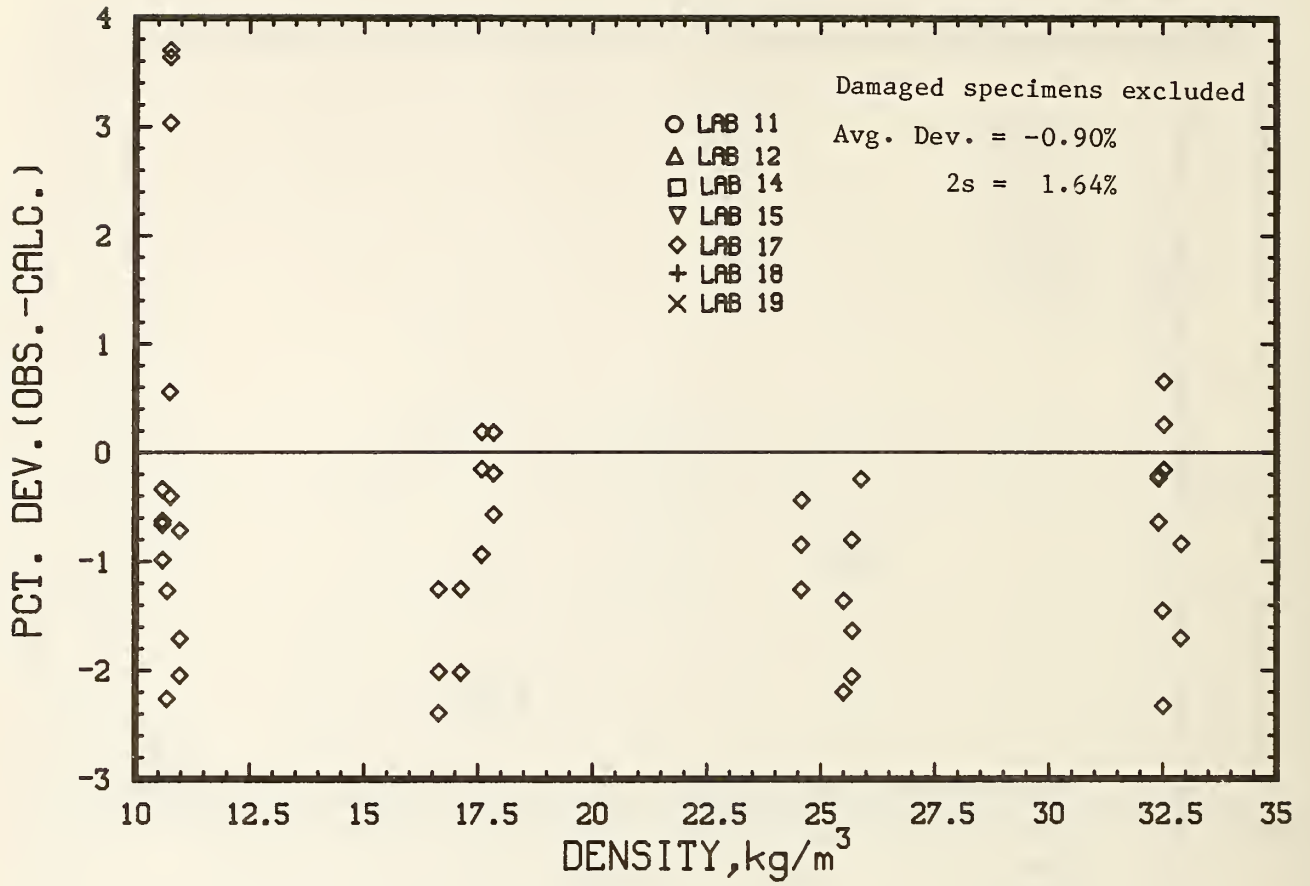

Figure 7.10 Deviations between Control Data from Lab 17 for Round Robin II and Values Calculated from the Model versus Density.

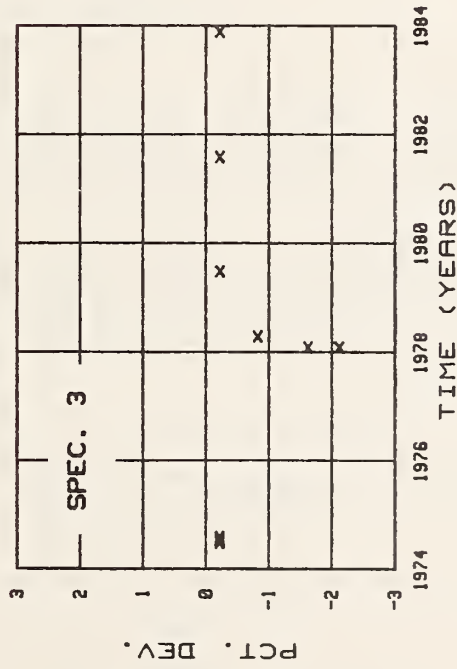
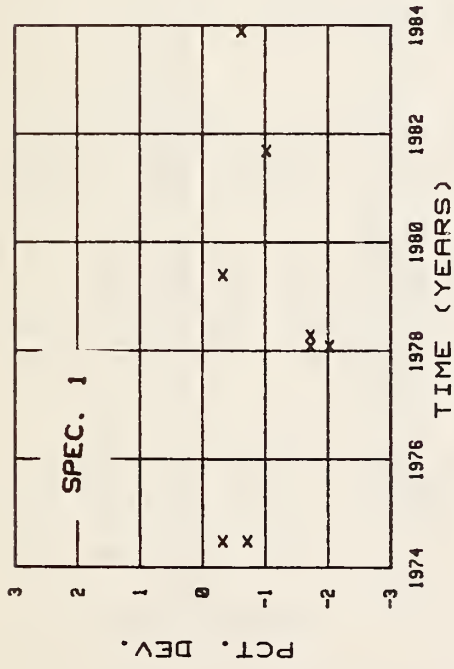
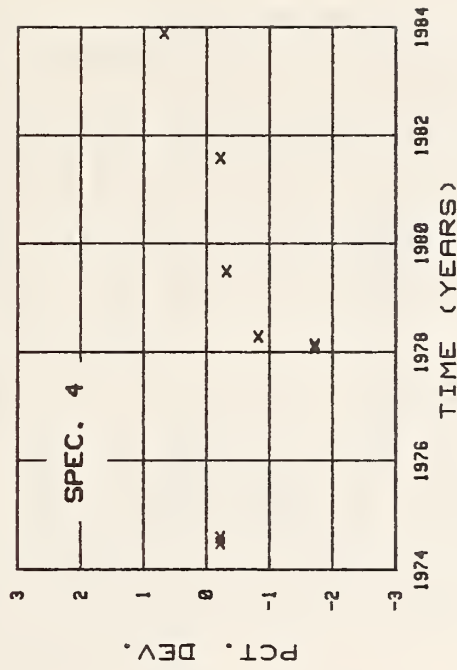
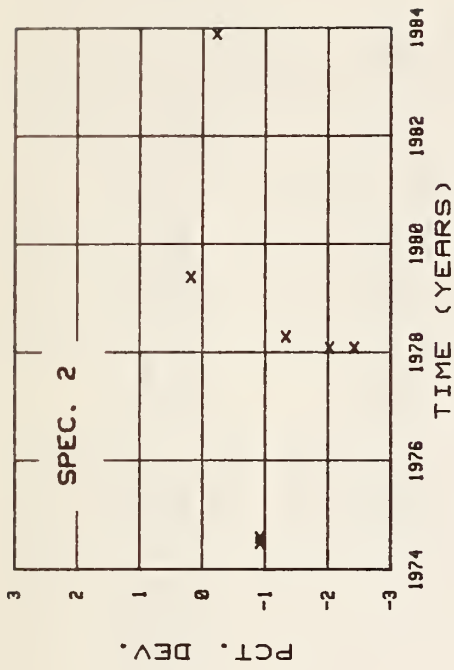

Figure 7.11 Deviations between Control Data from Lab 17 for Round Robin II and Values Calculated from the Model versus Time (Set 1).

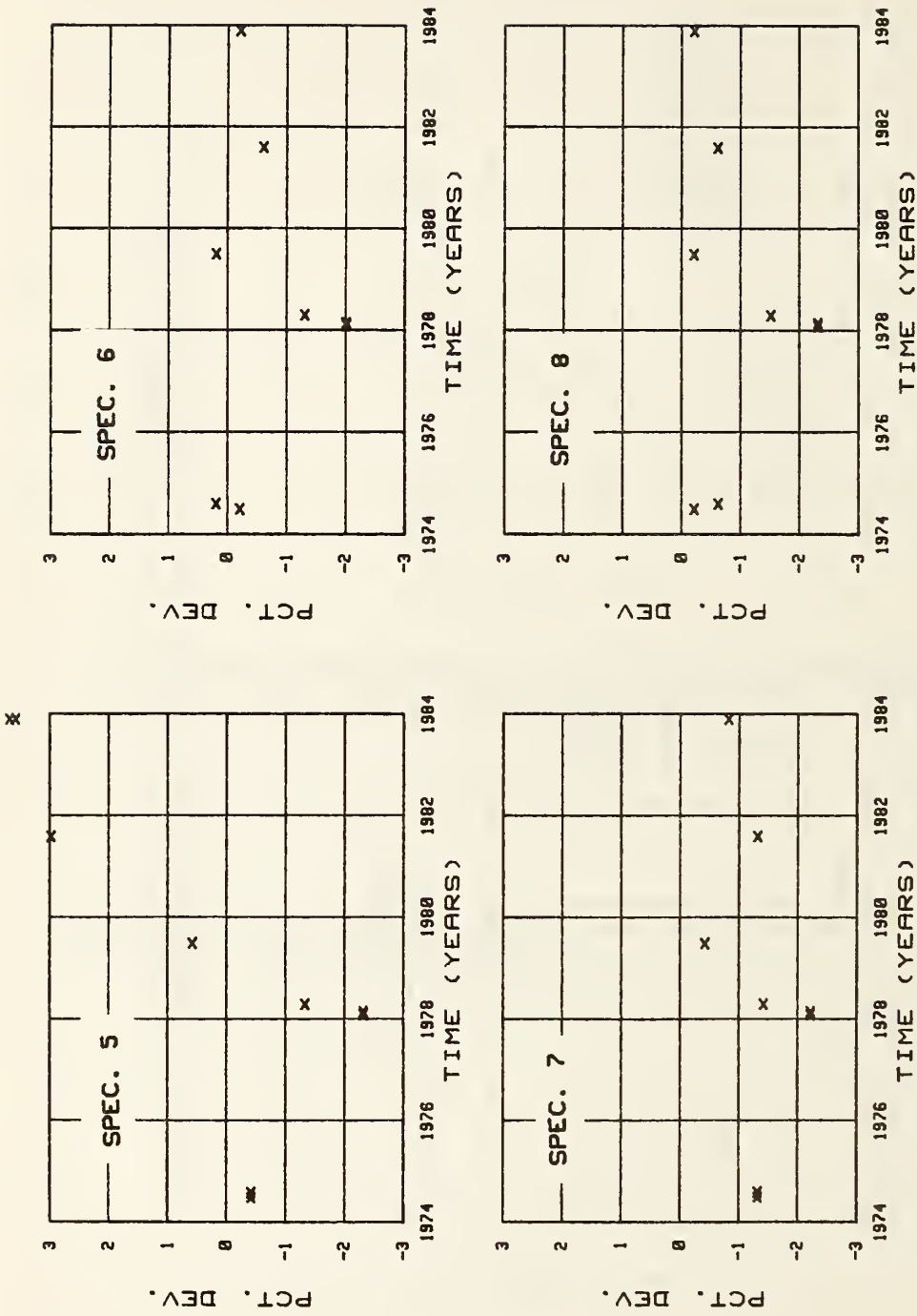

Figure 7.12 Deviations between Control Data from Lab 17 for Round Robin II and Values Calculated from the Model versus Time (Set 2).

8. ROUND ROBIN III

8.1 Overview

Round robin III was initiated following two meetings late in 1979. On September 13, 1979, a meeting was held at the National Bureau of Standards (NBS) in Gaithersburg, MD to review the status of development of the one meter line-source GHP [16] which is intended to extend the thermal measurement capabilities of NBS. One of the first and the most urgent tasks to be performed was to provide reference specimens to verify GHP's (ASTM C177) [1] and calibrate HFM's (ASTM C518) [2] for tests on low density thermal insulations at thicknesses greater than 25.4 mm (1.0 in). It was agreed that the ongoing ASTM C-16.30 round robin program could provide helpful information in the evaluation of the new NBS GHP and provide information on the measurement capabilities of existing test equipment.

On October 7, 1979, at the regular meeting of ASTM C-16 in Nashville, TN task force representatives and participants of the September 13th meeting met to consider the request. The task force agreed to carry out a round robin with increasing thicknesses of glass fiber insulation initially to cover GHP's but with future extension to large HFM's*. The tests would be limited to equipment capable of testing specimens at least 100 mm (4.0") thick. The tests were carried-out between January 1980 and April 1983.

The C-16.30 Task Force Members were,

Charles M. Pelanne, (Chairman);
Diana Kirkpatrick, (NVLAP),
and Jerome G. Hust.

The material used for the round robin consisted of eight matched pieces of 25.4 mm (1 in) thick specimens of three densities of glass fiber insulation batts. The specimens were supplied from the NVLAP inventory of low density glass fiber samples obtained from the Manville Research and Development Center.

All of the tests were performed on matched pairs of specimens at 25.4 mm (1 in), 50.8 mm (2 in), 76.2 mm (3 in), and 101.6 mm (4 in) test thickness and 24°C (75°F) mean temperature. The same specimens were circulated to all of the participating laboratories.

Table 8.1 and 8.2 show the results of the measurements as obtained during the course of RR III. The NBS data for RR III are listed in Table 5.2. Table 8.3 provides data on the matched sets as individuals instead of pairs as in the main part of the program. The data was obtained by HFM and are provided for reference only.

8.2 Test Specimens

The specimens consisted of three sets of glass fiber insulation batts, each set made up of eight, 25.4 mm (1 in) thick, matched, 610 × 610 mm (24 × 24 in) pieces. These specimens were provided by NVLAP of NBS in order to expedite the program.

*The HFM portion of this plan was not carried out.

The specimens were selected by the task force chairman from a stock of NVLAP characterized glass fiber insulation specimens. The selection and characterization of the specimens held at NBS by NVLAP allowed for a very accurate selection of the specimens required for this program. The selection was made on the basis of uniformity of weight, the predicted apparent thermal conductivity and the uniformity of density distribution within the central test area, for each of the three density groups. The apparent thermal conductivity was predicted for each specimen on the basis of weight and light transmission [15] measurements performed as part of the contract. The density distribution was also determined by means of the light transmission measurements. The specimens with the selection characteristics are listed below.

Teststack Order*	Side one		Predicted	Side two		Predicted
	Specimen Number	Density (kg/m ³)	k _a (mW·m ^a ₁ ·K ⁻¹)	Specimen Number	Density (kg/m ³)	k _a (mW·m ^a ₁ ·K ⁻¹)
<u>Set Number 1</u>						
1	81247	11.5	43.7	50138	11.5	43.6
2	82278	11.7	43.6	50975	11.5	43.6
3	50134	11.2	43.8	50533	11.4	43.7
4	81257	11.7	43.6	61663	11.5	43.7
<u>Set Number 2</u>						
1	80831	15.7	39.9	81065	15.7	39.9
2	80914	15.9	39.9	80738	15.7	39.9
3	80762	15.7	39.9	80874	15.5	39.9
4	85855	15.4	39.9	85545	15.7	40.0
<u>Set Number 3</u>						
1	11931	19.2	37.9	11761	19.2	37.9
2	11141	18.6	38.2	11911	18.1	38.4
3	12115	20.3	37.5	10155	19.2	37.9
4	10615	18.4	38.2	10575	18.7	38.1

To allow testing in large GHP's 1220 × 1220 × 25.4mm (48 × 48 × 1 in) pieces of insulation from the same production lot as the material supplied to NBS for the NVLAP program were provided. These large pieces were selected to match the density of the specimens they were to guard. The stacking order for these pieces and the test specimens is shown in the appendix. The center 610 × 610 mm portions were cut out to form frames for the test specimens.

The density of each individual piece was determined for the whole 610 mm specimen and in order to relate the test density to the apparatus test area each piece was cut and weighed to successively smaller sizes matching the test areas. A total of one hundred and twenty density determinations for individual specimens covering the range of test areas and nominal densities were made. Ninety cumulative density calculations were made for the various stacked thicknesses. The details are reported in Table 13.6.

*Teststack order indicates the order in which the specimens were stacked to achieve the various test thicknesses.

8.3 Test Equipment

Five GHP's were involved in this round robin. These were as follows;

Apparatus type	Number	Overall size	Test area
Square GHP	1	1219×1219 mm (48×48 in)	457×457 mm (18×18 in)
" "	1	914×914 mm (36×36 in)	406×406 mm (16×16 in)
" "	2	610×610 mm (24×24 in)	305×305 mm (12×12 in)
Cir.line-source GHP	1	1016 mm diam. (40in diam)	406 mm diam. (16in diam)

8.4 Results

The test dates ran from January 1980 to April 1983. In some instances the tests were performed in two different periods during the course of the round robin.

Round robin III was conducted on three sets of specimens with different nominal densities and at four thicknesses, the results were analyzed as a function of both density and thickness.

All of the apparent thermal conductivity data are plotted as a function of density in Figure 8.1. It is interesting to note that the spread of the data is nearly the same for each nominal density. The spread is a measure of a) specimen inhomogeneity, b) experimental imprecision (both intra- and inter laboratory) and c) the effect of thickness. The latter is expected to be larger at low density but the effect is nearly hidden in the overall scatter on this plot. All of the data are plotted as a function of thickness in Figure 8.2. The data are grouped in three categories representing each of the nominal densities. Here the effect of thickness is clearer but it should be noted that the effect is only marginally greater than the overall spread in the data for each density. The effect of thickness at the highest density is within the spread of the data. Some overlap exists between the results obtained on the two higher densities. The deviation of all of the RR III results from the model are shown in Figure 8.3 as a function of density and in Figure 8.4 as a function of thickness.

The average deviation from the model and the 2s value for each data subset are shown on the deviation plots.

These figures show that the interlaboratory spread is about 2.5% around the experimental mean value, which is greater than for RR I and RR II. The intralaboratory spread is about half of the interlaboratory spread.

In this case, it was desirable to separately plot the deviations for each nominal density as a function of thickness and for each thickness as a function of density. Figures 8.5 through 8.8 show the deviations as a function of density for the 25.4, 50.8, 76.2 and 101.6 mm thicknesses, respectively.

Figures 8.9 through 8.11 show the deviations as a function thickness for the three nominal densities, 11, 16, and 19 kg/m³, (0.7, 1.0, and 1.2 lb/ft³), respectively.

The percent deviations (observed - calculated) are also listed in the last column of Tables 5.2, 8.1, and 8.2. Since the three round robins are closely related, the detailed discussion of the significance of these results is relegated to section 9 of this report.

Table 8.1 ASTM C-16.30/MIMA Round Robins. Primary Data for Round Robin III.*

RR NO.	LAB NO.	DATE M Y	EQUIP TYPE	TEST COND.	SPEC. NO.	THICK. cm	DENS. kg/m ³	HOT TEMP	COLD TEMP	MEAN TEMP	k mW/(m ² ·K)	FOOT-NOTES	PCT
III	12	0180	G4818	507	1	2.54	11.58	308.2	286.1	297.1	43.8		1.7
III	12	0180	G4818	607	12	5.08	11.44	308.2	286.0	297.1	44.4		1.7
III	12	0180	G4818	707	123	7.62	11.44	308.2	286.0	297.1	44.7		2.0
III	12	0180	G4818	807	1234	10.16	11.39	308.2	286.0	297.1	44.9		2.0
III	12	0180	G4818	509	1	2.54	15.68	308.2	286.0	297.1	39.7		0.7
III	12	0180	G4818	609	12	5.08	15.71	308.2	286.0	297.1	40.2		1.6
III	12	0180	G4818	709	123	7.62	15.70	308.3	286.0	297.1	40.4		1.7
III	12	0180	G4818	809	1234	10.16	15.63	308.2	286.0	297.1	40.7		2.2
III	12	0180	G4818	512	1	2.54	19.40	308.2	286.0	297.1	37.6		0.8
III	12	0180	G4818	612	12	5.08	19.09	308.2	286.0	297.1	38.1		1.1
III	12	0180	G4818	712	123	7.62	19.33	308.2	286.0	297.1	38.2		1.6
III	12	0180	G4818	812	1234	10.16	19.25	308.2	286.1	297.1	38.5		2.2
III	15	1080	G2412	507	1	2.54	11.85	310.9	283.3	297.1	43.1		0.9
III	15	1080	G2412	607	12	5.08	11.47	310.8	283.0	296.9	43.7		0.3
III	15	1080	G2412	707	123	7.62	11.50	311.4	283.1	297.2	44.0		0.4
III	15	1080	G2412	807	1234	10.16	11.39	311.3	283.2	297.2	44.4		0.9
III	15	1080	G2412	509	1	2.54	15.30	310.8	283.2	297.0	39.4		-0.6
III	15	1080	G2412	609	12	5.05	15.49	310.9	283.0	297.0	39.7		-0.2
III	15	1080	G2412	709	123	7.62	15.60	310.9	283.0	296.9	40.0		0.6
III	15	1080	G2412	809	1234	10.16	15.51	310.5	282.9	296.7	40.1		0.7
III	15	1180	G2412	512	1	2.54	19.21	311.0	283.2	297.1	37.5		0.1
III	15	1180	G2412	612	12	5.05	18.89	310.5	283.0	296.8	37.6		-0.2
III	15	1180	G2412	712	123	7.59	19.32	310.9	283.0	297.0	37.8		0.6
III	15	1180	G2412	812	1234	10.16	19.27	310.5	282.9	296.7	38.1		1.3
III	18	0483	G2412	507	1	2.54	11.85	309.7	282.5	296.1	43.4	ed	2.1
III	18	0483	G2412	607	12	5.08	11.47	311.0	283.8	297.4	45.0	ed	2.8
III	18	0483	G2412	707	123	7.62	11.50	311.2	283.7	297.4	44.6	ed	1.6
III	18	0483	G2412	807	1234	10.16	11.39	311.2	283.5	297.3	44.6	ed	1.2
III	18	0483	G2412	509	1	2.54	15.30	311.2	284.4	297.8	39.2	ed	-1.5
III	18	0483	G2412	609	12	5.08	15.49	310.0	283.1	296.6	40.1	ed	1.1
III	18	0483	G2412	709	123	7.62	15.60	311.2	283.0	297.1	39.8	ed	0.1
III	18	0483	G2412	809	1234	10.16	15.51	310.4	283.2	296.8	40.0	ed	0.4
III	18	0483	G2412	512	1	2.54	19.21	311.2	284.1	297.7	37.5	ed	-0.1
III	18	0483	G2412	612	12	5.08	18.89	310.7	283.7	297.2	38.2	ed	1.2
III	18	0483	G2412	712	123	7.62	19.32	310.9	283.5	297.2	38.1	ed	1.2
III	18	0483	G2412	812	1234	10.16	19.27	311.0	283.4	297.2	37.9	ed	0.7
III	22	1182	G3616	507	1	2.54	11.74	306.7	287.2	296.9	43.3	cpu	1.0
III	22	1182	G3616	607	12	5.08	11.50	310.9	283.6	297.3	43.3	cpu	-0.9
III	22	1182	G3616	707	123	7.62	11.50	310.8	283.9	297.4	45.6	cpu	3.8
III	22	1182	G3616	807	1234	10.16	11.42	310.2	283.9	297.0	44.1	cpu	0.5
III	22	0481	G3616	509	1	2.54	15.70	304.8	286.8	295.8	39.8	cpu	1.8
III	22	0481	G3616	609	12	5.08	15.78	308.3	284.8	296.5	40.5	cpu	2.7
III	22	0481	G3616	709	123	7.62	15.76	308.3	284.8	296.5	40.8	cpu	3.2
III	22	0481	G3616	809	1234	10.16	15.68	310.3	286.5	298.4	40.8	cpu	2.0
III	22	0481	G3616	512	1	2.54	19.41	306.8	286.9	296.8	38.2	cpu	2.4
III	22	0481	G3616	612	12	5.08	19.11	309.3	284.8	297.1	38.8	cpu	3.0
III	22	0481	G3616	712	123	7.62	19.43	310.1	284.7	297.4	39.1	cpu	3.7
III	22	0481	G3616	812	1234	10.16	19.38	309.3	284.8	297.0	40.0	cpu	5.9

*Lab 13 data are given in Table 5.2

cpu: Tests performed with insulated cold plates
 cpu: Tests performed with uninsulated cold plates
 ed: Equipment difficulty reported

Table 8.2 ASTM C-16.30/MIMA Round Robins. Secondary Data for Round Robin III.

RR NO.	LAB NO.	DATE M Y	EQUIP TYPE	TEST COND.	SPEC. NO.	THICK. cm	DENS. kg/m ³	HOT TEMP	COLD TEMP	MEAN TEMP	k _s mW/(m ² ·K)	FOOT-NOTES	PCT
III	12	0180	G4818	507	2	2.54	11.29	308.2	285.9	297.0	43.7	i	0.7
III	12	0180	G4818	507	3	2.54	11.40	308.2	285.9	297.0	43.0	i	-0.7
III	12	0180	G4818	507	4	2.54	11.24	308.2	285.9	297.0	43.6	i	0.2
III	12	0180	G4818	509	2	2.54	15.75	308.2	285.9	297.0	39.8	i	1.2
III	12	0180	G4818	509	3	2.54	15.70	308.2	285.9	297.0	39.5	i	0.4
III	12	0180	G4818	509	4	2.54	15.44	308.2	285.9	297.0	40.1	i	1.4
III	12	0180	G4818	512	2	2.54	18.79	308.2	285.9	297.0	37.9	i	0.8
III	12	0180	G4818	512	3	2.54	19.83	308.2	285.9	297.0	37.4	i	0.5
III	12	0180	G4818	512	4	2.54	18.97	308.2	285.9	297.0	37.9	i	1.0

i: Temperature not given. Data assumed on basis of other data.

Table B.3 ASTM C 16, W/MIMA Round Robins Tests Performed at Lab 17 on Individual Stacked Sets of Specimens from Round Robin 111 using Heat Meter Apparatus

RR NO.	LAB NO.	DATE M-Y	EQIP TYPE	TEST CURD	SPCG. MO	THICK. cm	DEN. kg/m ³	HRD CORP	USED HMR	HEAT HMR	$\frac{h}{mw} (\frac{m}{kg \cdot K})$	LOSI MOLES	PL
111	17	1003	03612	109	1	2.54	15.67	110.9	203.2	297.0	19.7		0.7
111	17	1003	03612	109	5	2.54	15.57	110.9	203.2	297.0	19.7		0.5
111	17	1003	03612	509	1	2.54	15.62	110.9	203.2	297.0	19.5	cal	0.3
111	17	1003	03612	309	12	5.08	15.63	110.9	203.2	297.0	40.0		0.0
111	17	1003	03612	309	56	5.08	15.51	110.9	203.2	297.0	19.7		0.2
111	17	1003	03612	609	12	5.08	15.57	110.9	203.2	297.0	19.0	cal	0.3
111	17	1003	03612	109	123	7.62	15.60	110.9	203.2	297.0	19.7		0.2
111	17	1003	03612	109	567	7.62	15.60	110.9	203.2	297.0	19.7	cal	0.2
111	17	1003	03612	709	123	7.62	15.60	110.9	203.2	297.0	19.7		0.2
111	17	1003	03612	309	1234	10.16	15.59	110.9	203.2	297.0	40.0		0.4
111	17	1003	03612	309	5678	10.16	15.44	110.9	203.2	297.0	40.1	cal	0.5
111	17	1003	03612	309	1234	10.16	15.51	110.9	203.2	297.0	40.1		0.6
113	17	1003	03612	112	1	2.54	19.14	110.9	203.2	297.0	17.5		0.1
111	17	1003	03612	112	5	2.54	19.25	110.9	203.2	297.0	17.5		0.2
111	17	1003	03612	512	1	2.54	19.21	110.9	203.2	297.0	17.5	cal	0.2
111	17	1003	03612	312	12	5.08	18.64	110.9	203.2	297.0	30.1		0.5
111	17	1003	03612	112	56	5.08	19.13	110.9	203.2	297.0	17.9		0.0
111	17	1003	03612	612	12	5.08	18.89	110.9	203.2	297.0	17.9	cal	0.5
113	17	1003	03612	312	123	7.62	19.51	110.9	203.2	297.0	17.5		0.0
111	17	1003	03612	312	567	7.62	19.27	110.9	203.2	297.0	17.0		0.4
111	17	1003	03612	712	123	7.62	19.30	110.9	203.2	297.0	17.6	cal	0.2
111	17	1003	03612	312	1234	10.16	19.37	110.9	203.2	297.0	17.0		0.5
111	17	1003	03612	312	5678	10.16	19.29	110.9	203.2	297.0	30.1		1.1
111	17	1003	03612	312	1234	10.16	19.27	110.9	203.2	297.0	17.9	cal	0.0
111	17	1003	03612	107	1	2.54	11.05	110.9	203.2	297.0	42.4		-0.0
111	17	1003	03612	107	5	2.54	11.04	110.9	203.2	297.0	41.6		1.0
111	17	1003	03612	507	1	2.54	11.05	110.9	203.2	297.0	43.0	cal	0.6
113	17	1003	03612	307	12	5.08	11.69	110.9	203.2	297.0	41.4		0.2
113	17	1003	03612	307	56	5.08	11.24	110.9	203.2	297.0	41.0		0.2
113	17	1003	03612	607	12	5.08	11.47	110.9	203.2	297.0	43.7	cal	0.2
111	17	1003	03612	307	123	7.62	11.76	110.9	203.2	297.0	41.0		1.0
111	17	1003	03612	307	567	7.62	11.24	110.9	203.2	297.0	41.7		0.9
111	17	1003	03612	707	123	7.62	11.50	110.9	203.2	297.0	41.0	cal	0.3
111	17	1003	03612	307	1234	10.16	11.66	110.9	203.2	297.0	41.0		0.6
111	17	1003	03612	307	5678	10.16	11.10	110.9	203.2	297.0	44.0		-0.9
111	17	1003	03612	307	1234	10.16	11.42	110.9	203.2	297.0	44.0	cal	0.2

cal. Average values calculated for the previous pair of specimens.

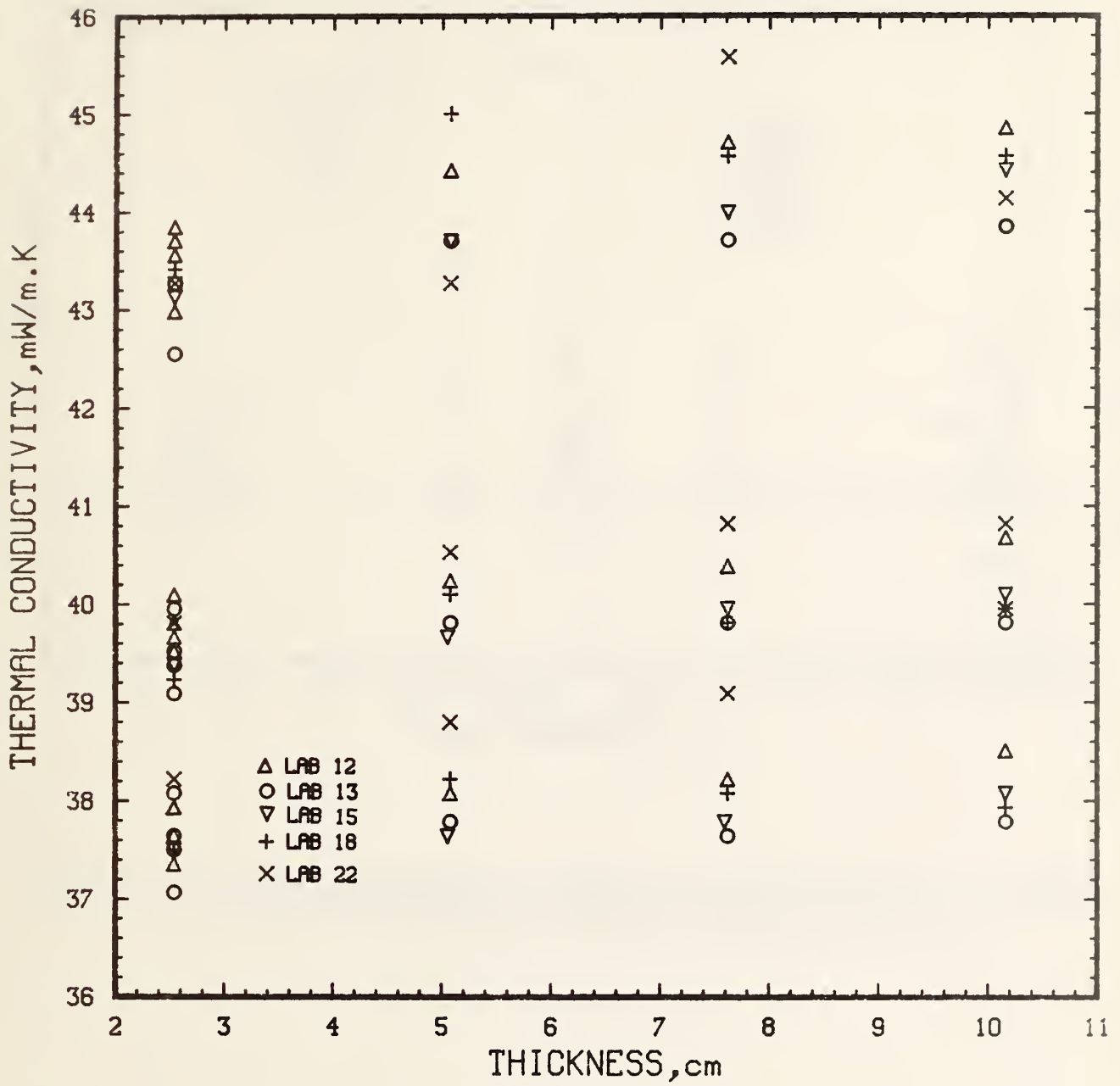

Figure 8.2 Thermal Conductivity versus Thickness of all Round Robin III Data.

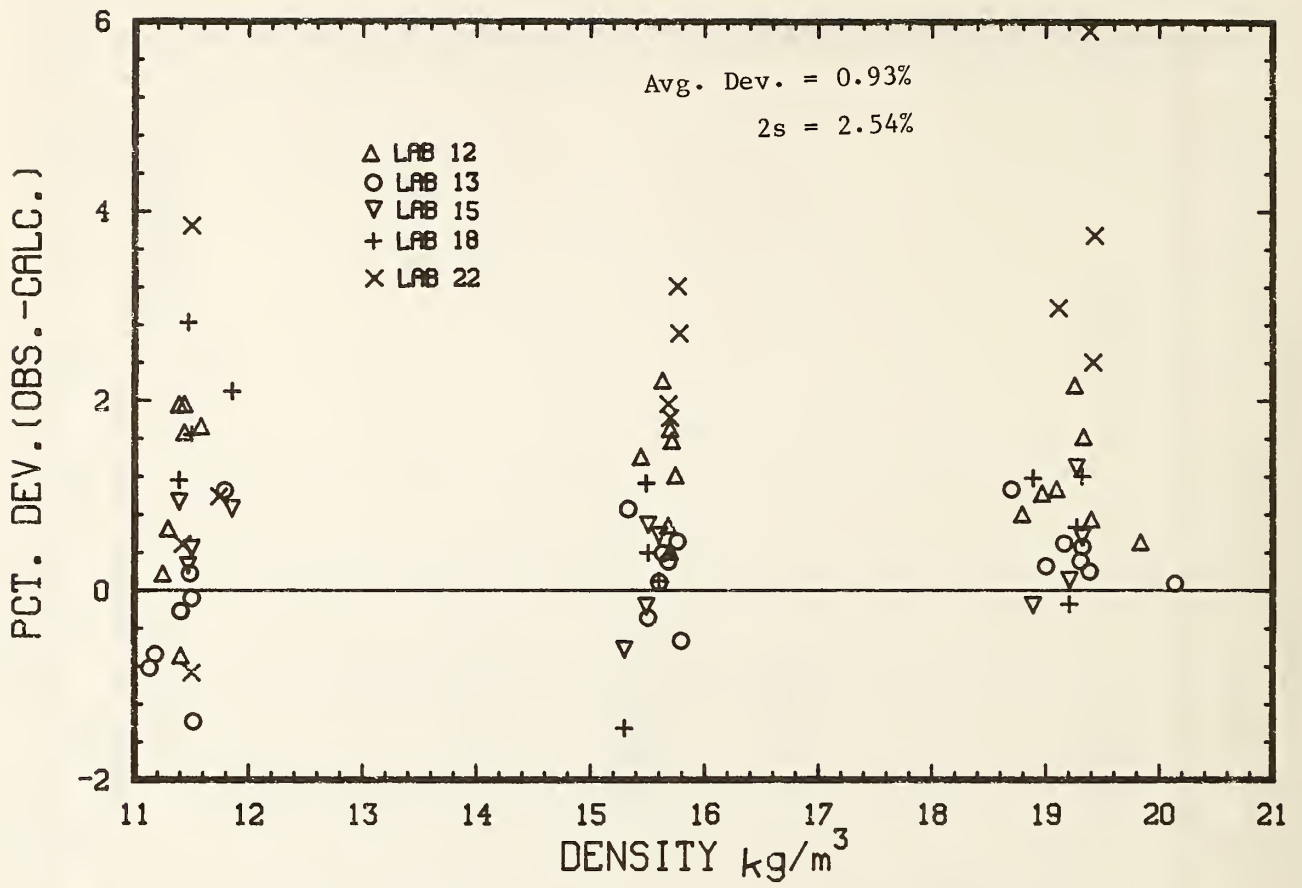

Figure 8.3 Deviations between all Thermal Conductivity Data From Round Robin III and Values Calculated from the Model versus Density.

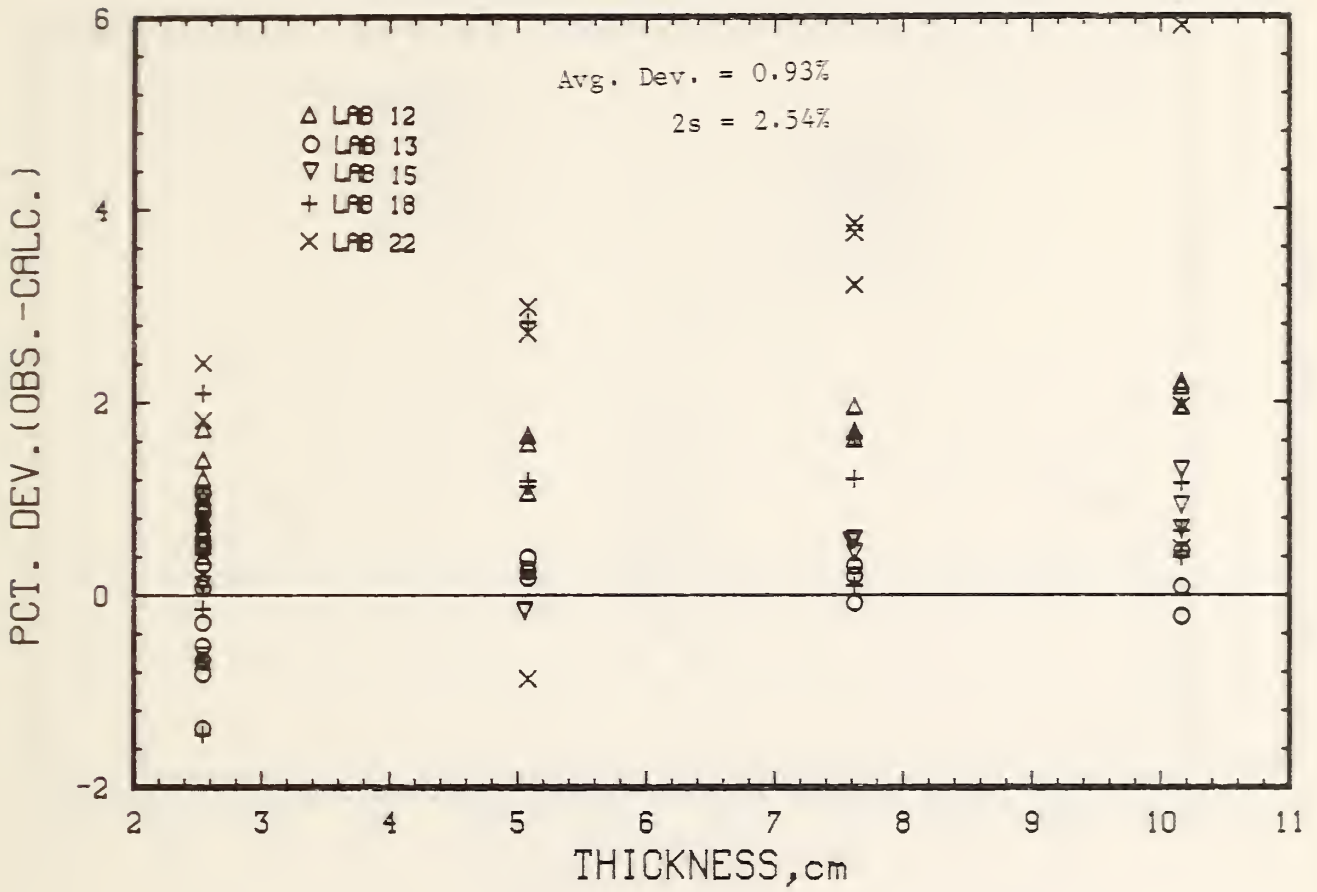

Figure 8.4 Deviations between All Thermal Conductivity Data from Round Robin III and Values Calculated from the Model versus Thickness.

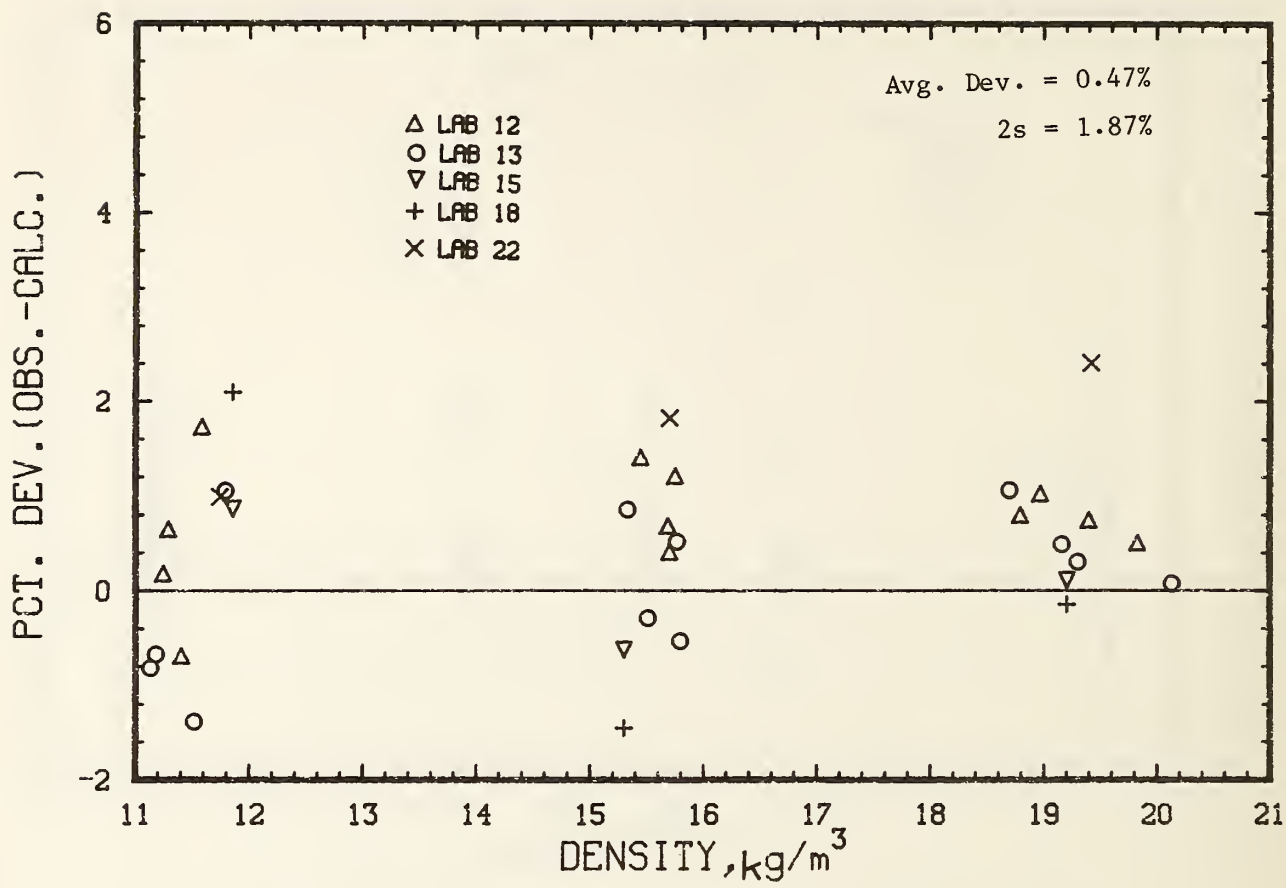

Figure 8.5 Deviations between the Thermal Conductivity Data from Round Robin III at a Thickness of 25.4 mm and Values Calculated from the Model versus Density.

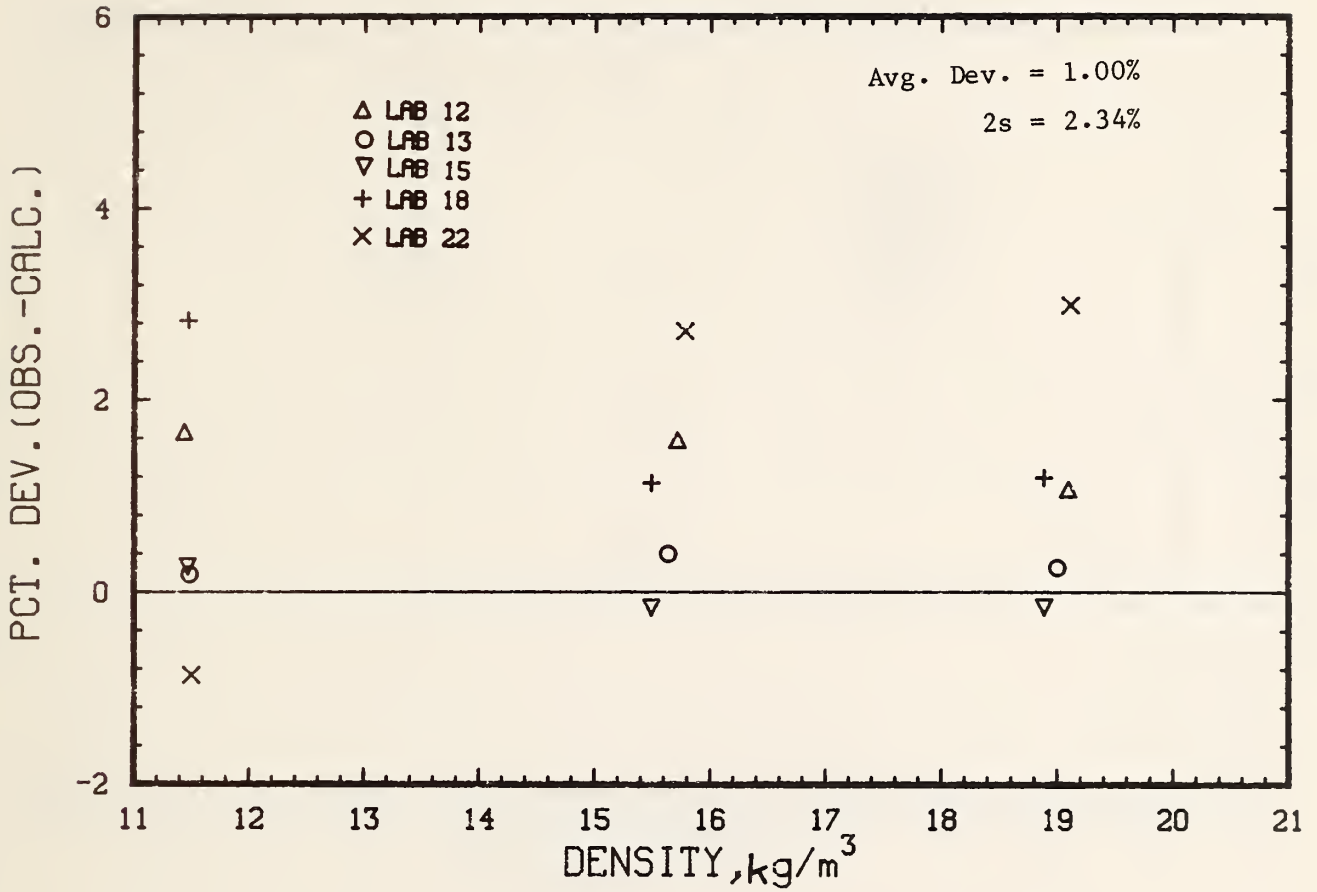

Figure 8.6 Deviations between the Thermal Conductivity Data from Round Robin III at a Thickness of 50.8 mm and values Calculated from the Model versus Density.

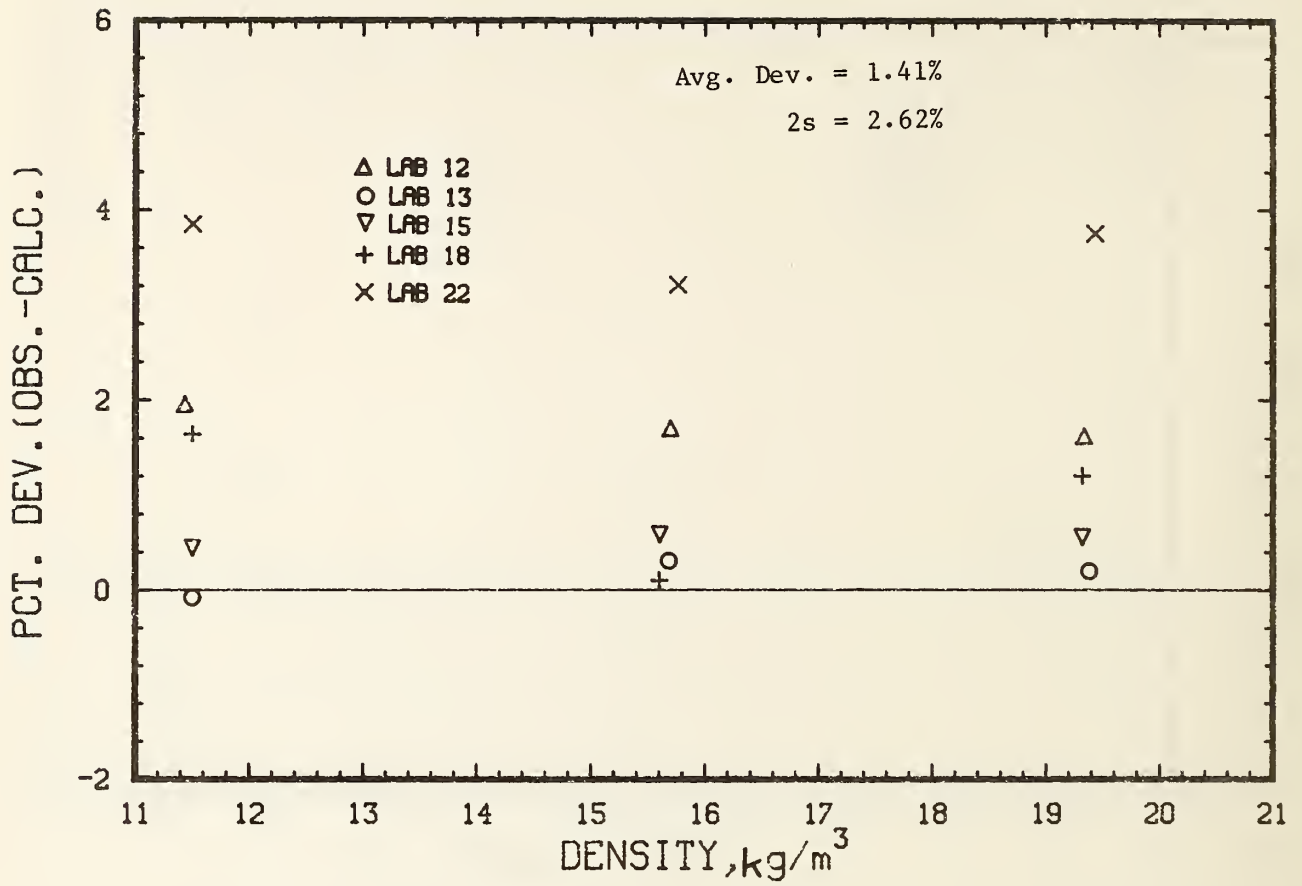

Figure 8.7 Deviations between the Thermal Conductivity Data from Round Robin III at a thickness of 76.2 mm and values Calculated from the Model versus Density.

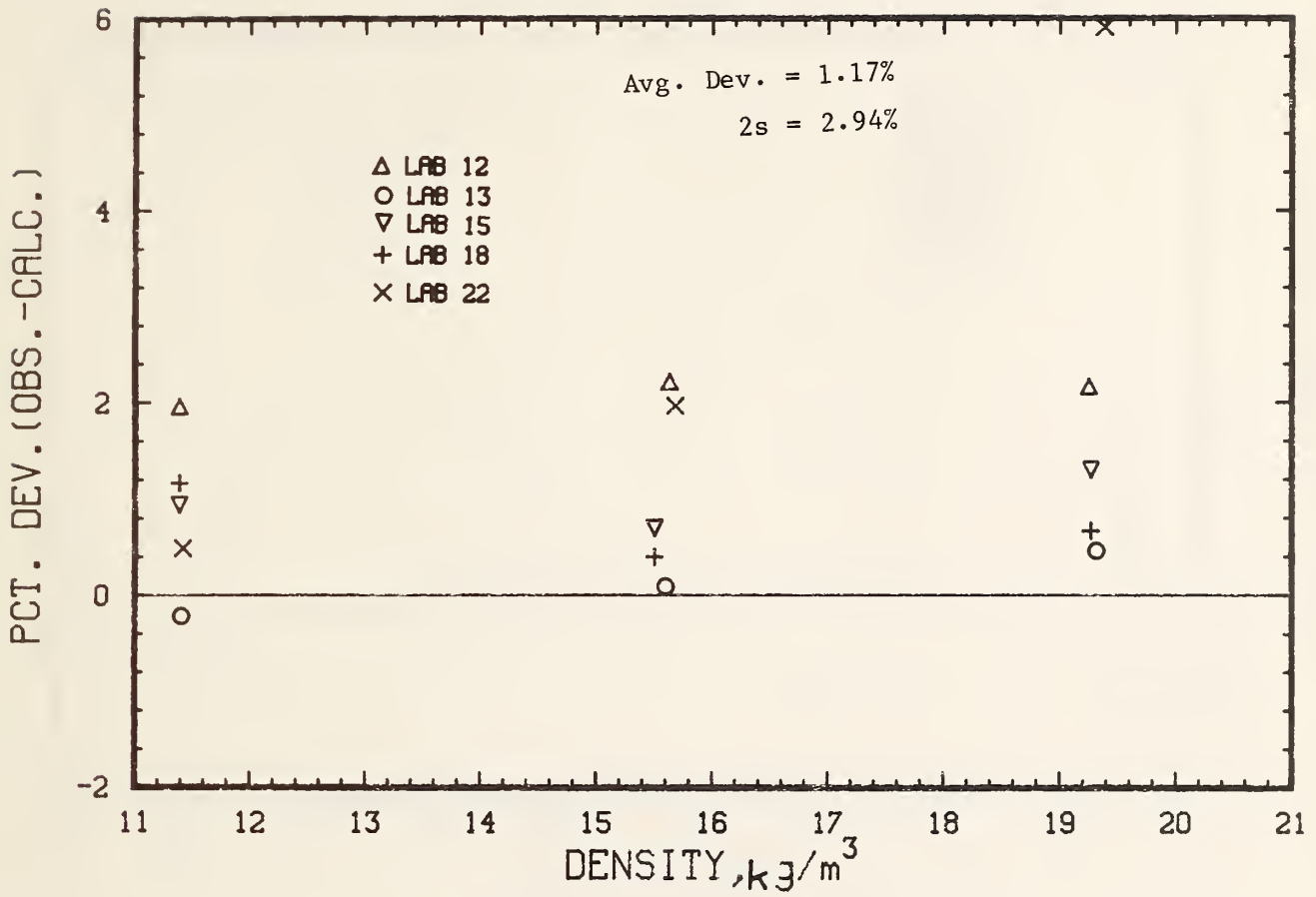

Figure 8.8 Deviations between the Thermal Conductivity Data from Round Robin III at a thickness of 101.6 mm and values Calculated from the Model versus Density.

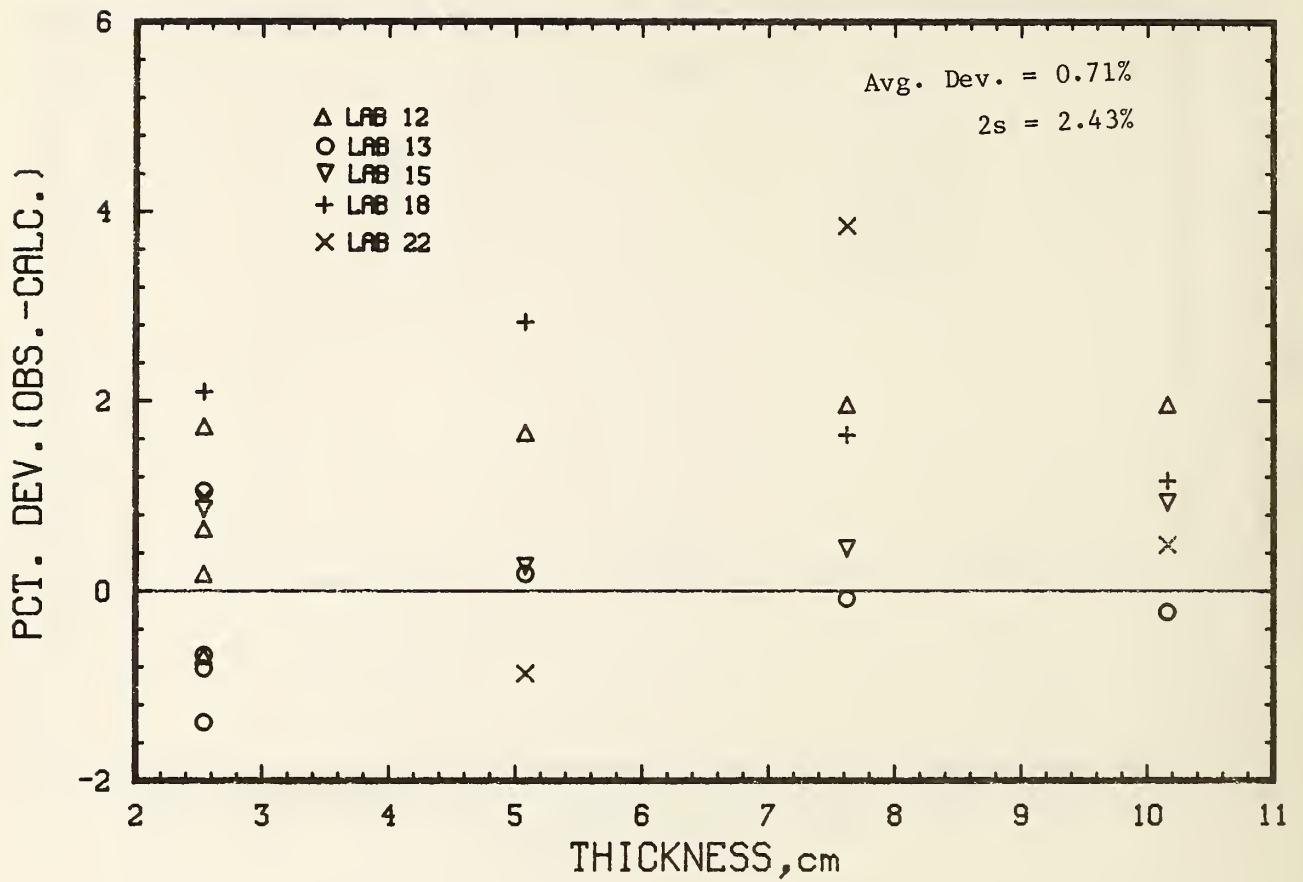

Figure 8.9 Deviations between the Thermal Conductivity Data from Round Robin III at a Nominal Density of 11 kg/m³ and Values Calculated from the Model versus Thickness.

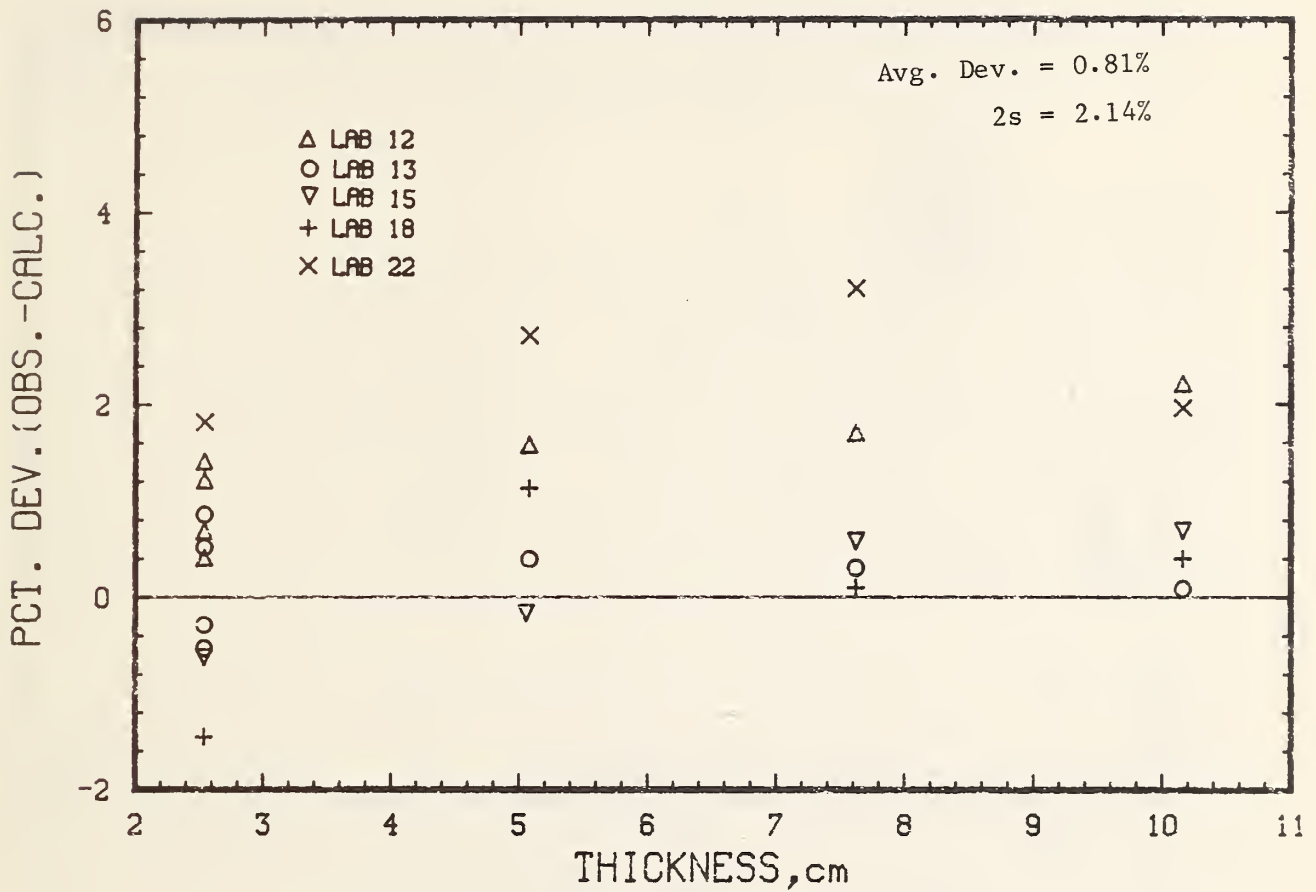

Figure 8.10 Deviations between the Thermal Conductivity Data from Round Robin III at a Nominal Density of 16 kg/m³ and Values Calculated from the Model versus Thickness.

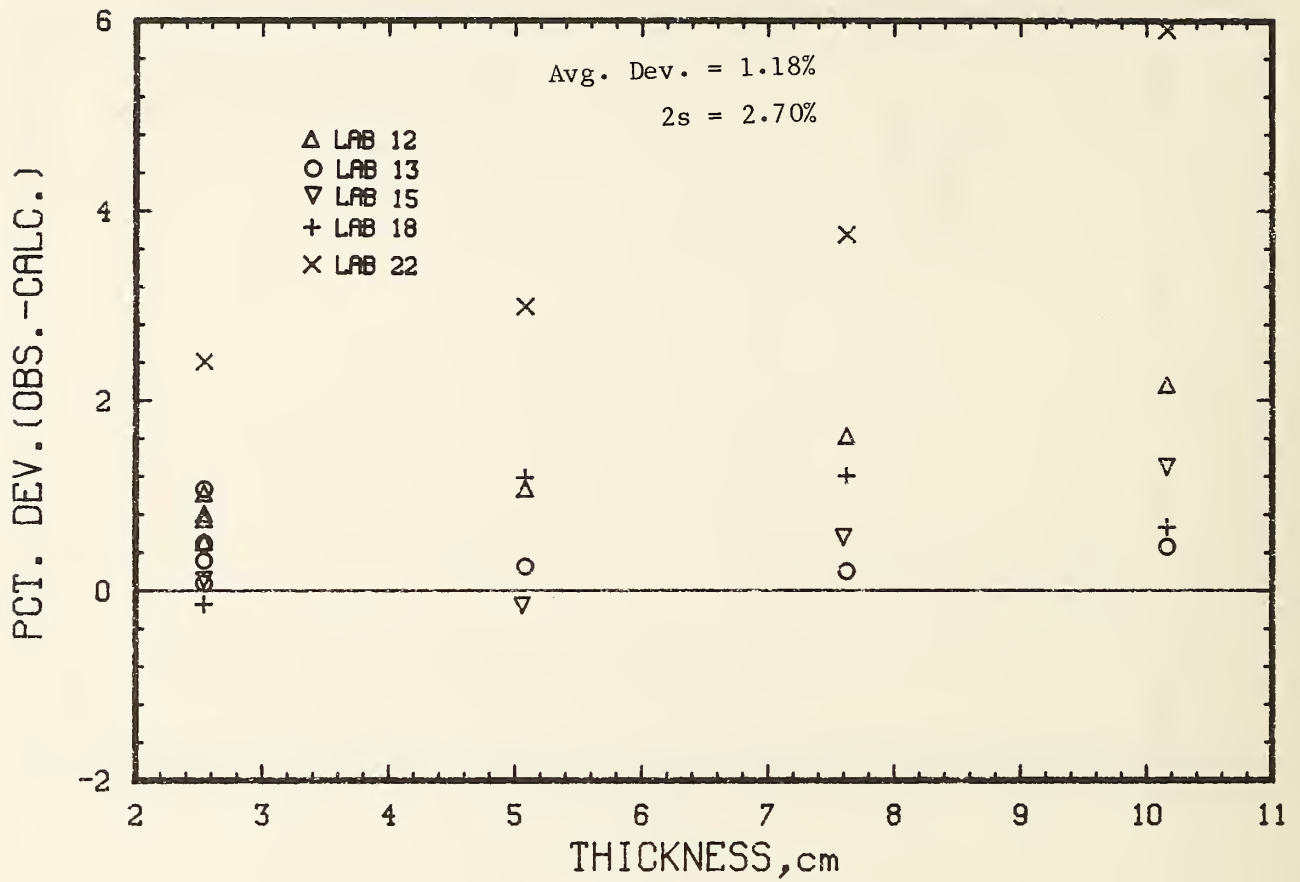

Figure 8.11 Deviations between the Thermal Conductivity Data from Round Robin III at a Nominal Density of 19 kg/m³ and Values Calculated from the Model versus Thickness.

9. SUMMARY AND CONCLUSIONS

Because of the interrelationship of the objectives and conclusions of the three round robins, the discussion for each of them will be given in this section. First we address the separation of test result variability caused by specimen inhomogeneity as contrasted with that caused by measurement imprecision. Then we discuss the conclusions for each round robin.

9.1 Separation of Variabilities

The usual objective of a round robin study is to determine the measurement variability of a group of laboratories for a given property of a given test specimen. This objective is frequently complicated, as it is here, by the effect of unquantified specimen characteristics because of differences in apparatus size and configuration. In these round robins the objective is further complicated because of the range of test conditions investigated (temperature, specimen density and thickness). The test results have been compared here to the model described in section 6 to minimize the effect of the additional range of test conditions. To the extent that the model provides a description of these dependencies, that objective has been achieved. Since essentially all of the data are within a few percent of the model and systematic dependencies of the deviations are minimal, the differences in test conditions do not contribute significantly to the overall variability.

In addition to the above ranges of test conditions, the complex heat transfer processes in thermal insulations may depend on unquantified specimen and apparatus characteristics. For example, the dependence on plate emittance, fiber diameter, fiber orientation, phenolic content, and shot content is not well known. The test methods generally require a minimum value of 0.8 for plate emittance but the actual measured values are not reported. The fiber diameters, given earlier, are representative for each of the insulations used here, but the variations in fiber diameter among specimens is unknown. The effect of these unquantified characteristics establishes a minimum value below which laboratory variability can not be assessed.

The first task is to estimate the minimum variability due to these unknowns. The total variability is the combined effect of this minimum variability plus intralaboratory (within laboratory, usually meaning the imprecision of a single apparatus) and interlaboratory (between laboratory) variability. To facilitate this analysis, the average deviations and 2s values given in the previous deviation plots are compiled in Table 9.1.

The intralaboratory variability can be estimated from repeat measurements on a given specimen using a single apparatus. Subsets 6/5 and 7/5 contain the bulk of the repeat measurements. The deviations of the data in subset 6/5 are plotted for each specimen in Figure 6.11. These data are actually obtained from two HFM apparatus but the results show them to be indistinguishable. The spread of the data for two of the four specimens is comparable to the spread for all of the specimens combined as shown in Figure 6.10. Thus the intralaboratory variability is estimated as 1.9%. The deviations of the data in subset 7/5 are plotted for each of the eight specimens in Figures 7.11 and 7.12. Again two apparatus were used to obtain these data but they are readily separable. The data plotted for 1978 are taken with one apparatus while all the others with another. A difference of about 1% between the two apparatus is noted. In this case the variability of the results for each apparatus is

Table 9.1 Average Deviations and 2s Values For Selected Subsets and Data For Each of the Round Robins

Date Subset Number	Shown in Figures	Listed in Tables	Participant Numbers	Apparatus Types	Specimen Thickness (cm)	Specimen Density (kg/m ³)	Test Temperatures (k)	Avg. d Dev. %	2s ^e %
5/1	5.8, 5.9, 5.10	5.1, 5.2	13	GHP, LS-GHP	2.54 to 10.2	11 to 34	256 to 327	0.00	1.40
5/2	5.11, 5.13	5.1	13	GHP	2.54	11 to 34	256 to 327	-0.15	1.76
5/3	5.12, 5.14	5.2	13	LS-GHP	2.54 to 10.2	11 to 19	297	0.08	1.18
6/1	6.5	6.1	12, 16, 17	HFM-36	8.9	12 to 14	297	-0.42	2.12
6/2	6.6	6.2	13,14,18,20,21	HFM-24	8.9	12 to 14	297	-1.82	2.68
6/3	6.7	6.3	15, 18	GHP	8.9	12 to 14	297	-1.69	3.55
6/4	6.8	6.1,6.2,6.3	12-18,20,21	HFM, GHP	8.9	12 to 14	297	-1.31	2.92
6/5	6.10	6.4	17	HFM-36,24	8.9	12 to 14	297	-0.40	1.92
7/1	7.5	7.1	11,12,14,17,19	HFM-12,16,24	2.54	10 to 33	297	-0.60	1.73
7/2	7.6	7.2	15, 19	GHP	2.54	10 to 33	297	-1.27	0.52 ^c
7/3	7.7	7.1, 7.2	11,12,14,15,17,19	HFM, GHP	2.54	10 to 33	297	-0.74	1.65 ^c
7/4	7.8	7.5	11,14,17,18	HFM-12,24	2.54 to 5.13	10 to 33	267 to 332	+0.31	1.99
7/5	7.10	7.4	17	HFM-12	2.54	10 to 33	297	-0.90	1.64
8/1	8.3, 8.4	5.2, 8.1	12,13,15,18,22	GHP, LS-GHP	2.54 to 10.2	11 to 19	297	+0.93	2.54
8/2	8.5	5.2, 8.1, 8.2	"	"	2.54	"	"	0.47	1.87
8/3	8.6	5.2, 8.1	"	"	5.08	"	"	1.00	2.34
8/4	8.7	5.2, 8.1	"	"	7.62	"	"	1.41	2.62
8/5	8.8	5.2, 8.1	"	"	10.2	"	"	1.17	2.94
8/6	8.9	5.2, 8.1	"	"	2.54 to 10.2	11	"	0.71	2.43
8/7	8.10	5.2, 8.1	"	"	"	15	"	0.81	2.14
8/8	8.11	5.2, 8.1	"	"	"	19	"	1.18	2.70
8/9	8.3 - 8.11	8.1	12	GHP	2.54 to 10.2	11 to 19	297	1.60	1.01
8/10	8.3 - 8.11	5.2	13	LS-GHP	"	"	"	0.08	1.18
8/11	8.3 - 8.11	8.1	15	GHP	"	"	"	0.41	1.09 ^f
8/12	8.3 - 8.11	8.1	18	GHP	"	"	"	0.90	2.22 ^f
8/13	8.3 - 8.11	8.1	22	GHP	"	"	"	2.43	3.52 ^f

a - The data subset number indicates the section number of this report and/the subset number in that section.

b - Line source GHP.

c - Lab 19 excluded.

d - Average deviation from the model.

e - Two times the standard deviation of the test results with respect to their mean (an approximation of the 95% confidence interval).

f - Equipment difficulties reported

smaller than for subset 6.5, the spread of data for each specimen is about 0.5%. From this we conclude that for laboratory 17 the intralaboratory variability is as high as 1.9% for a thickness of 8.9 cm and about 0.5% for 2.54 cm. The intralaboratory variability for the other laboratories can not be assessed since repeat measurements were not required. The combined effect of intralaboratory variability and unquantified specimen characteristics can be estimated from measurements on a group of specimens by the same laboratory. Again we refer to subsets 6/5 and 7/5. For both of these subsets the spread of values for all specimens is about the same as the spread for each specimen separately. Thus the variability caused by unquantified specimen characteristics appears to be a small portion of the total. Subsets 5/2, 5/3 and 8/9 through 8/13 are also valid for assessing the above combined effects. The 2s values for these subsets range from 1.01 to 3.52%. The two highest values (2.22 and 3.52%) are based on test results that were considered somewhat suspect (due to apparatus difficulties) by the laboratory reporting the results. If these two subsets are ignored the remaining range of 2s values is 1.01 to 1.76%. It is concluded that the combined variability is in the range of 1 to 2%. Consequently interlaboratory comparisons below this 1 to 2% range are not meaningful, i.e., differences below this range are not statistically significant.

9.2 Round Robin I

The objective of RR I was to evaluate the testing community's measurement capabilities for building insulation at thicknesses above which reference standards were available. Reference standards at that time were available only at 2.54 cm thickness. To assess the measurement capability at 2.54 cm thickness we examined data from all of the round robins. The principal subsets at 2.54 cm thickness are 5/2, 7/3, and 8/2. The 2s value for these subsets include a range of density from 10 to 34 kg/m³. The measurement capability at 8.9 cm thickness is represented by the 2s value of 2.92% from subset 6/4. The range of 2s values of the subsets in RR I is 1.92 to 3.55%. Thus, it is concluded that the measurement capability is degraded by about 1% at 8.9 cm thickness as compared to measurement at 2.54 cm thickness. It is noted that the density range for RR I is only 12 to 14 kg/m³.

9.3 Round Robin II

The objective of RR II was to evaluate the testing community's ability to measure building insulations of sufficiently low density where the effect of variability in plate emittance may be significant. This effect would be exhibited by an increase in indicated variability as density decreases. RR II included specimen densities from 10 to 33 kg/m³. Although 2s values were not computed for the four nominal densities involved, it is clear from Figure 7.5 that the spread is not a significant function of density. Subsets 8/6, 8/7, and 8/8 from RR III (2s values of 2.43, 2.14, and 2.70 for densities of 11, 15, and 19 kg/m³, respectively) also confirm this conclusion. RR II, performed nearly entirely at specimen thicknesses of 2.54 cm, exhibited the lowest 2s value, 1.65% overall.

9.4 Round Robin III

The objective of RR III was threefold a) to provide information on the testing community's ability to measure at thicknesses of at least 10.2 cm, b)

to provide helpful information on the evaluation of the new NBS line-source GHP, and c) to establish data on the thickness effect of a low-density insulation. The entire data set from RR III resulted in a 2s value of 2.54% (subset 8/1). This is only about 1% greater than the 2S value for measurement at 2.54 cm. The range of 2s values at thicknesses from 2.54 to 10.2 cm is 1.87 to 2.94%. An increase of about 1% from 2.54 to 10.2 cm is in agreement with the result observed in RR I (subsets 8/2 to 8/5). The 2s values for the five laboratories ranged from 1.01 to 3.52% (subsets 8/9 to 8/13).

Figure 8.3 shows that the NBS line-source GHP produces test results near the lower end of the range of the five laboratories participating in RR III. In addition, Figure 8.4 reveals that the NBS line-source GHP yields a thickness effect near the lower end of the range for the five laboratories. The model described in section 5 is based on the NBS test results. Therefore, the model also yields a thickness effect below that of the average of the participating laboratories. The average thickness effect (change in k_a from 2.54 cm to 10.2 cm) as indicated by all of the data is about 1% greater^a than the model prediction for each of the three nominal densities of RR III.

The thickness effect from 2.54 cm to 10.2 cm as indicated by the RR III data is the sum of that given by the model (see figures 5.17 and 5.20) and the average residual systematic trend exhibited by figures 8.9, 8.10, and 8.11. At a temperature of 300 K, density of 10 kg/m³, fiber diameter of 5.0 μ m, and a plate emittance of 0.9, the indicated thickness effect from 2.54 to 10.2 cm is about 3.3%. Values for other test conditions can, of course, be calculated from the model.

9.5 General Summary

The results of these round robins reveal that, within the range of these test conditions and for this group of participating laboratories, the commonly accepted view that apparent thermal conductivity can be measured to within $\pm 2\%$ is approximately correct. The results also reveal exceptions to this rule as exhibited by the data of laboratory 19 in RR II and to a lesser extent by the data of laboratory 18 and 22 in RR III. The variability of these test results establish lower limits to the precision and bias of the insulation community's measurement capability. These lower limits may be especially significant for the enforcement of energy conservation regulations. These test results will also be valuable as a basis for the precision and bias statements required for ASTM test methods C177 and C518.

The results show that the variability from GHP's and HFM's are comparable and that the size of the plates (within the limits established by the test methods) over the range of this study was not an important factor in the results. The test results also indicate that only moderate degradation in testing capability occurs with increased thickness.

It should be noted that the participants in these round robins have generally exhibited good measurement practices using proven apparatus. The results of this study can not be extended to include all other laboratories in the industry. This can only be done on the basis of similar programs involving a large number of participants.

In addition, a relatively simple model was developed that represented the dependencies of test results from the three round robins to within approximately the imprecision of the whole set of data. The model yields apparent thermal conductivity values as a function of temperature (256 to 332 K), density (10 to 34 kg/m³), thickness (2.54 to 10.2 cm), fiber diameter and plate emittance. This has been a valuable analytical tool for intercomparison of data and may prove useful for future comparisons.

10. RECOMMENDATIONS

As measurement capabilities expand and improve, further round robins will be required to assess the reliability of new apparatus and measurements. The existence of NVLAP and NBS reference materials will aid this self-assessment process.

The present round robin results indicate that the observed variability is caused mainly by apparatus imprecision and bias. The variability caused by unquantified specimen characteristics appears to be a small portion of the total variability. Thus the main emphasis in reducing test result variability should be directed toward apparatus improvements. It is important to recognize that the variability resulting from unknown specimen characteristics in this case was small due largely to the excellent specimen selection and characterization procedures used. As measurement capabilities improve, specimen selection and characterization procedures will become even more crucial, especially for the development of a model which provides a useful tool for data intercomparisons.

A knowledge of certain apparatus characteristics will be helpful to determine and reduce the sources of apparatus variability. For example, measured values for plate emittance may be helpful for low-density insulation specimens. An error analysis for each apparatus, such as that given by Powell and Rennex [16] and Smith, Hust and Van Pollen [17] would aid the analyst. Measurements showing the dependencies of test results on gap and edge temperature unbalances are very informative to both the participant and the analyst. A knowledge of the magnitude of plate temperature non-uniformity and plate temperature drift will assist in establishing some of the apparatus variability. For HFM apparatus the required use of the same reference material for calibration prior to round robin testing would reduce test result variability. Judiciously chosen repeat measurements on the same specimens by each participant would help establish intralaboratory variability.

The effect of unquantified specimen variability is always an important issue to the success of a round robin. For insulations, the main source of unquantified specimen variability is believed to be related to variation in the structure of the matrix (such as fiber diameter distribution, fiber orientation, binder content, shot content, and density distribution). Current technology frequently requires the destruction of the specimen to accurately determine these parameters. The development of alternate means to characterize the effect of those parameters are recommended, e.g., the light transmission technique described by Pelanne [15].

Within the current measurement capabilities the effect of thickness from 2.54 cm to 10.2 cm has been established for the glass fiber insulation used in RR III. Further work needs to be done at greater thicknesses and for other products since the effect of thickness is expected to vary significantly with the optical characteristics of the product.

Although some round robin activities are nearing completion for higher temperatures, further studies will be needed to assess and improve the measurement capabilities at temperatures above 297 K (75°F). Because radiative heat transmission increases approximately as the third power of the mean temperature, a knowledge of the scattering and absorption properties of the specimens and the plate emittance will take on increased significance.

11. ACKNOWLEDGMENTS

The authors, in behalf of the thermal measurement community, wish to express their thanks to each of the participants involved in these round robins. Without their interest, concern and diligence, the information presented here could not have been available for the benefit of all. The authors also wish to express their appreciation for the co-sponsorship of these round robins by ASTM C-16.30 Subcommittee on Thermal Measurements and the Mineral Insulation Manufacturers Association. Appreciation is expressed to the members of the community who provided the materials for these measurements, Owens-Corning Fiberglas Corporation, Manville Corporation, the National Bureau of Standards, and the National Voluntary Laboratory Accreditation Program. The financial assistance of the Department of Energy, Oak Ridge National Laboratory in providing for the completion of this project is gratefully acknowledged.

12. REFERENCES

- [1] ASTM C177, "Standard Test Method For Steady-State Thermal Transmission Properties by Means of the Guarded Hot Plate" ASTM Book of Standards, Section 4, Volume 04.06 (1984).
- [2] ASTM C518, "Standard Test Method for Steady-State Thermal Transmission Properties by Means of the Heat Flow Meter" ASTM Book of Standards, Section 4, Volume 04.06 (1984).
- [3] C.M. Pelanne, "Thermal Insulation Heat Flow Measurements: Requirements for Implementation" ASHRAE Journal, March 1979 pp 51-58.
- [4] C.M. Pelanne, "ASTM and the Technical Community's Response to Conceptual Changes in Thermal Insulation Measurements" ASTM Standardization News, December 1982, pp 19-22.
- [5] H.E. Robinson & T.W. Watson, "Interlaboratory Comparison of Thermal Conductivity Determinations with Guarded Hot Plates" ASTM Special Technical Publication #119, (STP 119), Philadelphia, PA 1951.
- [6] I.I.R, "International Comparative Measurements of Thermal Conductivity" Thermal Insulating Measurements, (Essais D'Insolants Thermiques), Commission II of the International Institute of Refrigeration, Report by the Chairman of the Committee, Carl F. Kayan, 1968.
- [7] I.S.O. "International Thermal Conductance Round Robin" Frank J. Powell, Convener, Working Group 6, Round-Robin Tests Subcommittee 1, ISO 163, Thermal Insulation. Round Robin in progress, almost completed in 1984.
- [8] ASTM C16.30 "Round Robin for Guarded and Calibrated Hot Boxes" E.L. Bales Chairman, Task Force 4.3, Hot Box RR Section 4 - Test Methods for Building Systems, ASTM C-16.30 Round Robin to be reported in March 1985.
- [9] C.M. Pelanne, "The Development of Low-Density Glass-Fiber Insulation as Thermal Transmission Reference Standards" Thermal Conductivity 17, J.G. Hust, Editor, Plenum 1983, pp 763-776.
- [10] B. Rennex, "Low-Density Thermal Insulation Calibrated Transfer Samples- -A Description and a Discussion of the Material Variability" NBSIR 82-2538, NBS, Gaithersburg, MD June 1982.
- [11] D.R. Smith, J.G. Hust & L.J. Van Poolen, "Effective Thermal Conductivity of a glass Fiberblanket Standard Reference Material" NGSIR 81-1640, NBS, Boulder, CO, February 1981.
- [12] M.C.I. Siu, "Fibrous Glass Board as a Standard Reference Material for Thermal Resistance Measurement Systems" (SRM-1450), "Thermal Insulation Performance," ASTM STP 718, American Society for Testing and Materials, Philadelphia, (1980), pp 343-360.
- [13] D.R. Smith & J.G. Hust, "Effective Thermal Conductivity of a Glass Fiberboard Standard Reference Material" (SRM-1450), NBSIR 81-1639, NBS, Boulder CO, February 1981.

- [14] C.M. Pelanne, "Discussion on Experiments to Separate the "Effect of Thickness" from Systematic Equipment Errors in Thermal Transmission Measurements", "Thermal Insulation Performance," ASTM STP 718, American Society for Testing and Materials, Philadelphia, (1980), pp 322-334.
- [15] C.M. Pelanne, "Light Transmission Measurements Through Glass Fiber Insulations", "Thermal Transmission Measurements of Insulations," ASTM STP 660, American Society for Testing and Materials, Philadelphia, (1978), pp 263-280.
- [16] F.J. Powell and B.G. Rennex, "The NBS Line-Heat-Source Guarded Hot Plate for Thick Materials", Proceedings of the ASHRAE/DOE Conference, Thermal Performance of the Exterior Envelopes of Buildings II, ASHRAE SP38, ASHRAE, Atlanta, GA, 1983, pp. 657-672.
- [17] D.R. Smith, J.G. Hust, and L.J. Van Poolen, "A Guarded-Hot-Plate Apparatus for Measuring Effective Thermal Conductivity of Insulations Between 80 and 360 K," NBSIR 81-1657, NBS, Boulder, CO, December 1981.
- [18] M. Albers, Manville Research and Development Center, Denver, Colorado (Private Communication).
- [19] M.B. Lacher, Owens-Corning Fiberglas Corp., Granville, Ohio.
- [20] S.H. Cady, Mineral Insulation Manufacturers Association, Summit, New Jersey.

13. APPENDIX*

Figure 13.1 shows a description of the samples for the round robins. Fig. 13.2 shows the standardized reference values for the RR II samples (as prepared for participants).

Table 13.1 lists the participants and reviewers for this round robin study.

To conveniently tabulate the extensive information for these round robin studies a coding scheme was necessary. The coding methodology for the tables is given in Table 13.2.

Table 13.3 shows the data form used for reporting the round robin test results.

Tables 13.4 through 13.6 lists the measured weights and calculated densities for each cut size of the specimens for round robin I, II and III, respectively.

Tables 13.5.1 through 13.8.3 list the data from each of the round robins in the units originally reported.

*The data reported in the tables and figures of the appendix are in units customary to the insulation industry and as reported by the participants of these round robins. It is noted that these units are not consistent with normal NBS usage.

DESCRIPTION OF SAMPLES FOR ROUND ROBIN

R R No. 1 - Samples 15 x 48 x 3.5-in.

Test Design as run by J-M for Illustration

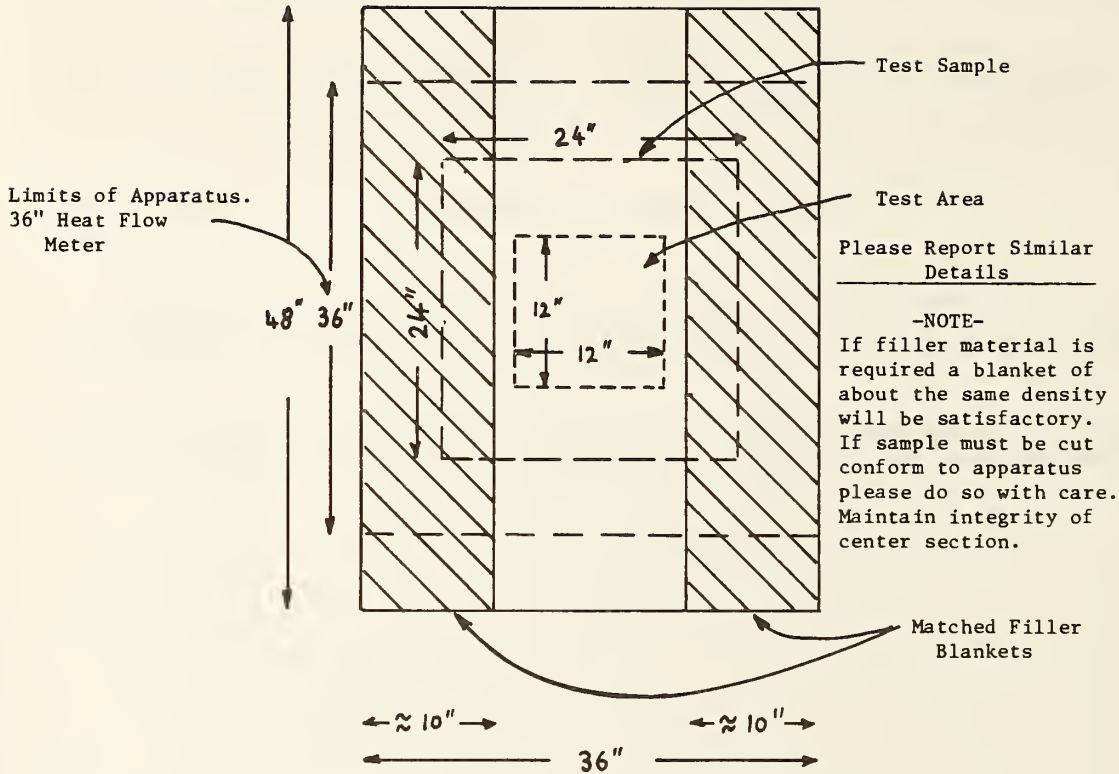

R R No. 2 - Samples 24 x 24 x 1-in.

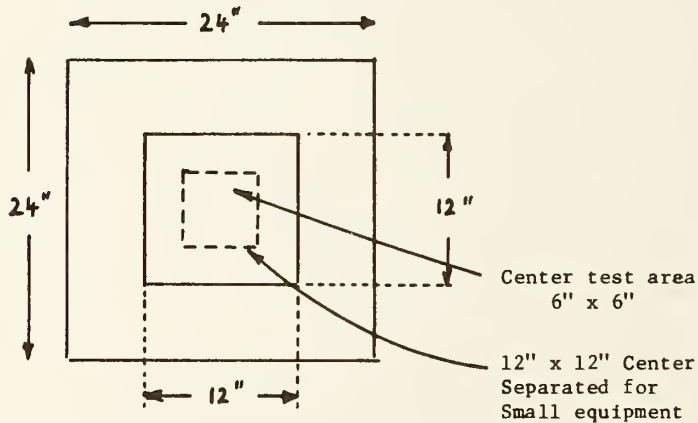

-NOTE-

The total sample is 24 x 24 inch with a center 12 x 12-in. section separated for testing in small equipment. If the sample must be cut further please do it --- so as to maintain the sample integrity. If needed, consult with C. M. Pelanne.

Figure 13.1 Description of Samples for Round Robin.

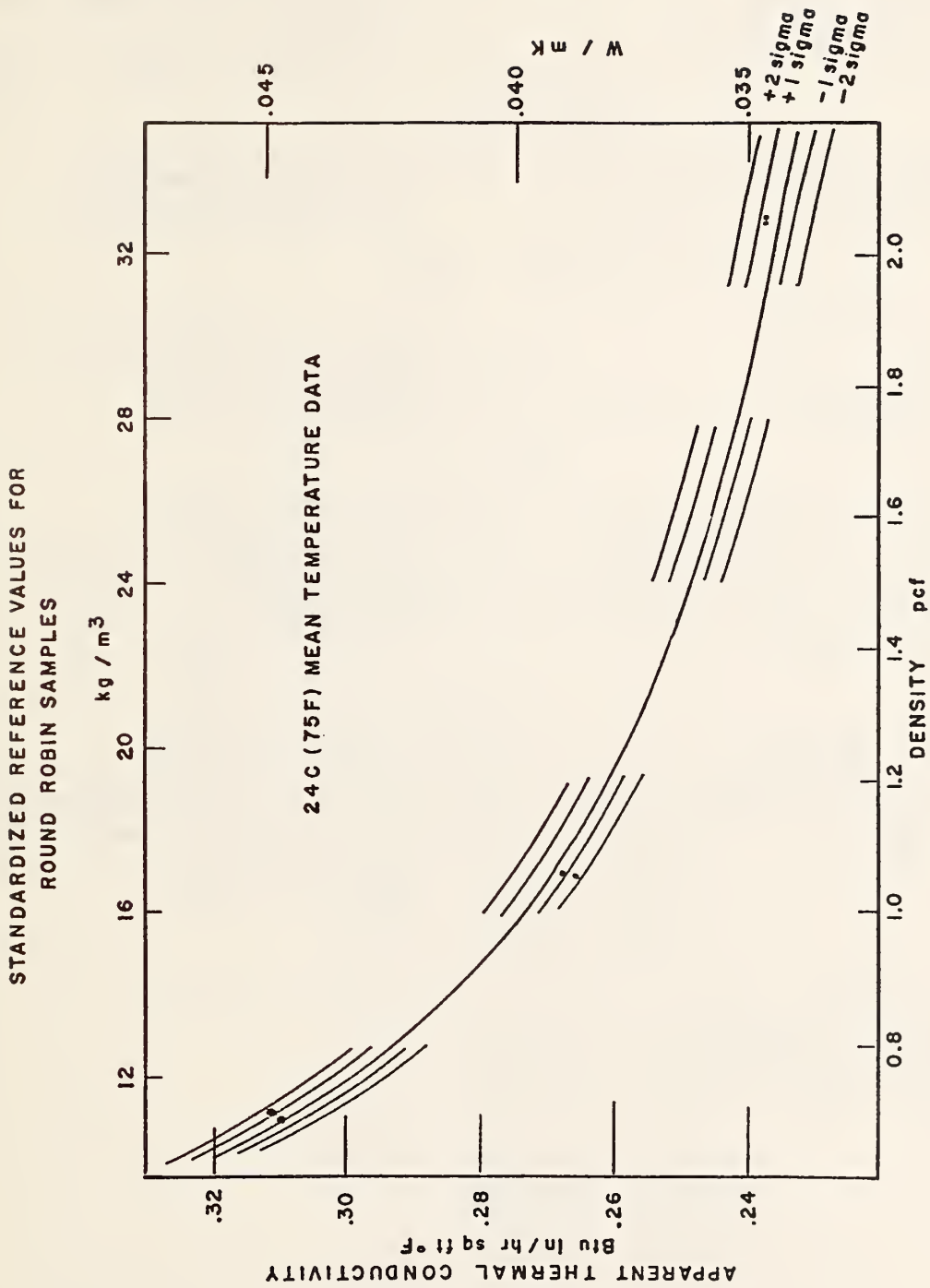

Figure 13.2 Standardized Reference Values for the Round Robin II Samples.

Table 13.1 ASTM C-16.30/MIMA Round Robins.
Participants and Reviewers

Dr. Mark Bomberg
National Research Council
Division of Building Research
Ottawa, Ont. Canada K1A 0R6

Dr. David L. McElroy
Oak Ridge National Laboratory
P.O. Box X
Oak Ridge, TN 37830

Mr. Sheldon H. Cady
Mineral Insulation Mfgs. Assn.
382 Springfield Avenue, Suite 312
Summit, NJ 07901

Dr. Gerry R. Miller
Jim Walter Research Corp.
10301 9th Street North
St. Petersburg, FL 33702

Mr. Andre O. Desjarlais
Mr. R.P. Tye
Dynatech R/D Company
99 Erie Street
Cambridge, MA 02139

Dr. Benjamin Mosier, Pres.
Institute for Research, Inc.
8330 Westglen Drive
Houston, TX 77063

Mr. William M. Edmunds
Mr. M. Lacher
Owens-Corning Fiberglas Corporation
Technical Center
P.O. Box 415
Granville, OH 43023

Mr. Frank J. Powell
Dr. Brian Rennex
National Bureau of Standards
USG Commerce
Gaithersburg, MD 20899

Mr. Stanley L. Matthews
Mr. Jesse L. Bridwell
Rockwool Industries Inc.
P.O. Box 5170
Denver, CO 80217

Mr. Charles Pelanne
Mr. Richard Troyer
Manville Service Corporation
Research and Development Center
P.O. Box 5108
Denver, CO 80217

Dr. David J. McCaa
Mr. Joseph F. Kimpflen
Certain-Teed Corporation
1400 Union Meeting Road
Blue Bell, PA 19422

Table 13.2 ASTM C-16.30/MIMA Round Robins.
Coding Methodology

Table Column	<u>Identification</u>
1	Round robin phase: I,II,III or NBS: (1,2,3,4)
2-3	Participant: 11,12,13,14,15,16,17,18,19,20,21,22
4-7	Date: Month/Year
8-12	Equipment: digit 8 - G=GHP, H=HFM " 9&10 - Overall size (inches) 11&12 - Test Area Size (inches)
13-15	Testing code: Col. 13 testing combination id. as follows; 1 = specimen tested as one 2 = 1 pair of specimens, specimens, average value 3 = stacked pair w/o septum 4 = " " w/septum 5 = 1 pair of specimens, average, RR III 6 = 2 pairs of specimen, average, RR III 7 = 3 pairs of specimens, average, RR III 8 = 4 pairs of specimens, average, RR III Cols. 14 & 15 density identification coded as follows: Phase I; 08 Phase II; 05, 10, 15, 20 Phase III; 07, 09, 12 NBS Refer; 06, 11, 16, 21
16-20	Specimen identification number: specimen number (X), Phase I; (8)=1, (9)=3, (10)=2, (11)=4 as pairs; (8+9)=1 (10+11)=2 Phase II; set 05: (04)=1, (09)=5 set 10: (18)=2, (24)=6 set 15: (49)=3, (50)=7 set 20: (14)=4, (15)=8 Phase III; set 07; level 1; (81247)=1, (50138)=5 " 2; (82278)=2, (50975)=6 " 3; (50134)=3, (50533)=7 " 4; (81257)=4, (61663)=8 set 09; level 1; (80831)=1, (81065)=5 " 2; (80914)=2 (80738)=6 " 3; (80762)=3 (80874)=7 " 4; (85855)=4, (85545)=8 set 12; level 1; (11931)=1, (11761)=5 " 2; (11141)=2, (11911)=6 " 3; (12115)=3, (10155)=7 " 4; (10615)=4, (11575)=8 note; when tested as pairs 1 = 1 & 5, 2 = 2 & 6

Phase II (NBS);
Specimen Identification Code.

Series	Density	Pair 1		Pair 2	
0500	06	10 =(1)	+17 =(3)	32 =(2)	+36 =(4)
1000	11	11 =(1)	+10 =(3)	33 =(2)	+35 =(4)
1500	16	13 =(1)	+52 =(3)	54 =(2)	+62 =(4)
2000	21	35 =(1)	+37 =(3)	06 =(2)	+09 =(4)
21-25	Test thickness in inches				
26-30	Test area density in lb/ft ³				
31-35	Hot face temperature in °F				
36-40	Cold face temperature in °F				
41-45	Mean temperature in °F				
46-51	Apparent thermal conductivity in Btu·in/h·ft ² ·°F				
52-57	Footnotes as required				

TABLE 13.3 Typical Data Form used for Reporting Test Results.

NMWIA - Round Robin - Mean Temperature - 75°F
Appliance Insulation Test Results

Laboratory Name:

Date of Tests:

Apparatus Description:

Operator:

Reporter:

TEST RESULTS

Nominal Density, pcf

0.7

1.0

Sample Identification
Number

0500-4

0500-9

1000-18

1000-24

Density, pcf

Measurement Area:

Thickness, inch:

1.0

1.0

1.0

1.0

Hot Surface °F

Cold Surface °F

Mean Temperature °F

Apparent Thermal
Conductivity

COMMENTS:

TABLE 13.4 Specimen Sizes, Weights, and Densities for Round Robin I.

Specimen Sizes (in)	15.25×24.0	16×16*	12×12	10×10
Specimen 8(1)				
Weight (g)	261.47	189.53	108.70	74.08
Density (lb/ft ³)	0.778	0.806	0.822	0.806
Specimen 9(3)				
Weight (g)	283.24	195.68	116.48	83.47
Density (lb/ft ³)	0.842	0.832	0.880	0.909
Specimen 10(2)				
Weight (g)	244.54	181.19	103.44	71.20
Density (lb/ft ³)	0.727	0.770	0.782	0.775
Specimen 11(4)				
Weight (g)	259.68	184.21	109.30	78.99
Density (lb/ft ³)	0.772	0.783	0.826	0.860

*Adjusted from 15.25×16 measurement

TABLE 13.5 Specimen Sizes, Weights, and Densities for Round Robin II.

Specimen Sizes (in)	24×24	18×18	12×12	10×10	8×8	6×6	4×4
Set 05							
Specimen 04(1)							
Weight	99.52	57.20	25.50	17.98	11.44	6.25	2.85
Density	0.658	0.673	0.675	0.685	0.681	0.661	0.697
Specimen 09(5)							
Weight	103.47	58.07	25.13	17.54	11.17	6.35	2.82
Density	0.684	0.683	0.665	0.668	0.665	0.672	0.671
Set 10							
Specimen 18(2)							
Weight	158.03	88.80	39.10	27.28	18.12	10.38	4.78
Density	1.045	1.044	1.037	1.039	1.079	1.098	1.138
Specimen 24(6)							
Weight	163.20	90.00	39.77	28.07	18.22	10.53	4.53
Density	1.079	1.058	1.052	1.069	1.085	1.114	1.079
Set 15							
Specimen 49(3)							
Weight*	283.14	137.24	59.98	42.10	27.36	15.28	7.08
Density**	1.575	1.614	1.587	1.604	1.629	1.617	1.686
Specimen 50(7)							
Weight	240.96	135.58	59.85	41.80	26.79	14.50	6.82
Density	1.594	1.594	1.583	1.592	1.595	1.534	1.624
Set 20							
Specimen 14(4)							
Weight	313.32	173.72	77.12	53.93	35.19	19.18	8.77
Density	2.072	2.043	2.040	2.054	2.095	2.095	2.088
Specimen 15(8)							
Weight	314.65	174.65	76.82	53.27	33.50	19.12	8.68
Density	2.081	2.054	2.032	2.029	1.994	2.023	2.067

*Weight in grams

**Density in lb/ft³

TABLE 13.6 Specimen Sizes, Weights, and Densities for Round Robin III.

Specimen Sizes(in)	24×24 weight	24×24 density	18×18 weight	18×18 density	16×16 weight	16×16 density	12×12 weight	12×12 density	16 DIA density
Set 07									
81247(1)	105.2	0.729	61.50	0.723	49.33	0.734	27.98	0.740	0.737
50138(5)	103.4	0.715	61.48	0.723	49.25	0.732	27.93	0.739	0.735
82278(2)	103.7	0.719	60.23	0.708	48.05	0.714	27.27	0.721	0.718
50975(6)	102.7	0.716	59.81	0.703	46.61	0.693	25.10	0.664	0.678
50134(3)	101.4	0.699	61.16	0.719	48.89	0.727	27.97	0.740	0.733
50533(7)	101.1	0.707	59.97	0.705	47.55	0.707	26.55	0.702	0.705
81257(4)	102.7	0.712	60.15	0.707	47.87	0.712	26.94	0.712	0.712
61663(8)	102.3	0.710	59.35	0.697	46.28	0.688	25.27	0.668	0.678
Set 09									
80831(1)	147.96	0.978	83.90	0.986	66.70	0.992	36.87	0.975	0.984
81065(5)	148.10	0.979	82.70	0.972	65.08	0.968	35.37	0.935	0.952
80914(2)	149.36	0.987	83.90	0.986	66.27	0.986	36.96	0.977	0.982
80738(6)	148.13	0.979	83.25	0.979	66.72	0.992	37.06	0.980	0.986
80762(3)	148.79	0.983	83.13	0.977	65.75	0.978	36.68	0.970	0.974
80874(7)	148.00	0.978	83.52	0.982	66.50	0.989	38.11	1.008	0.998
85855(4)	145.76	0.963	83.18	0.978	65.45	0.973	36.63	0.969	0.971
85545(8)	148.58	0.982	80.83	0.950	64.10	0.953	35.25	0.932	0.943
Set 12									
11931(1)	180.56	1.193	103.05	1.211	81.90	1.218	45.17	1.195	1.206
11761(5)	181.73	1.201	103.00	1.211	81.03	1.205	45.45	1.202	1.204
11141(2)	175.54	1.160	99.56	1.170	78.60	1.169	42.81	1.132	1.151
11911(6)	177.14	1.170	100.00	1.176	79.39	1.181	44.83	1.186	1.183
12115(3)	191.95	1.268	113.0	1.269	89.5	1.296	50.3	1.297	1.296
10115(7)	182.00	1.203	102.72	1.207	81.45	1.211	46.20	1.222	1.217
10615(4)	173.22	1.144	100.41	1.180	79.98	1.190	44.78	1.184	1.187
11575(8)	177.10	1.170	101.00	1.188	81.10	1.206	45.55	1.205	1.206

Table 13.5.1 ASTM C-16.30/MIMA Round Robins. National Bureau of Standards Test Results.
Reference Base for Calibrated Specimens used for Round Robin II.

RR NO.	LAB NO.	DATE M Y	EQUIP TYPE	TEST COND.	SPEC. NO.	THICK. in	DENS. lb/ft ³	HOT TEMP	COLD TEMP	MEAN TEMP	k "Btu"	FOOT-NOTES
II 13	13	0574	G0804	206	1	1.00	0.68	20.7	-17.9	1.4	0.236	p
II 13	13	0574	G0804	206	1	1.00	0.68	97.5	53.1	75.3	0.308	p
II 13	13	0574	G0804	206	1	1.00	0.68	151.2	107.2	129.2	0.372	p
II 13	13	0574	G0804	206	2	1.00	0.71	97.5	53.2	75.4	0.310	p
II 13	13	0574	G0804	211	1	1.00	1.11	97.3	53.3	75.3	0.268	p
II 13	13	0574	G0804	211	2	1.00	1.07	97.2	53.2	75.2	0.269	p
II 13	13	0574	G0804	216	1	1.00	1.57	21.0	-18.2	1.4	0.202	p
II 13	13	0574	G0804	216	1	1.00	1.57	97.6	53.2	75.4	0.248	p
II 13	13	0574	G0804	216	1	1.00	1.57	149.7	108.5	129.1	0.288	p
II 13	13	0574	G0804	221	2	1.00	1.65	97.3	53.1	75.2	0.243	p
II 13	13	0574	G0804	221	1	1.00	2.07	97.3	53.3	75.3	0.235	p
II 13	13	0574	G0804	221	2	1.00	2.15	97.2	53.2	75.2	0.235	p

"Btu" = Btu·in/h·ft²·°F

p: Specimens tested in pairs. Given values are the average.

Table 13.5.2 ASTM C-16.30/MIMA Round Robins. National Bureau of Standards Data for Round Robin III.

RR NO.	LAB NO.	DATE M Y	EQUIP TYPE	TEST COND.	SPEC. NO.	THICK. in	DENS. lb/ft ³	HOT TEMP	COLD TEMP	MEAN TEMP	k "Btu"	FOOT-NOTES
III 13	III 13	0882	G4016	507	1	1.00	0.736	100.0	50.0	75.0	0.300	1s
III 13	III 13	0882	G4016	607	12	2.00	0.717	100.1	50.1	75.1	0.303	1s
III 13	III 13	0882	G4016	707	123	3.00	0.718	100.0	50.0	75.0	0.303	1s
III 13	III 13	0882	G4016	807	1234	4.00	0.712	100.0	50.0	75.0	0.304	1s
III 13	III 13	0882	G4016	509	1	1.00	0.968	99.9	50.1	75.0	0.273	1s
III 13	III 13	0882	G4016	609	12	2.00	0.976	100.0	50.1	75.1	0.276	1s
III 13	III 13	0882	G4016	709	123	3.00	0.979	100.0	49.9	75.0	0.276	1s
III 13	III 13	0882	G4016	809	1234	4.00	0.974	99.9	49.9	74.9	0.276	1s
III 13	III 13	0882	G4016	512	1	1.00	1.205	99.9	49.8	74.9	0.260	1s
III 13	III 13	0882	G4016	612	12	2.00	1.186	100.0	50.0	75.0	0.262	1s
III 13	III 13	0882	G4016	712	123	3.00	1.210	100.0	50.0	75.0	0.261	1s
III 13	III 13	0882	G4016	812	1234	4.00	1.206	99.9	49.9	74.9	0.262	1s
III 13	III 13	0882	G4016	507	2	1.00	0.698	100.0	50.0	75.0	0.300	1s i
III 13	III 13	0882	G4016	507	3	1.00	0.719	100.0	50.0	75.0	0.295	1s i
III 13	III 13	0882	G4016	507	4	1.00	0.695	100.0	50.0	75.0	0.300	1s i
III 13	III 13	0882	G4016	807	1234	4.00	0.712	100.0	50.0	75.0	0.304	1s i
III 13	III 13	0882	G4016	807	1234	4.00	0.712	100.0	50.0	75.0	0.304	1s i
III 13	III 13	0882	G4016	509	2	1.00	0.984	100.0	50.0	75.0	0.274	1s i
III 13	III 13	0882	G4016	509	3	1.00	0.986	100.0	50.0	75.0	0.271	1s i
III 13	III 13	0882	G4016	509	4	1.00	0.957	100.0	50.0	75.0	0.277	1s i
III 13	III 13	0882	G4016	512	2	1.00	1.167	100.0	50.0	75.0	0.264	1s i
III 13	III 13	0882	G4016	512	3	1.00	1.257	100.0	50.0	75.0	0.257	1s i
III 13	III 13	0882	G4016	512	4	1.00	1.196	100.0	50.0	75.0	0.261	1s i

"Btu" = Btu·in/h·ft²·°F

1s: Line source guarded hot plate-circular

i: Temperature not given, assumed on basis of others.

Table 13.6.1 ASTM C-16.30/MIMA Round Robins. Data from the 915-406 mm and 915-305 mm Heat Flow Meter Apparatus for Round Robin I.

RR NO.	LAB NO.	DATE M Y	EQUIP TYPE	TEST COND.	SPEC. NO.	THICK. in	DENS. lb/ft ³	HOT TEMP	COLD TEMP	MEAN TEMP	k "Btu"	FOOT-NOTES
I 12	12	0976	H3616	108	1	3.50	0.806	95.0	55.0	75.0	0.293	s
I 12	12	0976	H3616	108	3	3.50	0.832	95.0	55.0	75.0	0.288	s
I 12	12	0976	H3616	108	2	3.50	0.770	95.0	55.0	75.0	0.296	s
I 12	12	0976	H3616	108	4	3.50	0.783	95.0	55.0	75.0	0.292	s
I 16	16	0677	H3612	108	1	3.50	0.822	101.3	50.2	75.8	0.294	
I 16	16	0677	H3612	108	3	3.50	0.880	101.3	50.2	75.8	0.289	
I 16	16	0677	H3612	108	2	3.50	0.782	101.2	50.3	75.8	0.298	
I 16	16	0677	H3612	108	4	3.50	0.826	101.4	50.3	75.9	0.297	
I 17	17	0976	H3612	108	1	3.50	0.822	95.3	55.2	75.3	0.286	
I 17	17	0976	H3612	108	1	3.50	0.822	94.8	55.0	74.9	0.288	
I 17	17	1076	H3612	108	3	3.50	0.880	95.2	54.6	74.9	0.286	
I 17	17	1076	H3612	108	3	3.50	0.880	95.8	54.8	75.3	0.286	
I 17	17	1076	H3612	108	3	3.50	0.880	95.0	54.8	74.9	0.284	
I 17	17	1076	H3612	108	2	3.50	0.782	95.2	55.2	75.2	0.295	
I 17	17	1076	H3612	108	2	3.50	0.782	95.0	55.0	75.0	0.298	
I 17	17	1076	H3612	108	4	3.50	0.826	95.1	55.2	75.2	0.296	

S: Start of program
 "Btu" = Btu·in/h·ft²·°F

Table 13.6.2 ASTM C-16.30/MIMA Round Robins. Data from 610-254 mm Heat Flow Meter Apparatus for Round Robin I.

RR NO.	LAB NO.	DATE M Y	EQUIP TYPE	TEST COND.	SPEC. NO.	THICK. in	DENS. lb/ft ³	HOT TEMP	COLD TEMP	MEAN TEMP	k "Btu"	FOOT-NOTES
I 13	13	0778	H2410	108	1	3.50	0.806	101.2	51.0	76.1	0.293	
I 13	13	0778	H2410	108	3	3.50	0.909	101.3	50.4	75.9	0.283	
I 13	13	0778	H2410	108	2	3.50	0.775	101.1	50.5	75.8	0.296	
I 13	13	0778	H2410	108	4	3.50	0.860	101.2	50.5	75.9	0.290	
I 14	14	0578	H2410	108	1	3.50	0.806	100.2	50.4	75.3	0.294	
I 14	14	0578	H2410	108	3	3.50	0.909	100.4	50.4	75.4	0.280	
I 14	14	0578	H2410	108	2	3.50	0.775	100.5	50.6	75.5	0.293	
I 14	14	0578	H2410	108	4	3.50	0.860	100.5	50.7	75.6	0.284	
I 18	18	0447	H2410	108	1	3.50	0.806	100.9	50.5	75.7	0.290	
I 18	18	0477	H2410	108	2	3.50	0.755	100.6	50.4	75.5	0.291	
I 18	18	79	H2410	108	1	3.50	0.806	100.5	50.5	75.5	0.284	
I 18	18	79	H2410	108	3	3.50	0.909	101.1	50.5	75.8	0.274	
I 18	18	79	H2410	108	2	3.50	0.775	101.9	50.4	76.2	0.287	
I 18	18	79	H2410	108	4	3.50	0.860	101.1	50.5	75.8	0.276	
I 20	20	1077	H2410	108	1	3.50	0.806	99.5	49.9	74.7	0.288	c
I 20	20	1077	H2410	108	3	3.50	0.909	99.5	49.8	74.7	0.281	c
I 20	20	1077	H2410	108	2	3.50	0.775	99.5	49.9	74.7	0.292	c
I 20	20	1077	H2410	108	4	3.50	0.860	99.5	49.8	74.7	0.285	c
I 21	21	1177	H2410	108	1	3.50	0.806	100.1	51.2	75.7	0.291	
I 21	21	1177	H2410	108	3	3.50	0.909	100.0	51.2	75.6	0.281	
I 21	21	1177	H2410	108	2	3.50	0.775	100.1	51.5	75.8	0.293	
I 21	21	1177	H2410	108	4	3.50	0.860	100.2	51.6	75.9	0.287	

c: The data were calculated on the basis of two reference bases. The second constant yielded k_a values 2% greater than those listed.
 "Btu" = Btu·in/h·ft²·°F

Table 13.6.3 ASTM C-16.30/MIMA Round Rboins. Data from the Guarded Hot Plate Apparatus for Round Robin I.

RR NO.	LAB NO.	DATE M Y	EQUIP TYPE	TEST COND.	SPEC. NO.	THICK. in	DENS. lb/ft ³	HOT TEMP	COLD TEMP	MEAN TEMP	k "Btu"	FOOT-NOTES
I	15	0877	G2412	208	1	3.50	.851	94.9	54.9	74.9	0.282	
I	15	0877	G2412	208	2	3.50	.804	94.9	54.9	74.9	0.288	
I	15	0877	G1812	208	1	3.50	.851	95.0	54.9	75.0	0.281	
I	15	0877	G1812	208	2	3.50	.804	94.8	54.8	74.8	0.286	
I	18	0477	G2412	208	1	3.50	.851	95.9	53.4	74.7	0.293	
I	18	0477	G2412	208	2	3.50	.804	98.1	55.2	76.7	0.298	
I	18	79	G2412	208	1	3.50	.851	100.3	50.0	75.2	0.286	a
I	18	79	G2412	208	2	3.50	.804	99.9	50.2	75.1	0.285	a

a: Equipment rebuilt between two sets of data.
 "Btu" = Btu·in/h·ft²·°F

Table 13.6.4 ASTM C-16.30/MIMA Round Robins. Data from Lab 17 over the Time Period from 1976 to 1980 for Round Robin I.

RR NO.	LAB NO.	DATE M Y	EQUIP TYPE	TEST COND.	SPEC. NO.	THICK. in	DENS. lb/ft ³	HOT TEMP	COLD TEMP	MEAN TEMP	K "Btu"	FOOT-NOTES
I 17	17	0976	H3612	108	1	3.50	0.822	95.3	55.2	75.3	0.286	
I 17	17	0976	H3612	108	1	3.50	0.822	94.8	55.0	74.9	0.288	
I 17	17	1076	H3612	108	3	3.50	0.880	95.2	54.6	74.9	0.286	
I 17	17	1076	H3612	108	3	3.50	0.880	95.8	54.8	75.3	0.286	
I 17	17	1076	H3612	108	3	3.50	0.880	95.0	54.8	74.9	0.284	
I 17	17	1076	H3612	108	2	3.50	0.782	95.2	55.2	75.2	0.295	
I 17	17	1076	H3612	108	2	3.50	0.782	95.0	55.0	75.0	0.298	
I 17	17	1076	H3612	108	4	3.50	0.826	95.1	55.2	75.2	0.296	
I 17	17	0277	H3612	108	1	3.50	0.822	95.0	55.0	75.0	0.288	
I 17	17	0277	H3612	108	3	3.50	0.880	95.0	55.0	75.0	0.284	
I 17	17	0277	H3612	108	2	3.50	0.782	95.0	55.0	75.0	0.296	
I 17	17	0277	H3612	108	4	3.50	0.826	95.0	55.0	75.0	0.287	
I 17	17	0178	H3612	108	1	3.50	0.822	94.7	55.3	75.0	0.293	
I 17	17	0178	H3612	108	3	3.50	0.880	94.8	55.1	75.0	0.286	
I 17	17	0178	H3612	108	2	3.50	0.782	94.9	55.2	75.1	0.295	
I 17	17	0178	H3612	108	4	3.50	0.826	95.1	54.9	75.0	0.292	
I 17	17	0378	H2410	108	1	3.50	0.806	99.6	50.1	47.9	0.297	
I 17	17	0378	H2410	108	1	3.50	0.806	99.6	50.0	74.8	0.297	
I 17	17	0378	H2410	108	3	3.50	0.909	99.8	50.2	75.0	0.285	
I 17	17	0378	H2410	108	3	3.50	0.909	99.8	50.1	75.0	0.285	
I 17	17	0378	H2410	108	2	3.50	0.775	99.7	50.2	75.0	0.299	
I 17	17	0378	H2410	108	2	3.50	0.775	99.7	50.1	74.9	0.301	
I 17	17	0378	H2410	108	4	3.50	0.860	99.8	50.2	75.0	0.288	
I 17	17	0378	H2410	108	4	3.50	0.860	99.8	50.1	75.0	0.289	
I 17	17	0680	H2410	108	1	3.50	0.806	99.9	50.0	75.0	0.290	
I 17	17	0680	H2410	108	3	3.50	0.909	99.9	50.0	75.0	0.281	
I 17	17	0680	H2410	108	2	3.50	0.775	100.0	50.0	75.0	0.294	
I 17	17	0680	H2410	108	4	3.50	0.860	100.1	50.0	75.1	0.284	

"Btu" = Btu·in/h·ft²·°F

Table 13.7.1 ASTM C-16.30/MIMA Round Robins. Data from Heat Flow Meter Apparatus for Round Robin II.

RR NO.	LAB NO.	DATE M Y	EQUIP TYPE	TEST COND.	SPEC. NO.	THICK. in	DENS. lb/ft ³	HOT TEMP	COLD TEMP	MEAN TEMP	K "Btu"	FOOT-NOTES
II 11	11	1278	H1204	105	1	1.00	0.679	95.2	55.5	75.4	0.309	
II 11	11	1078	H1204	105	5	1.00	0.671	94.9	54.7	74.8	0.306	
II 11	11	1078	H1204	110	2	1.00	1.138	95.0	54.9	75.0	0.263	
II 11	11	1078	H1204	110	6	1.00	1.079	94.8	54.9	74.9	0.264	
II 11	11	1278	H1204	115	3	1.00	1.686	95.2	55.1	75.2	0.243	
II 11	11	1078	H1204	115	7	1.00	1.624	95.0	54.9	75.0	0.246	
II 11	11	1278	H1204	120	4	1.00	2.088	95.0	55.1	75.1	0.238	
II 11	11	1078	H1204	120	8	1.00	2.067	95.0	55.3	75.2	0.239	
II 12	12	0577	H1608	205	15	1.00	0.673	95.0	55.0	75.0	0.309	P
II 12	12	0577	H1608	210	26	1.00	1.082	95.0	55.0	75.0	0.269	P
II 12	12	0577	H1608	215	37	1.00	1.612	95.0	55.0	75.0	0.246	P
II 12	12	0577	H1608	220	48	1.00	2.045	95.0	55.0	75.0	0.236	P
II 14	14	0478	H2410	105	1	1.00	0.685	96.2	51.0	73.6	0.311	
II 14	14	0478	H2410	105	5	1.00	0.668	96.1	51.1	73.6	0.309	
II 14	14	0478	H2410	110	2	1.00	1.039	97.0	50.9	74.0	0.269	
II 14	14	0478	H2410	110	6	1.00	1.069	97.0	50.9	74.0	0.267	
II 14	14	0478	H2410	115	3	1.00	1.604	97.4	50.7	74.1	0.244	
II 14	14	0478	H2410	115	7	1.00	1.592	97.3	50.8	74.1	0.245	
II 14	14	0478	H2410	120	4	1.00	2.054	97.4	50.8	74.1	0.230	
II 14	14	0478	H2410	120	8	1.00	2.029	97.5	50.8	74.2	0.236	
II 17	17	0277	H1206	105	1	1.00	0.661	100.0	50.0	75.0	0.309	
II 17	17	0277	H1206	105	5	1.00	0.672	100.0	50.0	75.0	0.308	
II 17	17	0277	H1206	110	2	1.00	1.098	100.0	50.0	75.0	0.265	
II 17	17	0277	H1206	110	6	1.00	1.114	100.0	50.0	75.0	0.266	
II 17	17	0277	H1206	115	3	1.00	1.617	100.0	50.0	75.0	0.245	
II 17	17	0277	H1206	115	7	1.00	1.534	100.0	50.0	75.0	0.245	
II 17	17	0277	H1206	120	4	1.00	2.030	100.0	50.0	75.0	0.236	
II 17	17	0277	H1206	120	8	1.00	2.023	100.0	50.0	75.0	0.236	
II 18	18	0377	H2410	105	1	1.00	0.685	95.3	50.5	72.9	0.306	
II 18	18	0377	H2410	105	5	1.00	0.668	95.5	50.3	72.9	0.308	
II 18	18	0377	H2410	110	2	1.00	1.039	95.4	50.4	72.9	0.269	
II 18	18	0377	H2410	115	7	1.00	1.592	95.5	50.5	73.0	0.243	
II 18	18	0377	H2410	120	8	1.00	2.029	95.6	50.4	73.0	0.233	
II 18	18	0377	H1204	105	1	1.00	0.679	89.7	55.3	72.5	0.310	
II 18	18	0377	H1204	110	2	1.00	1.138	90.0	55.8	72.9	0.267	
II 18	18	0377	H1204	115	7	1.00	1.624	90.1	55.1	72.6	0.243	
II 18	18	0377	H1204	120	8	1.00	2.067	90.1	54.9	72.5	0.238	

p: Specimens tested in pairs. Given values are the average.

"Btu" = Btu·in/h·ft²·°F

Table 13.7.2 ASTM C-16.30/MIMA Round Robins. Data from Guarded Hot Plate Apparatus for Round Robin II.

RR NO.	LAB NO.	DATE M Y	EQUIP TYPE	TEST COND.	SPEC. NO.	THICK. in	DENS. lb/ft ³	HOT TEMP	COLD TEMP	MEAN TEMP	K "Btu"	FOOT-NOTES
II	15	0877	G1206	205	15	1.00	0.666	94.9	54.9	74.9	0.309	
II	15	0877	G1206	210	26	1.00	1.108	95.1	54.9	75.0	0.265	
II	15	0877	G1206	215	37	1.00	1.576	95.0	54.9	75.0	0.244	
II	15	0877	G1206	220	48	1.00	2.026	95.3	54.9	75.1	0.235	
II	15	0877	G1812	205	15	1.00	0.670	95.2	55.1	75.2	0.307	
II	15	0877	G1812	210	26	1.00	1.044	95.0	55.1	75.1	0.268	
II	15	0877	G1812	215	37	1.00	1.585	94.8	55.1	75.0	0.244	
II	15	0877	G1812	220	48	1.00	2.030	94.9	55.1	75.0	0.235	
II	15	0877	G2412	205	15	1.00	0.670	95.2	55.1	75.2	0.307	
II	15	0877	G2412	220	48	1.00	2.036	95.0	55.0	75.0	0.235	
II	19	1078	G	105	1	1.00	0.675	80.0	40.0	60.0	0.271	g h
II	19	1078	G	105	5	1.00	0.675	80.0	40.0	60.0	0.265	g h
II	19	1078	G	110	2	1.00	1.080	80.0	40.0	60.0	0.230	g h
II	19	1078	G	110	6	1.00	1.080	80.0	40.0	60.0	0.233	g h
II	19	1078	G	115	3	1.00	1.590	80.0	40.0	60.0	0.210	g h
II	19	1078	G	115	7	1.00	1.590	80.0	40.0	60.0	0.211	g h
II	19	1078	G	120	4	1.00	2.035	80.0	40.0	60.0	0.205	g h
II	19	1078	G	120	8	1.00	2.035	80.0	40.0	60.0	0.206	g h

g: No apparatus size provide.

h: Only mean temperature given, hot and cold assumed.

"Btu" = Btu·in/h·ft²·°F

Table 13.7.3 ASTM C-16.30/MIMA Round Roubins. Data from Lab 17 over the Time Period from 1974 to 1983 for Round Robin II (610-254 mm plates)

RR NO.	LAB NO.	DATE M Y	EQUIP TYPE	TEST COND.	SPEC. NO.	THICK. in	DENS. lb/ft ³	HOT TEMP	COLD TEMP	MEAN TEMP	K "Btu"	FOOT-NOTES
II 17	17	1078	H2410	105	1	1.00	0.685	100.0	50.0	75.0	0.304	cm
II 17	17	0178	H2410	105	1	1.00	0.685	100.0	50.0	75.0	0.303	cm
II 17	17	0178	H2410	105	5	1.00	0.668	100.0	50.0	75.0	0.305	cm
II 17	17	0178	H2410	105	5	1.00	0.668	100.0	50.0	75.0	0.305	cm
II 17	17	0178	H2410	110	2	1.00	1.039	100.0	50.0	75.0	0.267	cm
II 17	17	0178	H2410	110	2	1.00	1.039	100.0	50.0	75.0	0.266	cm
II 17	17	0178	H2410	110	6	1.00	1.069	100.0	50.0	75.0	0.265	cm
II 17	17	0178	H2410	115	3	1.00	1.604	100.0	50.0	75.0	0.243	cm
II 17	17	0178	H2410	115	3	1.00	1.604	100.0	50.0	75.0	0.242	cm
II 17	17	0178	H2410	115	7	1.00	1.592	100.0	50.0	75.0	0.242	cm
II 17	17	0178	H2410	115	7	1.00	1.592	100.0	50.0	75.0	0.242	cm
II 17	17	0178	H2410	120	4	1.00	2.054	100.0	50.0	75.0	0.233	cm
II 17	17	0178	H2410	120	4	1.00	2.054	100.0	50.0	75.0	0.233	cm
II 17	17	0178	H2410	120	8	1.00	2.029	100.0	50.0	75.0	0.232	cm
II 17	17	0178	H2410	120	8	1.00	2.029	100.0	50.0	75.0	0.232	cm
II 17	17	0378	H2410	105	1	1.00	0.685	100.0	50.0	75.0	0.307	cu
II 17	17	0378	H2410	105	5	1.00	0.668	100.0	50.0	75.0	0.308	cu
II 17	17	0378	H2410	110	2	1.00	1.039	100.0	50.0	75.0	0.269	cu
II 17	17	0378	H2410	110	6	1.00	1.069	100.0	50.0	75.0	0.267	cu
II 17	17	0378	H2410	115	3	1.00	1.604	100.0	50.0	75.0	0.245	cu
II 17	17	0378	H2410	115	7	1.00	1.592	100.0	50.0	75.0	0.244	cu
II 17	17	0378	H2410	120	4	1.00	2.054	100.0	50.0	75.0	0.235	cu
II 17	17	0378	H2410	120	8	1.00	2.029	100.0	50.0	75.0	0.234	cu

cm: Heat meter constant and thickness calibration supplied by equipment manufacturer.

cu: Heat meter constant and thickness calibration established by user.

"Btu" = Btu·in/h·ft²·°F

Table 13.7.4 ASTM C-16.30/MIMA Round Robins. Data from Lab I7 over the Time Period from 1974 to 1983 for Round Robin II (305-152 mm plates).

RR NO.	LAB NO.	DATE M Y	EQUIP TYPE	TEST COND.	SPEC. NO.	THICK. in	DENS. lb/ft ³	HOT TEMP	COLD TEMP	MEAN TEMP	k "Btu"	FOOT-NOTES
II 17	17	0674	H1206	105	1	1.00	0.661	100.0	50.0	75.0	0.312	b
II 17	17	0674	H1206	105	1	1.00	0.661	100.0	50.0	75.0	0.311	b
II 17	17	0674	H1206	105	5	1.00	0.672	100.0	50.0	75.0	0.310	b
II 17	17	0674	H1206	105	5	1.00	0.672	100.0	50.0	75.0	0.310	b
II 17	17	0674	H1206	110	2	1.00	1.098	100.0	50.0	75.0	0.266	b
II 17	17	0674	H1206	110	2	1.00	1.098	100.0	50.0	75.0	0.266	b
II 17	17	0674	H1206	110	6	1.00	1.114	100.0	50.0	75.0	0.267	b
II 17	17	0674	H1206	110	6	1.00	1.114	100.0	50.0	75.0	0.268	b
II 17	17	0674	H1206	115	3	1.00	1.617	100.0	50.0	75.0	0.246	b
II 17	17	0674	H1206	115	3	1.00	1.617	100.0	50.0	75.0	0.246	b
II 17	17	0674	H1206	115	7	1.00	1.617	100.0	50.0	75.0	0.246	b
II 17	17	0674	H1206	115	7	1.00	1.534	100.0	50.0	75.0	0.246	b
II 17	17	0674	H1206	115	7	1.00	1.534	100.0	50.0	75.0	0.246	b
II 17	17	0674	H1206	120	4	1.00	2.030	100.0	50.0	75.0	0.237	b
II 17	17	0674	H1206	120	4	1.00	2.030	100.0	50.0	75.0	0.237	b
II 17	17	0674	H1206	120	8	1.00	2.023	100.0	50.0	75.0	0.237	b
II 17	17	0674	H1206	120	8	1.00	2.023	100.0	50.0	75.0	0.236	b
II 17	17	0579	H1206	105	1	1.00	0.661	100.0	50.0	75.0	0.312	
II 17	17	0579	H1206	105	5	1.00	0.672	100.0	50.0	75.0	0.313	
II 17	17	0579	H1206	110	2	1.00	1.098	100.0	50.0	75.0	0.269	
II 17	17	0579	H1206	110	6	1.00	1.114	100.0	50.0	75.0	0.268	
II 17	17	0579	H1206	115	3	1.00	1.617	100.0	50.0	75.0	0.246	
II 17	17	0579	H1206	115	7	1.00	1.617	100.0	50.0	75.0	0.248	
II 17	17	0579	H1206	120	4	1.00	2.030	100.0	50.0	75.0	0.238	
II 17	17	0579	H1206	120	8	1.00	2.023	100.0	50.0	75.0	0.237	
II 17	17	0781	H1206	105	1	1.00	0.661	100.0	50.0	75.0	0.310	cd
II 17	17	0781	H1206	105	5	1.00	0.672	100.0	50.0	75.0	0.321	
II 17	17	0781	H1206	110	2	1.00	1.098	100.0	50.0	75.0	0.266	
II 17	17	0781	H1206	110	6	1.00	1.114	100.0	50.0	75.0	0.266	
II 17	17	0781	H1206	115	3	1.00	1.617	100.0	50.0	75.0	0.246	
II 17	17	0781	H1206	115	7	1.00	1.617	100.0	50.0	75.0	0.246	
II 17	17	0781	H1206	120	4	1.00	2.030	100.0	50.0	75.0	0.237	
II 17	17	0781	H1206	120	8	1.00	2.023	100.0	50.0	75.0	0.237	
II 17	17	1183	H1206	105	1	1.00	0.661	99.6	50.2	74.9	0.311	cd
II 17	17	1183	H1206	105	5	1.00	0.672	99.5	50.2	74.8	0.323	
II 17	17	1183	H1206	105	5	1.00	0.672	99.6	50.3	75.0	0.323	cd
II 17	17	1183	H1206	110	2	1.00	1.098	99.7	50.1	74.9	0.268	
II 17	17	1183	H1206	110	6	1.00	1.114	99.8	50.2	75.0	0.267	
II 17	17	1183	H1206	115	3	1.00	1.617	99.9	50.1	75.0	0.246	
II 17	17	1183	H1206	115	7	1.00	1.617	99.9	50.1	75.0	0.247	
II 17	17	1183	H1206	120	4	1.00	2.030	100.0	50.2	75.1	0.239	
II 17	17	1183	H1206	120	8	1.00	2.023	100.0	50.2	75.1	0.237	

"Btu" = Btu·in/h·ft²·°F

b: Reference values for the specimens based on NBS data.
cd: Specimen center test area damaged.

Table 13.7.5 ASTM C-16.30/MIMA Round Robins. Special Tests with Thickness and Temperature as Variables (with and without septum).

RR NO.	LAB NO.	DATE M Y	EQUIP TYPE	TEST COND.	SPEC. NO.	THICK. in	DENS. lb/ft ³	HOT TEMP	COLD TEMP	MEAN TEMP	k "Btu"	FOOT-NOTES
II 11	11	1178	H1204	305	15	2.00	0.675	95.2	55.3	75.3	0.313	e
II 11	11	1178	H1204	405	15	2.00	0.675	95.2	54.8	75.0	0.313	f
II 11	11	1178	H1204	310	26	2.00	1.108	95.1	55.3	75.2	0.267	e
II 11	11	1178	H1204	410	26	2.00	1.108	95.2	54.8	75.0	0.264	f
II 11	11	1178	H1204	315	37	2.00	1.655	95.1	55.2	75.2	0.248	e
II 11	11	1178	H1204	415	37	2.00	1.655	95.3	55.3	75.3	0.247	f
II 11	11	1178	H1204	320	48	2.00	2.078	94.7	55.1	74.9	0.237	e
II 11	11	1178	H1204	420	48	2.00	2.078	95.1	55.0	75.1	0.236	f
II 14	14	0478	H2410	305	15	2.00	0.676	98.8	50.5	74.7	0.319	e
II 14	14	0478	H2410	310	26	2.00	1.054	99.3	50.3	74.8	0.276	e
II 14	14	0478	H2410	315	37	2.00	1.598	99.5	50.4	75.0	0.251	e
II 14	14	0478	H2410	320	48	2.00	2.042	99.6	50.3	75.0	0.240	e
II 17	17	0378	H2410	305	15	2.02	0.676	100.0	50.0	75.0	0.316	e cu
II 17	17	0378	H2410	305	15	2.02	0.676	100.0	50.0	75.0	0.315	e cu
II 17	17	0378	H2410	310	26	2.02	1.054	100.0	50.0	75.0	0.274	e cu
II 17	17	0378	H2410	315	37	2.02	1.598	100.0	50.0	75.0	0.247	e cu
II 17	17	0378	H2410	320	48	2.02	2.042	100.0	50.0	75.0	0.249	e cu
II 17	17	0378	H2410	320	48	2.02	2.042	100.0	50.0	75.0	0.238	e cu
II 18	18	0377	H2410	305	15	2.00	0.676	96.4	50.3	73.4	0.316	e
II 18	18	0377	H2410	310	26	2.00	1.054	96.8	50.2	73.5	0.273	e
II 18	18	0377	H2410	315	37	2.00	1.598	100.2	50.3	75.3	0.248	e
II 18	18	0377	H2410	320	48	2.00	2.042	100.6	50.3	75.5	0.236	e
II 18	18	0377	H1204	105	1	1.00	0.679	39.2	3.5	21.4	0.261	t-r
II 18	18	0377	H1204	105	1	1.00	0.679	89.7	55.3	72.5	0.310	t-r
II 18	18	0377	H1204	110	2	1.00	1.138	40.8	5.1	23.0	0.388	t-r
II 18	18	0377	H1204	110	2	1.00	1.138	90.0	55.8	72.9	0.267	t-r
II 18	18	0377	H1204	115	7	1.00	1.138	156.3	120.3	138.3	0.324	t-r
II 18	18	0377	H1204	115	7	1.00	1.624	41.0	4.6	22.8	0.211	t-r
II 18	18	0377	H1204	115	7	1.00	1.624	90.1	55.1	72.6	0.243	t-r
II 18	18	0377	H1204	115	7	1.00	1.624	156.5	118.9	137.7	0.284	t-r
II 18	18	0377	H1204	120	8	1.00	2.067	40.9	5.3	23.1	0.208	t-r
II 18	18	0377	H1204	120	8	1.00	2.067	90.1	54.9	72.5	0.238	t-r
II 18	18	0377	H1204	120	8	1.00	2.067	156.5	119.9	138.2	0.277	t-r

"Btu" = Btu·in/h·ft²·°F

e: Two specimens stacked to 5.08 cm, tested without septum.

f: Two specimens stacked to 5.08 cm, tested with septum.

t-r: Specimens tested over a broader temperature range.

cu: Heat meter constant established by user.

Table 13.8.1 ASTM C-16.30/MIMA Round Robins. Primary Data for Round Robin III.*

RR NO.	LAB NO.	DATE M Y	EQUIP TYPE	TEST COND.	SPEC. NO.	THICK. in	DENS. lb/ft ³	HOT TEMP	COLD TEMP	MEAN TEMP	k "Btu"	FOOT-NOTES
III	12	0180	G4818	507	1	1.00	0.723	95.0	55.3	75.2	0.304	
III	12	0180	G4818	607	12	2.00	0.714	95.0	55.2	75.1	0.308	
III	12	0180	G4818	707	123	3.00	0.714	95.0	55.2	75.1	0.310	
III	12	0180	G4818	807	1234	4.00	0.711	95.0	55.2	75.1	0.311	
III	12	0180	G4818	509	1	1.00	0.979	95.1	55.2	75.2	0.275	
III	12	0180	G4818	609	12	2.00	0.981	95.1	55.2	75.2	0.279	
III	12	0180	G4818	709	123	3.00	0.980	95.2	55.1	75.2	0.280	
III	12	0180	G4818	809	1234	4.00	0.976	95.1	55.1	75.1	0.282	
III	12	0180	G4818	512	1	1.00	1.211	95.0	55.2	75.1	0.261	
III	12	0180	G4818	612	12	2.00	1.192	95.1	55.2	75.2	0.264	
III	12	0180	G4818	712	123	3.00	1.207	95.0	55.2	75.1	0.265	
III	12	0180	G4818	812	1234	4.00	1.202	95.1	55.3	75.2	0.267	
III	15	1080	G2412	507	1	1.00	0.740	100.0	50.2	75.1	0.299	
III	15	1080	G2412	607	12	2.00	0.716	99.7	49.7	74.7	0.303	
III	15	1080	G2412	707	123	3.00	0.718	100.8	49.9	75.4	0.305	
III	15	1080	G2412	807	1234	4.00	0.711	100.6	50.0	75.3	0.308	
III	15	1080	G2412	509	1	1.00	0.955	99.7	50.1	74.9	0.273	
III	15	1080	G2412	609	12	1.99	0.967	100.0	49.8	74.9	0.275	
III	15	1080	G2412	709	123	3.00	0.974	99.9	49.7	74.8	0.277	
III	15	1080	G2412	809	1234	4.00	0.968	99.2	49.6	74.4	0.278	
III	15	1180	G2412	512	1	1.00	1.199	100.2	50.1	75.2	0.260	
III	15	1180	G2412	612	12	1.99	1.179	99.3	49.8	74.6	0.261	
III	15	1180	G2412	712	123	2.99	1.206	100.0	49.7	74.9	0.262	
III	15	1180	G2412	812	1234	4.00	1.203	99.2	49.6	74.4	0.264	
III	18	0483	G2412	507	1	1.00	0.740	97.8	48.8	73.3	0.301	ed
III	18	0483	G2412	607	12	2.00	0.716	100.2	51.2	75.7	0.312	ed
III	18	0483	G2412	707	123	3.00	0.718	100.5	50.9	75.7	0.309	ed
III	18	0483	G2412	807	1234	4.00	0.711	100.5	50.6	75.6	0.309	ed
III	18	0483	G2412	509	1	1.00	0.955	100.5	52.3	76.4	0.272	ed
III	18	0483	G2412	609	12	2.00	0.967	98.4	49.9	74.2	0.278	ed
III	18	0483	G2412	709	123	3.00	0.974	100.5	49.8	75.2	0.276	ed
III	18	0483	G2412	809	1234	4.00	0.968	99.1	50.0	74.6	0.277	ed
III	18	0483	G2412	512	1	1.00	1.199	100.5	51.7	76.1	0.260	ed
III	18	0483	G2412	612	12	2.00	1.179	99.6	50.9	75.3	0.265	ed
III	18	0483	G2412	712	123	3.00	1.206	99.9	50.6	75.3	0.264	ed
III	18	0483	G2412	812	1234	4.00	1.203	100.2	50.4	75.3	0.263	ed
III	22	1182	G3616	507	1	1.00	0.733	92.4	57.2	74.8	0.300	cpu
III	22	1182	G3616	607	12	2.00	0.718	100.0	50.8	75.4	0.300	cpu
III	22	1182	G3616	707	123	3.00	0.718	99.8	51.41	75.6	0.316	cpu
III	22	1182	G3616	807	1234	4.00	0.713	98.7	51.3	75.0	0.306	cpu
III	22	0481	G3616	509	1	1.00	0.980	88.9	56.5	72.7	0.276	cpu
III	22	0481	G3616	609	12	2.00	0.985	95.3	52.9	74.1	0.281	cpu
III	22	0481	G3616	709	123	3.00	0.984	95.2	52.9	74.1	0.283	cpu
III	22	0481	G3616	809	1234	4.00	0.979	98.8	56.1	77.5	0.283	cpu
III	22	0481	G3616	512	1	1.00	1.212	92.6	56.7	74.7	0.265	cpu
III	22	0481	G3616	612	12	2.00	1.193	97.1	53.0	75.1	0.269	cpu
III	22	0481	G3616	712	123	3.00	1.213	98.5	52.8	75.7	0.271	cpu
III	22	0481	G3616	812	1234	4.00	1.210	97.0	53.0	75.0	0.277	cpu

"Btu" = Btu·in/h·ft²·°F

*Lab 13 data given in Table 13.5.2

cpu: Tests performed with insulated cold plates

cpu: Tests performed with uninsulated cold plates

ed: Equipment difficulty reported

Table 13.8.2 ASTM C-16.30/MIMA Round Robins. Secondary Data for Round Robin III.

RR NO.	LAB NO.	DATE M Y	EQUIP TYPE	TEST COND.	SPEC. NO.	THICK. in	DENS. lb/ft ³	HOT TEMP.	COLD TEMP.	MEAN TEMP.	k "Btu"	FOOT-NOTES
III	12	0180	G4818	507	2	1.00	0.705	95.0	55.0	75.0	0.303	i
III	12	0180	G4818	507	3	1.00	0.712	95.0	55.0	75.0	0.298	i
III	12	0180	G4818	507	4	1.00	0.702	95.0	55.0	75.0	0.302	i
III	12	0180	G4818	509	2	1.00	0.983	95.0	55.0	75.0	0.276	i
III	12	0180	G4818	509	3	1.00	0.980	95.0	55.0	75.0	0.274	i
III	12	0180	G4818	509	4	1.00	0.964	95.0	55.0	75.0	0.278	i
III	12	0180	G4818	512	2	1.00	1.173	95.0	55.0	75.0	0.263	i
III	12	0180	G4818	512	3	1.00	1.238	95.0	55.0	75.0	0.259	i
III	12	0180	G4818	512	4	1.00	1.184	95.0	55.0	75.0	0.263	i

i: Temperature not given. Data assumed on basis of others.

"Btu" = Btu-in/h-ft²-°F

Table 13.8.3 ASTM C16.30/MIMA Round Robins. Tests Performed at lab 17 on Individual Stacked Sets of Specimens from Round Robin III using Heat Meter Apparatus.

RR NO.	LAB NO.	DATE M Y	EQUIP TYPE	TEST COND.	SPEC. NO.	THICK. in	DENS. lb/ft ³	HOT TEMP	COLD TEMP	MEAN TEMP	k "Btu"	FOOT-NOTES
III 17	17	1083	H3612	109	1	1.00	0.978	100.0	50.0	75.0	0.275	
III 17	17	1083	H3612	109	5	1.00	0.972	100.0	50.0	75.0	0.272	
III 17	17	1083	H3612	509	1	1.00	0.975	100.0	50.0	75.0	0.274	cal
III 17	17	1083	H3612	309	12	2.00	0.976	100.0	50.0	75.0	0.277	
III 17	17	1083	H3612	309	56	2.00	0.968	100.0	50.0	75.0	0.275	
III 17	17	1083	H3612	609	12	2.00	0.972	100.0	50.0	75.0	0.276	cal
III 17	17	1083	H3612	309	123	3.00	0.974	100.0	50.0	75.0	0.276	
III 17	17	1083	H3612	309	567	3.00	0.974	100.0	50.0	75.0	0.275	
III 17	17	1083	H3612	709	123	3.00	0.974	100.0	50.0	75.0	0.275	cal
III 17	17	1083	H3612	309	1234	4.00	0.973	100.0	50.0	75.0	0.277	
III 17	17	1083	H3612	309	5678	4.00	0.964	100.0	50.0	75.0	0.278	
III 17	17	1083	H3612	809	1234	4.00	0.968	100.0	50.0	75.0	0.278	cal
III 17	17	1083	H3612	112	1	1.00	1.195	100.0	50.0	75.0	0.260	
III 17	17	1083	H3612	112	5	1.00	1.202	100.0	50.0	75.0	0.260	
III 17	17	1083	H3612	512	1	1.00	1.199	100.0	50.0	75.0	0.260	cal
III 17	17	1083	H3612	312	12	2.00	1.164	100.0	50.0	75.0	0.264	
III 17	17	1083	H3612	312	56	2.00	1.194	100.0	50.0	75.0	0.263	cal
III 17	17	1083	H3612	612	12	2.00	1.179	100.0	50.0	75.0	0.263	
III 17	17	1083	H3612	312	123	3.00	1.218	100.0	50.0	75.0	0.260	
III 17	17	1083	H3612	712	567	3.00	1.203	100.0	50.0	75.0	0.262	cal
III 17	17	1083	H3612	312	1234	4.00	1.209	100.0	50.0	75.0	0.262	
III 17	17	1083	H3612	312	5678	4.00	1.204	100.0	50.0	75.0	0.264	
III 17	17	1083	H3612	812	1234	4.00	1.203	100.0	50.0	75.0	0.263	cal
III 17	17	1083	H3612	107	1	1.00	0.740	100.0	50.0	75.0	0.294	
III 17	17	1083	H3612	107	5	1.00	0.739	100.0	50.0	75.0	0.302	
III 17	17	1083	H3612	507	1	1.00	0.740	100.0	50.0	75.0	0.298	cal
III 17	17	1083	H3612	307	12	2.00	0.730	100.0	50.0	75.0	0.301	
III 17	17	1083	H3612	607	56	2.00	0.702	100.0	50.0	75.0	0.304	
III 17	17	1083	H3612	607	12	2.00	0.716	100.0	50.0	75.0	0.303	cal
III 17	17	1083	H3612	307	123	3.00	0.734	100.0	50.0	75.0	0.304	
III 17	17	1083	H3612	307	567	3.00	0.702	100.0	50.0	75.0	0.303	
III 17	17	1083	H3612	707	123	3.00	0.718	100.0	50.0	75.0	0.304	cal
III 17	17	1083	H3612	307	1234	4.00	0.728	100.0	50.0	75.0	0.304	
III 17	17	1083	H3612	307	5678	4.00	0.693	100.0	50.0	75.0	0.305	
III 17	17	1083	H3612	807	1234	4.00	0.713	100.0	50.0	75.0	0.305	cal

cal: Average values calculated for the previous pair of specimens.
 "Btu" = Btu·in/h·ft²·°F

U.S. DEPT. OF COMM. BIBLIOGRAPHIC DATA SHEET <i>(See instructions)</i>	1. PUBLICATION OR REPORT NO. NBSIR 85-3026	2. Performing Organ. Report No.	3. Publication Date May 1985
4. TITLE AND SUBTITLE Round Robins on the Apparent Thermal Conductivity of Low-Density Glass Fiber Insulations Using Guarded Hot Plate and Heat Flow Meter Apparatus			
5. AUTHOR(S) J. G. Hust and C. M. Pelanne			
6. PERFORMING ORGANIZATION <i>(If joint or other than NBS, see instructions)</i> NATIONAL BUREAU OF STANDARDS DEPARTMENT OF COMMERCE WASHINGTON, D.C. 20234		7. Contract/Grant No. 8. Type of Report & Period Covered	
9. SPONSORING ORGANIZATION NAME AND COMPLETE ADDRESS <i>(Street, City, State, ZIP)</i> U.S. Department of Energy Oak Ridge National Laboratory P.O. Box X Oak Ridge, TN 37830			
10. SUPPLEMENTARY NOTES <input type="checkbox"/> Document describes a computer program; SF-185, FIPS Software Summary, is attached.			
11. ABSTRACT <i>(A 200-word or less factual summary of most significant information. If document includes a significant bibliography or literature survey, mention it here)</i> <p>This National Bureau of Standards report presents the results and the data analysis pertaining to these results for three round robins on the thermal performance of guarded hot plates and heat flow meters when measuring the thermal resistance properties of low density glass fibrous thermal insulations. The three round robins were carried out under the sponsorship of the American Society for Testing and Materials (ASTM) Subcommittee C-16.30 on Thermal Measurements and the Mineral Insulation Manufacturers Association (MIMA).</p> <p>The test results are compared to a reference equation and to each other to illustrate intralaboratory and interlaboratory reproducibility as well as the dependencies on temperature, density, plate emittance, specimen thickness, and fiber diameter.</p> <p>The study shows that, with good laboratory practices, interlaboratory agreement of about 2% is obtained. Over 300 test results obtained by 12 different laboratories are reported. This report also discusses the magnitude of the specimen thickness effect and its dependence on plate emittance.</p>			
12. KEY WORDS <i>(Six to twelve entries; alphabetical order; capitalize only proper names; and separate key words by semicolons)</i> apparent thermal conductivity; guarded hot plate; heat flow meter; low density; Round Robins; thermal insulation; thickness effect			
13. AVAILABILITY <input checked="" type="checkbox"/> Unlimited <input type="checkbox"/> For Official Distribution. Do Not Release to NTIS <input type="checkbox"/> Order From Superintendent of Documents, U.S. Government Printing Office, Washington, D.C. 20402. <input checked="" type="checkbox"/> Order From National Technical Information Service (NTIS), Springfield, VA. 22161		14. NO. OF PRINTED PAGES 134 15. Price	

