

1279 213.04
100 copies

NBSIR 75-685

Improved Ultrasonic Standard Reference Blocks

D. G. Eitzen, G. F. Sushinsky, and D. J. Chwirut

Engineering Mechanics Section
Mechanics Division
Institute for Basic Standards

and

C. J. Bechtoldt and A. W. Ruff

Microstructure Characterization Section
Metallurgy Division
Institute for Materials Research

National Bureau of Standards
Washington, D.C. 20234

April 1975

Interim Report for Period January 1, 1974 to December 31, 1974

Prepared for

**Air Force Materials Laboratory
National Aeronautics and Space Administration and
Army Materials and Mechanics Research Center**

NBSIR 75-685

IMPROVED ULTRASONIC STANDARD REFERENCE BLOCKS

D. G. Eitzen, G. F. Sushinsky, and D. J. Chwirut

Engineering Mechanics Section
Mechanics Division
Institute for Basic Standards

and

C. J. Bechtoldt and A. W. Ruff

Microstructure Characterization Section
Metallurgy Division
Institute for Materials Research

National Bureau of Standards
Washington, D.C. 20234

April 1975

Interim Report for Period January 1, 1974 to December 31, 1974

Prepared for

Air Force Materials Laboratory,
National Aeronautics and Space Administration, and
Army Materials and Mechanics Research Center



U. S. DEPARTMENT OF COMMERCE, Rogers C. B. Morton, Secretary

NATIONAL BUREAU OF STANDARDS, Richard W. Roberts, Director

CONTENTS

	Page
1. INTRODUCTION	1
2. PROGRAM OUTLINE	3
3. ACTIVITY SUMMARY	5
3.1 Literature Survey	5
3.2 Ultrasonic Measurement Facility	6
3.2.1 Immersion System	7
3.2.2 Flaw Detection Equipment	7
3.2.3 Spectrum Analyzer	7
3.2.4 Accessory Equipment	8
3.3 Comparison of Nominally Identical Blocks	8
3.4 Metallurgical Considerations	10
3.4.1 Orientation Texture	10
3.4.2 Reference Block Microstructure	12
3.4.3 Ultrasonic Inspection of Rejected Block	13
3.5 Fabrication Considerations	14
3.6 Effects of Ultrasonic Measuring Systems	15
3.7 Single Material Standard	16
3.8 ASTM Participation	16
4. IMPORTANT CONCLUSIONS TO DATE	16
5. ACKNOWLEDGEMENTS	17
6. REFERENCES	18
Appendix A	A-1
Appendix B	B-1
Appendix C	C-1
Appendix D	D-1
Appendix E	E-1

IMPROVED ULTRASONIC STANDARD REFERENCE BLOCKS

D. G. Eitzen, G. F. Sushinsky, and D. J. Chwirut

ABSTRACT

A program to improve the quality, reproducibility and reliability of nondestructive testing through the development of improved ASTM-type ultrasonic reference standards is described. Reference blocks of aluminum, steel, and titanium alloys are to be considered. Equipment representing the state-of-the-art in laboratory and field ultrasonic equipment was obtained and evaluated. RF and spectral data on ten sets of ultrasonic reference blocks have been taken as part of a task to quantify the variability in response from nominally identical blocks. Techniques for residual stress, preferred orientation, and microstructural measurements were refined and are applied to a reference block rejected by the manufacturer during fabrication in order to evaluate the effect of metallurgical condition on block response. New fabrication techniques for reference blocks are discussed and ASTM activities are summarized.

Key Words: Aluminum ultrasonic standards; ASTM-type reference blocks; fabrication of reference blocks; immersion testing; longitudinal waves; metallurgical variables; nondestructive testing; pulse-echo; steel ultrasonic standards; titanium ultrasonic standards; ultrasonics.

1. INTRODUCTION

In a wide range of technical activities, a greater dependence on nondestructive testing and evaluation (NDT and E) methods is being witnessed. The causes for this greater dependence on NDT and E methods include increased structural performance requirements, the use of defect-sensitive materials, changes in design philosophy, and increased requirements for the determination of the condition and changes in the condition of materials in service. The world-wide shortages of materials and energy have created pressure for the adoption of a "keep it in service if possible" attitude to replace the old "remove and replace on schedule" philosophy.

In particular, ultrasonic methods are being increasingly relied upon to evaluate material and structural condition. Characteristically, the NDT and E activities are performed at interfaces between different operational groups, e.g., material supplier - user, subcontractor - contractor, and part production - assembly. Lack of agreement in the

results of ultrasonic evaluations at such interfaces can, in part, be traced to a lack of standard methodology and a lack of basic measurement standards since the techniques are highly dependent on reference standards. The incompatibility of measurements by different operational groups results in uncertainties regarding the actual material condition. These uncertainties lead to performance penalties due to increased design uncertainties and either unnecessary piece rejection or inadequate service performance. In addition to the performance penalties, serious economic inequities often result from the lack of reference standards or measurement inaccuracies.

A program to improve the widely used system of ASTM-type reference blocks for longitudinal ultrasonic testing was started in January 1974. The procedures for fabricating and checking these blocks are covered in two ASTM documents, E 127-64 "Standard Recommended Practice for Fabricating and Checking Aluminum Alloy Ultrasonic Standard Reference Blocks" [1]*, and E 428-71, "Standard Recommended Practice for Fabrication and Control of Steel Reference Blocks Used in Ultrasonic Inspection" [2]. Both of these documents are widely referenced in government and industry purchasing specifications and many other ASTM documents. One of the above documents is also sometimes used as a guide for the fabrication of titanium alloy ultrasonic reference blocks. However, both the authors and users of these documents admit that both contain serious shortcomings, but, partly because of corporate interests or priorities and a lack of institutional mission, no one has produced acceptable improvements through the voluntary standards systems. In fact, E 127 is scheduled to be dropped in January 1976 because it is unworkable in its present form yet no acceptable alternative has been produced to date. A stop-gap alternative may be approved later this year, but it is far from a total solution to the problem.

The ASTM-type reference blocks are cylindrical blocks with flat-bottomed holes drilled along the block axis, see Figure 1. A pulsed stress wave produced by a piezoelectric transducer enters normal to the undrilled end of the block and travels through the block. The flat end of the drilled hole acts as a reflector and returns some of the energy to the transducer which converts this energy into an electrical signal. This reflected signal, displayed on a cathode ray tube (CRT), becomes a reference signal for the evaluation of material of unknown condition. Sets of reference blocks with different hole diameters and different lengths are used to standardize ultrasonic measurement systems. Measurements made with these systems then provide a basis for estimating flaw severity and possible material rejection.

The problem with the reference blocks, simply stated, is this: using a single ultrasonic measuring system, the ultrasonic response

*Figures in brackets indicate literature references at the end of this paper.

from nominally identical reference blocks varies unacceptably. The extent of this variation has been reported to be as great as 300 percent in titanium. This causes, for example, different materials suppliers and users to inspect to different levels of acceptability, resulting in unjust competition between suppliers and increased costs due to unnecessary rejection and recycling (supplier over inspection) or wasted transportation costs following user rejection (supplier under inspection). The NBS program is intended to investigate systematically the ASTM-type standard reference block system, to isolate if possible the causes of the variability, and to develop a new system of standards that will allow different organizations to make consistent measurements compatible with each other. It is envisioned that the output from this program could take one of three forms:

- 1) New methods documents to revise or replace ASTM E 127 and E 428 that would allow the NDT community to fabricate standard reference blocks that introduce acceptably small variability into the measurement system,
- 2) a system whereby certified standard reference blocks would be fabricated, and sold by the National Bureau of Standards through, for example, the Standard Reference Materials Program,
- 3) a calibration service whereby one set of blocks is defined as THE STANDARD SET. Users' blocks could then be referenced to this set following prescribed procedures.

This program is centered in the Mechanics and Metallurgy Divisions of the National Bureau of Standards with consultation and support from other Divisions where appropriate.

2. PROGRAM OUTLINE

The objective of the program is to affect near-term improvements in the quality, reproducibility and reliability of ultrasonic nondestructive testing through the development of improved ASTM-type reference blocks. The materials to be used for the development of standards include aluminum, titanium and steel. The program is a two year effort to include the following nine tasks:

Task 1. Literature Search - A thorough search and review of all technical literature regarding ultrasonic test standards will be conducted prior to commencement of any major subsequent tasks. Results of the review will be used where applicable to accelerate or modify subsequent tasks.

Task 2. Ultrasonic Measurement Facility - State-of-the-art ultrasonic equipment and associated electronics appropriate for pulse-echo contact and immersion evaluations will be obtained. This equipment will be evaluated using current standardization methodology. This evaluation will be performed with a view towards the establishment of standard

methods which are more definitive than those currently available. This equipment is intended to form the core of an ultrasonic reference block calibration facility, if established.

Task 3. Comparison of Nominally Identical Blocks - Nominally identical blocks from commercial sources and from the field will be evaluated for the distribution of ultrasonic response using the equipment of task 2. This task will serve to assess the extent of variability of ultrasonic responses from nominally identical blocks. The results of this evaluation will have an effect on the methods used to identify the causes of the deviations in blocks.

Task 4. Metallurgical Considerations - The current state of knowledge of the effects of the metallurgical conditions of materials on their ultrasonic characteristics will be reviewed. A limited number of confirmation experiments will be performed. Additional tests on materials of other metallurgical consistency will be undertaken to determine their ultrasonic response characteristics. This knowledge will be applied to the selection of materials for the fabrication of a master set of ASTM-type ultrasonic reference blocks.

Task 5. Fabrication Considerations - A number of nominally identical reference blocks with closely controlled metallurgical properties and fabrication techniques will be obtained. The blocks will be closely examined metrologically and the distribution of ultrasonic response will be determined using the measurements laboratory of Task 2. Several forming techniques will be used including the conventional drilling technique, the use of raw stock formed by powder metallurgy, and the use of two-piece blocks. Comparison of the distributions in response of these blocks with the results of the evaluation of nominally identical field blocks (Task 3) will indicate whether significant reductions in the deviation of ultrasonic response of blocks can be anticipated in the near-term.

Task 6. Effects of Ultrasonic Measuring Systems - The results of previous round-robins on ASTM-type reference blocks will be checked to determine whether different ultrasonic measuring systems obtain the same ranking and distribution of ultrasonic response from nominally identical blocks. An additional round-robin will be performed, if necessary. The cooperation of interested NDT users will be sought. The verification of the principle of standardization associated with this task is a necessary step toward the establishment of a rational calibration program.

Task 7. Master Reference Blocks - The results of the above tasks will be used to develop master ASTM-type reference standards for aluminum, steel, and titanium. The final alloy selections for the master standards will be based on metallurgical considerations, long-term availability, ultrasonic response, incidence of structural use, and in consultation with the sponsors.

Task 8. A Single-Material Standard - An effort will be made to establish the feasibility of an improved standards program through the use of a single-material master standard. A candidate for the single-material standard is considered to be blocks made of crown glass. This material can be controlled to have an impedance matching that of aluminum, has no crystalline structure, has a minimal defect count (which can be evaluated by light-scattering techniques), and is amenable to the most sophisticated metrological evaluation. Preliminary analyses and tests will establish the feasibility of a one-material standard as the basis for determining the ultrasonic response of reference blocks of various materials. Based on appropriate feasibility indications the development of a basic standard will be considered. Future work may then be proposed in order to establish this standard.

Task 9. Calibration Service - An ASTM-type reference block calibration service will be initiated if appropriate. A system will be established to quantify the responses of blocks in terms of the NBS master standards, thus providing a common basis for comparison and an objective evaluation. Blocks will be evaluated in terms of the Master Reference Blocks of Task 7. It is expected that any continuing calibration service will be self-supporting through fees collected from the users.

The estimated program timetable is as shown in Figure 2.

3. ACTIVITY SUMMARY

3.1 Literature Survey

An extensive search and review of the open literature regarding ultrasonic reference standards has resulted in a collection of over two hundred documents. The search has included four areas: General background information, ultrasonic measurement techniques, previous work directly on standards, and the relationship of metallurgical variables to ultrasonic response. Formal inputs to the search were received from:

Nondestructive Testing Information and Analysis Center,
Defense Documentation Center,
National Technical Information Service, and
Smithsonian Science Information Exchange.

Of these the input from NTIAC was the most comprehensive. The number of pieces of open literature requiring review was surprisingly large, but few speak directly and conclusively to the problem.

In addition to the open literature, several dozen private documents or communications have been analyzed. The search for unpublished or private communications has been more time consuming but often more substantive. Important information regarding ultrasonic reference standards has been obtained through exchanges with representatives from such

organizations as Automation Industries, Krautkramer-Branson Inc., Reynolds Metals Company, Aluminum Company of America, Westinghouse Electric Corporation, Kaiser Aluminum Company, Air Force Materials Laboratory, Army Materials and Mechanics Research Center, Naval Research Labs, Titanium Metals Corporation, Boeing Airplane Company, Douglas Aircraft Co., General Dynamics, Grumman Aerospace Corp., The United Kingdom's Aeronautical Quality Assurance Directorate Labs and Atomic Energy Research Establishment Harwell Labs, and of course the American Society for Testing and Materials.

A conclusion as to what is the major cause(s) of the wide distribution of response from nominally identical blocks when examined with a given ultrasonic system was an important objective of the literature search. No conclusion could be drawn. There were significant but sometimes contradictory statements indicating material or metallurgical, dimensional and fabrication problems. Apparently this question will not be resolved until studies based on the results of Task 3 are completed. The review of previous and ongoing work did result in several, more positive conclusions. From work in the United Kingdom over the last ten years it is concluded that "calibrations" by a corrected comparison with a standard set of aluminum blocks can be made to within 1 dB, using state-of-the-art equipment, and that sufficient reductions in block disparity to the point where corrections are not required will be difficult [3]. From work at Grumman [4] on reference blocks for titanium it is concluded that two piece blocks may provide improved standards for this material. From communications concerning work at Westinghouse and Automation Industries, there is a large disagreement about the size of the problem with steel reference blocks. An additional, important conclusion is that the most active concentrated help can be expected from members of ASTM committee E-7.06. The aluminum producers have been particularly cooperative thus far.

3.2 Ultrasonic Measurement Facility

Commercially available, state-of-the-art ultrasonic equipment and accessories suitable for contact and immersion testing have been assembled through loans, through purchases with project funds and through the availability of NBS equipment for the project. This includes an immersion tank with a motorized scanning bridge and precision manipulator, flaw detection equipment with associated gating and amplifying circuitry, a spectrum analyzer, and other accessory equipment. The laboratory set-up is shown in Figure 3. Brief descriptions of this equipment are included below with more detailed specifications and characteristics given in Appendix A.

3.2.1 Immersion System

The immersion system consists of a tank with transparent walls and dimensions of approximately 38x21x18 in (97x53x46 cm)*. It is equipped with a motorized bridge and carriage, search tube, motorized manipulator, and mini-manipulator. It provides precision control of search unit positioning in the X,Y and Z directions, as well as angular positioning in two vertical planes normal to the tank bottom. A dry paper X-Y recorder is provided.

3.2.2 Flaw Detection Equipment

Two field inspection type flaw detection units, on loan from AFML and NRL are currently available for use in the laboratory. These units feature a tuned, narrow band pulser and receiver combination. Their nominal operating frequencies are 1.0, 2.25, 5.0, and 10.0 MHz. A video (as opposed to RF) presentation on the CRT is featured. Gating and amplifying modules have also been borrowed. A third unit with updated features is on order. In addition to the above features, this third unit has a "calibrated" dB sensitivity control, an improved CRT display and improved gating and amplifying circuitry. These units are suitable for checking ultrasonic reference blocks per ASTM "Standard Recommended Practice for Fabricating and Checking Aluminum Alloy Ultrasonic Standard Reference Blocks" [1].

A flaw detector suitable for collecting more detailed laboratory data was also acquired. This unit consists of a power supply-frame, and a broadband pulser receiver combination, stepless gate, and peak detection and quantizing modules. Ultrasonic RF signals are displayed on a 100 MHz bandwidth storage oscilloscope equipped with two wide-band amplifiers. The stepless gate, peak detector, and quantizer provide much of the necessary electronic signal processing for quantitative flaw and search unit characterization. Signals are routed from the receiver through the stepless gate where signals reflected from discontinuities other than the one of interest are eliminated from the repetitive pulse train and the desired wave packet is isolated. This signal can then be used for spectrum analysis or further processed by the peak detector and quantizer. The peak detector converts the positive peak amplitude of the signal to a proportional DC voltage. This can then be quantized into discrete DC voltages based on incremental signal amplitude changes. Such processing is suitable for beam profiling, attenuation measurements or gray-tone C-scan recordings.

3.2.3 Spectrum Analyzer

Spectrum analysis is performed on ultrasonic signals received by the transducer after being processed through the gate circuitry.

*Units for physical quantities in this paper are given in both the U. S. Customary Units and the International System Units (SI).

Signals analyzed are those reflected from special targets (e.g. steel balls, flat quartz blocks) or defects. This information is necessary for the evaluation of search unit characteristics and potentially helpful in determining defect size and orientation [5, 6]. In this program the information will be applied to the determination of the size and orientation of flat bottomed holes in reference blocks. The spectrum analyzer consists of a storage CRT display, and separate IF and RF plug-in modules. The frequency range extends from 0 to 110 MHz with both logarithmic and linear sensitivity displays. Signals processed through the stepless gate can be monitored for spectral content using this instrument.

3.2.4 Accessory Equipment

Search units for use in contact and immersion longitudinal pulse-echo testing made by three different manufacturers have been obtained. The units were chosen on the basis of crystal diameter and nominal center frequency to cover a representative range of those used in ultrasonic work. Special emphasis was placed on obtaining a few quartz search units suitable for work on standard artifacts in accordance with ASTM E 127 [1] and on units from which to choose for Task 3.

Seven sets of ultrasonic reference standards have been purchased from three different manufacturers. These consist of three "Distance/Area Amplitude" sets (basic sets), purchased directly from the Defense Supply Agency (the source of most Air Force field blocks) and four "Distance Amplitude" sets. The "Distance Amplitude" sets consist of 2 sets of "number 3"* blocks from the same manufacturer and one set each of "number 5 and 8" blocks from the third supplier. This sample will provide a measure of the inconsistency of products manufactured by different producers as well as the variability of the standards produced by the same manufacturer. These sets constitute part of the data base to be established at this laboratory. In addition they provide convenient working standards for activities in the program such as the evaluation of new fabrication techniques and consistency checks when different transducers are used.

3.3 Comparison of Nominally Identical Blocks

An important step toward decreasing the disparity in the ASTM-type ultrasonic reference blocks is a survey of nominally identical blocks. The purpose of the survey is to quantify the extent of variability in field blocks presently being used by the NDT community. Participation was enlisted from the membership of ASTM E-07.06, the ultrasonics subcommittee, and from the general NDT community through an appeal in

*These reference standards are commonly referred to as "number x" blocks where x represents the diameter of the "flat bottomed hole in 64 THS of an inch (1 in = 2.54 cm)."

the Nondestructive Testing Information and Analysis Center Newsletter. A list of organizations which have formally offered the loan of reference blocks for data gathering purposes is presented in Appendix B. Five borrowed sets of aluminum blocks have been inspected to date. Additional blocks, aluminum, titanium and steel, have been scheduled. In addition five sets of purchased blocks, 2 distance amplitude sets from one manufacturer and three basic sets from another manufacturer (through the Defense Supply Agency) have been evaluated. Pulse-echo ultrasonic response data were taken from the blocks at three test frequencies, 2.25, 5 and 10 MHz, using the immersion tank with temperature controlled distilled water, wide-band pulser/receiver, stepless gate, oscilloscope and spectrum analyzer previously described. The ultrasonic measurement system was used only in its linear range as determined from the response from steel balls. Some characteristics of the search units used for the data are given in Table 1. All search units on hand at the start of data taking were checked for symmetry, location of the Y_0^+ point (point of separation of near and far fields) [7], center frequency and frequency envelope, RF waveform and sensitivity. The search units used to gather the reference block data were selected on the basis of the above factors.

In taking the data on the blocks, all pulser/receiver settings were put at a repeatable position. The gain was set using the reflected signal from a selected steel ball positioned and maximized at the measured Y_0^+ point. The standardization points for the particular test conditions are given in Table 2. The standardization points served only as a basis for comparison of blocks with a given hole size and were chosen to give the response nearest to the block with a 0.50 in (13 mm) metal travel distance from the first set tested. After the pulser/receiver settings were selected, the transducer was positioned so that the Y_0^+ point was at the ultrasound entry surface of the block. Then the return signal from this surface was maximized by angulating the transducer. The oscilloscope time delay was used to expand the signal reflected from the hole bottom. This signal was tapped off to the stepless gate, which can be set so that the output from this module contains only the signal of interest. Thus, only the return signal from the flat-bottomed hole is fed into the spectrum analyzer. The data collected for each block includes photo-recordings of the RF waveform and the spectrum of the signal from the hole bottom, and a recording of the peak-to-peak voltage and all pertinent equipment settings. Since only one of the ten sets of blocks evaluated was an Area-Amplitude set, the peak-to-peak voltage data is plotted against metal travel distance for number 3, 5, and 8 hole sizes at each of the three frequencies, Figures 4-12. Figure 13 presents typical photo-recordings of the RF signal and the signal spectrum.

As can be seen from Figures 4-12, several anomalies were noted in this study. The unserial-numbered set of number 5 blocks (Figures 5, 8, 11) give very inconsistent response, and in fact the response increases with increasing metal distance at 5 and 10 MHz with differences between nominally identical blocks that are in excess of 700%. The blocks in set B-0109 appear to give consistently higher response than

blocks in other sets, with differences as high as 200% (Figure 12). It appears that several widely variant blocks will be available for inspection under tasks 4 and 5, in order to determine the actual causes of the variability. One might conjecture, however, that at least a part of the disparity is due to a material condition since one might expect more random variances from the mean to result from other suspected variables such as improper geometry.

3.4 Metallurgical Considerations

This task is concerned with the evaluation of the distribution in response of ultrasonic reference blocks and the material from which they are fabricated, particularly in connection with metallurgical and microstructural parameters. The emphasis has been on aluminum alloys so far, however, titanium has been examined briefly and will be studied further in the next year. Some emphasis will also be placed on steel. An aluminum reference block rejected by the manufacturer during fabrication is currently under close examination. Correlations are being sought between ultrasonic response anomalies and microstructural features. Techniques for residual stress measurements, preferred orientation measurements and microstructural measurements have been refined and are being applied in this task.

3.4.1 Orientation Texture

Measurements of preferred orientation textures have been conducted as part of this study in order to determine the degree of nonrandomness and variability present in relevant specimens. A brief description of the texture measurement process is as follows. The data-collecting X-ray scaler has a memory which permits the accumulation of new diffraction data while the previous collection is transferred to punched tape. The pole figure device operates in the spiral mode (reflection method) which involves the rotation of the sample in its plane (alpha angle) every 16 minutes while moving off the center 5° (beta angle).

Computer programs in BASIC language were written to manipulate the diffraction data gathered using the pole figure device on the diffractometer. The programs developed for the data analysis and plotting (called Poleft) are included as Appendix C and are annotated. The X-ray data were corrected for background and the strongest point assigned a value of 100. A Fourier series was fitted to the data points in groups and the beta angle then interpolated for each intensity value from 10 to 90 at intervals of 10. The program contains an algorithm which converts the polar coordinates to cartesian coordinates for plotting the pole figure. This data is written into a computer file which is utilized by a program called Polepl (see Appendix D) to plot the pole figure on a stereographic projection. An automatic X-Y plotter which permits conversational interaction during plotting was used.

Studies have been conducted on several aluminum alloy and titanium specimens cut from sheet stock. These specimens were used for technique

development and to determine the range of measured variables. Two pole figures made from a specimen cut from an aluminum sheet, 7075-T631, are shown. The (200) pole figure, Figure 14, indicates a maximum intensity (density of poles) in the center, falling off less rapidly in the direction of rolling than in the transverse direction. A random orientation of grains in the sample would lead to a uniform pole figure having a constant intensity level. In this case a tendency is present for grain orientations such that (200) planes in those grains are parallel to the sheet surface. The maximum pole density (100 relative units) lies in the center corresponding to the normal to the sample surface. The (111) pole figure for this specimen, Figure 15, shows a secondary maximum (50 units) in the center but the maximum intensities are at about 55° from the center in the transverse direction. This value is the angular distance between the (100) and (111) planes; the two pole figures are consistent with each other. This aluminum alloy sheet, therefore, shows a strong preferred orientation.

Pole figure determinations were made on several titanium sheets. A (10.1) pole figure made on a 50% reduced sheet is shown in Figure 16. The pole figure shows a four-fold symmetry with the maximum intensities occurring at about 35° from the center. Texture measurements were also made of the same sheet in the annealed condition, 1355°F (735°C), 5 min. The maximum intensity in the (00.2) pole figure, Figure 17, occurred in the center. In the (10.1) pole figure, Figure 18, the maximum occurred at about 50° from the center. Comparison of Figures 16 and 18 indicates the strong differences in texture that can be expected in titanium as a result of different mechanical and thermal treatments.

X-ray diffraction measurements were taken from one surface of the slice (see Figure 22) sectioned from the rejected aluminum ultrasonic reference block. The pole figures corresponding to reflections (200), (111), and (220) are included with this report. The axis of the block is located at the center of these pole figures. The (200) pole figure, Figure 19, shows two-fold symmetry with the maximum intensity in the center. The intensity falls off to less than 10 units at a deviation of 5 degrees from the axis. Secondary maxima of 40 are located at 180 degrees to each other at a deviation from the axis of approximately 25 degrees. The relatively high intensities of the (200) poles at the axis of the slice imply a high density of (200) poles on the cylindrical surface of the block. This axial orientation texture is very strong as indicated by the rapid decrease in pole density within 5 degrees of the axis.

The (111) pole figure, Figure 20, shows maxima at 35 and 55 degrees from the axial position. These maxima would be expected at these locations on the basis of the (200) pole figure. The (111) pole density at 55 degrees from the center shows pseudo four-fold symmetry indicating that the (200) preferred orientation in the center has a secondary preferred orientation and is not distributed randomly about the axial position. This preferred orientation of the (111) poles has also been noted in the residual stress measurements since the intensities of

peaks measured at other than zero inclination angle are found to vary with the rotation of specimens. The (222) peak is used with other diffraction peaks in obtaining the residual stress data.

The principal feature of the (220) pole figure, Figure 21, is the occurrence of maxima in restricted belts about 22.5 degrees from the center of the figure. These must be related to the (200) poles which reach secondary maxima in two large areas about 22.5 degrees from the center of the (200) pole figure. Secondary maxima of the (200) poles occur at 45 degrees and have four-fold symmetry. These are related to the very sharp maximum occurring in the center of the (200) pole figure.

This pole figure information suggests that this reference block has secondary preferred orientation around its axis. The texture must have occurred from early fabrication of the rod. Since ultrasonic attenuation is sensitive to crystal orientation in stressed crystals, then this texture may be contributing significantly to the ultrasonic response of the block. Variations, if any, of the texture throughout the block will be sought.

There is some scatter in the center of the pole figures which is due to grain size. Even with 0.6 in (15 mm) oscillation of the specimen during X-ray measurements, the scatter is largest at low beta angles but disappears when the beta angle has passed 20 to 25 degrees. At increasing beta angle for the same slits, a larger area of the specimen is covered by the X-ray beam. This effect may also be due to the grain shape, that is, the diffracting planes examined may have spread out further parallel to the surface of the specimen than in other directions if the grains are elongated in the surface plane.

3.4.2 Reference Block Microstructure

The aluminum reference block rejected by the manufacturer after fabrication was sectioned after preliminary acoustic inspection in order to examine the uniformity of metallurgical microstructure throughout the block. As indicated in Figure 22, the block was sectioned into three principal parts. The end containing the flat-bottomed hole was cut off at a length of 1.2 in (30 mm) and subsequently, a slice 0.16 in (4 mm) thick was taken from the surface opposite the flat-bottomed hole for texture measurements. The remaining block, 2.4 in (61 mm) long, was examined ultrasonically and then sectioned into two portions, each 1.2 in (30 mm) long. These two portions were ultrasonically inspected in detail. All cuts were carefully made perpendicular to the axis using a narrow, thin circular saw blade. The newly cut surfaces were then metallographically polished using a series of progressively finer abrasives, finishing with 40 μ in (1 μ m) diamond followed by MgO powder. Care was taken to minimize deviations from a flat surface and rounding at the edges.

Two of these new surfaces were examined metallographically. Several etching solutions were used. The results did not differ substantially.

Figure 23 is an optical micrograph of an as-polished surface (S2). Many voids and cavities are seen there. Etching the polished surface reveals the grain structure and other phases that are present in this alloy, Figure 24. The grain diameters generally are in the range from 4 to 20×10^{-4} in (10 μm to 50 μm). At longer etching times another feature emerges in many of the grains as shown in Figure 25. "Star-like" features appear within the grains and are probably due to composition variations arising from solidification structures that remain from the initial ingot stage. This surface (S2) was lightly polished mechanically and reexamined without further etching. Figure 26 shows the remaining grain boundary outlines and many examples of voids and second phase regions in the alloy. At higher magnification, details can be seen in several of the second phase regions marked as A in Figure 27. The discrete pitting reactions at the grain boundaries (rather than continuous, uniform etching) suggest that discrete precipitates lie along the boundaries in nonuniform distributions.

The microstructure seen on the section surfaces is believed typical of the entire block. It is complex and nonuniform, containing many voids, cavities, foreign phase regions, and possible inclusions. Some original solidification structure remains, including possible alloy composition gradients. These structures would be expected to affect ultrasonic wave propagation and the lack of homogeneity in structure would produce non-uniform ultrasonic response. Studies of other reference block specimens should be conducted to determine how frequently such nonuniform structures are found.

3.4.3 Ultrasonic Inspection of Rejected Block

The two 1.2 in (30 mm) blocks were inspected ultrasonically. They were scanned using a nominal 10 MHz longitudinal beam transducer in an immersion tank. Each was first scanned such that the area between the top surface of the block and the bottom surface was displayed. No acoustic anomalies were observed on these scans. It was suspected that the material was not uniformly attenuating. Therefore, a delayed presentation of the amplitude of the first back reflection was observed as the block was scanned. Water path distance was maintained at 3.0 in (7.6 cm), during the scanning operation. Scanning increments were set at 0.030 in (0.076 cm). Seventy-five scans were needed to traverse the 2 in (5 cm) blocks because of transducer beam spreading. Each block was scanned in two orthogonal directions. An arbitrary amplitude of +60 mV was chosen as the norm in checking for attenuation uniformity. Amplitude losses greater than 1/3, i.e., signals less than +40 mV were noted at several locations.

Signal amplitude increases (> 60 mV) were also noted, particularly on block 1, Figure 22. Waveform and spectrum photographs (Figures 28 and 29 respectively) were taken at particular locations using the techniques described in Section 3.3. Further information is given in Table 3. Using a nominal 5 MHz search unit, amplitude losses were less than 15% and no location information was quantified.

3.4.4 Residual Stress Measurements

The stress measurements were made using the method outlined in SAE TR-182, "Measurement of Stress by X-rays", [8]. However, the determination of the peak position is done differently. The alpha-1 peak is separated by using a modified method of that outlined by Gangulee [9] in the separation of $\alpha_1 - \alpha_2$ doublets. The new points near the center are fitted to a parabola and the parabola maximum is taken as the peak position. The annotated program used to calculate the stress is included as Appendix E.

The residual stress results from the sectioned block surfaces are summarized in Figure 22 and are shown in more detail in Appendix E. The first results were obtained by fitting a parabola to five equally spaced points. The measurements were made using the 222 diffraction indices using chromium radiation. The intensity of the peaks varied with the angle of inclination and with rotation of the specimen. The reason for this effect is quite evident in view of the texture shown in the (111) pole figure, Figure 20. The texture caused some problems, especially at the 15° angle of inclination, in getting useful data. It is felt that separation of the doublets will give better results in the interpretation of data with widely varying intensities. There seems to be a significant variation in residual stress measured on sectioned surfaces of this block. Further investigation of additional surfaces, of the effect of surface preparation, and of other materials is indicated.

3.5 Fabrication Considerations

Two areas related to the physical (non-metallurgical) fabrication of reference blocks are being studied. The first is a study of the critical dimensions in E 127 blocks. Arrangements have been made with the Dimensional Technology Section at NBS to inspect selected blocks for hole diameter, hole depth, surface finish of the hole bottom, parallelism of the hole bottom and top surface, and corner radius. Blocks tested in Task 3 that exhibit anomalous response and are available for destruction will be tested for anomalous physical dimensions. Further work in this area is deferred pending further progress on Task 3. In a related experiment, eighteen No. 5 blocks, six each with 0.50, 3.00 and 5.75 in (12.7, 76.2, and 146.0 mm) metal travel distance were machined at NBS with the E 12764 tolerances specified. The material was 7075-T651 aluminum alloy, of unknown origin, except that it was all from one heat. This temper was used because a supply of material from one heat was readily available, and hopefully metallurgical variables could be minimized. After the cylinders were machined, but before the flat-bottomed holes were drilled, the cylinders were inspected ultrasonically at 5 MHz to determine material uniformity. Among sets of nominally identical blocks, the back surface response along the cylinder centerline varied by no more than 10 percent among the six blocks. After the flat-bottomed holes were drilled, the blocks were cleaned and plugged temporarily per E 127, and inspected ultrasonically at 2.25, 5.0, 10.0, and 15.0 MHz. The results of these tests are given in Table 4. At 5 MHz, the scatter between similar blocks

was always less than ± 7 percent, most of which is attributed to material nonuniformity. At 2.25 MHz, the scatter is even less, but at 10 and 15 MHz it is somewhat greater. It therefore appears that, at least in this case, the machining of the flat-bottomed holes did not introduce significant disparity into the measurements. Dimensional metrology will be used to determine if the dimensions of these blocks are significantly more uniform than required by the tolerances as specified in ASTM E 127. Blocks with No. 3 and 8 holes will be similarly fabricated and checked.

A second subtask relating to fabrication is a feasibility study of making two piece blocks. If it is determined that inaccuracies in the dimensions of the flat-bottomed hole are a cause of ultrasonic variability, it may be beneficial to fabricate the reference block from two cylinders, one solid and one containing a through hole. This would greatly facilitate both the machining and metrology processes. The two cylinders would then be connected by an ultrasound-transmitting bond, such as wringing or diffusion bonding. The latter has been reported to be feasible for titanium, e.g. [4], but as yet no work on this has been done on the current program. Some experiments have been performed on wrung pieces of steel, aluminum, and quartz, the latter with a view toward Task 8. Test pieces with very flat surfaces (0.5 fringe or better) and very fine surface finishes (2 μ in or better) were fabricated and wrung together using dimensional gage block techniques. Ultrasonic data was taken at 5 MHz, and in some cases in the steel and quartz, the reflected energy received from the interface was less than 10 percent of that received from the back surface. No success has been achieved with the aluminum. This work will be continued or dropped, depending on whether or not hole geometry is found to be a significant cause of variability.

3.6 Effects of Ultrasonic Measuring Systems

Using current standardization procedures, consistent quantitative measurements from various systems are not possible unless the ratio of responses from two references is the same on both systems. For example, an area-amplitude set of blocks that is linear on the block manufacturer's system must also be linear on the user's system in order to be useful. To determine what effects different test instruments have on the relative response of aluminum blocks, an intercomparison of data was made between NBS and the Reynolds Metals Company. Data was taken on three distance-amplitude sets using the same 5 MHz, 0.375 in (9.5 mm) diameter quartz search unit and the same test procedures, but with different instruments, although the same model.

The data from the two labs are presented in Table 5. The variability between systems, including operator error, is in general less than 10 percent.

In addition, three runs were made at NBS on one set of blocks using the same test system but with different operators in an attempt to quantify

operator error. This data is given in Table 6. The maximum deviation between readings was less than 5 percent of the average of three readings except for one point down to the values where the minimum resolvable increment was greater than 5 percent of the reading.

3.7 Single Material Standard

The feasibility of using a material with no grain structure, high homogeneity and good inspectability such as fused quartz or crown glass, as a single material standard is being considered. This idea was well received by the attendees at the NBS NDE Public Review and Workshop in December 1974. This approach might require the development of transforms relating the acoustic impedance, attenuation, and sound speeds of the master blocks and structural materials. Significant effort on this task is planned.

3.8 ASTM Participation

The NBS investigators have joined and become active in ASTM Committee E-7 on Nondestructive Testing, Sub Committee E-7.06 on Ultrasonics, and particular section E-7.06.02 on Aluminum Reference Blocks. Close contact has been maintained with the chairman of E-7.06.02 and considerable consultation has taken place regarding the revision of E 127 scheduled for ballot by E-7.06 and E-7 later this year. Experiments were performed to verify the validity of using a universal distance-amplitude curve to replace the three curves currently used (Figure 6 of [1]). If different standardization points are used for different size blocks, their responses can be compared to a single curve of higher amplitude than the number 3 and number 5 curves in the current document. In the current document, the maximum response expected from a number 3 hole is only 12 percent of the scope vertical linear limit, and resolution becomes a problem. The data from three sets of blocks, one each No. 3, 5, and 8, when plotted on a universal distance-amplitude curve basis, are shown in Figure 30. The scatter between these data appears to be no worse than the scatter between data from blocks of the same size (Figures 4-12). Continued, long-term participation in activities of these groups is planned.

4. IMPORTANT CONCLUSIONS TO DATE

Based on the work completed to January 1975 the following conclusions are drawn:

- 1) No previous work has isolated the cause of block variability. The problems of dimensional, metallurgical and fabrication considerations must all be attacked. Work in the United Kingdom has suggested it would be difficult to fabricate blocks with less than ± 1 db variability but that this tolerance can be achieved with assigned correction factors ("calibration").

- 2) Among the blocks evaluated to date, the "average" variation between nominally identical aluminum blocks is about 20-30 percent, but variations as high as 700 percent have been recorded.
- 3) Metallurgical studies were conducted on an aluminum block rejected by the manufacturer during fabrication. The block contained a high degree of preferred orientation texture, probably occurring as a result of the fabrication processing of the rod from which the block was made. The block microstructure was complex; voids, second phase regions and chemical concentration variations were all present. Significant variations in residual stress in this block were also found. All these factors probably contribute to the measured variation from -50 to 25 percent around the average back surface ultrasonic response of this block.
- 4) Efforts to manufacture two-piece blocks wrung together have met with mixed success. Some success has been achieved with steel and quartz, little with aluminum. One-piece aluminum blocks have been fabricated at NBS from a uniform lot of material. The spread among six nominally identical blocks was less than 10 percent for three different sets.
- 5) The variability between data taken by three operators using the same blocks and the same equipment was measured to be less than about 5 percent. The deviations between readings from two operators using the same blocks and the same search unit but different systems was less than 10 percent.

5. ACKNOWLEDGEMENTS

The following people have made helpful contributions to this program. Their assistance is gratefully acknowledged.

Gary D. Boswell and Robert G. Elmer, Engineering Mechanics Section, NBS - laboratory assistance.

Martin Greenspan, Carl Tschiegg, and Frank Breckenridge, Sound Section, NBS - consultation on equipment and transducers.

Carlton A. Burley and Dave Feitig, Reynolds Metals Company - technical consultation on testing procedures and ASTM E 127.

Michael A. Kearney, Automation Industries - consultation on equipment and aluminum blocks.

In addition reference blocks have already been loaned by the following companies for evaluation under task 3:

Naval Research Laboratory
Reynolds Metals Company
Westinghouse Electric Corporation
Wyman-Gordan Company

Sponsorship and financial assistance have been received from the Air Force Materials Laboratory, National Aeronautics and Space Administration (Lewis Research Center), and the Army Materials and Mechanics Research Center. These organizations were technically represented by Lee R. Gulley, Jr., Robert L. Davies, and George Darcy, respectively. The work was administered through the Air Force Materials Laboratory with Lee R. Gulley, Jr. as project monitor.

6. REFERENCES

- [1] Anon., Standard Recommended Practice for Fabricating and Checking Aluminum Alloy Ultrasonic Standard Reference Blocks, ASTM Designation E 127-64, 1974 Annual Book of ASTM Standards, Part 11 (Am Soc Test Mat, Philadelphia, 1974).
- [2] Anon., Standard Recommended Practice for Fabrication and Control of Steel Reference Blocks Used in Ultrasonic Inspection, ASTM Designation E 428-71, 1974 Annual Book of ASTM Standards, Part 11 (Am Soc Test Mat, Philadelphia, 1974).
- [3] Millman, I., An Improved Facility for the Calibration of Aluminum Alloy Ultrasonic Reference Blocks, Report No. AQD/NDT1369, AQD Labs, Harefield, Uxbridge, Middlesex, U.K.
- [4] Kettering, D.D., Nondestructive Testing Calibration Procedures, Quality Control Lab. Report No. 027160. Grumman Advanced Development Report.
- [5] Chaskelis, H.H., Transducers-Fact and Fiction, Non-Destructive Testing, p 375, December 1971.
- [6] Reynolds, P.M. (editor), The Future of Ultrasonic Spectroscopy, Proceedings, October 14, 1970.
- [7] McElroy, J.T., Identification and Measurement of Ultrasonic Search Unit Characteristics, Automation Industries, Inc. Research Division TR 66-5, April 1966.
- [8] Christenson, A.L., Measurement of Stress by X-rays, Society of Automotive Engineers, Inc., TR-182 (1960), as corrected by errata sheet dated March 11, 1964.

[9] Gangulee, A., Separation of the $\alpha_1 - \alpha_2$ Doublet in X-ray Profiles,
J. Appl. Cryst. 3, 272 (1970).

Table 1 - Characteristics of Ultrasonic Search Units

Nominal Center Frequency	Crystal Diameter		Measured Y ₀ [†] Point		Transducer Type	Serial No.
	MHz	in	mm	in		
2.25	0.50	12.7	2.5	64	A306	3529
5.0	0.50	12.7	5.0	127	A309	3042
10.0	0.25	6.4	2.5	64	A312	4263

Table 2 - Standardization Points for Aluminum Blocks

Block Hole Size		Test Frequency MHz	Ball Diameter		Amplitude v
in	mm		in	mm	
0.047 (#3)	1.19	2.25	0.0625	1.588	1.20
0.047	1.19	5.0	0.1875	4.762	1.20
0.047	1.19	10.0	0.2812	7.144	0.60
0.078 (#5)	1.98	2.25	0.1250	3.175	1.28
0.078	1.98	5.0	0.4375	11.112	1.20
0.078	1.98	10.0	0.6250	15.875	0.60
0.125 (#8)	3.18	2.25	0.3125	7.938	1.20
0.125	3.18	5.0	1.0000	25.400	1.20
0.125	3.18	10.0	1.0625	26.988	0.58

Table 3 - Rejected Block Response

Block	Location No.	Figure No.	
1	(1)	28 (a)	"normal" area (60 mV peak)
1	(2)	28 (b)	amplitude loss (36 mV peak) 40% loss in crosshatched area
1	(3)	28 (c)	amplitude gain (65 mV peak)
1	(4)	28 (d)	amplitude gain (75 mV peak)
2	(1)	29 (a)	"normal" area (60 mV peak)
2	(2)	29 (b)	amplitude loss (30 mV peak) 50% loss in crosshatched area
2	(3)	29 (c)	amplitude loss (50 mV peak) 15% loss

Equipment Settings:

Pulser/Receiver:

Rep Rate: #3	Filter: 3
Voltage: (150; .1)	Gain: 26.5
Damping: min.	

Spectrum analyzer

C.F.: 10 MHz	Gain: linear
B.W.: 100 kHz	lmV/div x .25
Atten: 0	
Filter: 0	

Table 4 - Ultrasonic Response of NBS Homemade 7075-T651 Blocks.

Block Size and Number	Ultrasonic Response, volts			
	Test Frequency, MHz			
	2.25	5.0	10.0	15.0
5-0050-1	1.00	1.00	0.500	0.300
-2	1.02	1.00	0.530	0.320
-3	1.02	1.02	0.530	0.325
-4	1.02	1.02	0.530	0.315
-5	1.05	1.01	0.540	0.300
-6	1.03	0.99	0.500	0.270
5-0300-1	1.19	0.450	0.500	0.245
-2	1.27	0.475	0.550	0.305
-3	1.30	0.480	0.570	0.325
-4	1.22	0.455	0.500	0.250
-5	1.20	0.425	0.470	0.225
-6	1.20	0.420	0.480	0.240
5-0575-1		1.32		
-2		1.30		
-3		1.40		
-4		1.34		
-5		1.40		
-6		1.30		

Table 5 - Results of Data Intercomparison on Ultrasonic Blocks. Search Unit-5 MHz, 0.375 in quartz (SN 50A 1338) Water Distance = 3.5 inches.

Metal Distance (Block)	#3 Blocks		#5 Blocks		#8 Blocks	
	Lab A	Lab B	Lab A	Lab B	Lab A	Lab B
STD PT-0050	100	100	100	100	100	100
-0075	83	80	84	76	83	75
-0100	67	67	67	69	78	65
-0125	54	58	56	48	58	54
-0175	37	40	38	33	45	38
-0225	27	25	30	24	33	25
-0275	20	23	20	21	22	19
-0325	16	17	16	15	18	16
-0375	12	13	14	15	15	12
-0425	11	10	11	11	12	9
-0475	9	9	10	9	10	8
-0525	8	7	8	6	10	6
-0575	7	5	7	6	9	6

Table 6 - Evaluation of Operator variability. Block set 150-3 (#5 blocks),
5 MHz 0.375 in quartz search unit.

Block No.	Operator A	Operator B	Operator C	Avg.	Spread Among 3 Runs	Spread Avg. %
5-0050	100	100	100	100	-	-
-0062	88	86	88	87.3	2	2.3
-0075	84	80	80	81.3	4	4.9
-0088	75	72	72	73	3	4.1
-0100	67	66	65	66	2	3.0
-0125	56	54	55	55	2	3.6
-0175	38	36	37	37	2	5.4
-0225	30	29	29	29.3	1	3.4
-0275	20	21	21	20.7	1	4.8
-0325	16	16	17	16.3	1	6.1
-0375	14	13	13	13.3	1	7.5
-0425	11	11	11	11	0	0
-0475	10	10	9	9.7	1	10.3
-0525	8	7	8	7.7	1	13.0
-0575	7	6	7	6.7	1	14.9

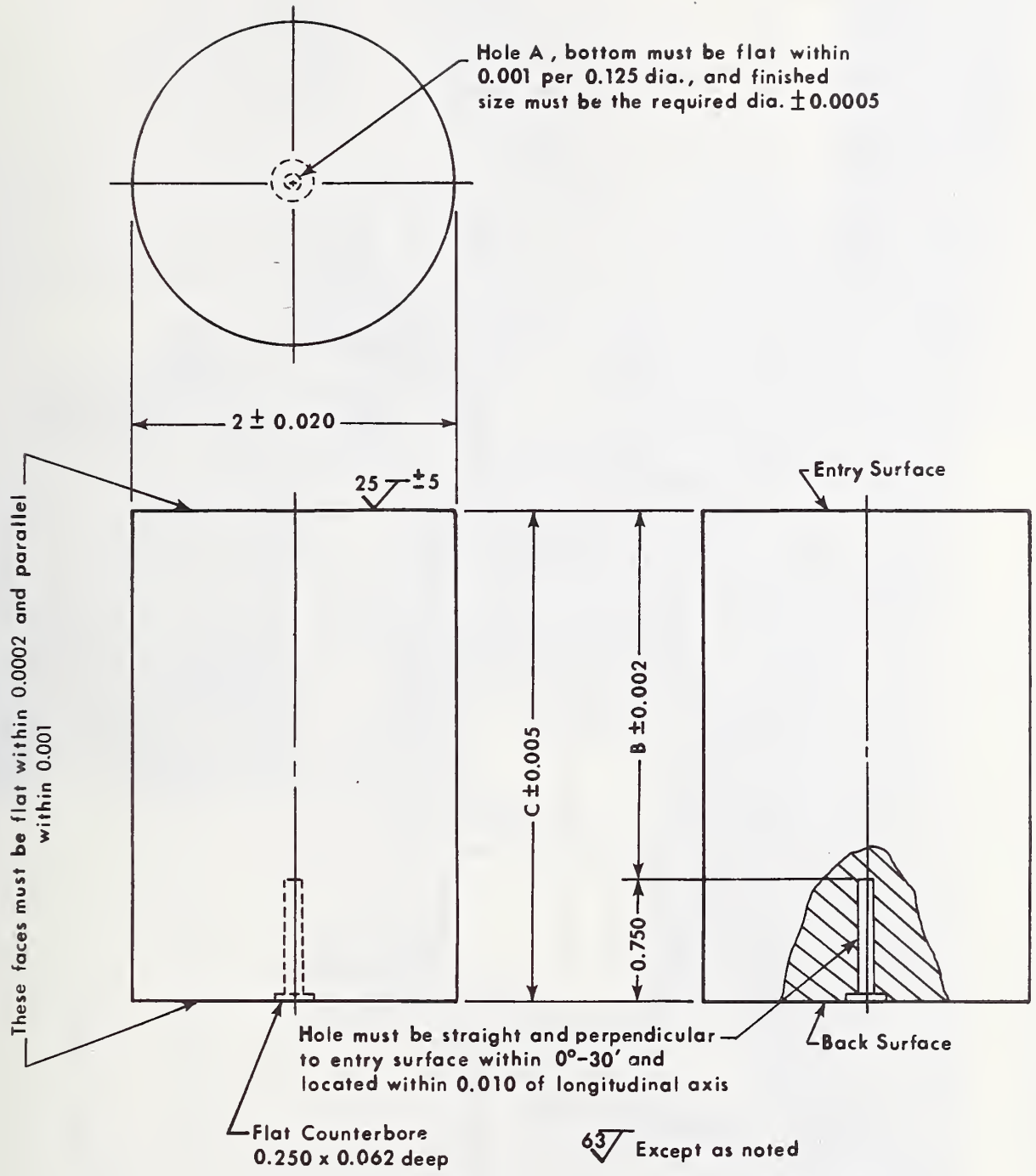

Figure 1 - ASTM E-127 ultrasonic standard reference block.
All dimensions in inches (1 in = 25.4 mm).

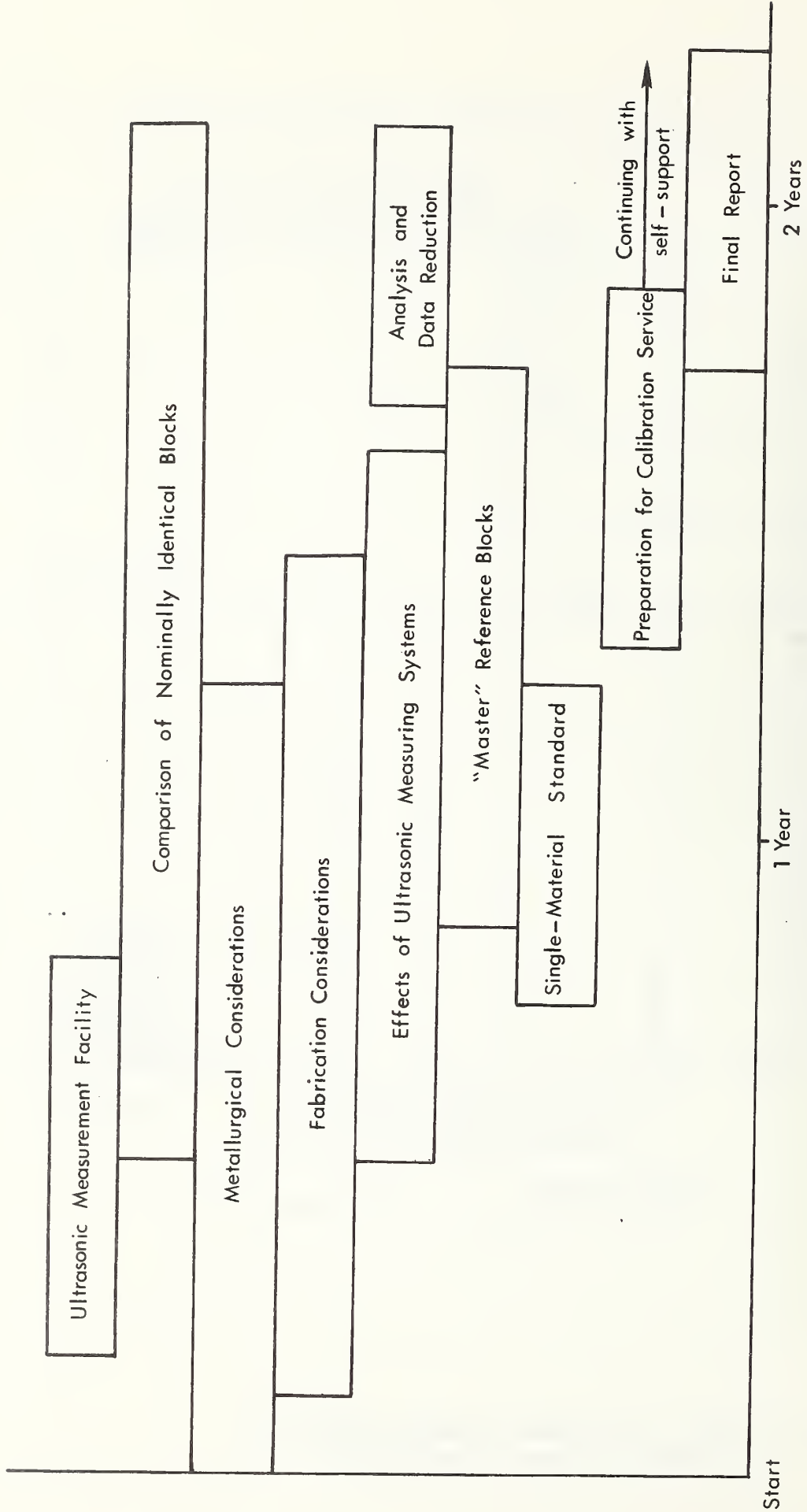

Figure 2 - Estimated Program Timetable

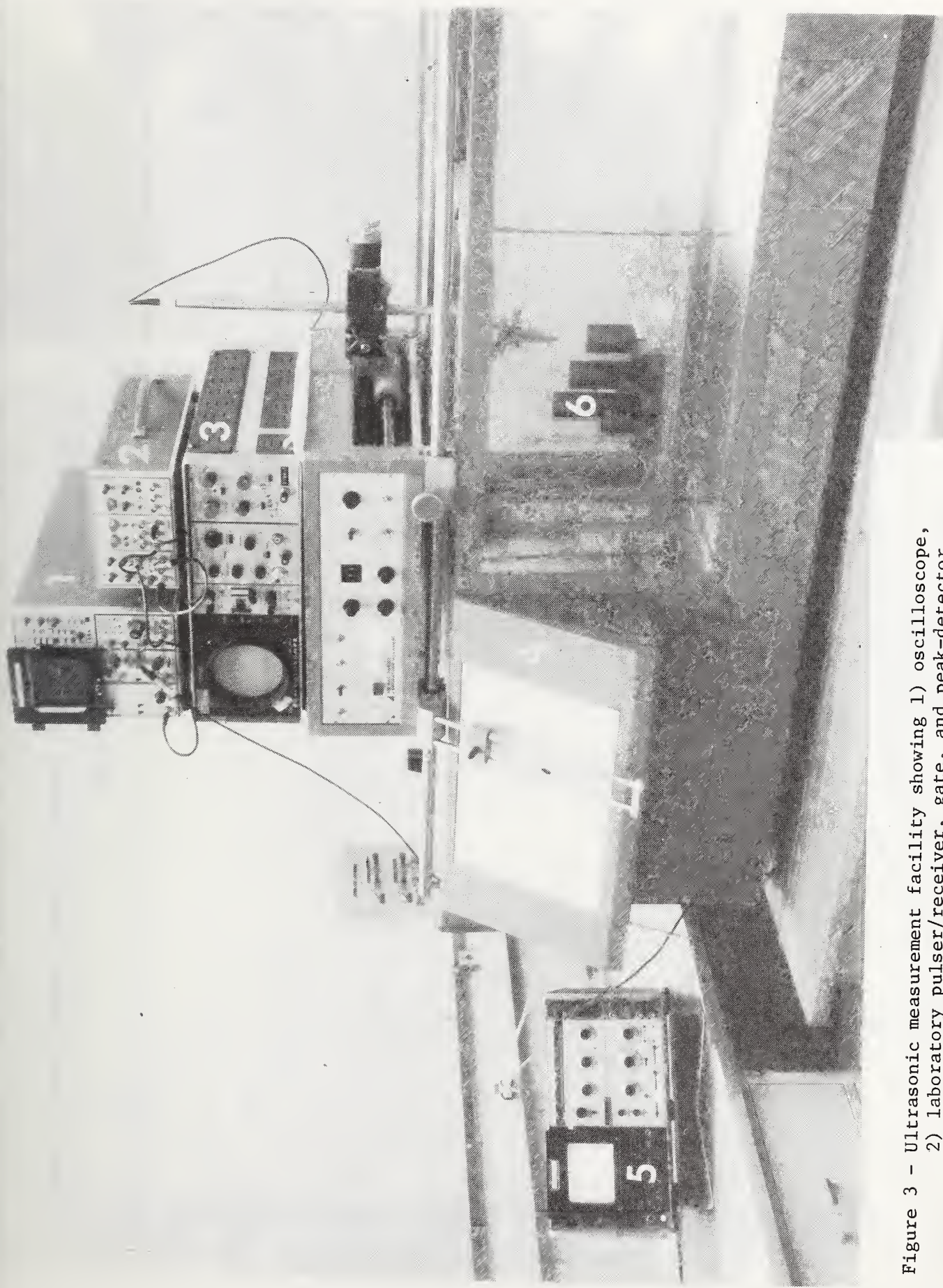

Figure 3 - Ultrasonic measurement facility showing 1) oscilloscope, 2) laboratory pulser/receiver, gate, and peak-detector, 3) flaw detector, 4) immersion system, 5) spectrum analyzer, and 6) ultrasonic standard reference blocks.

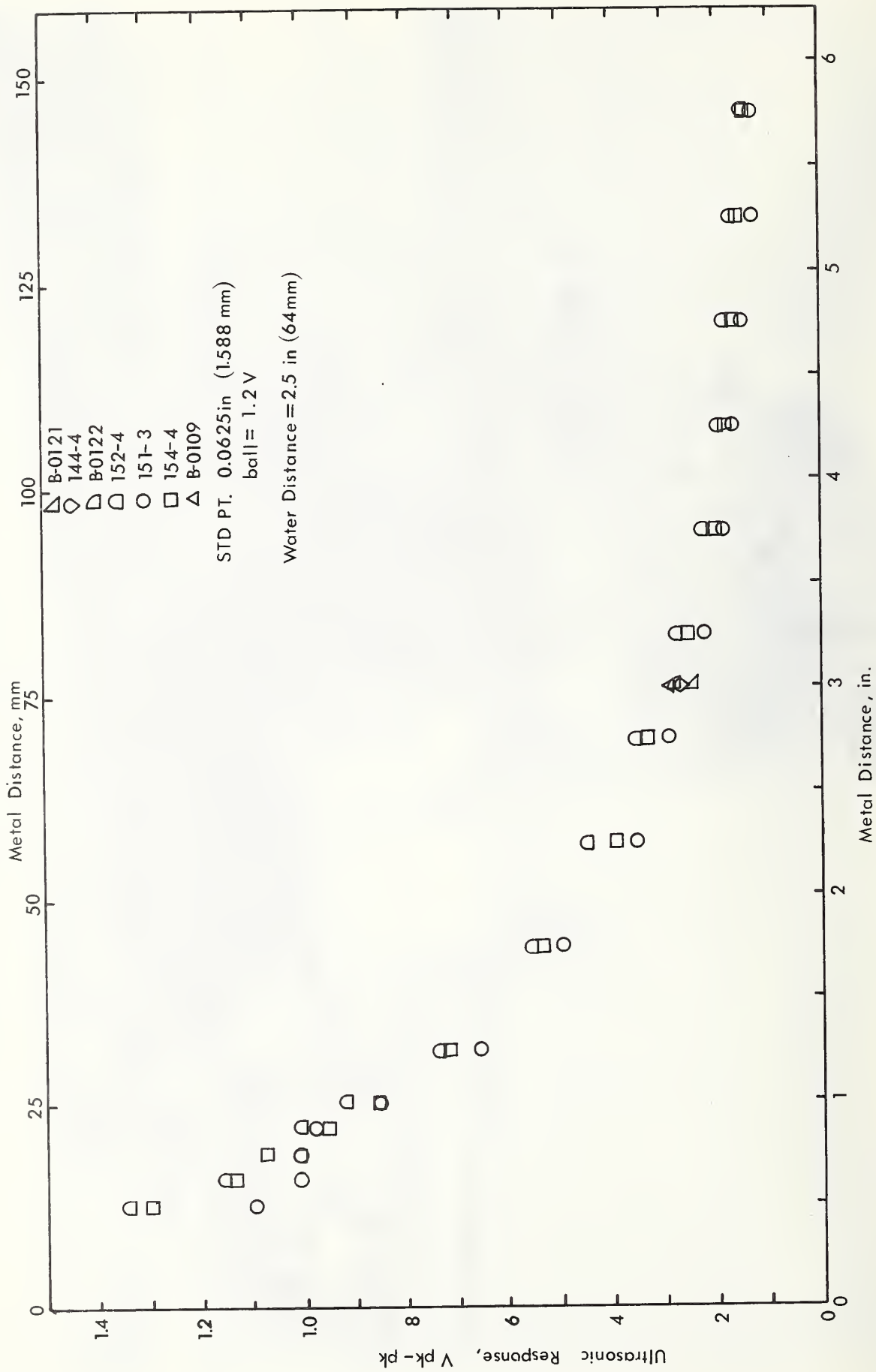

Figure 4 -- Distance -- amplitude data for No. 3 blocks at 2.25 MHz

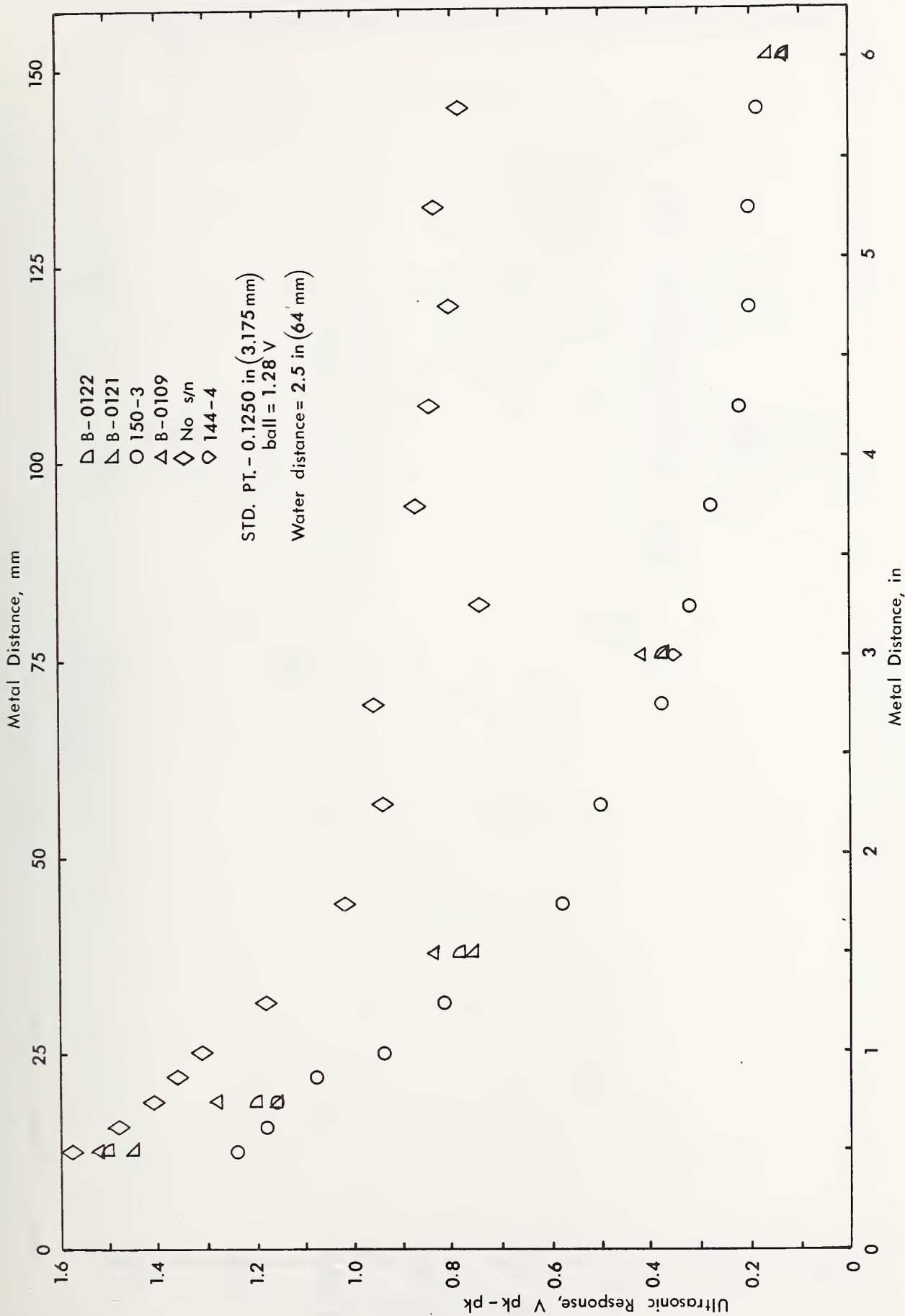

Figure 5 - Distance - amplitude data for No. 5 blocks at 2.25 MHz.

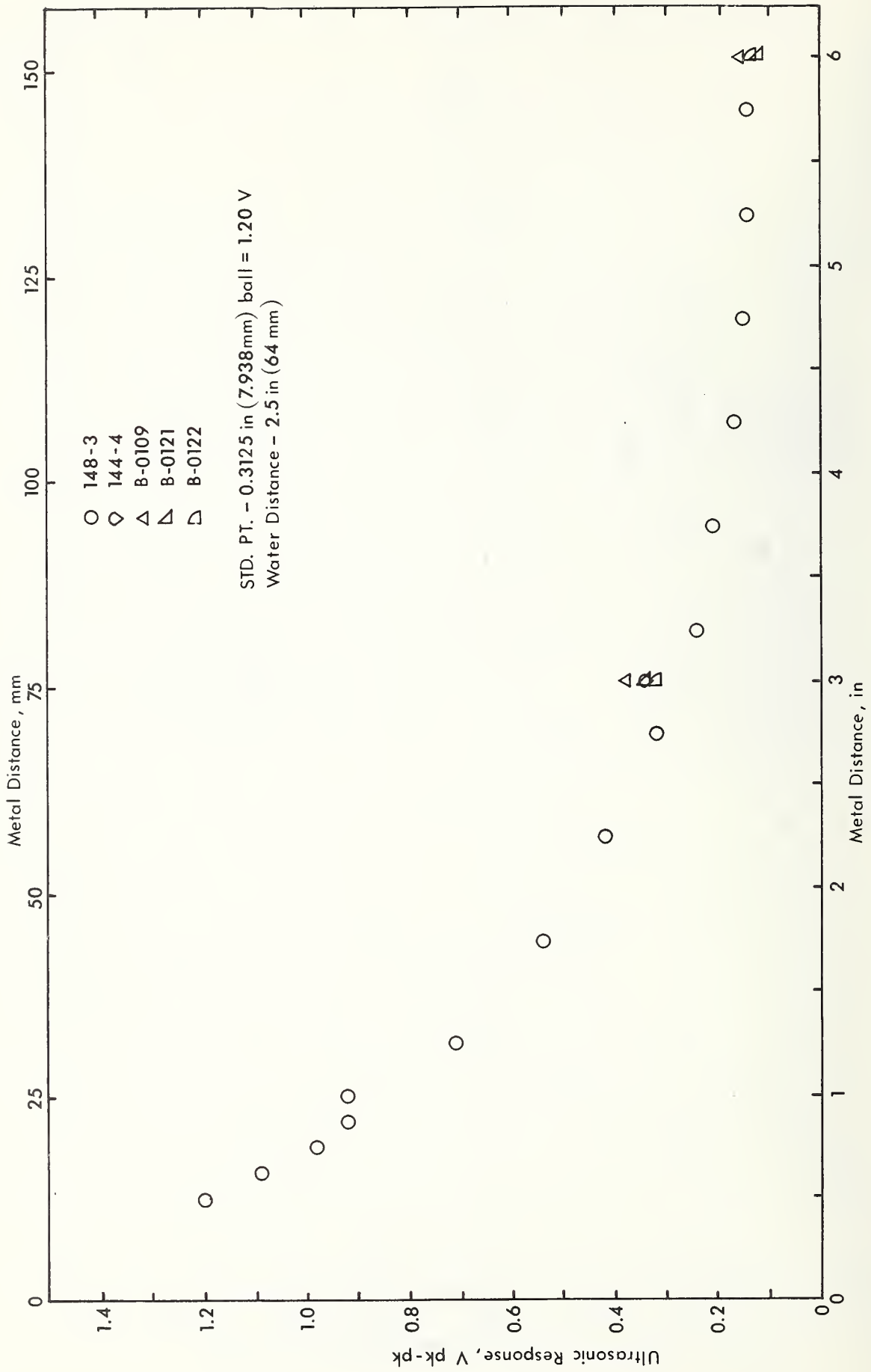

Figure 6 - Distance - amplitude data for No. 8 blocks at 2.25 MHz.

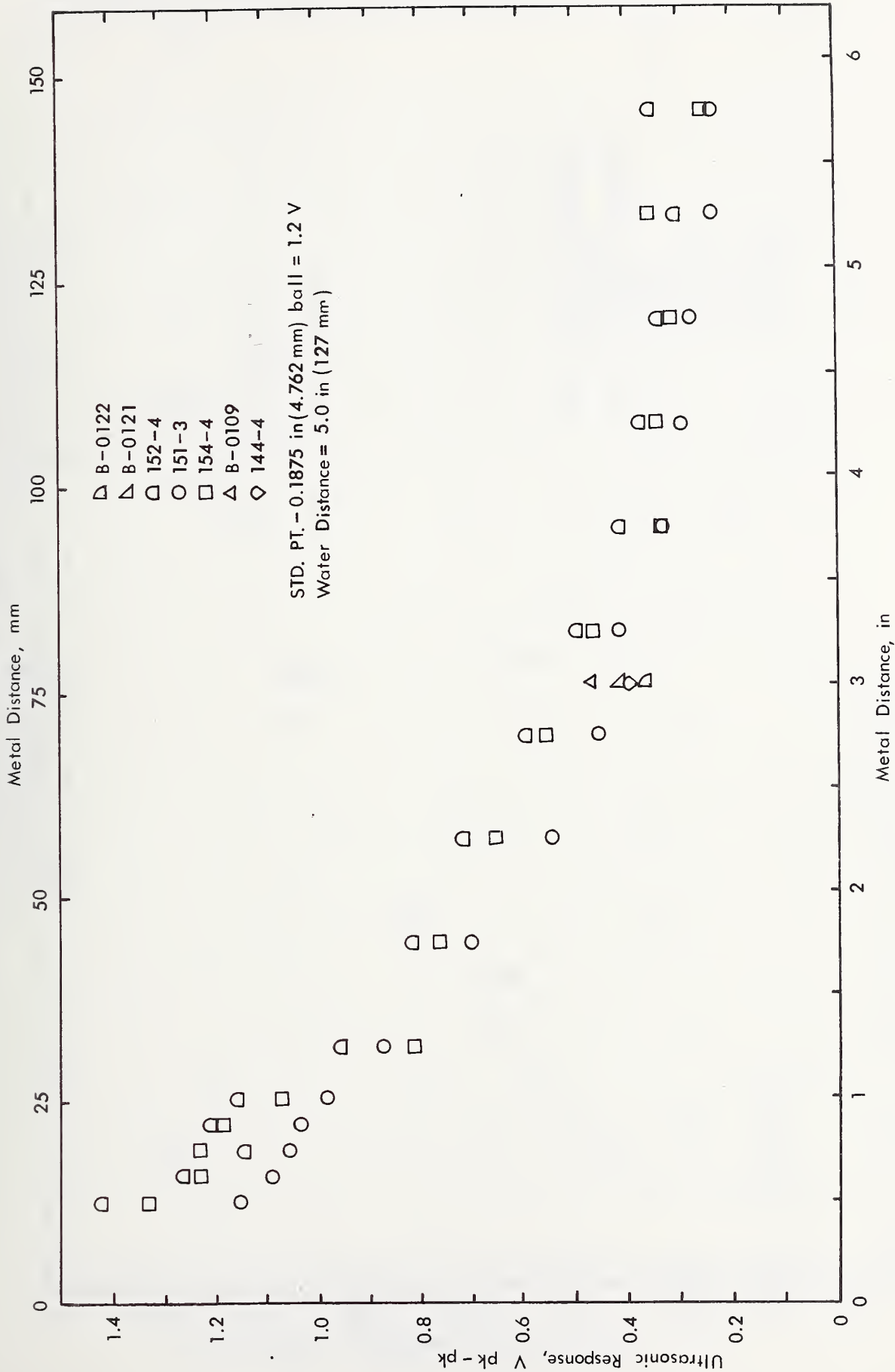

Figure 7 - Distance-amplitude data for No. 3 blocks at 5.0 MHz.

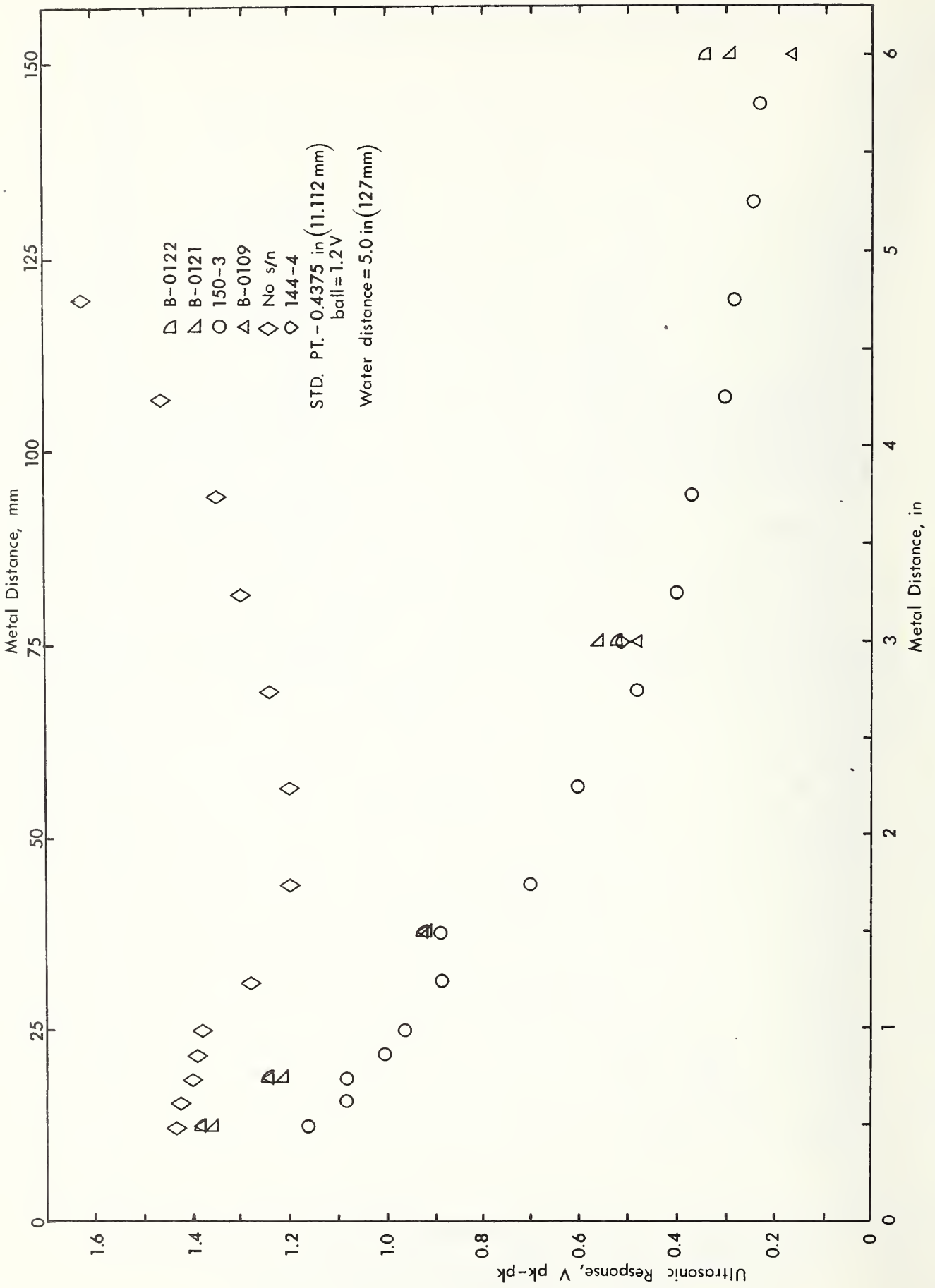

Figure 8 - Distance-amplitude data for No. 5 blocks at 5.0 MHz

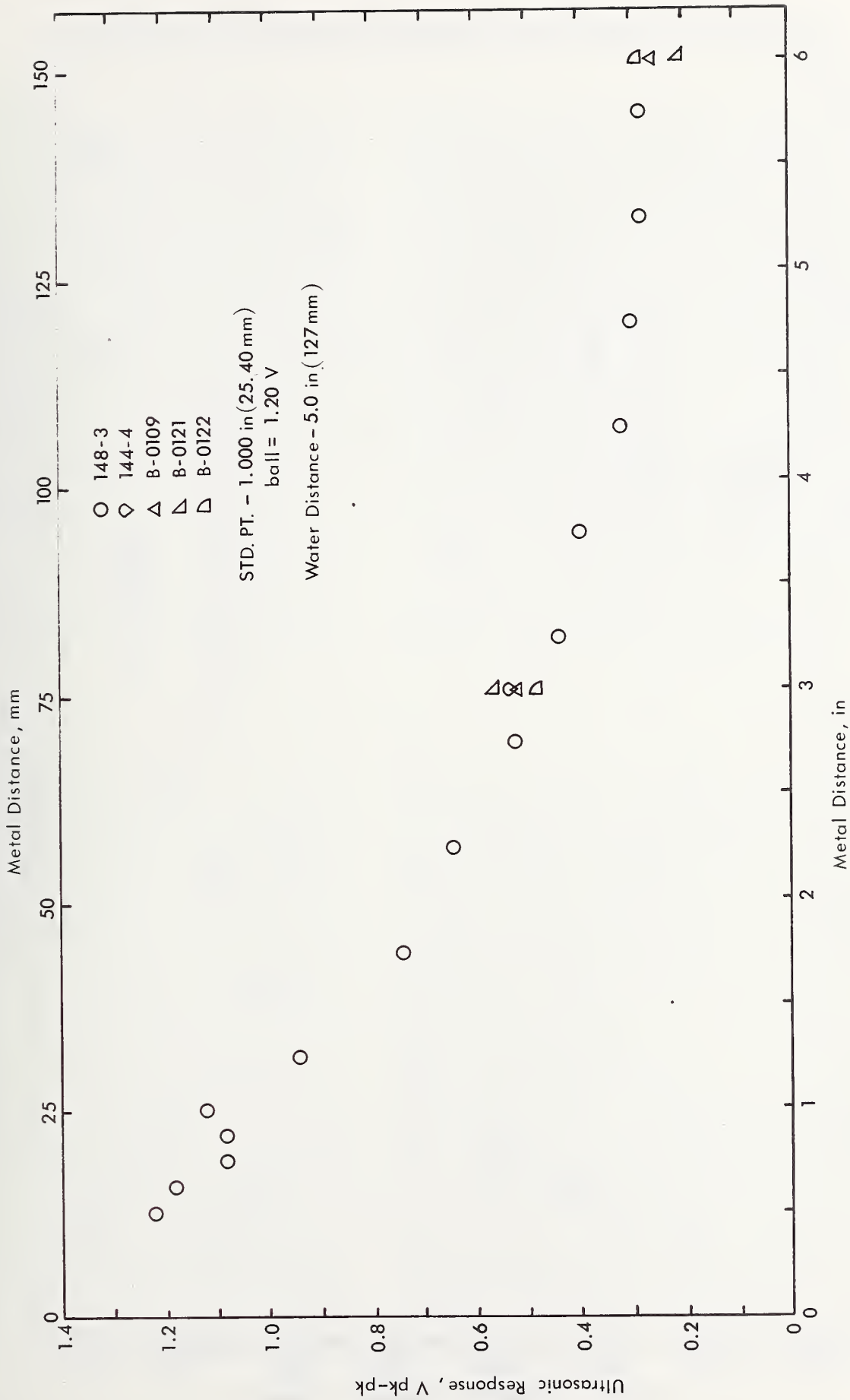

Figure 9 - Distance - amplitude data for No. 8 blocks at 5.0 MHz.

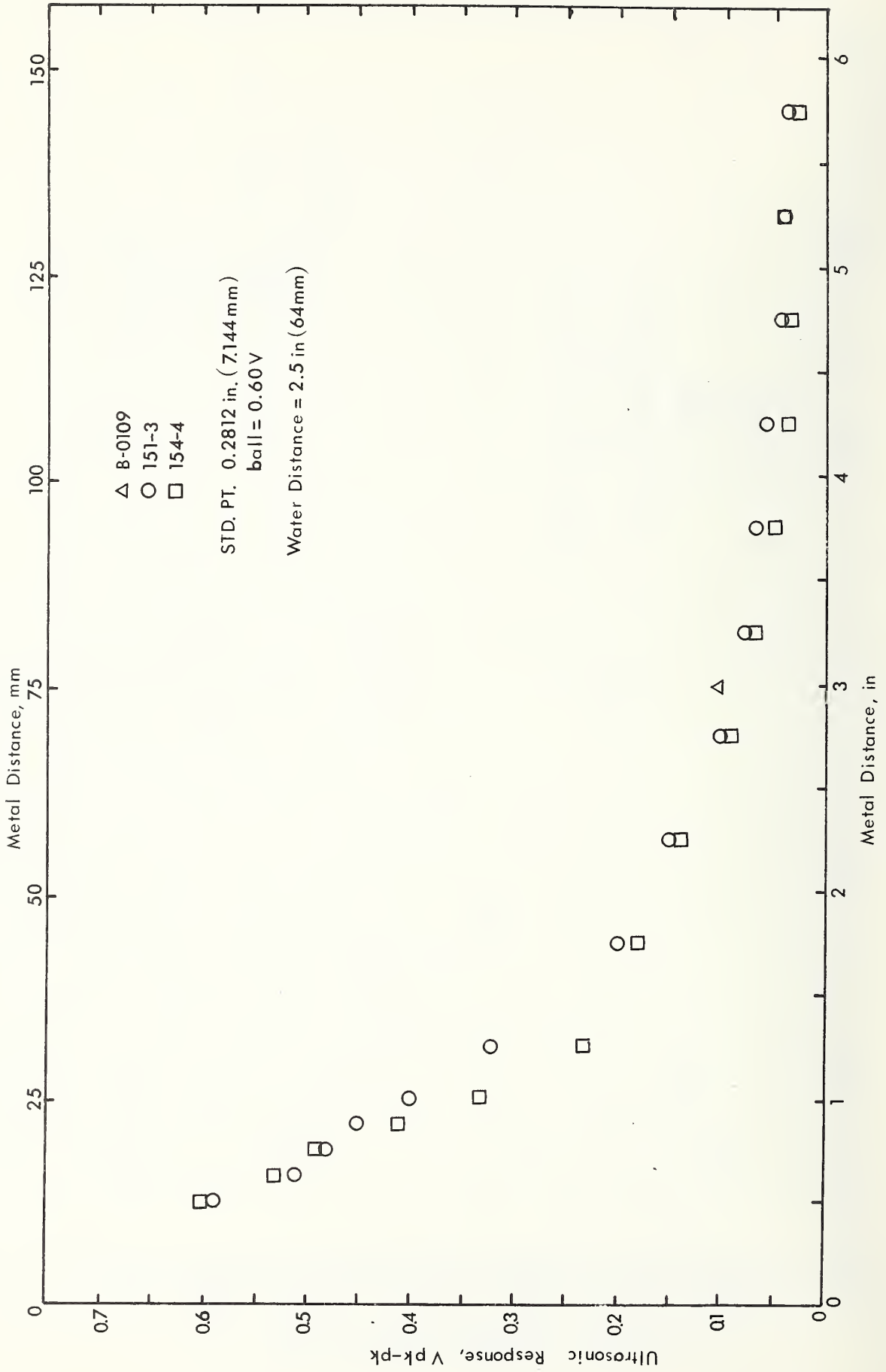

Figure 10 - Distance - amplitude data for No. 3 blocks at 10 MHz.

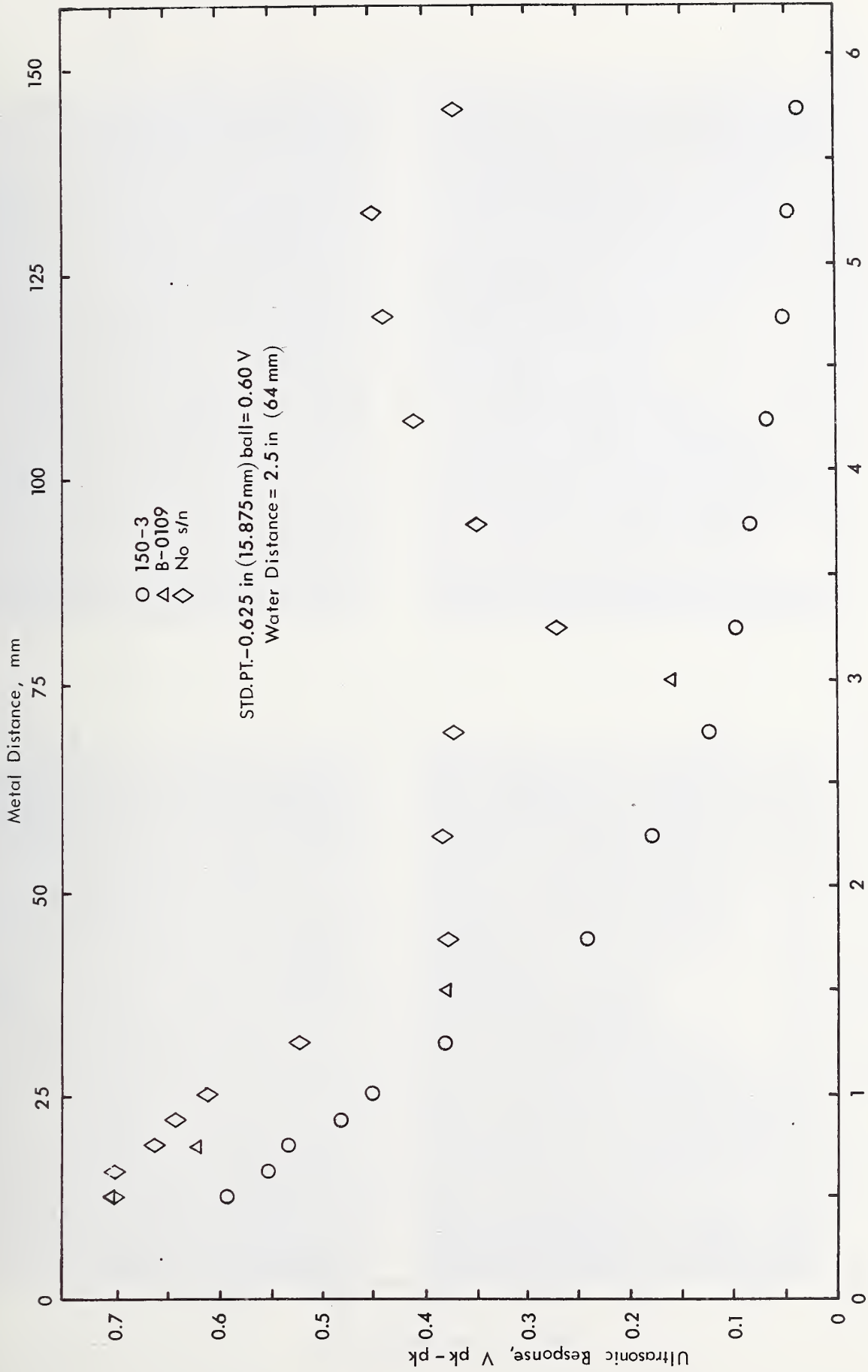

Figure 11 - Distance-amplitude data for No. 5 blocks at 10 MHz.

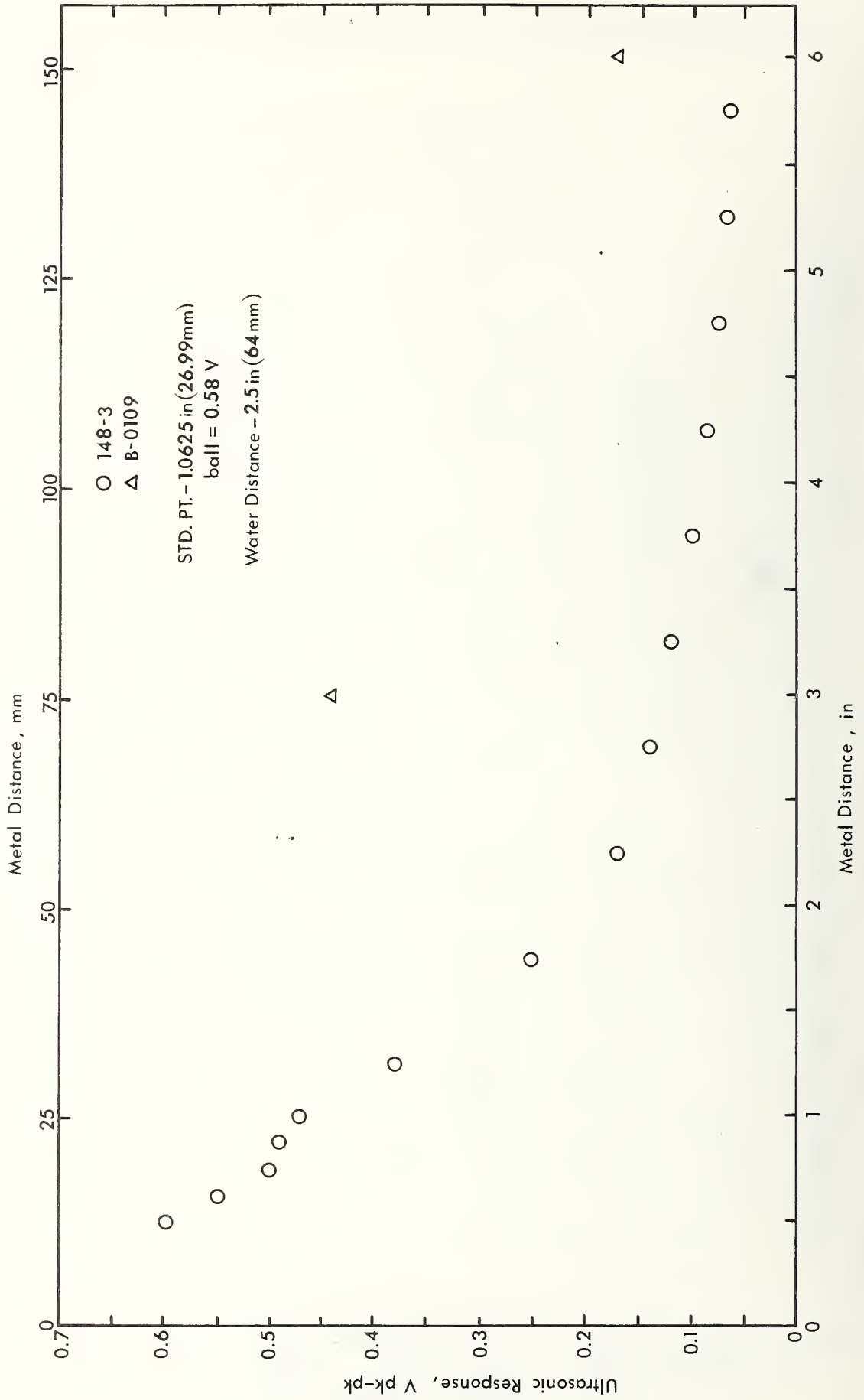
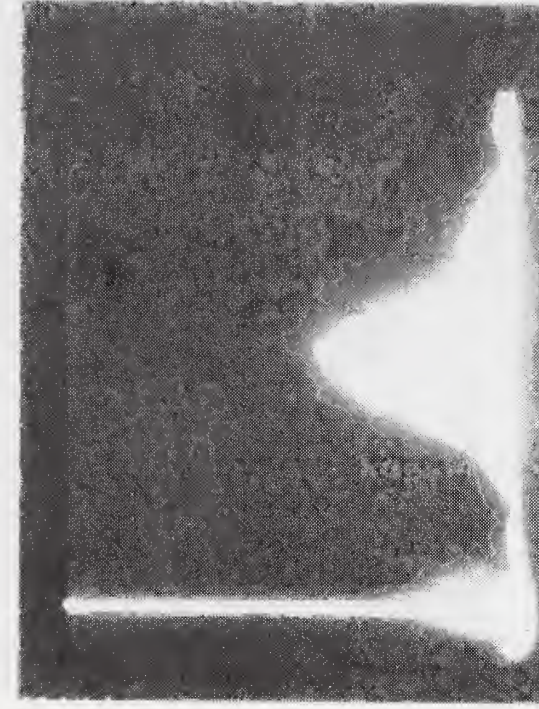
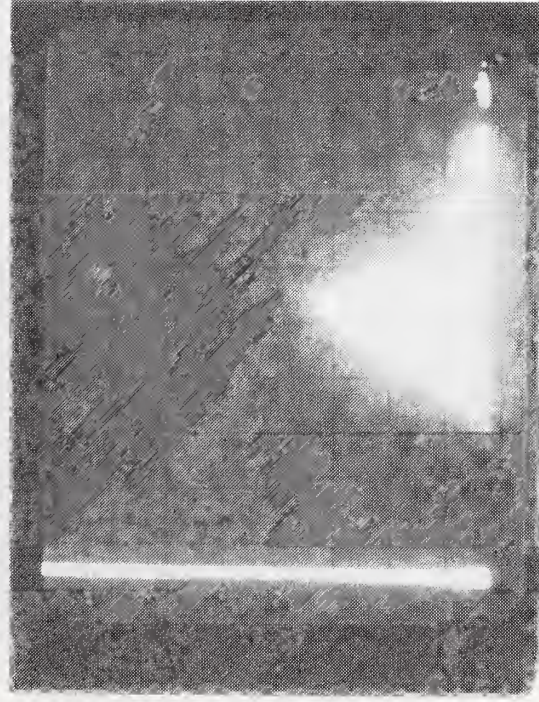
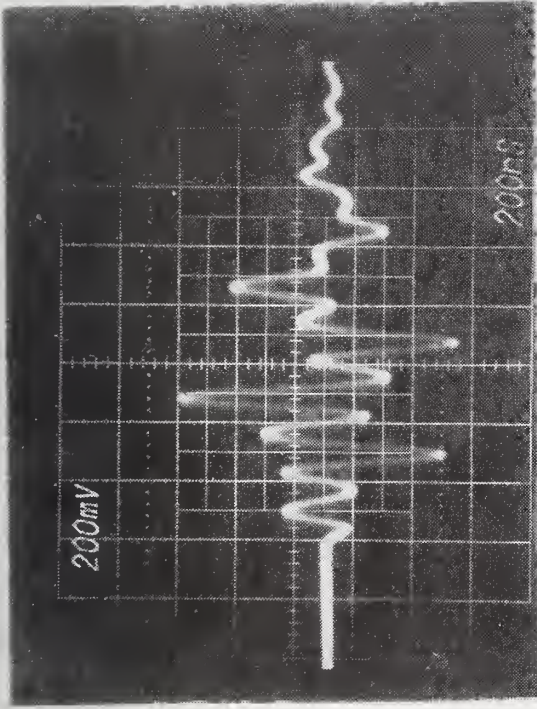
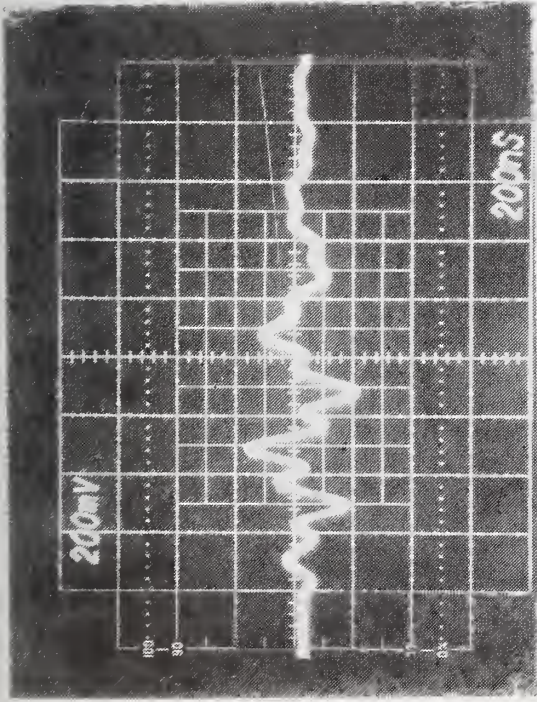

Figure 12 - Distance - amplitude data for No. 8 blocks at 10 MHz.



(a)
150-3, 2.25 MHz

(b)
No S/N, 2.25 MHz

Figure 13 - RF signals and spectra from two nominally identical 5-0275 reference blocks at three frequencies.

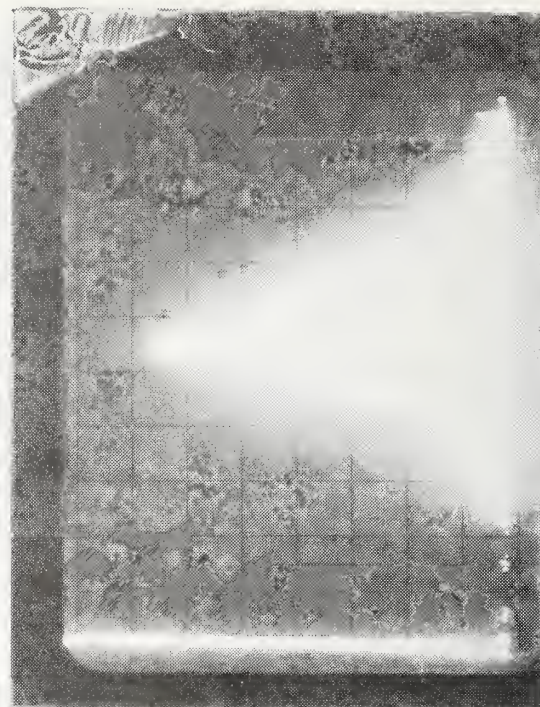
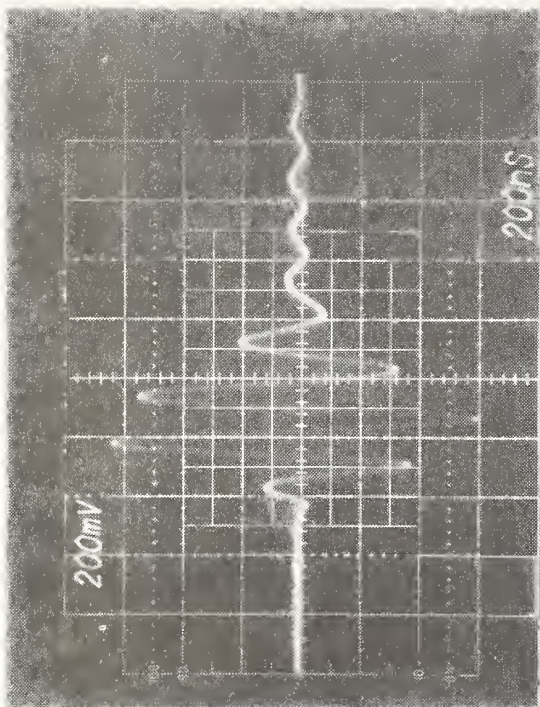
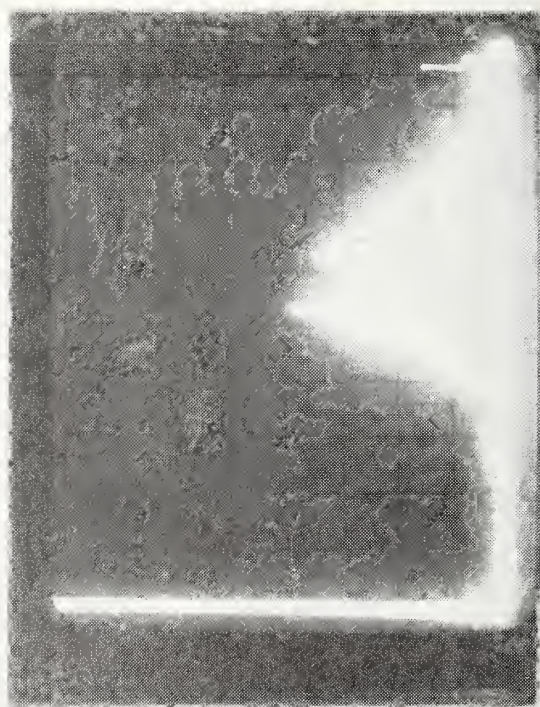
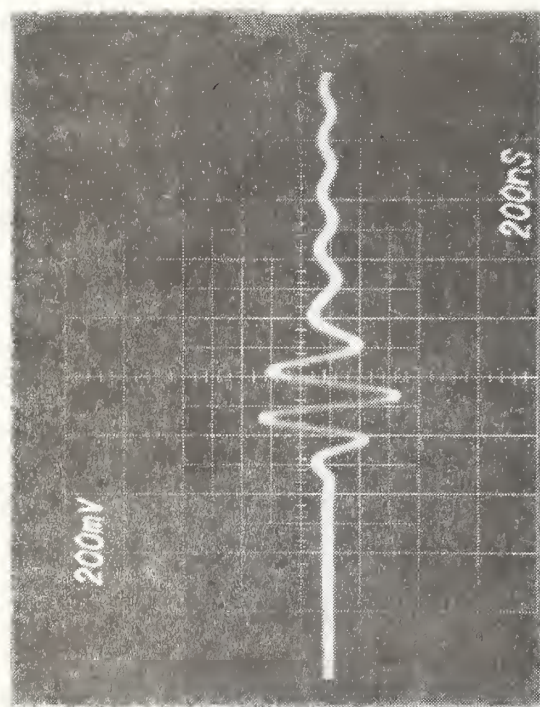
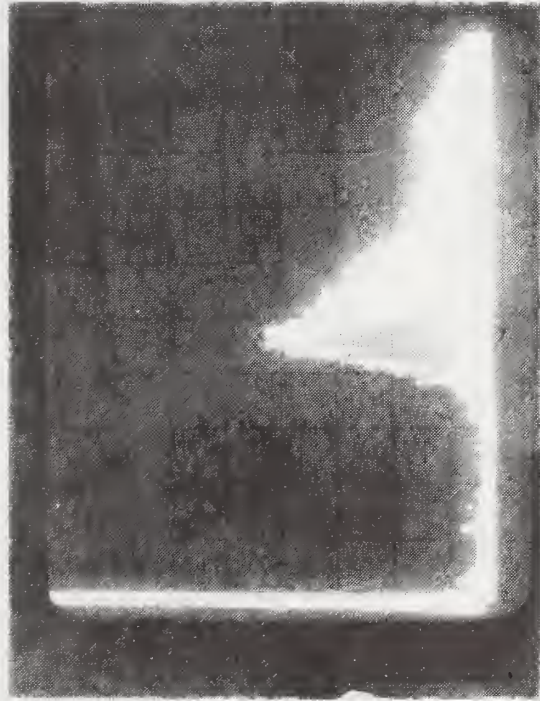
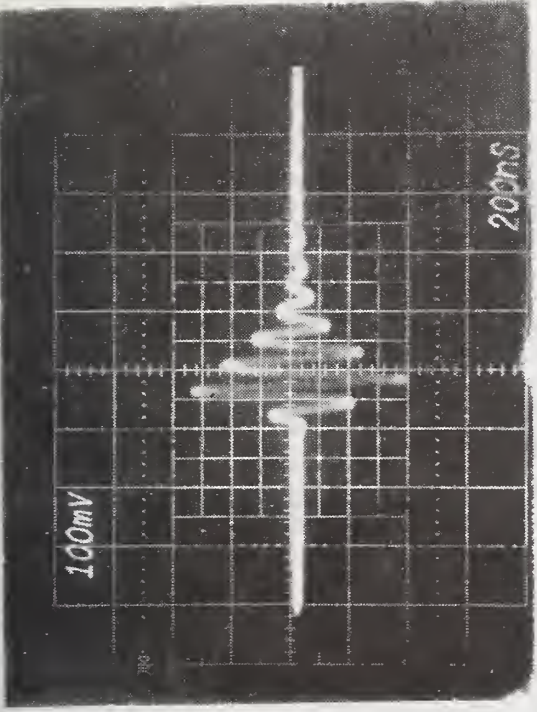
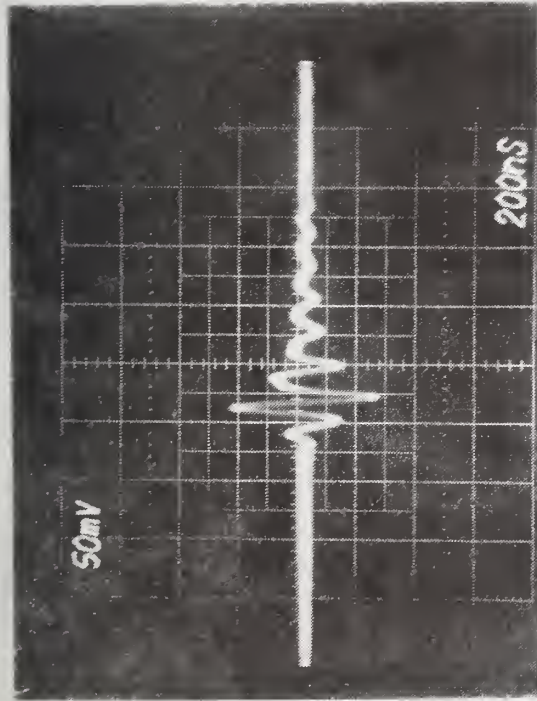

Figure 13 - (con't).



(e)
150-3, 10 MHz

(f)
No S/N, 10 MHz

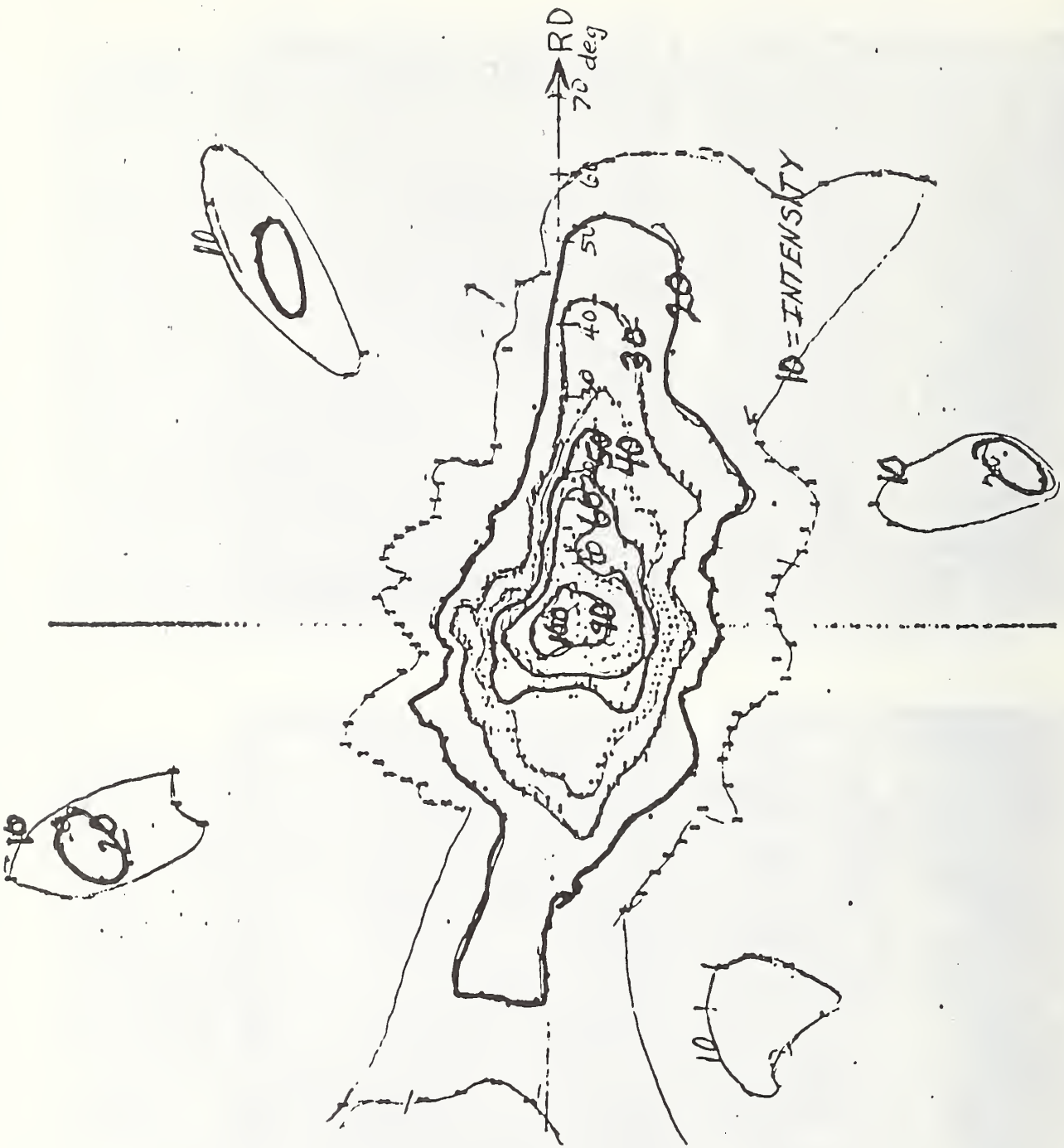

Figure 14 - (200) pole figure for 7075-T631 aluminum.



Figure 15 - (111) pole figure for 7075-T631 aluminum

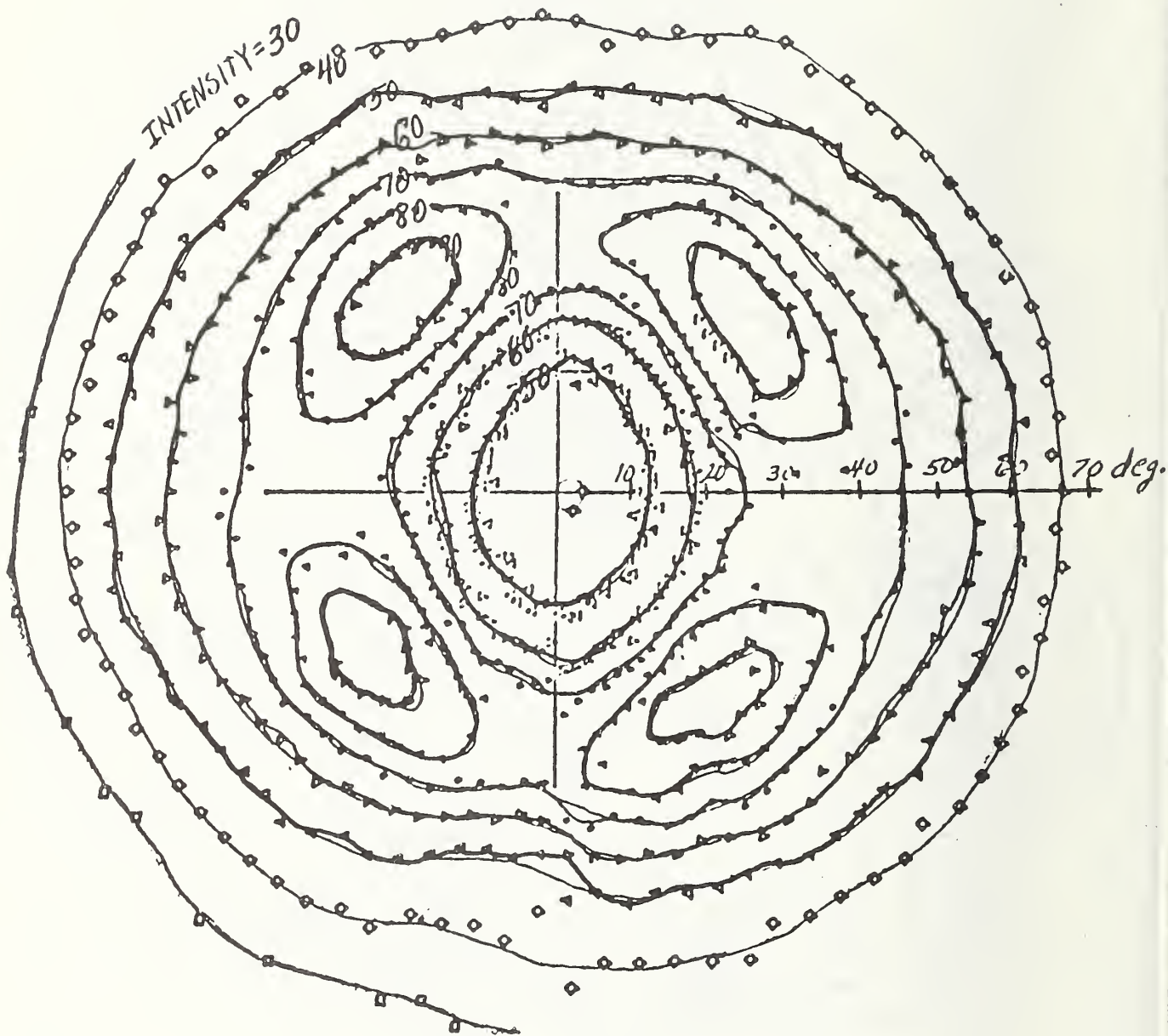

Figure 16 - (10.1) pole figure for commercial titanium sheet

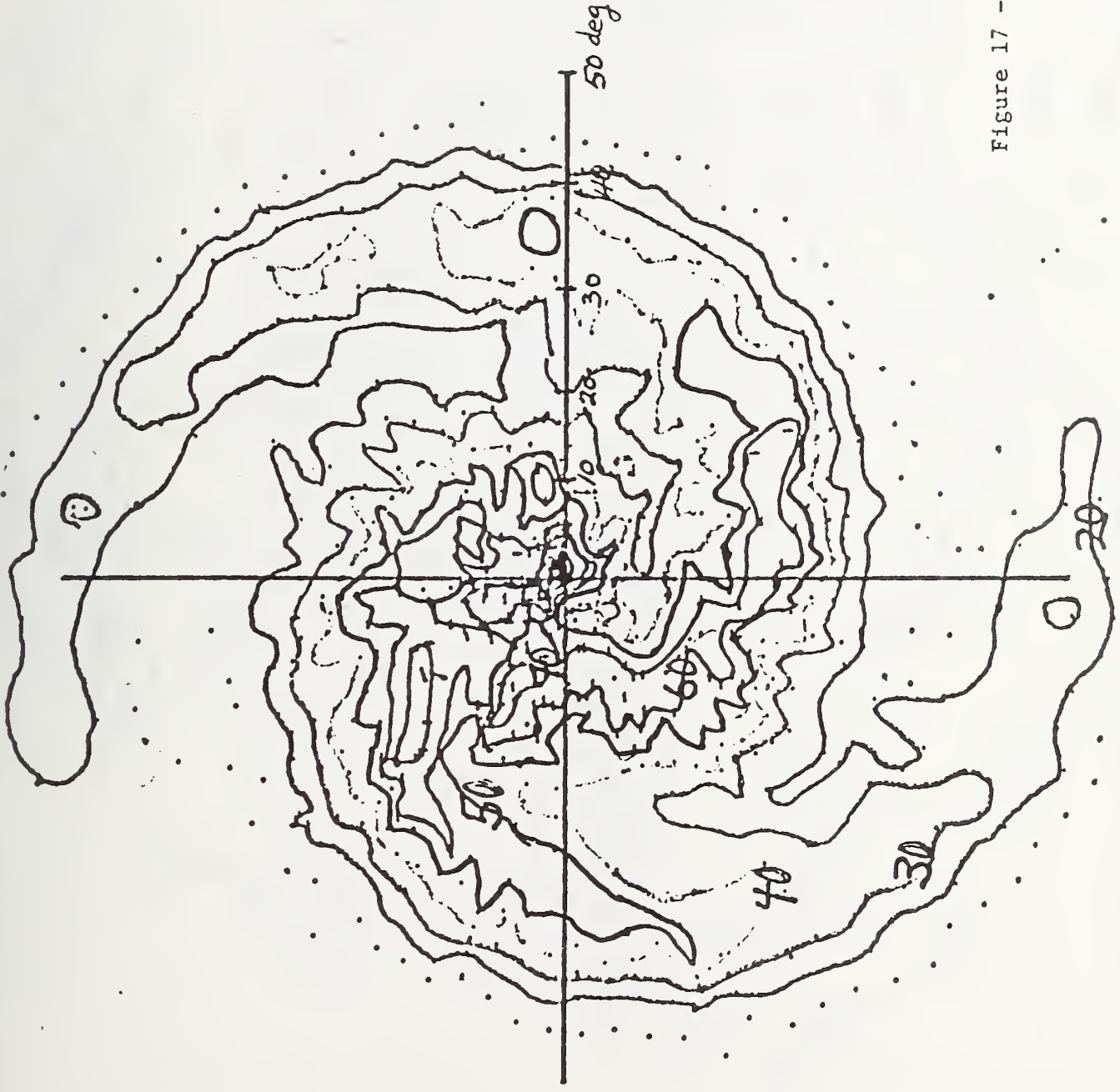

Figure 17 - (00.2) pole figure for annealed commercial titanium sheet.

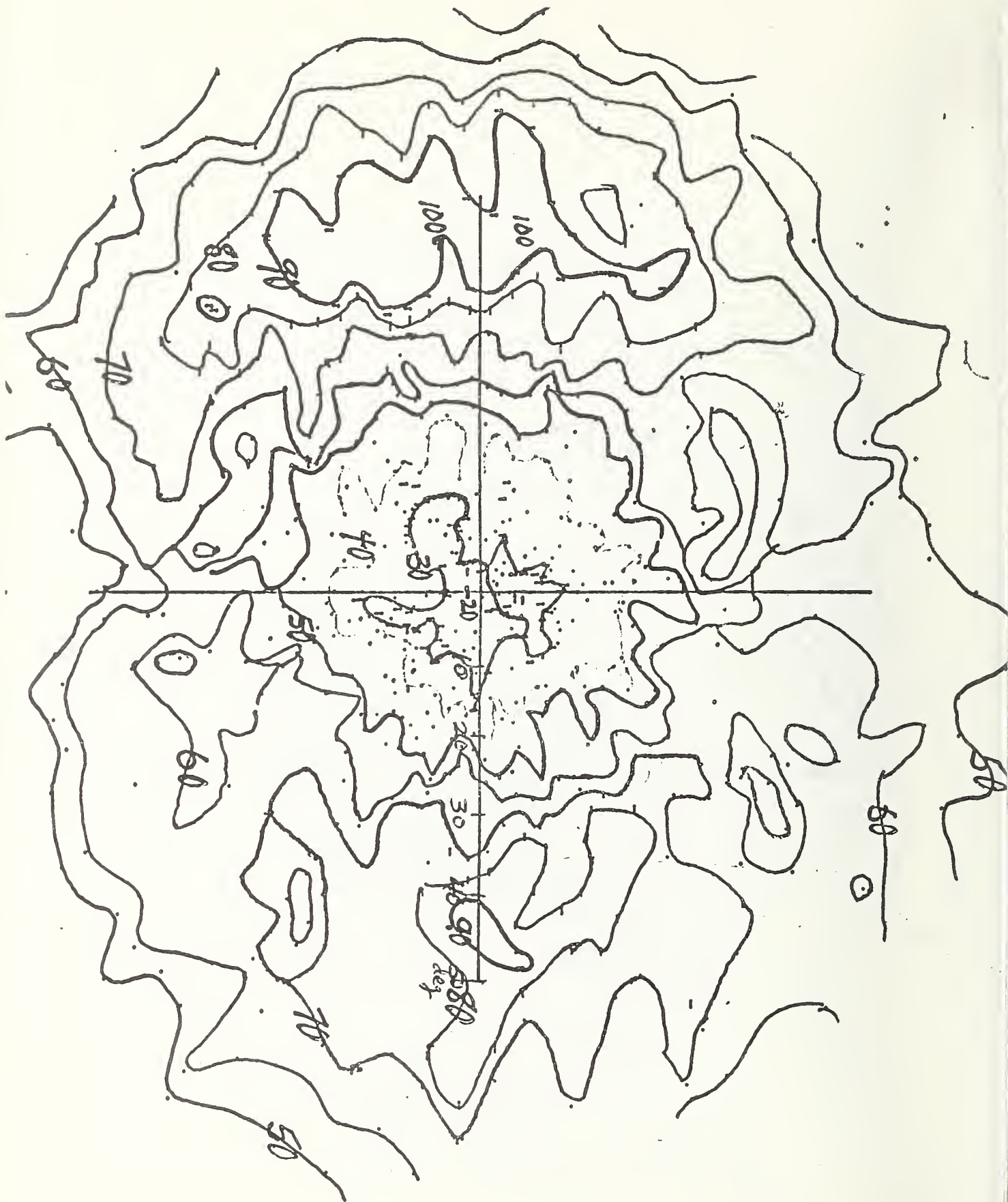

Figure 18 - (10.0) pole figure for annealed commercial titanium sheet.

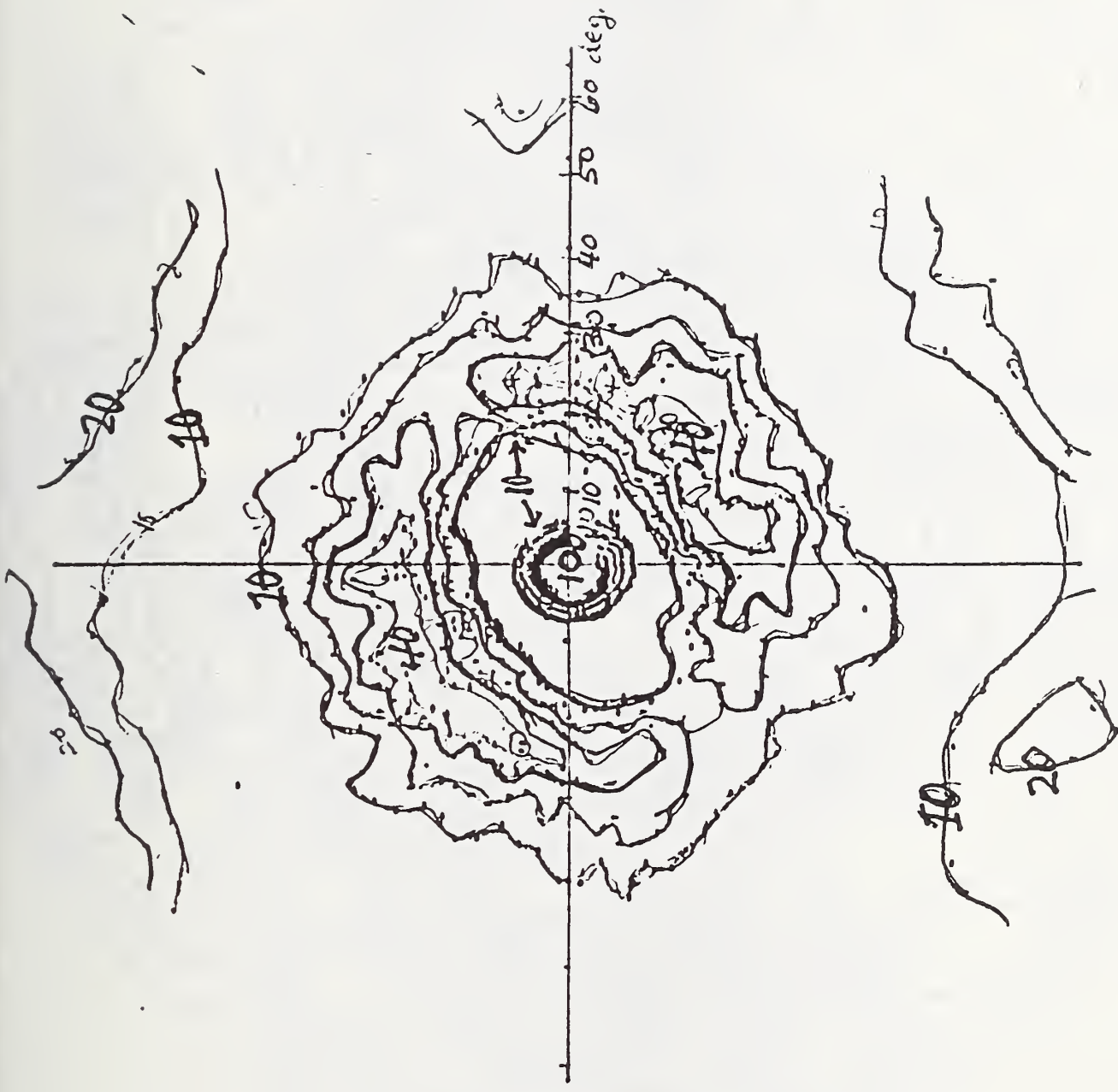

Figure 19 - (200) pole figure for slice from aluminum reference block.



Figure 20 - (111) pole figure for slice from aluminum reference block.

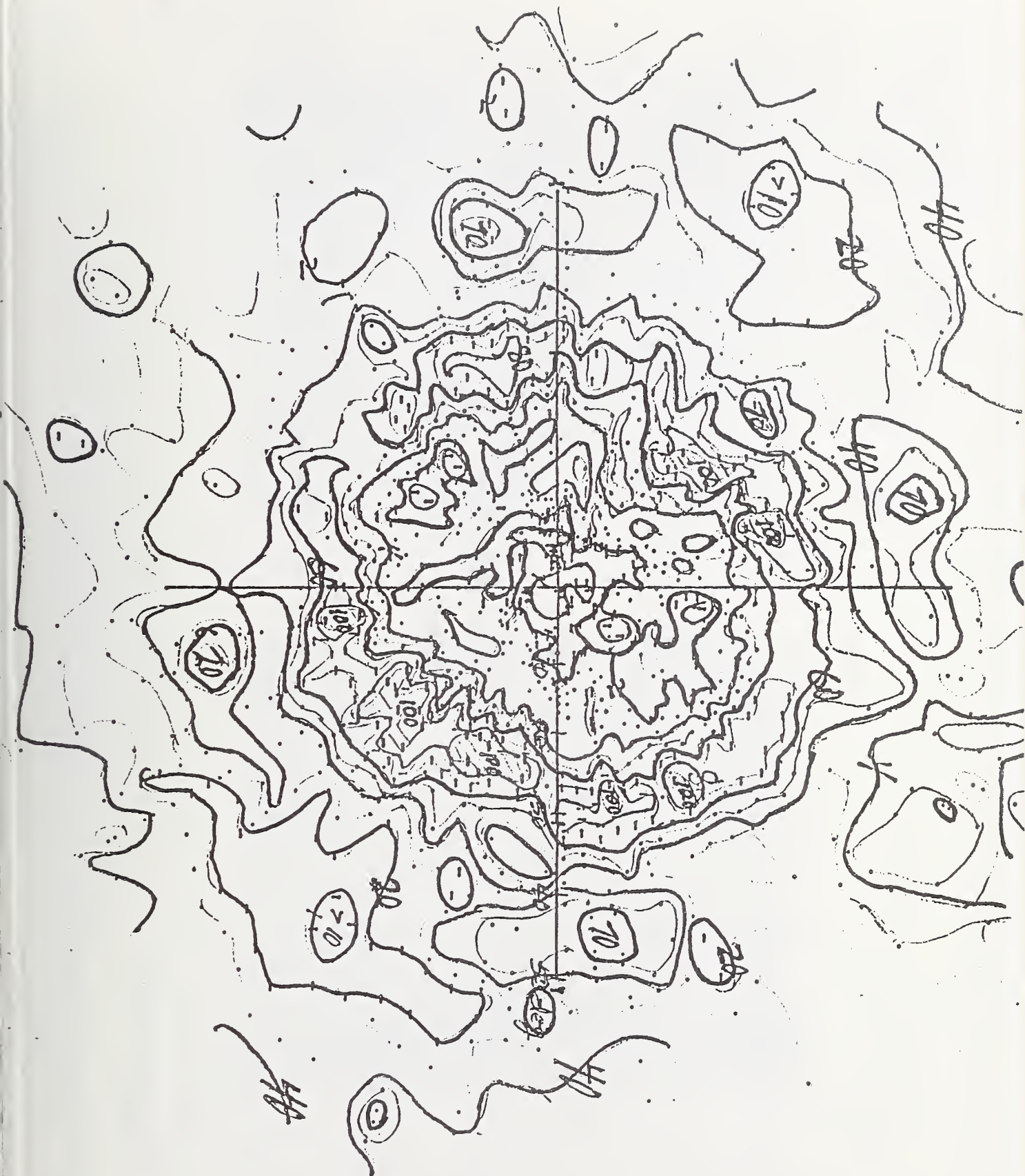

Figure 21 - (220) pole figure for slice from aluminum reference block.

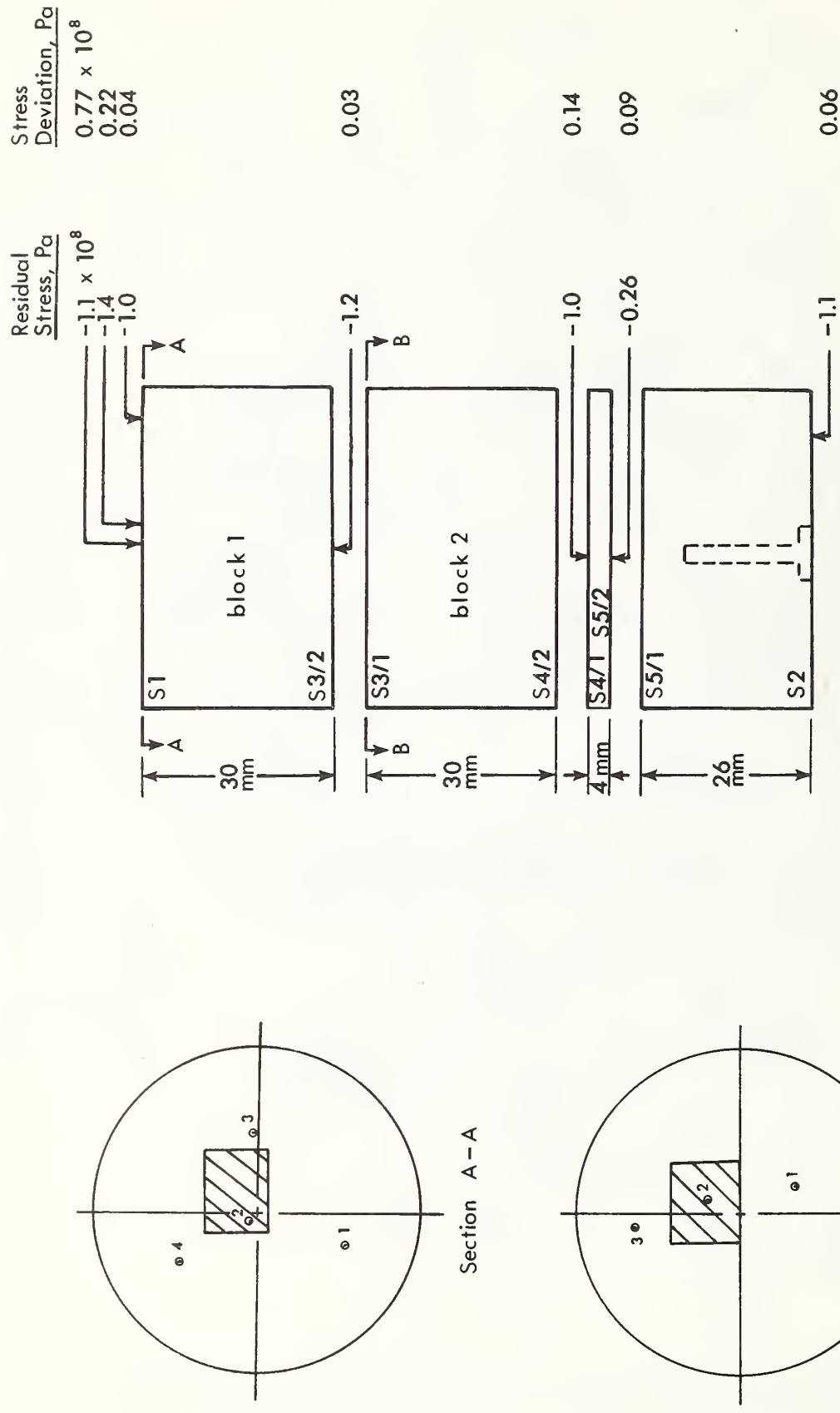

Figure 22—Ultrasonic and residual stress data on rejected aluminum reference block.
 Note 1 Pa = 1.45×10^{-4} lbf/in², 1 mm = 0.039 in.

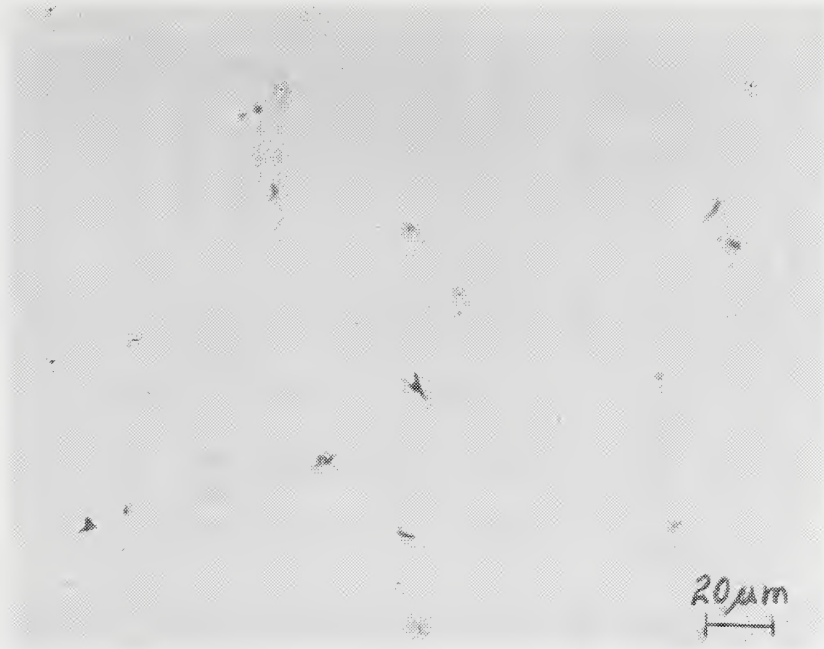

Figure 23 - Optical micrograph of surface S2 as polished.

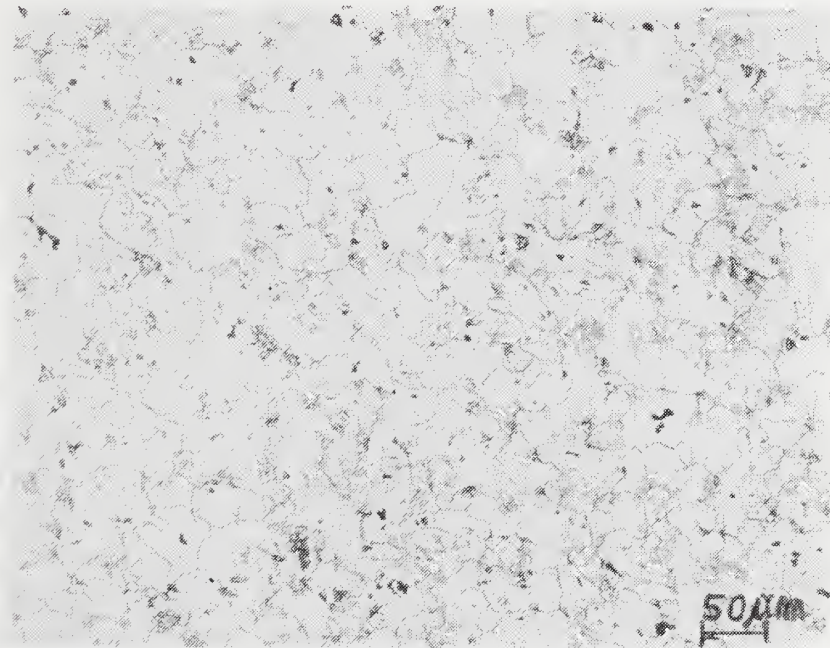

Figure 24 - Optical micrograph of surface S2 after first etching.

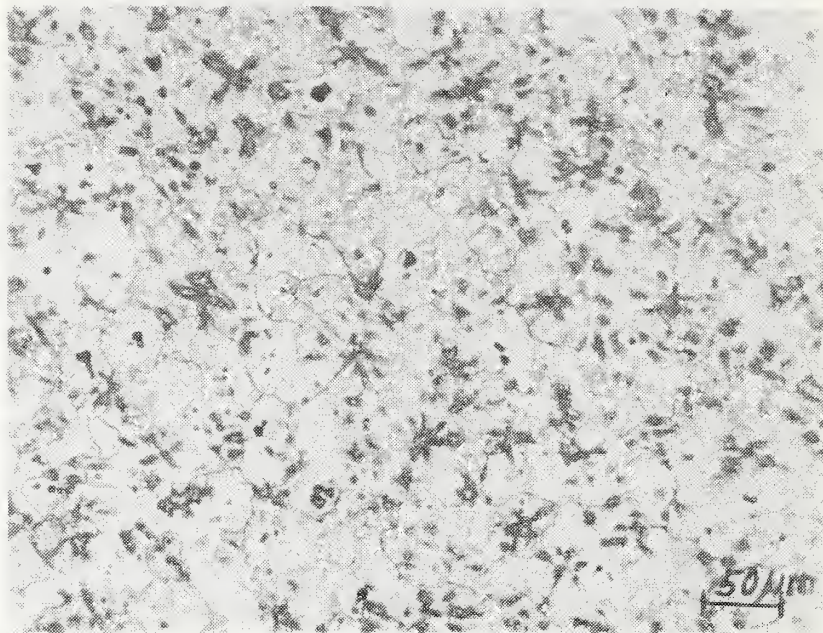

Figure 25 - Optical micrograph of surface S2 after longer etching.

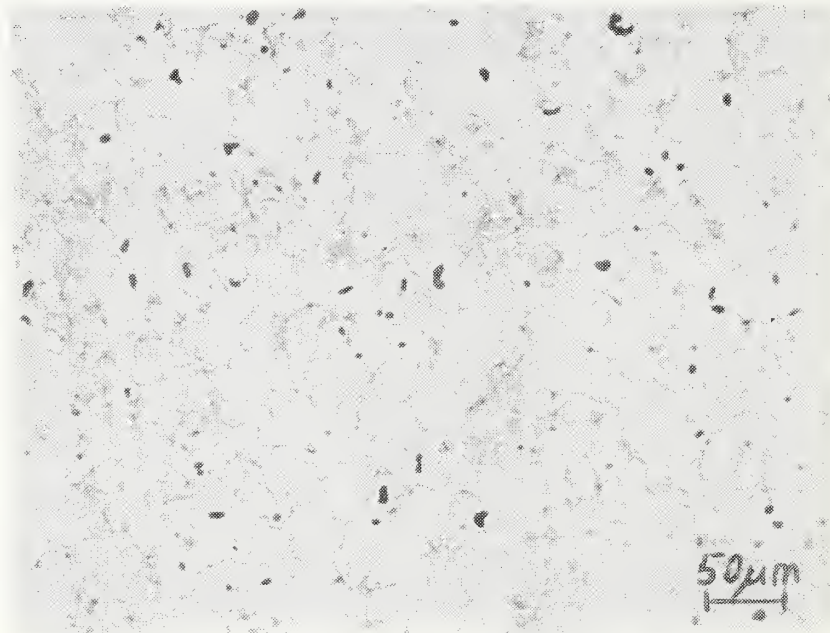

Figure 26 - Optical micrograph of surface S2 after repolishing.

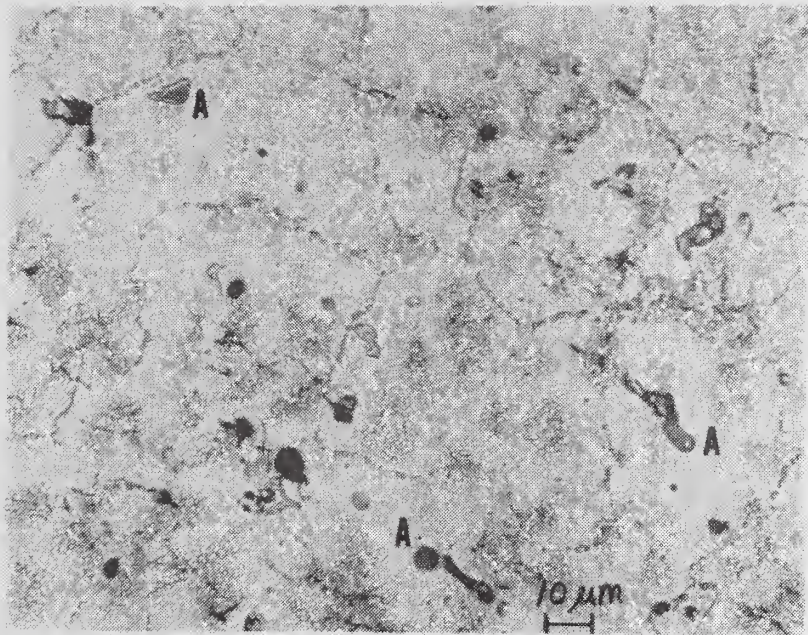
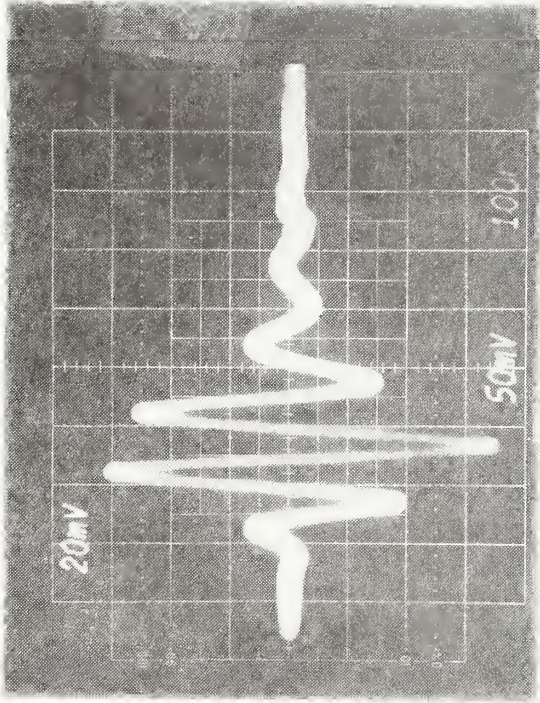
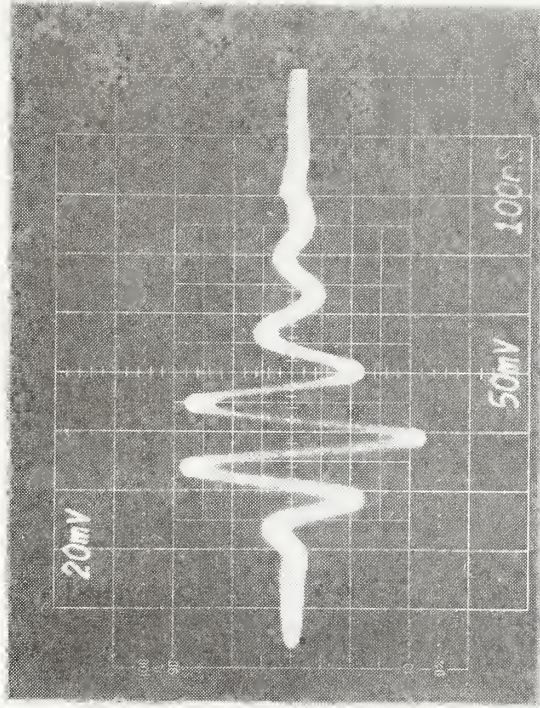

Figure 27 - Higher magnification optical micrograph of surface S2 after repolishing.



(a) point 1



(b) point 2

Figure 28 - Waveforms and spectra of back surface reflections of block 1.
See Table 3 and Figure 22.

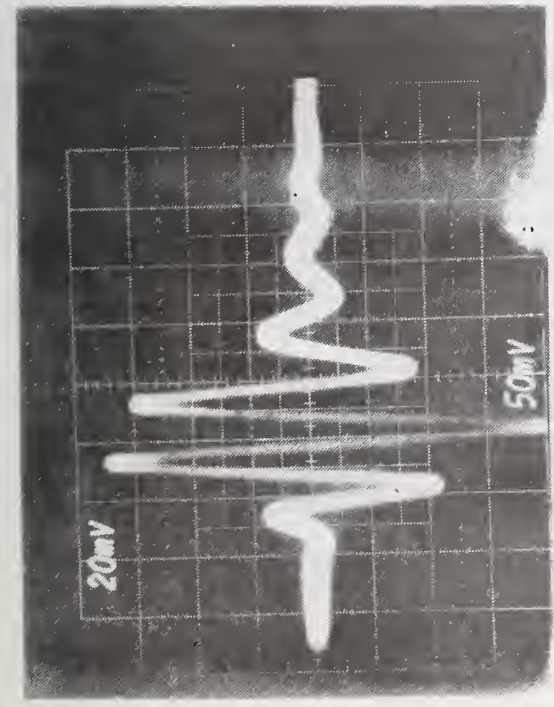

(c) point 3

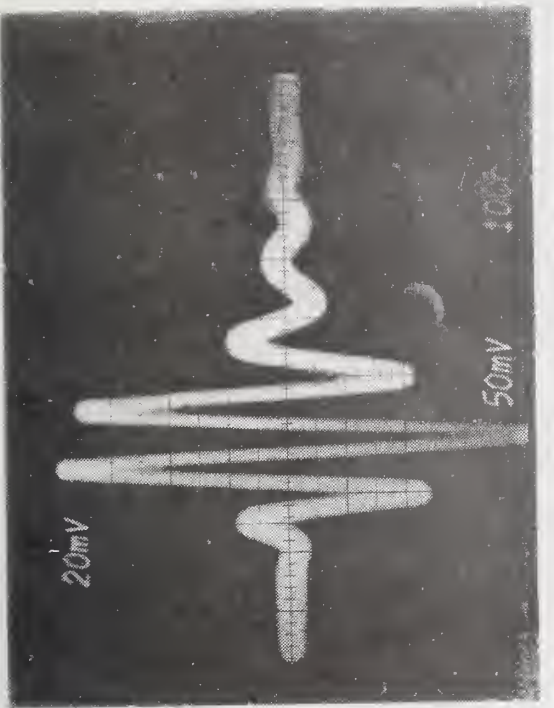

(d) point 4

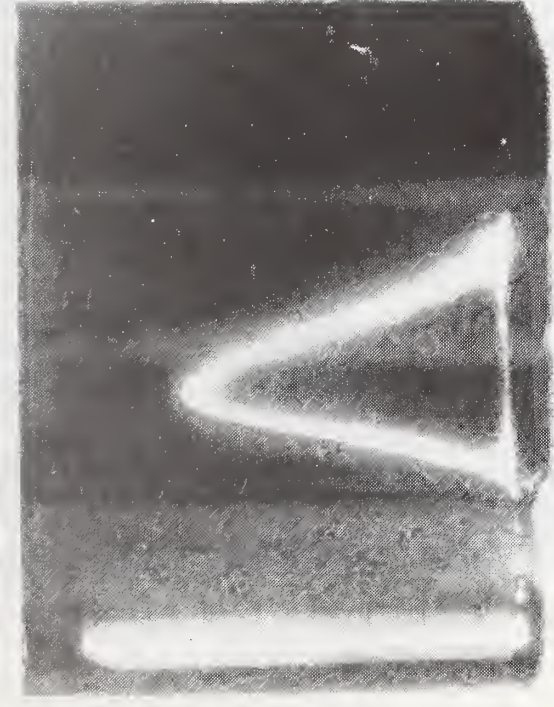
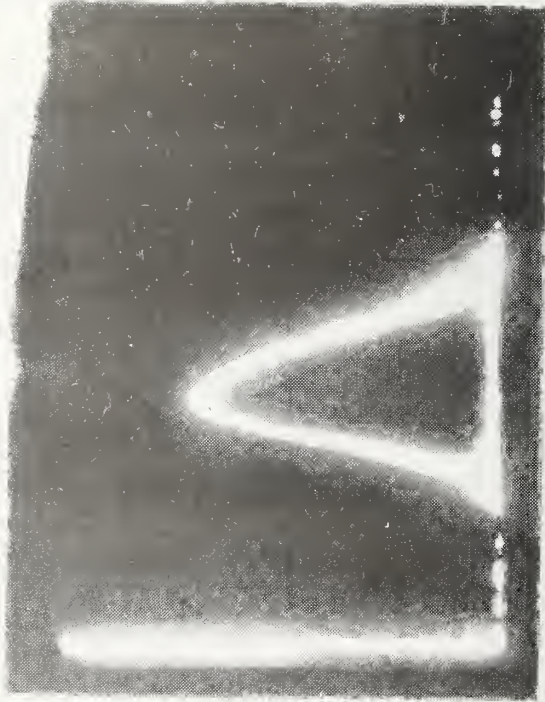
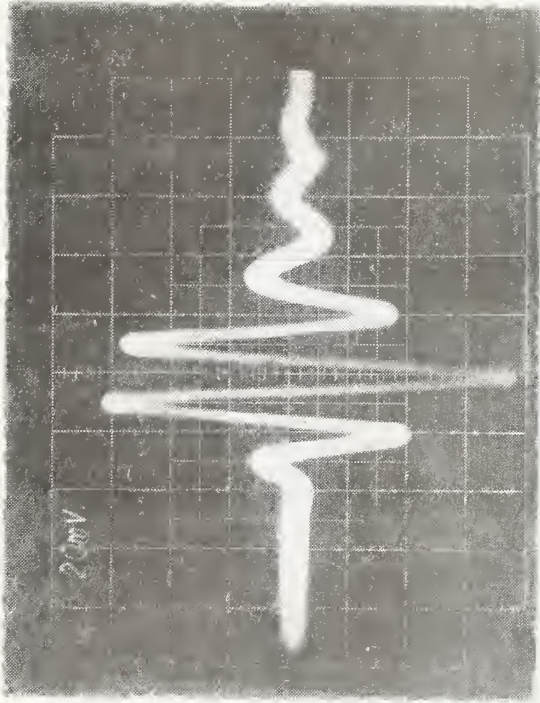
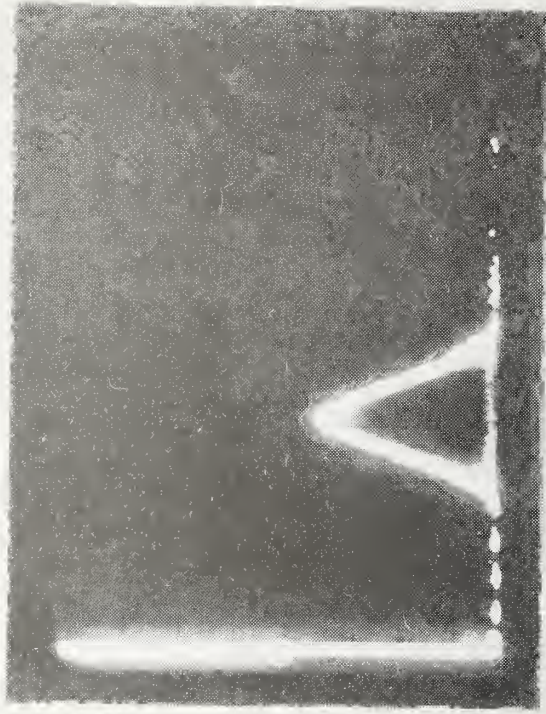
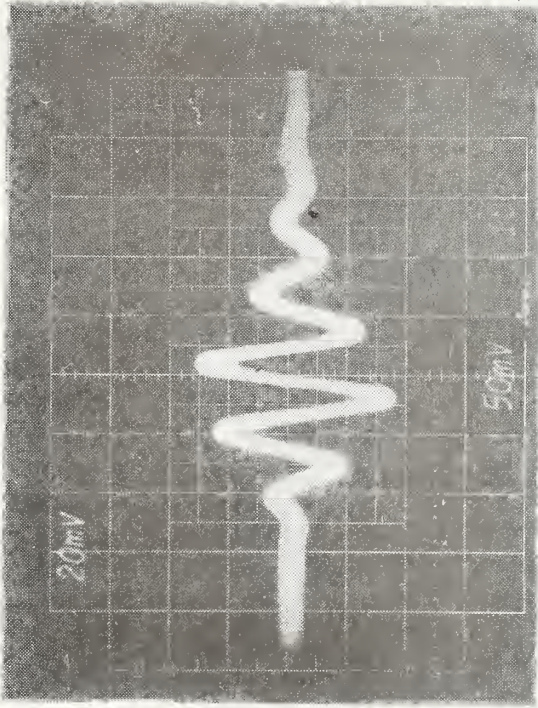

Figure 28 - (con't).



(a) point 1



(b) point 2

Figure 29 - Waveforms and spectra of back surface reflections of block 2.
See Table 3 and Figure 22.

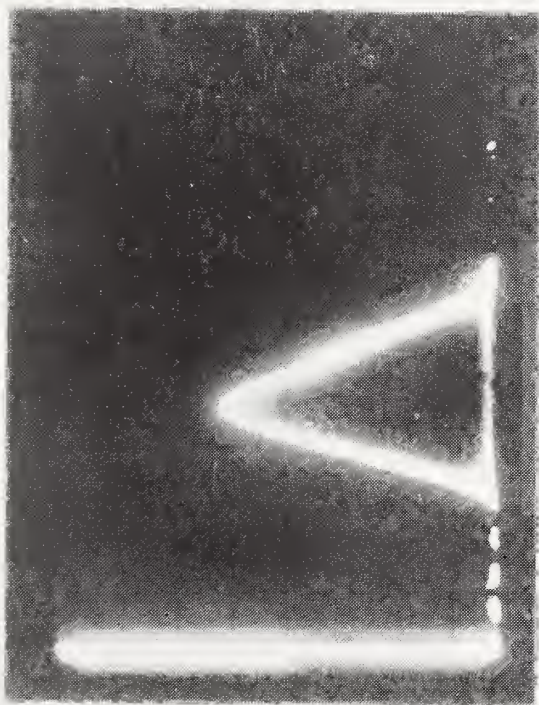
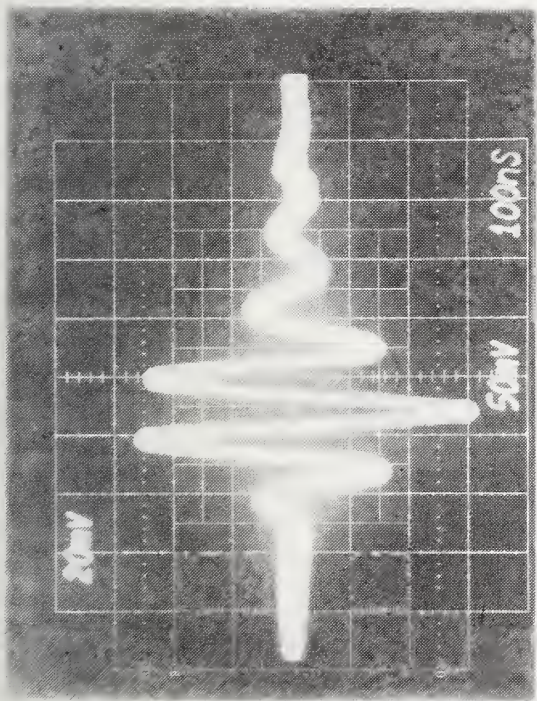

(c) point 3

Figure 29 - (con't).

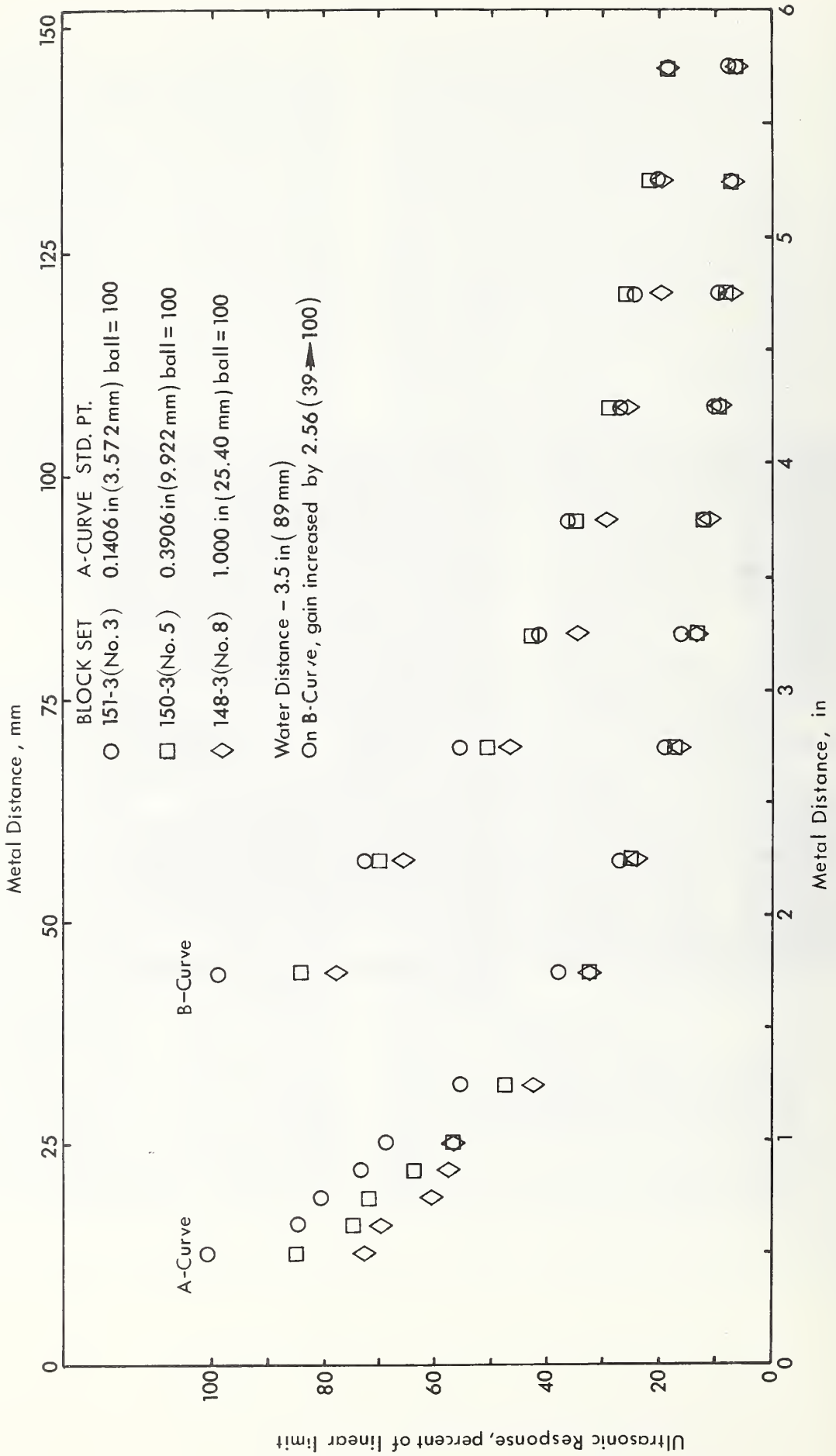

Figure 30- Universal distance-amplitude curves for three sets of aluminum reference blocks.

APPENDIX A

Equipment Specifications

Some of the important specifications for the equipment identified in Section 3.2 are given below:

1. Ultrasonic Immersion System

a) Tank Dimensions:

Length	38 in	97 cm
Width	21 in	53 cm
Depth	18 in	46 cm

b) Bridge and Carriage

Operating in the automatic scanning mode the bridge and carriage assembly is controllable within the following limits:

- (1) Bridge Indexing
 - adjustable from 0.001 in (0.03 mm) to 0.099 in (2.5 mm) in 0.001 in (0.03 mm) increments.
- (2) bridge travel
 - at least 38 in (97 cm)
- (3) carriage speed
 - continuously adjustable from approximately 0.5 in (1 cm) to 15 in (38 cm) per second.
- (4) carriage travel
 - adjustable from approximately 4.0 in (10.2 cm) to 12 in (30 cm) in 0.5 in (1 cm) increments.

c) Motorized Manipulator and Search Tube

- (1) vertical indexing
 - adjustable from 0.001 in (0.03 mm) to 0.099 in (2.5 mm) in 0.001 in (0.03 mm) increments.
- (2) vertical travel
 - at least 17.0 in (43 cm).

d) Auxiliary Manipulator

This mini-manipulator provides angular adjustment in two right angle vertical planes with tilt ranges of ± 30 degrees. Uncertainty in angular adjustments is less than 1 degree.

e) X-Y Recorder

The X-Y recorder is a dry paper type using electrosensitive paper with an electrostatic paper hold down. The pen is mechanically driven to provide approximately 1 to 1 recordings.

- platen size - 11 by 17 in (28 by 43 cm).

f) Temperature Control

An immersion heater with thermostatic control provides the capability of maintaining temperature in the 70 °F to 80 °F (21 °C to 27 °C) range with a time variation of 1 °F (.05 °C).

g) Water System

An internal water system consisting of a pump, filter, and water skimmer is provided.

2. Broadband Ultrasonic System

a) Pulser/Receiver

(1) Pulser

- output voltage selectively variable from 40 to 350 V into 50 ohms.
- rise time - 5 - 15 ns measured between 10 and 90 percent amplitude points.
- pulse width - 15 - 150 ns measured full width at half amplitude.
- frequency - 0 - 30 MHz.
- repetition rate - 500 to 5000 Hz internal oscillator; 0 to 10000 Hz external source.
- damping resistance - 5 to 500 ohms.

Typical pulses are shown in Figure A-1. These were taken at the narrowest pulse width setting with minimum damping. Figure A-1 represents the pulse used under normal operating procedures documented in this work.

(2) Receiver

- frequency range - 0 to 30 MHz
- input impedance - 500 ohms
- gain 10 to 70 dB
- voltage output - maximum 2.5 V peak-to-peak

b) Gate

- eliminates unwanted signals from a repetitive pulse train to isolate the desired wave packet without distorting the wave packet.
- delay range - 0.2 to 1000 μ s.
- width range - 0.2 to 100 μ s.

- switching transients - less than 10 mV (see Figure A-2 for measured transients).
- bandwidth - 0.2 to 50 MHz.

Several commercially available "stepless" gates were evaluated. The unit chosen represents the most versatile gate with the required specifications in gate delay, width and minimized switching transients. Switching transients of those evaluated typically ranged from less than 10 mV for the laboratory system to 50 mV using an inexpensive double balanced mixer.

c) Peak Detector

- converts the peak amplitude of ultrasonic pulses to a proportionate DC voltage in both the linear and logarithmic mode.
- input range - 0.01 to 1.0 V positive.
- input pulse width - 20 ns minimum.
- linearity - ± 5 percent of peak amplitude or ± 2 mV at input, whichever is greater.
- linear gain - adjustable from 0.5 to 16 times the input.
- logarithmic gain - adjustable from 40 to 1.25 dB full scale.
- DC offset - 0 to 5 V or 0 to 40 dB.
- output voltage - 0 to 1 VDC into 1000 ohms.
- decay time - 0.01, 0.1, and 1 seconds.

d) Quantizer

- enables a step-wise quantization of gated video signals into discrete DC voltages.
- input range - 0 to 10 V peak video signals.
- input pulse width - 200 ns minimum.
- quantization range - 5 to 80 increments into a total range of 40 dB.

3. Spectrum Analyzer

The spectrum analyzer consists of a storage CRT with separate IF and RF plug-in modules.

- frequency range - 0 to 110 MHz with adjustable center frequency.
- bandwidth - 0.01 to 300 kHz.
- scan width - 0.02 kHz to 10 MHz per division.
- scan time - 0.01 to 10 seconds per division.
- calibrated vertical reference level.
 - log +10 to -72 dBm per division.
 - linear 0.025 μ V to 100 mV per division.

4. Search Units

Search units purchased for this work are listed in Table A-1 by crystal diameter and nominal center frequency. Both immersion and contact types are included. These represent but a sample of the available size-frequency combinations. Particular emphasis has been placed on the 0.375 in (0.953 cm) quartz crystal at 5.0 and 15.0 MHz in order to be compatible with ASTM E 127 specifications of 1964 and proposed modifications, as well as search unit size and frequency combinations suitable for use in Task 3.

Table A-1 - Ultrasonic Search Units

Size in cm	Frequency (MHz)											
	2.25		5.0		10.0		15.0					
	Immersion	Contact	Immersion	Contact	Immersion	Contact	Immersion	Contact	Immersion	Contact	Immersion	Contact
0.25 0.63						4				1		1
0.375 0.953			6				1			5		
0.5 1.27	2	1	3	2		2	1			1		
0.75 1.9						1 (a)						

(a) Focused

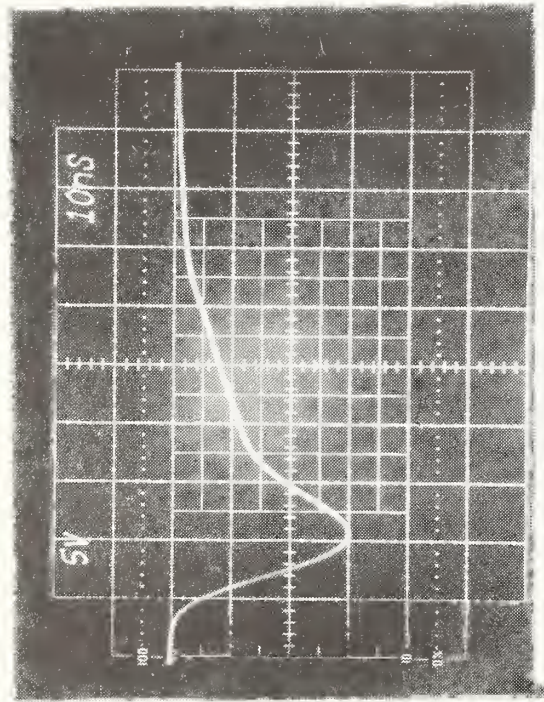

(a)

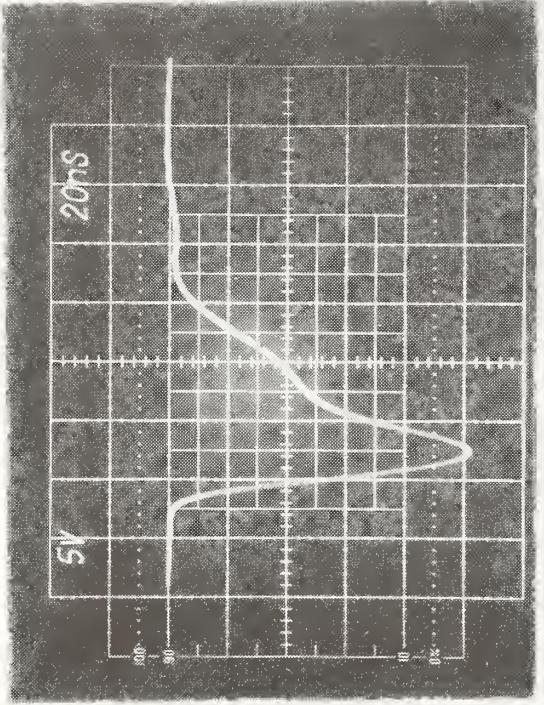

(b)

Figure A-1 - Typical pulse waveforms from laboratory pulser.

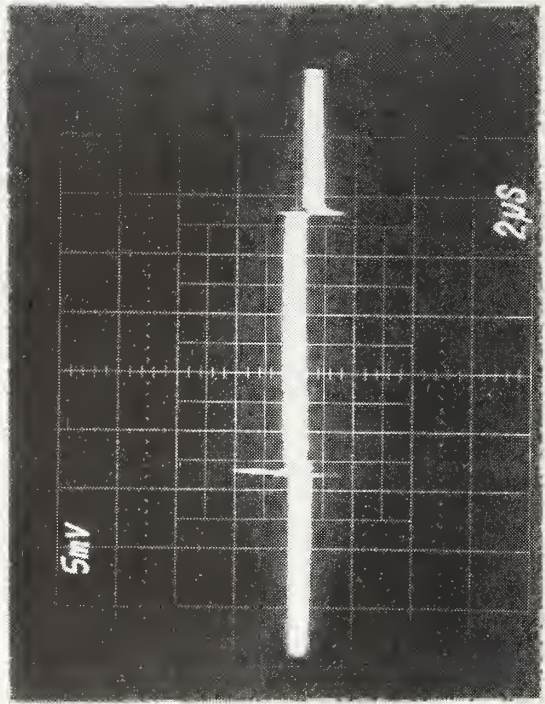

Figure A-2 - Typical "steps" (switching transients) in the gated output.

APPENDIX B

Organizations offering Loan of Reference Blocks

Aluminum Company of America
Battelle Memorial Institute
CBL Industries, Inc.
Curtiss-Wright Corporation
Kaiser Aluminum Company
Krautkramer-Branson, Inc.
LTV Aerospace Corporation
Met Lab Inc.
NASA, Lewis Research Center
Naval Research Labs
Naval Weapons Center
Pratt and Whitney Aircraft Company
Reynolds Metals Company
Westinghouse Electric Corporation
Wyman-Gordon Company



POLEFT Program

```
420 A(M)=0
430 B(M)=0
440 FORN=1 TO E9*2
450 A(M)=A(M)+C(N)*SIN(P*M*C)
460 B(M)=B(M)+C(N)*COS(P*M*C)
470 C=C+M6
480 NEXTN
490 A(M)=A(M)/E9
500 B(M)=B(M)/E9
510 NEXTM ' FOURIER END.
520 B0=1000
530 B9=0
540 C=M6/2
550 S8=0
560 FORN=X9 TO E9*X9 ' CALCULATES POINTS BETWEEN OBSERVED POINTS;
570 D(N)=B(0)/2
580 FORM=1 TO X9
590 D(N)=D(N)+A(M)*SIN(C*P*M)+B(M)*COS(C*P*M)
600 NEXT M
610 C=C+M6/X9
620 IF B9>D(N) THEN 650 ' FIND POSITION OF CROSS-OVER POINTS.
630 B9=D(N)
640 B3=N
650 IF B0<D(N) THEN 680
660 B4=N
670 B0=D(N)
680 NEXTN
690 W4=0
700 C=D(X9)
710 FORN=X9+1 TO E9*X9
720 C1=D(N)
730 FORM=INT((B0+9.999)/10)*10 TO B9 STEP 10
740 IFC=M THEN 820
750 IFC>M THEN 780
760 IFC1<=M THEN 830
770 GOTO 820
780 IFC1>=M THEN 800
790 GOTO 820
800 NEXTM
810 GOTO 830
820 GOSUB 1110
```

POLEFT Program

```
830 C=C1
840 NEXTN
850 FORN1=2TCW4 ' ROUTINE FOR ELIMINATING UNWANTED POINTS.
860 IF I(N1-1)<>I(N1)THEN890
870 NEXTN1
880 GOTO1050
890 N5=N1-1
900 GOSUB 1210
910 N5=N1
920 GOSUB1210
930 N4=0
940 FORN2=N1+1TCW4
950 IF I(N2-1)<>I(N2)THEN980
960 N4=N4+1
970 GOTO1040
980 IF N4=0 THEN 1010
990 N5=N2-1
1000 GOSUB 1210
1010 N5=N2
1020 GOSUB1210
1030 N4=0
1040 NEXTN2
1050 NEXTM1
1060 FORN=1TC9 ' PRINTS OUT NO. OF POINTS AT EACH LEVEL.
1070 PRINTN;Q(N);
1080 NEXTN
1090 PRINT
1100 GOTO 70
1110 W4=W4+1 'ROUTINE TO FIND POLAR AND CARTESIAN COORDINATES.
1120 A=((N-1-X9)*5/X9+M1*A1)
1130 B=F*M1-B1
1140 D=10*TAN(P*A/2)
1150 X=D*COS(P*B)
1160 Y=D*SIN(P*B)
1170 X(W4)=X
1180 Z(W4)=Y
1190 I(W4)=M
1200 RETURN
1210 OUTPUT#2,I(N5);X(N5);Z(N5); 'OUTPUT TO FILE FOR PLOTTER.
1220 Q(I(N5)/10)=Q(I(N5)/10)+1 ' CCUNTS NO OF POINTS AT EACH LEVEL.
1230 RETURN
1240 END
```



POLEPL Program

```

10  ' POLEPL PLOTS POINTS ON A POLE FIGURE FROM DATA STORED IN A
20  ' FILE CREATED BY PCLEFT.
30  DATA4999,2000,4999,8000,2000,4999,8000,4999,9999,9999
40  PRINT"          PLTL"
50  FORM9=1TC5  ' FORMS CENTER LINE FOR POLE FIGURE.
60  READA1,B1
70  IFM9/2=INT(M9/2)THEN100
80  PRINTUSING950,A1,B1
90  GOTO110
100 PRINTUSING1000,A1,B1
110 NEXTM9
120  PRINT"          PLTT"
130 PRINT"ENTER NAME OF INPUT FILE";
140 INPUTA$  ' PERMITS DESIGNATION OF FILE AT RUN TIME CREATED
150 FILESA$  ' BY PCLEFT.
160 REM:INTENSITYPLOTS
170 DIMC(11,3),P(11),CS(10)
180 LO=2.302585093
190 P1=3.141592654
200 U7=0
210 W6=H6=4999.5
220 MATREADC(11,3)  ' READS DATA FOR SYMBOLS AVAILABE FOR PLOTTING.
230 DATA-270,-90,180,-180,0,180,-270,-90,180,-180,0,180
240 DATA-270,90,120,-90,270,120,-270,90,90,-225,135,90,-270,90,30
250 DATA-240,120,120,-180,180,120
260 MATREADP(11)  ' READ DATA TO DETERMINE SIZE OF SYMBOLS.
270 DATA2.5,2.5,2,2,1.5,1.5,1.42,1.42,2,1.5,1.5
280  R3=7.5
290  R6=.075
300  W7=H7=4999.5/R3
310  PRINT"MAXIMUM RADIUS="50/R3,"POINT SIZE="50/R6
320  W1=10*(INT(LOG(R3)/LO))
330  R4=INT(.5+R3/W1)
340  FORJ=0TC2
350  IFR4<=(1+J*J)THEN370
360  NEXTJ
370  W1=W1*(1+J*J)/10
380  R3=W1*INT(.5+R3/W1)
390  U9=2
400  H8=0
410  U7=0
420  FORM9=90TC10STEP-10
430  PRINT"ENTER COLOR AND SYMBOL NO.";
440  INPUT A$,J6  'PERMIT SELECTION OF COLOR & SYMBOL FOR EACH
450  PRINTA$;J6;M9  'INTENSITY AT RUN TIME.
460  IFJ6=0THEN480
470  R5=R6/P(J6)
480  N=U8=0
490  RESTORE#1
500  IFEND#1THEN770
510  INPUT#1,I9,X7,Y7
520  IFI9<>M9THEN500  ' SEARCHES FILE FOR DATA WITH CERTAIN
530  N=N+1  ' INTENSITY VALUES. IF PASSES TEST IN 510

```

POLEPL Program

```
540 IFJ6<>OTHEN660          ' DATA PREPARED FOR PLOTTING IN SUBPLT RCUT.
550 U9=1
560 W8=X7
570 H8=Y7
580 GOSUB860
590 IFU8=OTHEN500
600 U8=0
610 IFU7=OTHEN640
620 U7=0
630 PRINT "          PLTT"
640 PRINT "PCINT OFF SCALE. X =";X7;" Y =";Y7;" INTENSITY =";I9
650 GOTO500
660 U9=2
670 FORC9=C(J6,1)TCC(J6,2)STEP C(J6,3)
680 C8=C9*P1/180
690 W8=X7+R5*CCS(C8)
700 H8=Y7+R5*SIN(C8)
710 IFJ6>2THEN730
720 U9=1
730 GOSUB860
740 IFU8=1THEN600
750 NEXTC9
760 GOTO500
770 W8=H8=R3
780 U9=1
790 GOSUB860
800 PRINT "          PLTT"
810 U7=0
820 IFN>OTHEN840
830 PRINT "
      NO POINTS FOUND WITH";I6;" <= INTENSITY <="";I7
840 NEXTM9
850 STOP
860 REM: SUBROUTINE 'SUBPLT' FOR PLOTTING
870 W9=INT(W6+W7*W8)
880 H9=INT(H6+H7*H8)
890 IFW9>9999CRW9<0CRH9>9999CRH9<0THEN1020
900 IFU7<>OTHEN930
910 U7=1
920 PRINT"PLTL"
930 IFU9=OTHEN990
940 PRINTUSING950,W9,H9
950 :#### ####
960 IFU9=1THEN1030
970 U9=0
980 GOTO1030
990 PRINTUSING1000,W9,H9
1000 :#### ####
1010 GOTO1030
1020 U8=1
1030 RETURN
```

APPENDIX E

STRESS Program

```

5 'PROGRAM FOR CALCULATING STRESS
10 :###.# ### ###.### ###.###
15 T9=.085959596
20 T8=.91782/T9
25 PRINT"ENTER NAME OF INPUT FILE";
30 INPUT$ 'PERMITS DESIGNATION OF FILE AT RUN TIME.
35 IF$="STOP"THEN840
40 DIMC$(72),D$(72)
45 FILES$
50 INPUT#1,C$,D$
55 REMC$,D$
60 P9=&PI/180
65 Z9=0
70 M=0
75 INPUT#1,A1,S9 'READS STARTING ANGLE & ANGLE OF INCLINATION.
80 X(1)=T9/2
85 FORI=1TO10000 'START OF DATA READING ROUTINE.
90 INPUT#1,Y
95 IFEND#1THEN135
100 IFY<0THEN135 'DETECTS FLAG IN FILE.
105 S3=S9*P9
110 Z=P9*(A1+X(I))
115 Y(I)=Y/((1-TAN(S3)*COT(Z/2))*(1+COS(Z)^2)/(2*SIN(Z/2)^2))
120 M=M+1 'ABOVE CALCULATES LP & PSI CORRECTIONS--SEE SAE 78-182
125 X(I+1)=X(I)+T9
130 NEXTI
135 FORI=1TCM
140 Y(2*M+1-I)=Y(I)
145 NEXTI
150 M=2*M
155 DIMP(300),Q(300),A(300),B(300),C(300),D(300),X(300),I(600),Y(300)
160 P=2*&PI
165 FORN=0TCM/4 'ROUTINE FOR CALC. FOURIER COEF. SEE GANGULEE
170 P(N)=1+.47*CCS(P*N*T8/M)
175 Q(N)=.47*SIN(P*N*T8/M)
180 M1=A=B=0
185 FORX=1TCM
190 X1=X-.5
195 A=A+Y(X)*CCS(P*N*X1/M)
200 B=B+Y(X)*SIN(P*N*X1/M)
205 NEXTX
210 A(N)=A/M*2
215 B(N)=B/M*2

```

STRESS Program

```
455 F1=W/W1
460 W1=W
465 GOTO370
470 U(2)=U(2)-E2*U(3)
475 Z9=Z9+1
480 A2=-U(2)/(2*U(3))- .5
485 A3=A2=T9/4+A1 'FINDS TWC-THETA ANGLE.
490 H(Z9)=S9
495 Z(Z9)=A3
500 PRINTUSING10,A2;S9,A3
505 PRINT"
```

..

```
510 IFY<-100THEN520
515 GOTO70
520 :YOUNG'S MODULUS = #.#!!!! N/M^2; #.#!!!! KG/MM^2; #.##!!!! PD/IN^2
525 :POISSON'S RATIO =#.#
530 :STRESS COMPONENT=-#.#!!!! N/M^2; -#.#!!!! KG/MM^2; -#.#!!!! PD/IN^2
535 :   ###      ###.###      #.###      -#.###      -#.###
540 :PROBABLE ERROR OF LINEAR FIT   =-#.###
545 :RELATIVE STAND. DEV. OF STRESS =###.# PER CENT
550 :ERROR RELATIVE TO AV. CRDINATE =###.# PER CENT
555 :STANDARD DEVIATION OF STRESS   =-#.#!!!! N/M^2
560 PRINT"
```

..

```
565 C=D=E=F=S1=W=0
570 N=.33 'POISSON RATIO
575 E1=10400000 'YOUNG'S MODULUS FOR 7075 AL. ALLOY.
580 E1=6894.75*E1
585 PRINTC$
590 PRINT
595 PRINT
600 FORI=1TOZ9 'START OF STRESS ROUTINE.
605 S3=P9*H(I)
610 Y(I)=Z(I)-Z(1)
615 X(I)=SIN(S3)*SIN(S3)
620 C=C+Y(I)
```

STRESS Program

```
220 NEXTN
225 A(0)=A(0)/2
230 FORN=0TCM/4 'ROUTINE FOR FINDING ALPHA1 FOURIER CCEF.
235 E=P(N)*P(N)+Q(N)*Q(N)
240 C(N)=(A(N)*P(N)+Q(N)*B(N))/E
245 D(N)=(-A(N)*Q(N)+B(N)*P(N))/E
250 NEXTN
255 A3=0
260 FORX=2TCM*2
265 X1=X-.5
270 I=0
275 FORN=0TCM/4 'CALCULATES ALPHA1 PEAK.
280 I=I+C(N)*COS(P*N*X1/(M*4))+D(N)*SIN(P*N*X1/(M*4))
285 NEXTN
290 I(X)=I
295 IFA3>ITHEN310 'FIND HIGHEST PCINT IN ALPHA1 PEAK.
300 A3=I
305 A2=X
310 NEXTX
315 T7=T9/4*(A2-.5)+A1
320 PRINTUSING10,A2,S9,T7,T7+T8*T9
325 M=60
330 FORI=1TCM 'START OF PARABCLA FITTING ROUTINE
335 Y(I)=I(A2-31+I)
340 X(I)=A2-31+I
345 P(I)=0
350 Q(I)=1
355 NEXTI
360 I=E2=F1=0
365 W1=M
370 W=E1=0
375 I=I+1
380 FORL=1TCM
385 W=W+Y(L)*Q(L)
390 E1=E1+X(L)*Q(L)*Q(L)
395 NEXTL
400 U(I)=W/W1
405 IFI-3>=0THEN470
410 E1=E1/W1
415 E2=E2+E1
420 W=0
425 FORL=1TCM
430 V=(X(L)-E1)*Q(L)-F1*P(L)
435 P(L)=Q(L)
440 Q(L)=V
445 W=W+V*V
450 NEXTL
```

STRESS Program

```
665 D=D+X(I)2
630 E=E+X(I)*Y(I)
635 F=F+X(I)
640 NEXT I
645 D5=D*Z9-F*F
650 Q1=(Z9*E-C*F)/D5
655 Q2=(C*D-E*F)/D5
660 PRINT USING 520, E1, E1/9806650, E1/6894.75
665 PRINT
670 PRINT USING 525, N
675 PRINT
680 S=-P9*Q1*E1/(2*(1+N)*TAN(.5*P9*Z(I)))
685 PRINT USING 530, S, S/9806650, S/6894.75
690 PRINT
695 IFS<0 THEN 710
700 PRINT "THIS IS A TENSILE STRESS IN THE PLANE OF THE SURFACE."
705 GOTO 715
710 PRINT "THIS IS A COMPRESSIVE STRESS IN THE PLANE OF THE SURFACE."
715 PRINT
720 PRINT
725 PRINT "DELTA 2*THETA FITTED TO LSE STRAIGHT LINE:"
730 PRINT " DEL 2TH = (";Q1;")*(SIN PSI)2 + (";Q2;")"
735 PRINT
740 PRINT " ANGLE OF"
745 PRINT "INCLINATION      2 THETA      SIN2      DEL 2TH      LSE FIT"
750 FCRI=1TCZ9
755 Z=Q1*X(I)+Q2
760 PRINT USING 535, H(I), Z(I), X(I), Y(I), Z
765 S1=S1+(Y(I)-Z)2
770 NEXT I
775 PRINT
780 S2=.6754*SQR(S1/(Z9-2))
785 PRINT USING 540, S2
790 C=C/Z9
795 PRINT USING 550, ABS(100*S2/C)
800 PRINT
805 PRINT
810 S3=SQR(S1*M/(D5*(M-2)))
815 S4=ABS(S3*S/Q1)
820 PRINT USING 555, S4
825 PRINT USING 545, ABS(100*S4/S)
830 PRINT"

835 GOTO 25
840 END
```

RESIDUAL STRESS ANALYSIS

AL BLOCK #1, BOTTOM SIDE

SURFACE S3/2

YOUNG'S MODULUS = $7.2E+10$ N/M²; $7.3E+03$ KG/MM²; $1.04E+07$ PD/IN²

POISSON'S RATIO = .33

STRESS COMPONENT = $-1.2E+08$ N/M²; $-1.2E+01$ KG/MM²; $-1.7E+04$ PD/IN²

THIS IS A COMPRESSIVE STRESS IN THE PLANE OF THE SURFACE.

DELTA 2*THETA FITTED TO LSE STRAIGHT LINE:

$$\text{DEL 2TH} = (1.16305) * (\text{SIN PSI})^2 + (.122302)$$

ANGLE OF INCLINATION	2 THETA	SIN ²	DEL 2TH	LSE FIT
0	155.305	.000	.000	.122
15	155.522	.067	.217	.200
30	155.781	.250	.476	.413
45	156.204	.500	.899	.704
60	156.147	.750	.842	.995

PROBABLE ERROR OF LINEAR FIT = .111

ERROR RELATIVE TO AV. COORDINATE = 22.7 PER CENT

STANDARD DEVIATION OF STRESS = $2.7E+07$ N/M²

RELATIVE STAND. DEV. OF STRESS = 22.6 PER CENT

RESIDUAL STRESS ANALYSIS

AL BLOCK #1, TOP SIDE CENTER

SURFACE S1

YOUNG'S MODULUS = $7.2E+10$ N/M²; $7.3E+03$ KG/MM²; $1.04E+07$ PD/IN²

POISSON'S RATIO = .33

STRESS COMPONENT = $-1.1E+08$ N/M²; $-1.2E+01$ KG/MM²; $-1.6E+04$ PD/IN²

THIS IS A COMPRESSIVE STRESS IN THE PLANE OF THE SURFACE.

DELTA 2*THETA FITTED TO LSE STRAIGHT LINE:

$$\text{DEL 2TH} = (1.09988) * (\text{SIN PSI})^2 + (5.90986E-2)$$

ANGLE OF INCLINATION	2 THETA	SIN ²	DEL 2TH	LSE FIT
0	155.228	.000	.000	.059
15	155.410	.067	.182	.133
30	155.585	.250	.357	.334
45	155.834	.500	.606	.609
60	156.102	.750	.874	.884

PROBABLE ERROR OF LINEAR FIT = .032

ERROR RELATIVE TO AV. ORDINATE = 7.8 PER CENT

STANDARD DEVIATION OF STRESS = $7.7E+06$ N/M²

RELATIVE STAND. DEV. OF STRESS = 6.8 PER CENT

RESIDUAL STRESS ANALYSIS

AL BLOCK, TOP, POLISHED NOT ETCHED

SURFACE S1

YOUNG'S MODULUS = $7.2E+10$ N/M²; $7.3E+03$ KG/MM²; $1.04E+07$ PD/IN²

POISSON'S RATIO = .33

STRESS COMPONENT = $-1.4E+08$ N/M²; $-1.4E+01$ KG/MM²; $-2.0E+04$ PD/IN²

THIS IS A COMPRESSIVE STRESS IN THE PLANE OF THE SURFACE.

DELTA 2*THETA FITTED TO LSE STRAIGHT LINE:

$$\text{DEL 2TH} = (1.32547) * (\text{SIN PSI})^2 + (.033)$$

ANGLE OF INCLINATION	2 THETA	SIN ²	DEL 2TH	LSE FIT
0	155.183	.000	.000	.033
15	155.380	.067	.197	.122
30	155.584	.250	.401	.364
45	155.699	.500	.516	.696
60	156.311	.750	1.128	1.027

PROBABLE ERROR OF LINEAR FIT = .088

ERROR RELATIVE TO AV. ORDINATE = 19.6 PER CENT

STANDARD DEVIATION OF STRESS = $2.2E+07$ N/M²

RELATIVE STAND. DEV. OF STRESS = 15.7 PER CENT

RESIDUAL STRESS ANALYSIS

AL BLOCK, BOTTOM WITH HOLE AS REC'D
SURFACE S2

YOUNG'S MODULUS = $7.2E+10$ N/M²; $7.3E+03$ KG/MM²; $1.04E+07$ PD/IN²

POISSON'S RATIO = .33

STRESS COMPONENT = $-1.1E+08$ N/M²; $-1.1E+01$ KG/MM²; $-1.6E+04$ PD/IN²

THIS IS A COMPRESSIVE STRESS IN THE PLANE OF THE SURFACE.

DELTA 2*THETA FITTED TO LSE STRAIGHT LINE:

$$\text{DEL 2TH} = (1.06992) * (\text{SIN PSI})^2 + (7.88835E-3)$$

ANGLE OF INCLINATION	2 THETA	SIN ²	DEL 2TH	LSE FIT
0	155.336	.000	.000	.008
15	155.427	.067	.091	.080
30	155.583	.250	.247	.275
45	155.928	.500	.592	.543
60	156.122	.750	.786	.810

PROBABLE ERROR OF LINEAR FIT = .025
ERROR RELATIVE TO AV. ORDINATE = 7.2 PER CENT

STANDARD DEVIATION OF STRESS = $6.0E+06$ N/M²
RELATIVE STAND. DEV. OF STRESS = 5.5 PER CENT

RESIDUAL STRESS ANALYSIS

AL BLOCK SLICE, SIDE OPPOSITE HOLE, CENTER
SURFACE S4/1

YOUNG'S MODULUS = $7.2E+10$ N/M²; $7.3E+03$ KG/MM²; $1.04E+07$ PD/IN²

POISSON'S RATIO = .33

STRESS COMPONENT = $-1.0E+08$ N/M²; $-1.0E+01$ KG/MM²; $-1.5E+04$ PD/IN²

THIS IS A COMPRESSIVE STRESS IN THE PLANE OF THE SURFACE.

DELTA 2*THETA FITTED TO LSE STRAIGHT LINE:

$$\text{DEL 2TH} = (.986165) * (\text{SIN PSI})^2 + (4.67392E-2)$$

ANGLE OF INCLINATION	2 THETA	SIN ²	DEL 2TH	LSE FIT
0	155.387	.000	.000	.047
15	155.567	.067	.180	.113
30	155.614	.250	.227	.293
45	156.016	.500	.629	.540
60	156.130	.750	.743	.786

PROBABLE ERROR OF LINEAR FIT = .056

ERROR RELATIVE TO AV. ORDINATE = 15.9 PER CENT

STANDARD DEVIATION OF STRESS = $1.4E+07$ N/M²

RELATIVE STAND. DEV. OF STRESS = 13.6 PER CENT

J

RESIDUAL STRESS ANALYSIS

AL BLOCK, EDGE, OPPOSITE FROM HOLE
SURFACE S1

YOUNG'S MODULUS = $7.2E+10$ N/M²; $7.3E+03$ KG/MM²; $1.04E+07$ PD/IN²

POISSON'S RATIO = .33

STRESS COMPONENT = $-1.0E+08$ N/M²; $-1.0E+01$ KG/MM²; $-1.5E+04$ PD/IN²

THIS IS A COMPRESSIVE STRESS IN THE PLANE OF THE SURFACE.

DELTA 2*THETA FITTED TO LSE STRAIGHT LINE:

$$\text{DEL 2TH} = (.994081) * (\text{SIN PSI})^2 + (-1.29431E-2)$$

ANGLE OF INCLINATION	2 THETA	SIN ²	DEL 2TH	LSE FIT
0	155.263	.000	.000	-.013
15	155.319	.067	.056	.054
30	155.491	.250	.228	.236
45	155.717	.500	.454	.484
60	156.018	.750	.755	.733

PROBABLE ERROR OF LINEAR FIT = .016
ERROR RELATIVE TO AV. ORDINATE = 5.3 PER CENT

STANDARD DEVIATION OF STRESS = $3.9E+06$ N/M²
RELATIVE STAND. DEV. OF STRESS = 3.8 PER CENT

RESIDUAL STRESS ANALYSIS

AL BLOCK, SLICE, SIDE OPPOSITE HOLE

SURFACE S5/2

YOUNG'S MODULUS = $7.2E+10$ N/M²; $7.3E+03$ KG/MM²; $1.04E+07$ PD/IN²

POISSON'S RATIO = .33

STRESS COMPONENT = $-2.6E+07$ N/M²; $-2.6E+00$ KG/MM²; $-3.8E+03$ PD/IN²

THIS IS A COMPRESSIVE STRESS IN THE PLANE OF THE SURFACE.

DELTA 2*THETA FITTED TO LSE STRAIGHT LINE:

$$\text{DEL 2TH} = (.254154) * (\text{SIN PSI})^2 + (5.13481E-2)$$

ANGLE OF INCLINATION	2 THETA	SIN ²	DEL 2TH	LSE FIT
0	155.506	.000	.000	.051
15	155.573	.067	.067	.068
30	155.703	.250	.197	.115
45	155.678	.500	.172	.178
60	155.725	.750	.219	.242

PROBABLE ERROR OF LINEAR FIT = .039

ERROR RELATIVE TO AV. ORDINATE = 29.7 PER CENT

STANDARD DEVIATION OF STRESS = $9.4E+06$ N/M²

RELATIVE STAND. DEV. OF STRESS = 36.4 PER CENT

500 DATA EXHAUSTED
NOW AT 500
READY

U.S. DEPT. OF COMM. BIBLIOGRAPHIC DATA SHEET		1. PUBLICATION OR REPORT NO. NBSIR 75-685	2. Gov't Accession No.	3. Recipient's Accession No.
4. TITLE AND SUBTITLE Improved Ultrasonic Standard Reference Blocks			5. Publication Date April 1975	
			6. Performing Organization Code	
7. AUTHOR(S) D. G. Eitzen, G. F. Sushinsky, D. J. Chwirut and C. J. Bechtoldt and A. W. Ruff			8. Performing Organ. Report No. NBSIR 75-685	
9. PERFORMING ORGANIZATION NAME AND ADDRESS NATIONAL BUREAU OF STANDARDS DEPARTMENT OF COMMERCE WASHINGTON, D.C. 20234			10. Project/Task/Work Unit No. 2130443	
			11. Contract/Grant No. DO F33615-74-M6752	
12. Sponsoring Organization Name and Complete Address (Street, City, State, ZIP) Air Force Materials Laboratory National Aeronautics and Space Administration and Army Materials and Mechanics Research Center			13. Type of Report & Period Covered Interim Report 1-1-74 to 12-31-74	
			14. Sponsoring Agency Code	
15. SUPPLEMENTARY NOTES				
16. ABSTRACT (A 200-word or less factual summary of most significant information. If document includes a significant bibliography or literature survey, mention it here.) A program to improve the quality, reproducibility and reliability of nondestructive testing through the development of improved ASTM-type ultrasonic reference standards is described. Reference blocks of aluminum, steel, and titanium alloys are to be considered. Equipment representing the state-of-the-art in laboratory and field ultrasonic equipment was obtained and evaluated. RF and spectral data on ten sets of ultrasonic reference blocks have been taken as part of a task to quantify the variability in response from nominally identical blocks. Techniques for residual stress, preferred orientation, and micro-structural measurements were refined and are applied to a reference block rejected by the manufacturer during fabrication in order to evaluate the effect of metallurgical condition on block response. New fabrication techniques for reference blocks are discussed and ASTM activities are summarized.				
17. KEY WORDS (six to twelve entries; alphabetical order; capitalize only the first letter of the first key word unless a proper name; separated by semicolons) Aluminum ultrasonic standards; ASTM-type reference blocks; fabrication of reference blocks; immersion testing; longitudinal waves; metallurgical variables; nondestructive testing, pulse-echo; steel ultrasonic standards; titanium ultrasonic standards; ultrasonics.				
18. AVAILABILITY <input checked="" type="checkbox"/> Unlimited <input type="checkbox"/> For Official Distribution. Do Not Release to NTIS <input type="checkbox"/> Order From Sup. of Doc., U.S. Government Printing Office Washington, D.C. 20402, SD Cat. No. C13 <input checked="" type="checkbox"/> Order From National Technical Information Service (NTIS) Springfield, Virginia 22151			19. SECURITY CLASS (THIS REPORT) UNCLASSIFIED	
			20. SECURITY CLASS (THIS PAGE) UNCLASSIFIED	
			21. NO. OF PAGES 82	
			22. Price \$4.75	