

NBSIR 74-617(R)

Packaging for Parcel Post

C. W. Hurley
L. G. Porter
J. J. Kramer
C. P. Goodman
M. L. Sirk

Technical Analysis Division
Institute for Applied Technology
National Bureau of Standards
Washington, D. C. 20234

November 1974

Final Report

Prepared for
Engineering Department
U.S. Postal Service
Washington, D. C. 20260

NBSIR 74-617

PACKAGING FOR PARCEL POST

C. W. Hurley
L. G. Porter
J. J. Kramer
C. P. Goodman
M. L. Sirk

Technical Analysis Division
Institute for Applied Technology
National Bureau of Standards
Washington, D. C. 20234

November 1974

Final Report

Prepared for
Engineering Department
U.S. Postal Service
Washington, D. C. 20260



U. S. DEPARTMENT OF COMMERCE, Frederick B. Dent, Secretary

NATIONAL BUREAU OF STANDARDS, Richard W. Roberts, Director

FOREWORD

The United States Postal Service (USPS) is commonly considered to be the largest industry of its kind in the world today. The almost endless variety of products which it handles and the extensive facilities it requires for processing and transportation combine to make it one of the world's most versatile distribution systems. The nature of the system in terms of size, volume of business, facilities and customer convenience is such that comparison of its services with those of other manufacturing, processing or transportation organizations is extremely difficult.

Literally millions of packages are processed daily through approximately 35,000 postal facilities in the United States. Within these postal facilities, packages are moved by various forms of mechanization depending on facility size and mail volume. At the larger modern facilities, movement of the mail is controlled and directed by special purpose computers and highly mechanized equipment.

Between postal facilities, packages are moved by every conceivable type of transportation--rail, truck, air, ship, bus and auto. On a single journey from sender to receiver, a Parcel Post package may be transported using all of these different modes of transport--each with its own distinctive operating characteristics.

Processing and transporting an infinite variety of sizes, shapes, weights and types of packages can result in unusual pressures, jolts and vibrations to individual packages, with these forces being transferred from one package to another. The effect of impact is often further complicated by changes in humidity, temperature, and atmospheric pressure.

In view of the many complicated forces acting on the parcel mail-stream, the USPS recognizes the need for continuing guidance to mailers which will help them to protect the goods or products they entrust to Parcel Post, as well as improving the service of the system upon which they depend. This Handbook--and the information which it presents--is one of several steps being taken to provide such guidance to mailers.

ACKNOWLEDGEMENTS

The project leaders wish to extend sincere thanks and appreciation to the many individuals and organizations whose hard work and outstanding cooperation over the last year have made this Handbook possible:

Field Survey

To establish Parcel Post physical packaging characteristics and their relationships to damage, a total of approximately 20,000 parcels were evaluated at ten (10) Parcel Post facilities representative of the nationwide Parcel Post System. We wish to thank all of the employees of the following facilities for their help and cooperation. Because of the large number of postal employees involved, only those individuals responsible for coordination are listed:

Atlanta - Mr. G. Ross	Oakland - Mr. P. Eng
Baltimore - Mr. W. Bloomburg	Philadelphia - Mr. J. Null
Cincinnati - Mr. J. Hassleback	Pittsburgh - Mr. B. Campbell
Columbus - Mr. J. Ritchie	Seattle - Mr. C. Donaldson
Denver - Mr. G. Cavendes	Washington, D.C. (Pilot Study) -
Greensboro - Mr. E. Lassiter	Mr. M. Thomas

The survey effort was completed during a 7 week period and involved not only the dedication of a majority of the Behavioral Sciences Group staff but also, at times, other personnel from the Technical Analysis Division of the National Bureau of Standards. The survey was made possible by the on-site participation of many Postal and NBS employees: Ms. J. Eldreth, Dr. J. Fechter, Ms. L. Freeman, Ms. C. Goodman, Ms. M. Hawkins, Dr. J. Lieblein, Dr. R. Mach, Mr. L. Mallas, Mr. T. Miller, Dr. J. Persensky, Mr. V. Pezoldt, Dr. L. Porter, Mr. R. Ramsburg, Ms. E. Robertson, Ms. M. Sirk, Ms. M. Stefl, and Ms. A. Stewart.

Data reduction and analysis efforts were ably completed by Ms. E. Clark, Ms. L. Cummings, Ms. J. Yellen, and Dr. J. Lieblein; assisted by various individuals in the NBS System Operations Section of the Computer Services Division. Special appreciation goes to Mr. J. Alepa and Ms. E. Marteau of USPS for lending a computer program to calculate distances between cities from Zip Code information.

Engineering Tests

Laboratory shock, vibration, and stacking pressure tests were conducted by staff members and students of the School of Packaging, Michigan State University (MSU), including Mr. R. Patterson and Mr. J. Dargis, under expert leadership and guidance provided by Professor J. Goff, Director. The results of these tests were used to develop many of the packaging guidelines presented in this Handbook.

Handbook Development

The project leaders are also indebted to Dr. J. Cornog, Program Manager, Behavioral Sciences Group, for participation in the planning of the project and for editing the Handbook; and to Ms. E. Bunten of that group for the final reorganization and editing. Most of all, the project could not have been undertaken or successfully completed without the support and direction of Mr. N. Griffin, USPS Program Manager; Mr. W. Rizzardi, General Manager, Industrial Engineering Division (USPS); Mr. E. Danz, Director, Engineering Department (USPS); and top management at both Division and Institute levels of NBS.

Before publishing the first packaging handbook for the Postal Service, comments and constructive inputs on the draft copies submitted were solicited from offices and departments of the Postal Service.

The External Advisory Panel was called upon for their expertise in the many areas of packaging:

Mr. Herbert Lapidus, Chairman. President of Herbert Lapidus Advisory Service, Packaging Consultants and former Chairman of the Navy Packaging Board.

Dr. James W. Goff, Professor and Director, School of Packaging, Michigan State University in East Lansing, Michigan.

Mr. Joseph F. Hanlon, Senior Packaging Engineer, Hoffman LaRoche Inc. and author of the widely used text book entitled Handbook of Package Engineering.

Mr. Peter Henningsen, Manager, Packaging. Corporate Physical Distribution. International Telephone and Telegraph Corporation.

In addition, thanks go to the following companies or associations for contributing information and visual aids, many of which appear in this Handbook:

Blocksom and Company
Dow Chemical Company
Du Pont Company
Fibre Box Association
Greif Brothers Corporation
Instapak Corporation
Jiffy Manufacturing Company
Kimberly-Clark Corporation

Joel J. Kramer
Project Manager

Marketplace International, Inc.
Niemand Brothers, Inc.
Protective Lining Corporation
Republic Packaging Corporation
St. Regis Paper Company
Sealed Air Corporation
Steel Shipping Container Institute
3 M Company

C. Warren Hurley
Project Engineer

TABLE OF CONTENTS

	<u>Page</u>
FOREWORD	ii
ACKNOWLEDGEMENTS	iii
LIST OF FIGURES	viii
LIST OF TABLES	xiii
 CHAPTER 1. Introduction	 1
 CHAPTER 2. Guidelines for Packaging Parcel Post	 5
A. General Considerations	5
B. Guidelines Table	5
C. Brief Description of the Components Listed in the Guidelines Table	15
C.1 External Containers	15
C.2 Internal Packaging Materials	26
C.3 Closures	36
 CHAPTER 3. Factors Influencing Packaging	 41
A. Introduction	41
B. Characteristics of the Product	41
B.1 Product "Value" and Packaging/Mailing Costs	42
B.2 Density of Contents and Parcel	45
B.3 Structure and Shape of Parcel and Contents	46
B.4 Fragility	46
C. Other Frequently Neglected Factors	52
C.1 Responsibility of the Mailer	52
C.2 What Can and Cannot Be Mailed	53
C.3 Mailing Nonflammable Liquids	58
C.4 Mailing Some "Problem" Products	61
C.5 Size and Weight of Parcel	63
D. Parcel Post Environment Influences	65
D.1 General Environment Influences	65
D.2 Shock/Compression/Vibration Environment	67
D.3 Temperature Environment	70
D.4 Relative Humidity Environment	70
D.5 Future Parcel Post Environment	76

TABLE OF CONTENTS (CONT.)

	<u>Page</u>
CHAPTER 4. Packaging Fundamentals	77
A. External Containers for Shipping Parcel Post	77
A.1 Rigid Containers: Drums, Fiber	78
A.2 Rigid Containers: Cans, Fiber	79
A.3 Rigid Containers: Composite Cans and Tubes	80
A.4 Rigid Containers: Cans, Metal	81
A.5 Rigid Containers: Pails, Steel	81
A.6 Rigid Containers: Boxes/Crates/Baskets, Wood	82
A.7 Semi-Rigid Containers: Boxes, Corrugated Fiberboard	83
A.8 Semi-Rigid Containers: Boxes, Solid Fiberboard	84
A.9 Semi-Rigid Containers: Boxes, Folding Cartons	85
A.10 Semi-Rigid Containers: Boxes, Set-up	86
A.11 Flexible Containers: Bags and Sacks	88
A.12 Flexible Containers: Heavy Duty Bags or Sacks	90
A.13 Flexible Containers: Envelopes	91
A.14 Flexible Containers: Shrink Wraps	91
A.15 Combination Containers	92
A.16 Miscellaneous Containers	92
B. Internal Packaging	93
B.1 Sealed Plastic Internal Containers	96
B.2 Shrinkable Plastic Film (Skin and Shrink Packaging)	97
B.3 Polyethylene Cushioning	97
B.4 Polyethylene Foam	98
B.5 Urethane Foam	101
B.6 Polyurethane Foam	101
B.7 Vermiculite	103
B.8 Bound Fiber Cushioning Materials	104
B.9 Polyvinyl Chloride (PVC)	105
B.10 Hair Felt	105
B.11 Expanded Polystyrene	105
B.12 Cushioned Wrapping	106
B.13 Plastic Foam Sheeting (Polypropylene)	107
B.14 Loose Fill	110
B.15 Wadding	113
B.16 Solid and Corrugated Fiberboard	117

TABLE OF CONTENTS (CONT.)

	<u>Page</u>
C. Closures	118
C.1 Adhesives	119
C.2 Stapling and Stitching :	121
C.3 Tapes	124
C.4 Ties	138
C.5 Strapping or Banding	139
C.6 Closing Composite Tubes and Cans	142
C.7 Secondary Closure for Glass Containers	143
D. Address Characteristics	144
D.1 Readability	144
D.2 Attaching the Label	146
E. Availability of Packaging Components	152
APPENDIX A. Temperature	154
APPENDIX B. Selection Factors for Packaging	162
APPENDIX C. List of Government Specifications	172
GLOSSARY	186
INDEX	191

LIST OF FIGURES

<u>Figure Number</u>		<u>Page</u>
1	Typical poster in a Post Office mail processing area.	1
2	An example of the Parcel Post mailstream	3
3	Inadequately packaged parcels at a Parcel Post re-wrapping station	42
4	Container broken by forces from its own contents	45
5	Well wrapped "extremely fragile" parcel which is holding its own in the mailstream	47
6	Damage boundaries for the six sides of a portable television set.	50
7	Inadequately packaged parcel being held for reclaiming by the mailer	53
8	Honeybees and chicks in the mailstream.	57
9	Damaged parcel containing one-gallon can of chocolate syrup. The can had a pry-up lid without a positive mechanical lock.	59
10	Liquid in glass containers being packaged	60
11	An "exploded" external container	61
12	Damaged parcel containing documents <u>NOT</u> internally bound	62
13	Damaged parcel containing books <u>NOT</u> internally bound	62
14	Large flat parcel entering the mailstream	64
15	Display of parcels found in the Parcel Post system	66
16	Truck being loaded for transit.	67

LIST OF FIGURES (CONT.)

<u>Figure Number</u>		<u>Page</u>
17	Delicate instrument internally packaged to prevent damage from vibration in the Parcel Post environment	69
18	Two methods of closing fiber cans	79
19	Five-gallon steel pail.	82
20	Wood crate, stapled and nailed.	83
21	Polyethylene foam bag for internal packaging . .	89
22	Bag with bubble-plastic cushioning.	90
23	Closure of plastic internal container	96
24	Polyethylene film cushioning of a glass	98
25	Corner and edge protectors of polyethylene foam .	99
26	Use of polyethylene foam.	99
27	Protection of electronic components with expanded polyethylene.	100
28	Polyethylene foam envelope.	100
29	Procedure for applying "foamed-in-place" polyurethane.	102
30	Mold formed by polyurethane foam-in-place process	103
31	Use of six pads of rubberized hair for packaging a fragile item.	104
32	Polystyrene corner pads	106
33	How to use self-sticking, single-faced, corrugated wrap	108
34	Wrapping a glass vase in polypropylene sheeting .	109

LIST OF FIGURES (CONT.)

<u>Figure Number</u>		<u>Page</u>
35	Shredded newspaper used as loose fill	110
36	Polystyrene loose fill.	112
37	Packing with loose fill	114
38	Cellulose wadding protecting the contents of a mailing tube.	115
39	Preparation for wrapping with cellulose wadding .	116
40	Use of crumpled newspaper as wadding.	117
41	Proper adhesive application for a regular slotted container	120
42	Two types of staples.	121
43	A potential hazard in the mailstream created by improper application of a staple.	122
44	Stapling or stitching the bottom closure of a regular slotted container	123
45	Stapling/Stitching the closure of an overlap flap container.	123
46	Taping a reused container	125
47	Results of improperly wetting and applying tape .	126
48	Ruptured nonreinforced gummed tape on a parcel where end closing strips were not applied	128
49	Applying nonreinforced gummed paper tape and nonreinforced paper or cloth pressure sensitive tape.	128
50	Proper method of applying reinforced gummed tape, and nonreinforced pressure-sensitive plastic tape	129

LIST OF FIGURES (CONT.)

<u>Figure Number</u>		<u>Page</u>
51	Pressure-sensitive filament tape used as carton closure and reinforcement.	131
52	Banding two parcels to form one parcel using pressure-sensitive filament tape.	132
53	Application of gummed reinforced or pressure sensitive polyester on a regular slotted container	133
54	Application of gummed or pressure-sensitive tape on a regular slotted container.	133
55	Application of filament tape "L" and "C" clips to close and reinforce a long and/or heavy box .	134
56	Application of pressure-sensitive or gummed paper tape, or pressure-sensitive polyester tape to a one-piece folder	134
57	Application of tape to a five-panel folder. . . .	135
58	Full telescope box with "L" clip tape closure . .	136
59	Full overlap box with pressure-sensitive or gummed paper tape closure	136
60	Application of tape to a paper-wrapped parcel . .	137
61	Tying procedure	138
62	Appropriate use of steel strapping.	140
63	Relationships between box dimensions and number of straps	141
64	Mailing tubes with cuff closures.	143
65	Use of tape as a secondary closure for glass containers.	143
66	Inadequately applied address label.	146

LIST OF FIGURES (CONT.)

<u>Figure Number</u>		<u>Page</u>
67	Parcel from which an inadequately applied address label has been lost	146
68	Tag inadequately secured with yarn.	149
69	Use of transparent label tape	150

LIST OF TABLES

<u>Table Number</u>		<u>Page</u>
1	Guidelines Table	6-14
2	Fundamental Frequencies Experienced by Parcels in Transportation	69
3	Climate Conditions June Through September . . .	72-75
4	Numbers and Heights of Flutes in Corrugated Fiberboard	84
5	Relationship of Weight of Contents to Thickness and Basis Weight for Set-Up Paperboard Boxes . .	87
6	Qualitative Performance Characteristics	94
7	Steel Strapping Sizes (Flat and Round)	140

CHAPTER 1

INTRODUCTION

Prompt delivery of Parcel Post packages in good condition is the aim of the U.S. Postal Service. Thousands of clerks and mail handlers have been trained to forward mail quickly and with as much care as the system can provide. The Postal Service accepts millions of parcels daily for world-wide, national and local handling. This does not permit continual attention to be given each parcel. The responsibility for careful handling and proper delivery within a reasonable period of time belongs to the Postal Service.

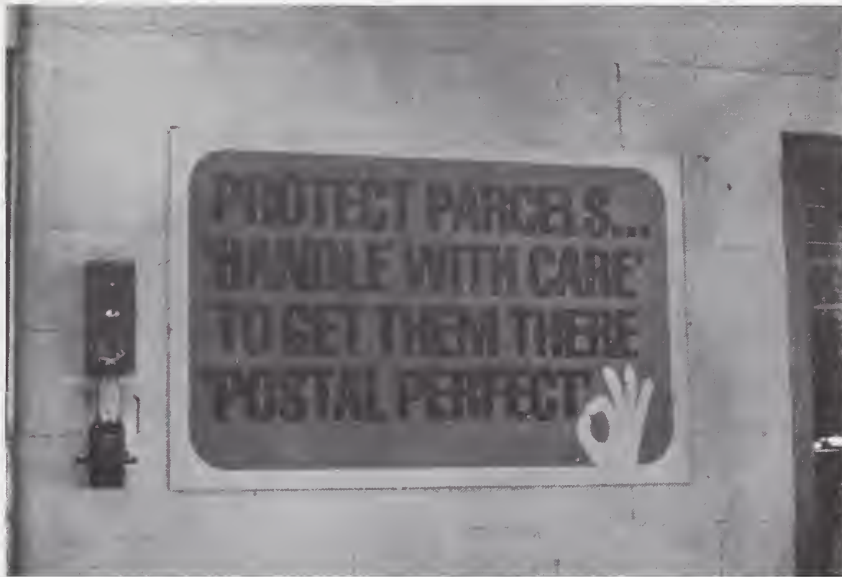

Figure 1. Typical poster in a Post Office mail processing area. (NBS)

The responsibility for preparing an adequate package to present to the Postal Service for delivery belongs to the mailer. The purpose of this Handbook is to present information and suggestions that will help the mailer with packaging problems and promote better packaging in general.

Preparation of a good package depends primarily on four things:

(1) Familiarity with the characteristics of the items to be packaged.

What are the chances of products surviving if the parcel experiences impacts, vibrations, very hot or cold weather, delays in transit, or has much heavier parcels as neighbors in the mailstream? The mailer can answer many of these questions if he is familiar with the basic characteristics of the goods he is packaging.

(2) Previous experience in mailing similar products.

If the mailer has ever mailed the same or similar items or even sent other items to about the same address at other times, he may have some idea of the packaging materials and methods that have been satisfactory. Did an addressee complain of damage to contents or to the container? Was there a need for better cushioning of the contents or for better support inside the container? Experience with previous mailings may be a guide.

(3) Proper choice of Packaging Materials.

Whether or not the mailer has had previous experience in mailing other parcels with similar contents to the same area, he must choose the necessary packaging materials for any merchandise he mails. Before preparing the parcel, the mailer should obtain current information on the many kinds of materials available and how they should be applied. The type, style, or grade of container; the type and amount of internal packaging; the kind of closing or sealing that is needed; all will have to be selected. It may also be necessary to reinforce the parcel on the inside if the combined strength of the contents and container are not self-supporting.

(4) Skill and workmanship.

Good packaging materials alone will not do the job of protecting the contents. Materials have to be put together with enough care and knowledge of their use to serve as the first line of defense against possible crushing or breaking open of the package under normal shipping conditions. The container must be assembled to take advantage of its design strengths; parcel contents must be internally packaged to prevent shifting or the concentration of forces on the walls of the container; fastener staples should be clinched or blunted to avoid injury to mail handlers or to other parcels; tapes must be applied so they stick firmly and cover the openings of the container to provide the maximum strength.

As shown in Figure 2, Parcel Post mail moves like a stream in and out of post offices through a series of chutes, conveyors, trucks, tubs, containers and other devices. If the packaging is adequate, the parcel can be moved forward rapidly and safely with no hold-ups for rewrapping, for gathering scattered contents, or for additional time to read an address that is almost unreadable. The good package offers a clean, uncluttered surface for the mailing information: the sender's and receiver's names and addresses, any required labels or markings, and the stamps or postage meter strips including ZIP codes. The good package also provides a surface which protects postal workers from injury. Both the surface and the way in which the contents are packaged protect other parcels from damage while maintaining the security of the contents.



Figure 2. An example of the Parcel Post mailstream.

(NBS)

This Handbook is offered as a guide to mailers in their preparation of packages. In Chapter 2, guidelines are presented which suggest materials that should be used in preparing a package to protect almost any kind of product. Influences on the packaging process are discussed in Chapter 3. The type of product or goods to be enclosed, the shape and structure of the parcel and of the contents, packaging of fragile goods and care of perishable items, all receive at least brief treatment. Information is also given on the effects of the post office environment on the parcel.

Various kinds of packaging materials are described in Chapter 4: types of containers; internal packaging materials; closing, sealing and reinforcing tapes; ties; banding and strapping. The Handbook also contains a Glossary in which important terms are defined, and Appendices for reference.

International mail has packaging requirements for size, weight, mailing limitations, and documentary requirements which differ from domestic parcel post. Consult your Customer Service Representative at your local post office for the latest international mailing requirements for the country to which you intend to send parcel post. Many of the packaging methods shown in this Handbook are acceptable for international mailing.

This Handbook is intended to serve as a handy guide whenever the mailer has to package something he has not mailed or has not mailed successfully before. Hopefully, it will help large mailers to reduce their mailing costs by suggesting lighter weight or more substantial materials that will lower postage charges, lower the costs of packaging materials, and reduce parcel damage. References are provided for those readers who wish to make further inquiry into what appears in this volume. You, as the mailer, are responsible for getting that parcel off to a good start!

CHAPTER 2

GUIDELINES FOR PACKAGING PARCEL POST

A. GENERAL CONSIDERATIONS

- The mailer is responsible for providing adequate protection to the contents of a parcel.
- The size of the container used for mailing must be adequate to contain the item(s) and provide enough space for adequate cushioning material if needed. If the external shipping container is too large and the contents are not properly blocked and/or cushioned, the contents will shift in transit and subject the walls and closure to extreme forces which often lead to failure. If the container is too small, adequate cushioning cannot be applied and container failure is likely to occur.
- Always use good quality containers.
- Fragile items must be packaged to withstand the environment of Parcel Post processing and transportation.
- Books and documents must be tied or banded together (unitized) before they are placed in a container to be mailed.
- Markings on a container which interfere with or obscure the addressee, the mailer, the nature of the contents and handling are not permitted. Obsolete markings must be obliterated.
- When mailers are in doubt as to whether any item isailable, the adequacy of packaging, or anything pertaining to the parcel to be mailed, they should consult their local postmaster or his customer service representative.

B. GUIDELINES TABLE (Table 1)

This section presents a table which lists several common classes of products and gives codes for suggested containers, internal packaging, and closures to be used when mailing those items within the U.S. Section C, which follows the Guidelines Table, gives pictures and brief descriptions of the packaging materials coded in the Table. The suggestions given in the Table are not necessarily the only proper ways of packaging a specified product. They are, however, examples of packaging which are expected to survive and to protect the specified product as it travels through the Parcel Post system. Please note that the Guidelines Table is intended only for mailings within the U.S. The mailer should contact his local postmaster for information about packaging for overseas mail. Also note that Sections B and C are only brief descriptions. See Chapter 4 for further detail.

HOW TO USE THE TABLE. Several categories and sub-categories of products are listed on the next 8 pages:

- Find the name of the product to be mailed (or similar product) in the Table. Then in the next column, choose the appropriate size, weight, or number of products to be packaged.
- To the right of the product name and limitations are three other columns. Each column shows numbers or letters which refer to packaging materials described in Section C (pp. 15-40).
- o External Package--different types of shipping containers or cartons. (Numbers refer to descriptions on pages 15-25.)
- o Internal Package--internal cushioning, reinforcing, or supporting materials. (Capital letters refer to descriptions on pages 26-35.)
- o Closures--methods and materials for closing the completed parcel. (Small letters refer to descriptions on pages 36-40.)
- Using the numbers and letters of the suggested packaging materials for that product, refer to Section C (pp. 15-40) for brief descriptions. See Chapter 4 for more information.

CODES USED IN THE TABLE. Listed below are the codes, names and page references (Chapter 2) of the external packages, internal packaging materials, and closures used in the Guidelines Table.

EXTERNAL PACKAGE

- 1 Regular Slotted, p. 15
- 2 Overlap Slotted, p. 15
- 3 Full Overlap Slotted, p. 16
- 4 Box With Cover, p. 16
- 5 Partial Telescope, p. 17
- 6 Full Telescope, p. 17
- 7 1, 2, & 3 Piece Folders, p. 18
- 8 Five Panel Folder, p. 18
- 9 Bookpack, 19
- 10 Single-face Corrugated Bag, p. 19
- 10A Unpadded Bag, p. 19
- 11 Cushioned Paper Bag, p. 20
- 12 Paper Bag (Bubble Cushion), p. 21
- 13 Film-pack, p. 21
- 14 Record Pack, p. 22
- 15 Wood Container or Crate, p. 22
- 16 Cleated Plywood Box, p. 23
- 17 Drum/Can/Pail, p. 24
- 18 Mailing Tube, p. 25
- 19 Textile Bags, p. 25

INTERNAL PACKAGE

- A Corrugated Partitions, p. 27
- B Corrugated Liner Pads, p. 27
- C Corrugated Packing Forms, p. 28
- D Corner Pads or Protectors, p. 29
- E Single-face Corrugate Cushion, p. 29
- F Single-face Cushion (Latex), p. 30
- G Wadding, p. 30-31
- H Loose-fill Materials, p. 31
- I Plastic Foam Sheetting, p. 32
- J Expanded Polystyrene, p. 33
- K Polyethylene Film Cushioning, p. 33
- L Urethane or Polyethylene Foam, p. 33
- M Self-Forming, Foamed Cushion, p. 33
- N Vermiculite, p. 33
- O Rubberized Bound Fiber, p. 34
- P Sealed Plastic Container, p. 35

CLOSURE.

- a Adhesives, p. 36
- b Paper Tapes, p. 36
- c Reinforced Gunned Tape, p. 37
- d Pressure Sensitive Plastic or Filament Tape, p. 38
- e Stitching, p. 38
- f Stapling, p. 39
- g Locking Tab, p. 40
- h Cuffs, p. 40
- i Metal Clips, p. 40
- j Plastic or Metal Banding, p. 40

PRODUCT OR CONTENTS MAILED	LIMITATIONS	EXTERNAL PACKAGE	INTERNAL PACKAGE	CLOSURES
AEROSOLS¹ (Such as insecticides, fungicides, herbicides, paints, lacquers, cosmetics, medicals.)	Single Units Multi Units	(1-6)*, 18 { 1-6 15, 16 }	G, H, O A + Absorbent A + Absorbent	a, c, d c, d, e } j }
AUTOMOTIVE PARTS²	Single Units: up to 15 lbs. up to 40 lbs. Multi Units: up to 20 lbs. up to 70 lbs.	1-6 1-6 1-6 1-6, 15, 16	B, C, E, G, H C, D, J, M A A	c, d, e j c, d, e j
BOOKS AND PAPER ITEMS³				
Paper, documents, journals.	Up to 5 lbs.	7-12	None	c, d, e, f, g
	Up to 40 lbs.	1-6	B	c, d, j
Books, blueprints, posters, maps, calendars, photographs, computer cards.	Up to 5 lbs.	{ 7, 8, 9, 10A 11,12,14,18 }	B None	b, c, d c, d, e, h } }
	Up to 40 lbs.	1-6	B	a, c, d

¹Consult local postmaster for restrictions and special packaging requirements.

²Loads in excess of 15 lbs. must be packaged so as not to exert pressure in excess of 60 lbs. per square foot on any area of the container.

³In all cases, multiple items must be internally bound before being put in the shipping container.
*1, 2, 3, 4, 5, or 6

PRODUCT OR CONTENTS MAILED	LIMITATIONS	EXTERNAL PACKAGE	INTERNAL PACKAGE	CLOSURES
COMBUSTIBLE & GASEOUS SUBSTANCES, MATCHES ¹				
COSMETICS ¹	Single Units	{ (1-6)*10 } 11, 18 }	C, G, H	a, c, d
	Multi Units	1-6	A + Absorbent	a, c, d, e
CUTTING INSTRUMENTS ¹ (Such as knives, axes, scissors.)	Single Units	1-6	B, C, D, E, G	c, d, e
	Multi Units	1-6	A, B, F, G, O	a, c, d, e
DRUGS & PRESCRIPTION MEDICINES ¹	Single Units	18	G	a, b, c, d
	Multi Units	1-6	A + Absorbent	c, d, e
ELECTRICAL APPLIANCES (SMALL) (Such as toaster, knife, blender, can opener.)	Single Units	1-6	B, C, D, I	c, d, e
	Multi Units	1-6	A + G	c, d, e

¹Consult local postmaster for restrictions and special packaging requirements.

*1, 2, 3, 4, 5, or 6

PRODUCT OR CONTENTS MAILED	LIMITATIONS	EXTERNAL PACKAGE	INTERNAL PACKAGE	CLOSURES
ELECTRICAL APPLIANCES (LARGE) (Such as portable radios, television, phonographs, dehumidifiers, humidifiers.)	Up to 5 lbs. Up to 40 lbs.	(1-6)* { 1-6 15, 16	B, C, E, G, H B, C, D, I, M B, C, D, I, M	c, d, e c, d, e j
ELECTRONIC COMPONENTS (Such as electronic circuits, electronic components, computer components.)	Single Units Multi Units	1-8 1-6	B, C, E, H, I A + F, G, H	c, d, e c, d, e
FEEDS AND SEEDS (Such as bird seed.)		{ 5, 6 17	P + (G, H) P + (G, H)	c, d, e i
FIREARMS ¹				
FOOD ¹ (Such as dairy products, fresh fruits and vegetables, frozen and freeze dried foods, meats, fish, poultry and poultry products, canned products, cereals, beverages, candies - hard and soft, cookies.)		{ 1-6 17	P P	a, c, d e, f, i

¹Consult local postmaster for restrictions and special packaging requirements.

*1, 2, 3, 4, 5, or 6

PRODUCT OR CONTENTS MAILED	LIMITATIONS	EXTERNAL PACKAGE	INTERNAL PACKAGE	CLOSURES
FURNITURE				
Lamp and lamp shades		(1-6)*	C	a, c, d
Other small furniture		{ 1-6 15, 16	D, E, F, G, I C, D, E, F, I	a, c, d j
Small office equipment (Such as calculators, typewriters, etc.)		{ 1-6 15, 16	C, D, M, O C, D, E, F, I	a, c, d j
FURS, HIDES, SKINS, OR PELTS¹				
		1-6	B, G	c, d
GLASSWARE				
(Such as ceramics, china- ware, glassware, pottery, lightbulbs, optical lenses.)	Single Units	1-6	C, G, H, I	c, d
	Multi Units	1-6	A + (F, G, I)	c, d
HARDWARE				
(Such as nuts, bolts, screws, nails, rivets.)	Up to 20 lbs.	5-6	G	c, d
	Up to 70 lbs.	{ 5-6 15, 16 17	G G G	j i

¹Consult local postmaster for restrictions and special packaging requirements.

*1, 2, 3, 4, 5, or 6

PRODUCT OR CONTENTS MAILED	LIMITATIONS	EXTERNAL PACKAGE	INTERNAL PACKAGE	CLOSURES
JEWELRY				
	Single Units	(1-8)*, 18	B, C, (F + G) I	a, c, d
	Multi Units	1-8	(A + G), (F + G)	a, c, d
LABORATORY EQUIPMENT				
	Single Units: up to 5 lbs. up to 40 lbs.	1-8 { 5, 6 15, 16	C, G, H, I C, D, E, F, M C, D, E, F, M	a, c, d c, d j
	Multi Units	{ 5, 6 15, 16	A + (F, G, I, O) A + (F, G, I, O)	c, d j
LABORATORY SAMPLES¹				
	Single Units	1-8, 18	G, I, (P + G)	a, c, d
	Multi Units	1-8	A + (G, I, P)	c, d
LIQUIDS¹ (Such as paints, varnishes, janitorial liquids, non-hazardous chemicals, printing inks, motor oil.)				
	Up to 1 gal.	1, 18	C, G, (P + G)	c, d, i
	1 gal. to 5 gal.	17	none	i
LIVE ANIMALS¹				

¹Consult local postmaster for restrictions and special packaging requirements.

*1, 2, 3, 4, 5, 6, 7 or 8

PRODUCT OR CONTENTS MAILED	LIMITATIONS	EXTERNAL PACKAGE	INTERNAL PACKAGE	CLOSURES
LIVE INSECTS ¹ (Such as queen bees, honey bees, crickets.)				
MUSICAL INSTRUMENT	Up to 5 lbs.	(1-6)*	C, G, I, O	c, d
	Up to 40 lbs.	{ 1-6 15, 16	B, C, G, M B, C, G, M	c, d } j }
PLANTS ¹ - Ask Local Postmaster for Postal Bulletin No. 14 for special regulations.				
POWDERS ¹ (Such as ink powders, pepper, salt, pulverized materials.)	Up to 5 lbs.	5, 6	P + (G, H)	c, d (add sealing)
	Up to 40 lbs.	{ 5, 6 15, 16 17	B + P + (G, H) P + (G, H)	j } i } (add sealing)
RADIOACTIVE MATERIALS ¹ - Ask your Local Postmaster for Postal Bulletin No. 6 for special regulations.				
RECORDINGS				
Phonograph records		14	B	a, c, d
Magnetic recording tapes, ² movie and other film		13	B	g

¹Consult local postmaster for restrictions and special packaging requirements.

²See Chapter 3 for further information.

*1, 2, 3, 4, 5, or 6

PRODUCT OR CONTENTS MAILED	LIMITATIONS	EXTERNAL PACKAGE	INTERNAL PACKAGE	CLOSURES
SCIENTIFIC INSTRUMENTS	Single Units	(1-8)*, 18	B, C, D, G, I H-M, O	a, c, d
	Multi Units (Packaged)	1-7	A + G	c, d
SOFTGOODS ¹ (Such as textiles, clothing & apparel, hats & hosiery, curtains, rugs, blankets, pillows, leather products, shoes, purses, boots.)		1-8, 10-12 15, 16	C where appli- cable	c, d, e, f j
SPORTING EQUIPMENT	Up to 5 lbs.	1-8	B, C, E, G, H	c, d, e
	Up to 40 lbs.	{ 1-6 15, 16	B, C, D, I, M B, C, D, I, M	c, d, e j
TOBACCO PRODUCTS		{ 1-6 17 18	P + (G, H) P + (G, H) P + (G, H)	c, d i c, d

¹Use self-supporting container or provide ventilation.

*1, 2, 3, 4, 5, 6, 7, or 8

PRODUCT OR CONTENTS MAILED	LIMITATIONS	EXTERNAL PACKAGE	INTERNAL PACKAGE	CLOSURES
TOOLS¹				
	Single Units: up to 15 lbs. up to 40 lbs.	(1-6)* { 1-6 15, 16	C, D, G, H C, D, J, L, M C, D, J, M	c, d, e c, d } j }
	Multi Units: up to 20 lbs. up to 70 lbs.	{ 1-6 15, 16	A + (G, H) A + (G, H)	c, d, e } j }
TOYS²				
		1-7	C, G, H, I, K	c, d, e

¹ Loads in excess of 15 lbs. must be packaged so as not to exert pressure greater than 60 lbs. per square foot on any area of the container.

² Use self-supporting container.

*1, 2, 3, 4, 5, or 6

C. BRIEF DESCRIPTION OF THE COMPONENTS
LISTED IN THE GUIDELINES TABLE

C.1 EXTERNAL CONTAINERS

This section includes short descriptions of external containers referred to in the Guidelines Table (Section B). The number in the box to the left of each description corresponds to the codes used in the Guidelines Table. For additional information please see Chapter 4.

- 1 Regular slotted container. Outer flaps are of the same length and join at the center as shown below.

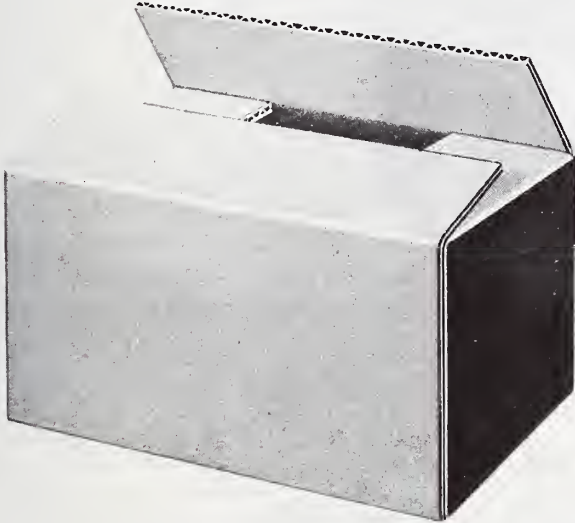

(Courtesy, Fibre Box Assn.)

- 2 Overlap slotted container. The outer flaps overlap as shown.



(Courtesy, Fibre Box Assn.)

- 3 Full overlap slotted container. Outer flaps are of the same length and completely overlap.

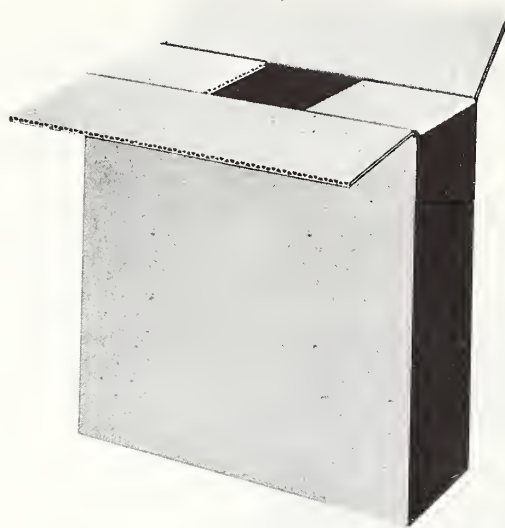

(Courtesy, Fibre Box Assn.)

- 4 Box with cover. Two piece box. The cover extends over body less than two-thirds of depth.

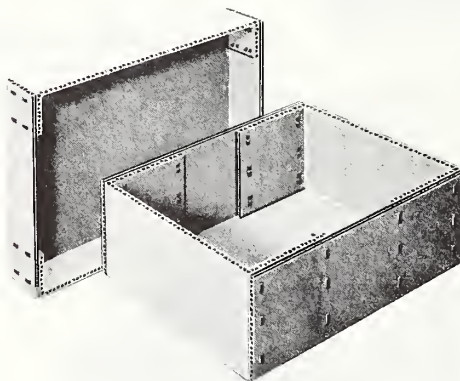

(Courtesy, Fibre Box Assn.)

- 5 Partial Telescope. Two piece box. The cover extends at least two-thirds of depth.

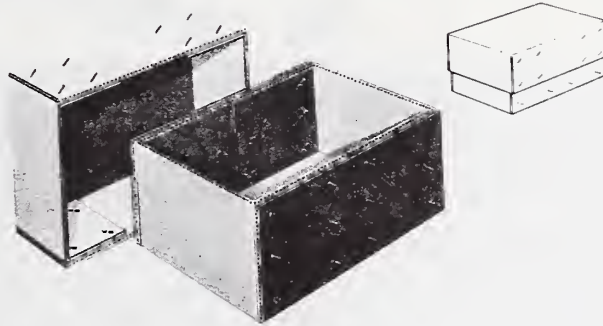

(Courtesy, Fibre Box Assn.)

- 6 Full Telescope. Two piece box with full depth cover.

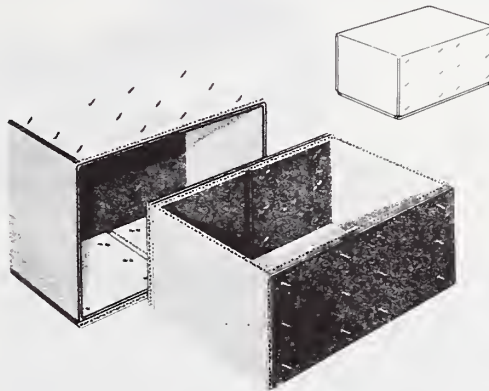

(Courtesy, Fibre Box Assn.)

7 One, Two, and Three Piece folders.

One Piece

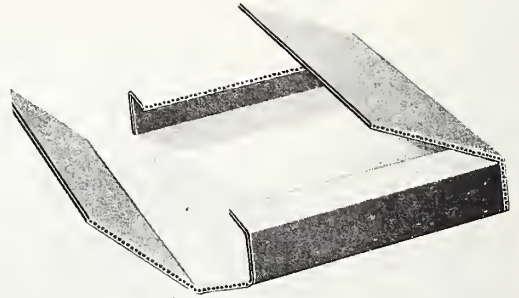

Two Piece

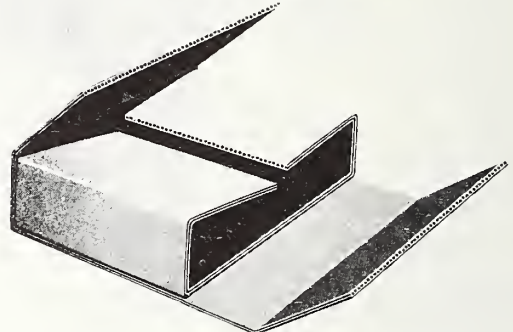

Three Piece

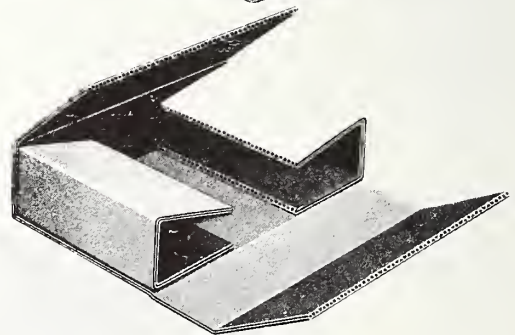

(Courtesy, Fibre Box Assn.)

8 Five panel folder.

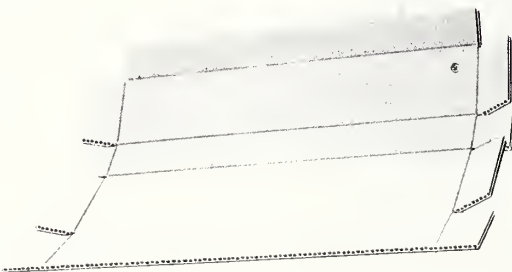

(Courtesy, Fibre Box Assn.)

- 9 Bookpack. A container designed to package a book. See the previous illustrations of the one, two, and three piece folders.
- 10 Single-faced corrugated bag. A bag made of single-faced corrugated material with the smooth face outward.



(Courtesy, St. Regis Paper Co.)

- 10A Unpadded Bag. A flat, laminated design in which layers of one or more materials are pressed together.



(Courtesy, Jiffy Manufacturing Co.)

11

Cushioned Paper Bag. These bags are usually made with two or more layers of paper, with cushioning material between the layers, as shown below.

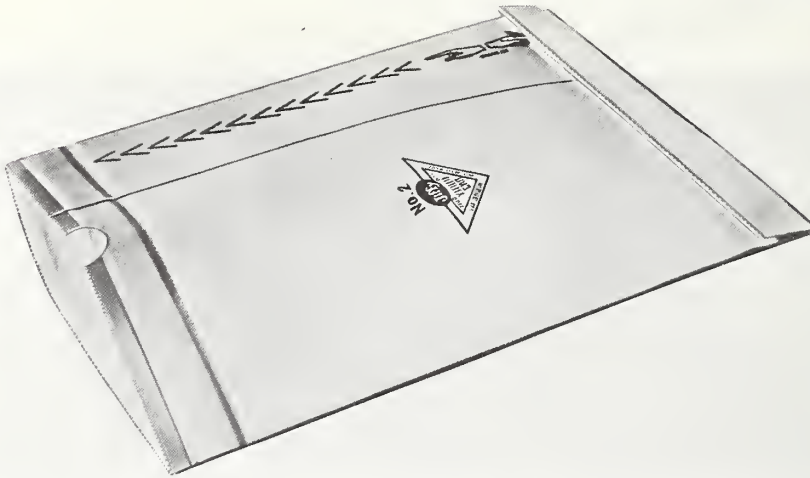

(Courtesy, Jiffy Manufacturing Co.)



(NBS)

Paper bag with internal filler material for cushioning.

12 Paper Bag with Internal Plastic Bubble Cushioning material.

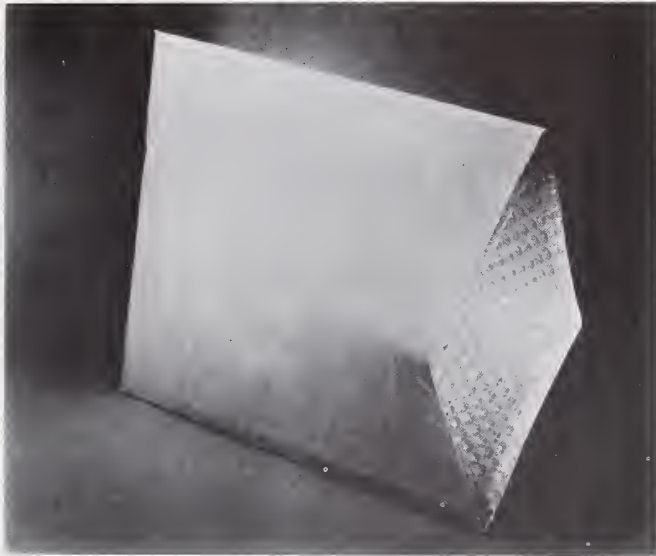

(Courtesy, Sealed Air Corp.)

13 Filmpack.

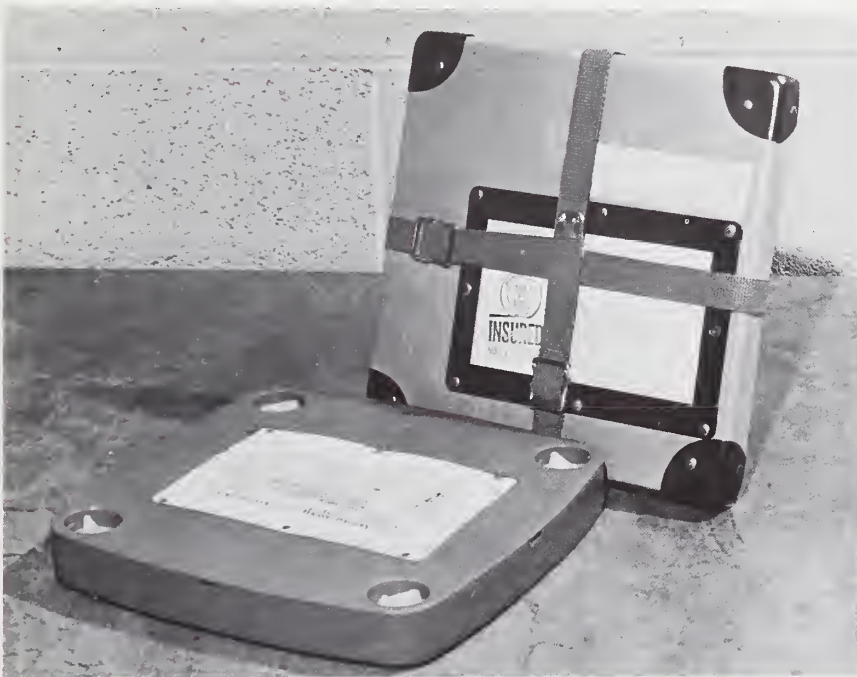

(NBS)

14 Record Pack.

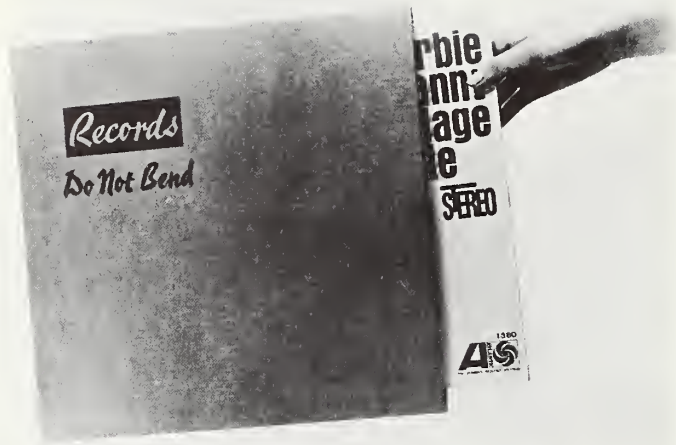

(Courtesy, St. Regis Paper Co.)

15 Wood container or crate. A container constructed of wood fastened together by nails, wire or staples.

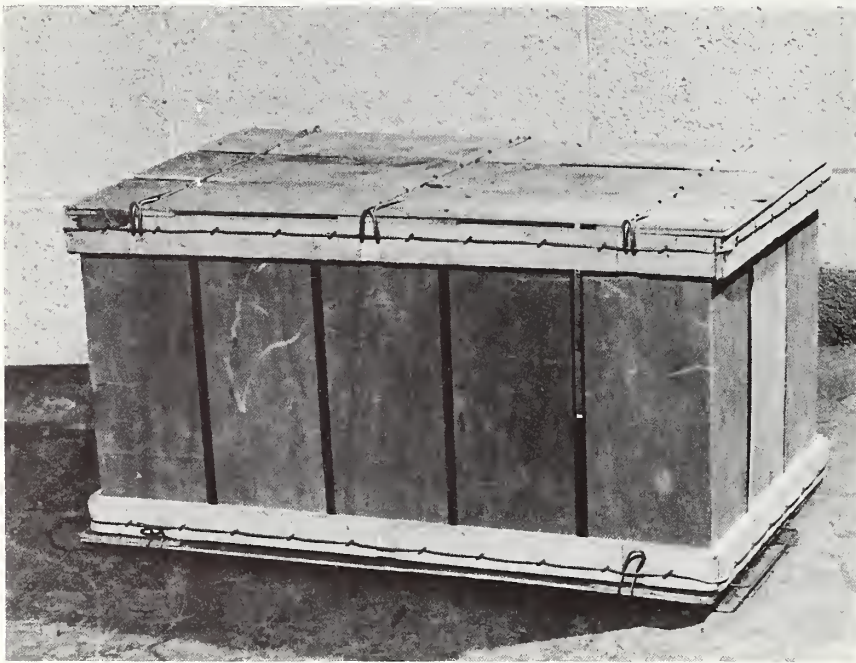

(Wire bound box)

(NBS)

- 16 Cleated Plywood box. The box has six panel faces with wood cleats fastened to them.

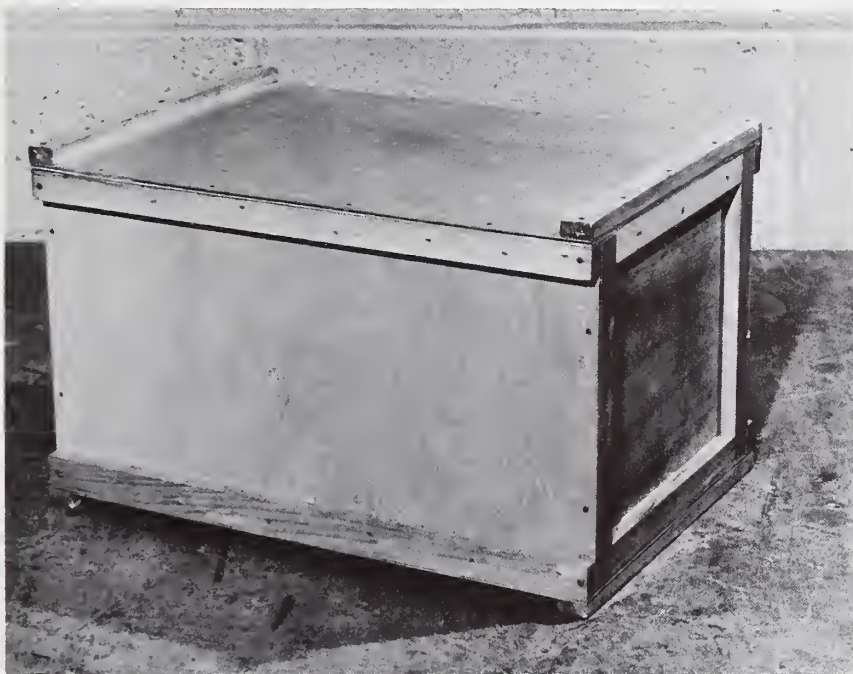

(Exposed external cleats as shown on the top and bottom of this box damage other mail and such boxes are to be avoided. Internal cleats are acceptable.)

(NBS)

17

Drum/Can/Pail. A cylindrical container with straight sides and flat ends. Some examples of the many types are:

- (1) fiber drums made of fiberboard material; and
- (2) metal cans, drums, or pails made of steel or aluminum.
- (3) composite fiber cans and tubes made of paper or paperboard alone or in combination with other materials.



(Courtesy, Grief Brothers Corp.)



(Courtesy, Steel Shipping
Container Institute Inc.)

18 Mailing Tube. Mailing tube is a small cylindrical container.



(Courtesy, Niemand Brothers Inc.)

19 Textile bags. Typically made from burlap or cotton and synthetic fibers.

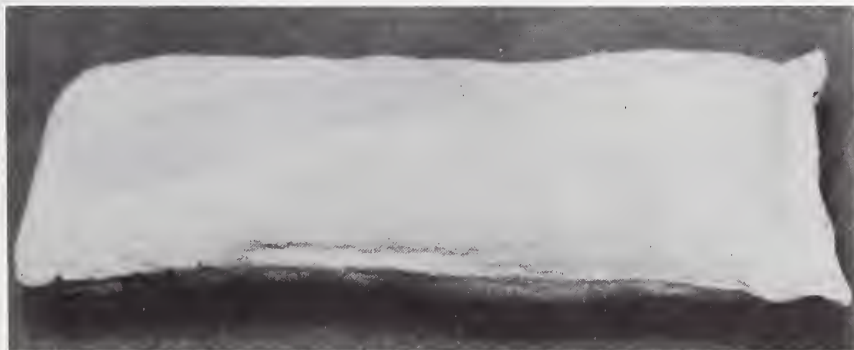

C.2 INTERNAL PACKAGING MATERIALS

This section provides short descriptions of internal packaging materials referred to within the Guidelines Table. The letters in the box to the left of each description corresponds to the codes in the Table. For additional information see Chapter 4.

Corrugated fiberboard. Can be single, double, or triple walled, depending on the reinforcement needed as shown below.

SINGLE-WALL CORRUGATED



DOUBLE-WALL CORRUGATED

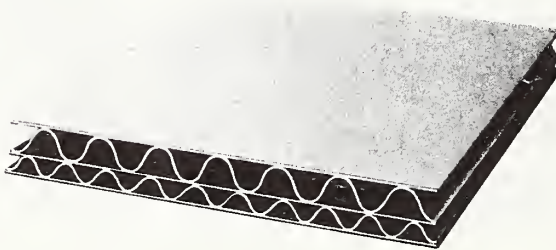

TRIPLE-WALL CORRUGATED

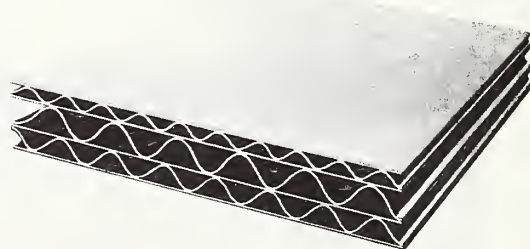

Three types of corrugated fiberboard.

(Courtesy, Fibre Box Assn.)

A Corrugated partitions. Used to separate individual items within a container and protect them from internal as well as external damage.

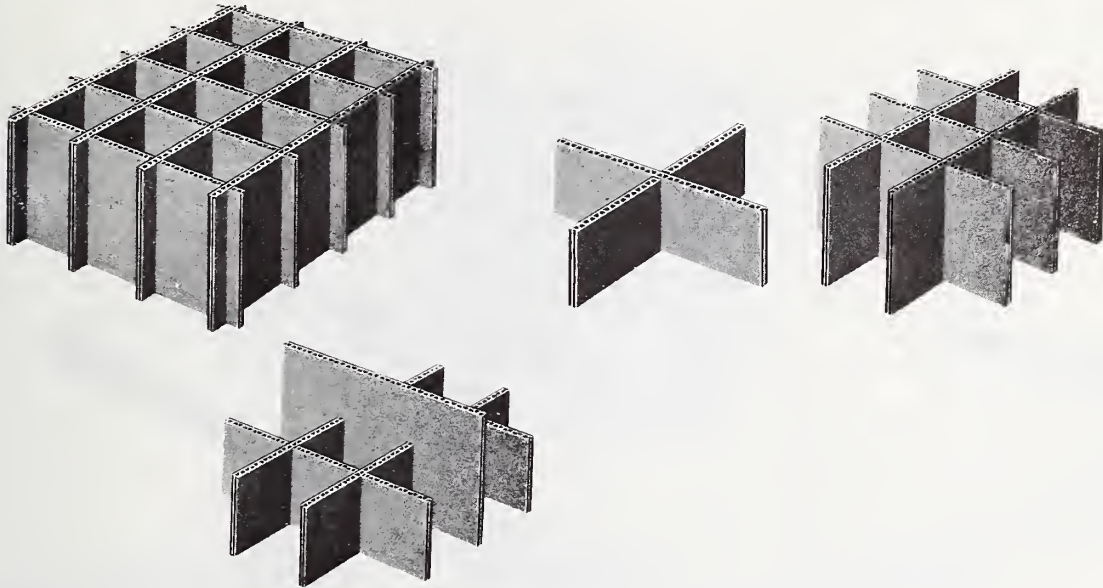

(Courtesy, Fibre Box Assn.)

B Corrugated liner pads. These can be flat, folded, or formed into various shapes. They suspend the article within the container and away from the walls.

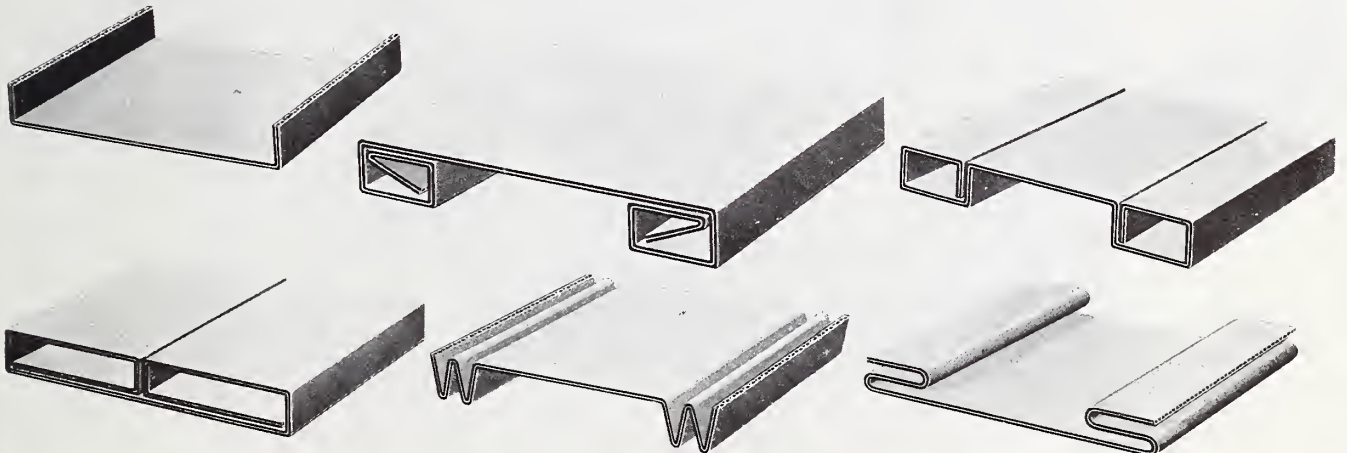

(Courtesy, Fibre Box Assn.)

C Specially designed corrugated packing forms. Below are a few examples.

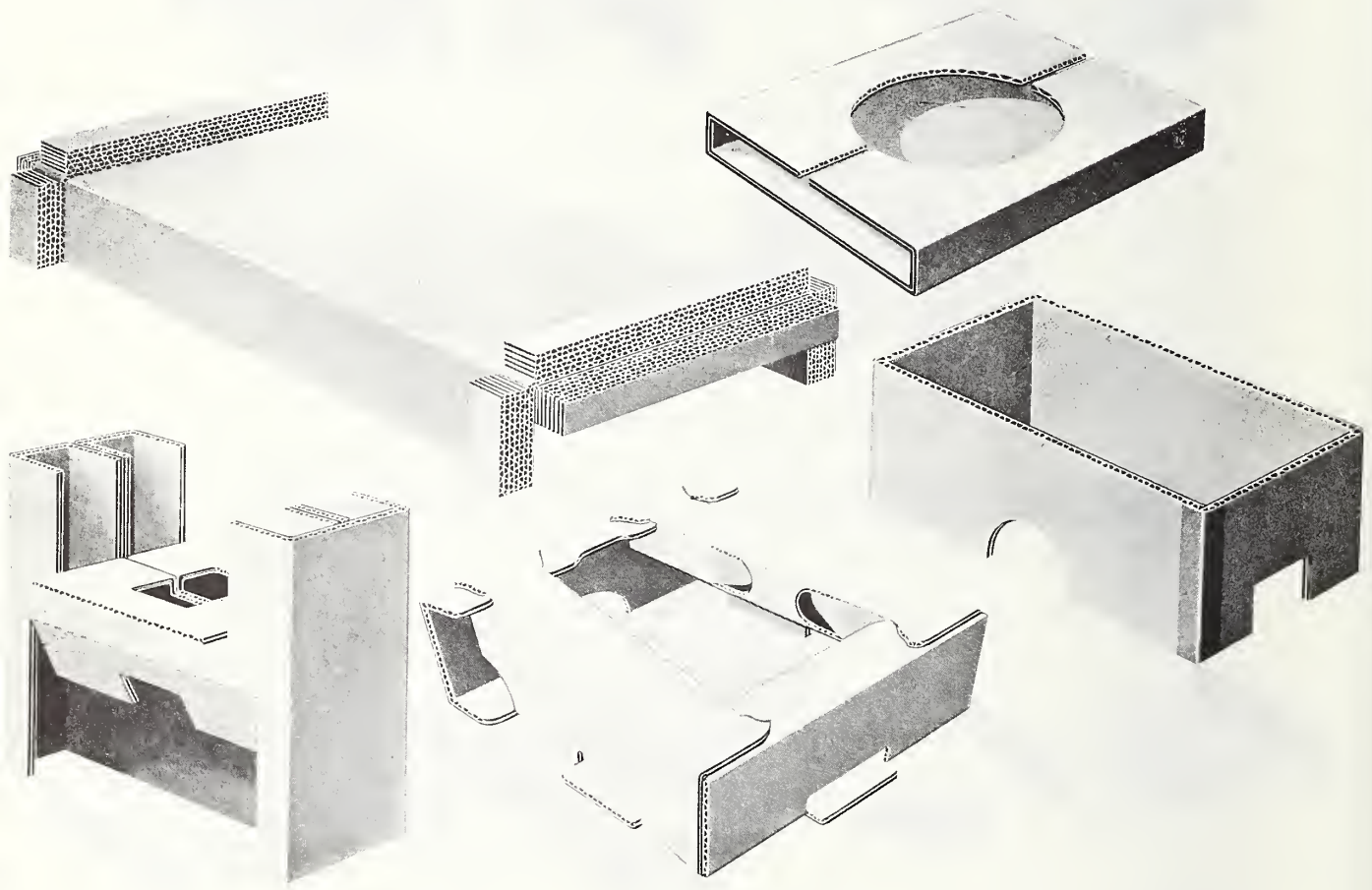

(Courtesy, Fibre Box Assn.)

- D Corner pads or protectors. These are often made from corrugated fiberboard, but several other materials can be used.

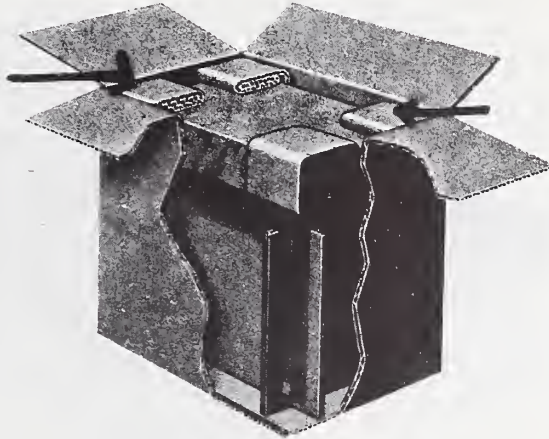

(Courtesy, Fibre Box Assn.)

- E Single-faced corrugated cushioning. Used to protect the surface of product.

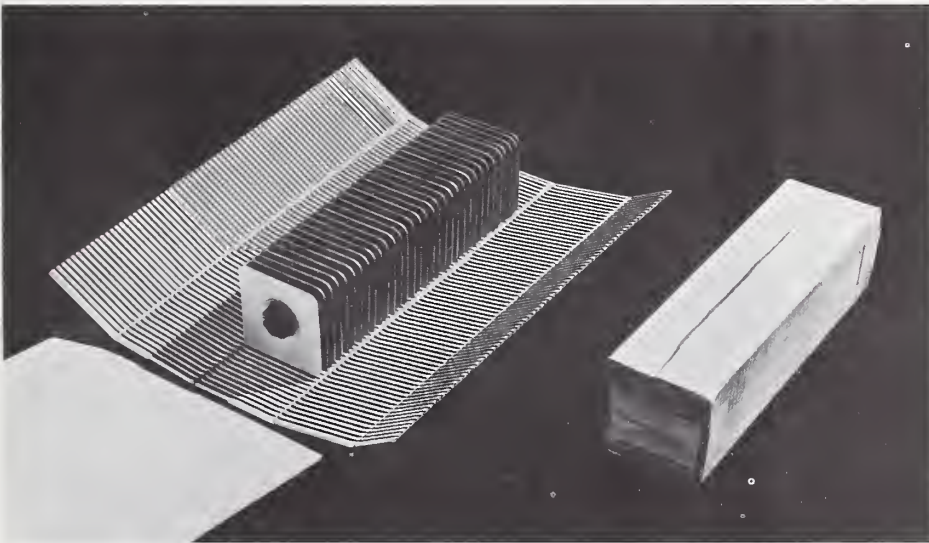

(Courtesy, St. Regis Paper Co.)

- F** Single-faced cushioning with a latex coating. This material sticks only to itself and not to the article. Used mainly to protect surface of item.



(Courtesy, St. Regis Paper Co.)

Non-Corrugated; self-adhering, single-faced cushioning.

- G** Wadding. Various types include:

1. Plastic wadding
2. Cotton wadding
3. Newspaper or kraft paper wadding
4. Cellulose wadding
5. Crepe paper wadding

These materials usually come in roll or sheet form as shown and in a variety of sizes and thicknesses.



Sheet Wadding.

(Courtesy, Jiffy Manufacturing Co.)

G Wadding. (Continued)



Roll Wadding.

(Courtesy, Jiffy Manufacturing Co.)

- H** Loose-fill materials. Some examples are: (1) shredded newspaper; (2) excelsior; and (3) polystyrene.



(Courtesy, Dow Chemical Co.)

Proper use of loose-fill material.

I Plastic foam sheeting is a flexible, capsulated air-filled, cellular material.



Use of plastic foam sheeting.

(Courtesy, Du Pont and Co.)

- J Expanded polystyrene. Rigid material usually used for support, suspension, or mounting.
- K Polyethylene cushioning is made of two or more sheets of plastic film. The material is usually transparent and heat sealable.
- L Urethane or polyethylene foam comes in foam slabs that can be slit, die-cut, hot-wire-cut, or sawed to obtain a desired shape.
- M Self forming, foamed, plastic cushioning (foamed polyurethane) can be "foamed in place" by a very simple process as shown below.



"Foaming in place."

(Courtesy, Instapack Corp.)

- N Vermiculite is a highly absorbent material, and is useful in packaging liquids.

0 Rubberized Bound Fiber. Fiber material bound with an elastic material.

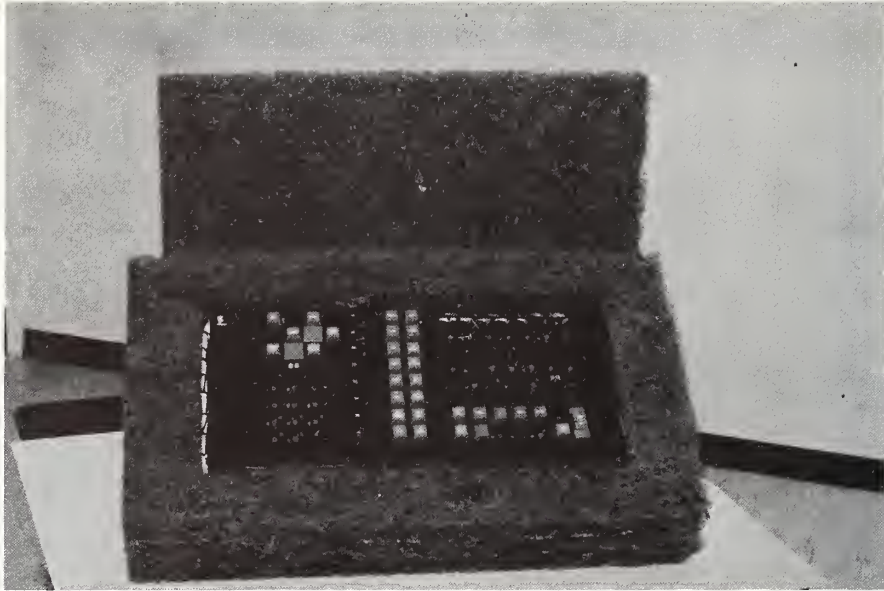

Rubberized Hair

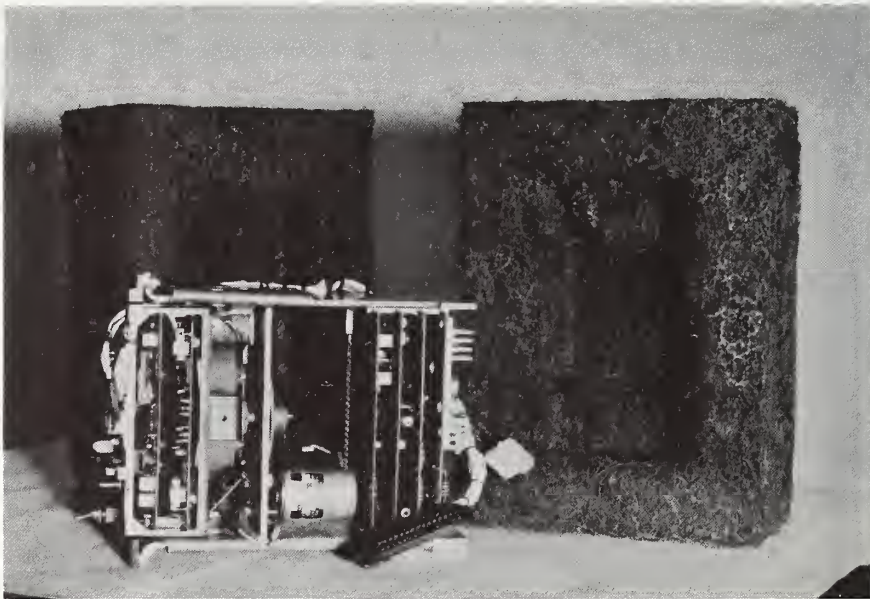

Rubberized Hair

(Courtesy, Blocksom and Co.)

P Sealed plastic internal container.



(Courtesy, Protective Lining Corp.)

C.3 CLOSURES

This section includes short descriptions of closures referred to within the Guidelines Table. The letter in the box to the left of each description corresponds to the codes used in the Table. For further information see Chapter 4.

a Adhesives

1. PASTE
2. GLUE
3. CEMENT
4. THERMOPLASTIC

b Paper Tapes. These tapes have a pressure sensitive or water activated gummed adhesive. Tapes come in different widths and strengths. However, the 60 lb. kraft paper tape is the minimum strength recommended and the width normally should be at least two inches. Paper tapes should not be used on heavy, dense parcels. Six strips of tape to form an "H" are necessary to close a regular slotted container as shown below.

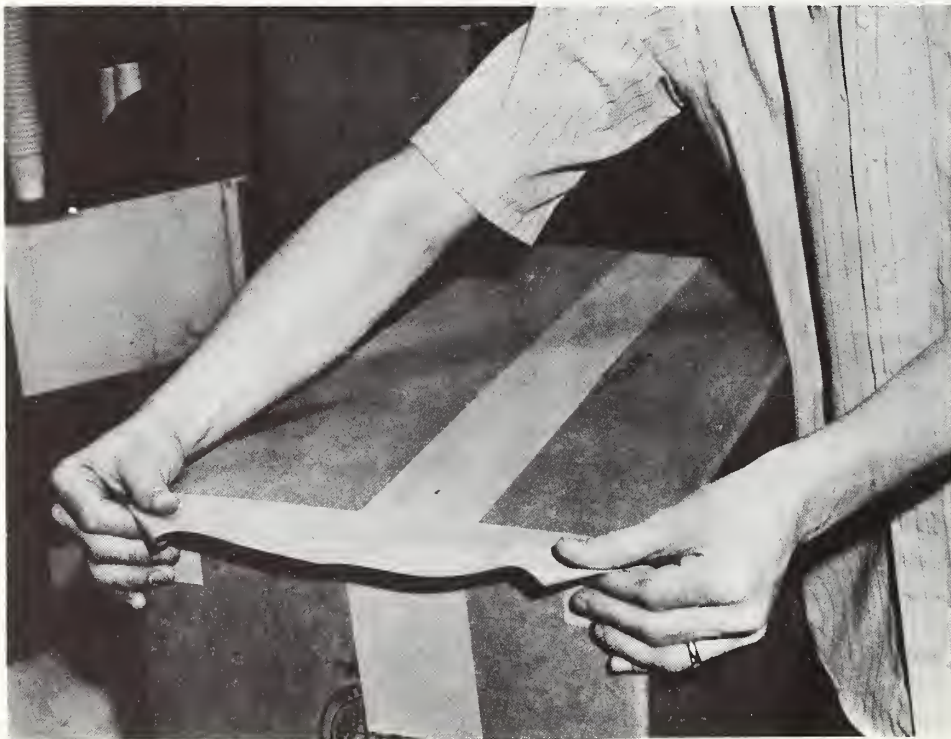

. Use of 60 lb. kraft paper tape.

(Courtesy, 3 M Co.)

c Reinforced Gummed Tapes. These tapes consist of a rolled or laminated paper structure with glass, rayon, or polyester fibers embedded throughout. Three different reinforcement patterns are shown below.

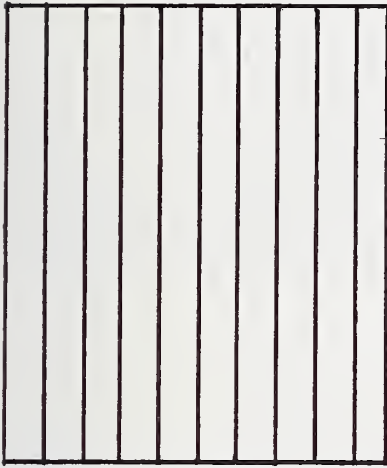

Lengthwise

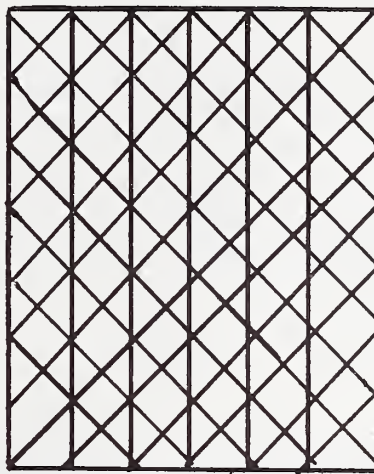

Combination

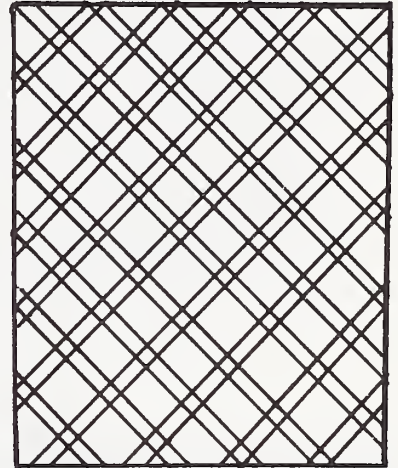

Bi-Diagonal

(NBS)

It should be noted that the "Lengthwise" reinforced gummed tape does not have added crosswise strength.

To apply reinforced tapes, use a wetting brush and recommended wetting agent. Firmly apply to box allowing the tape to extend three inches over the adjacent side of the box.

Only two strips of tapes are necessary when used as shown below.

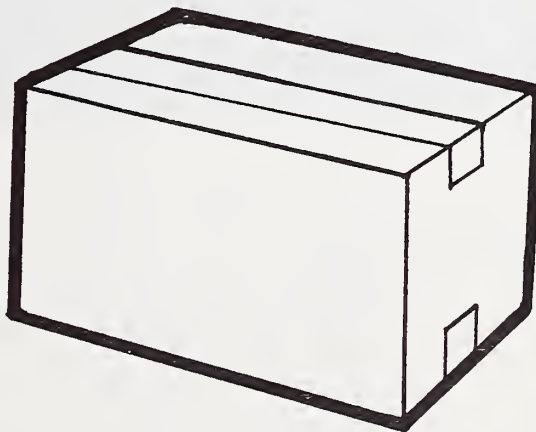

(NBS)

Pressure Sensitive Plastic Closing Tapes

Widely used for fiberboard box closure. These tapes are often applied automatically by machine. Polyester plastic-backed tapes are preferred because of high strength, toughness and tear resistance in both directions.

- d Pressure Sensitive Filament Tape. This tape is sticky at room temperature. It is composed of filaments of glass, rayon or polyester embedded in a pressure-sensitive adhesive material. It is extremely strong, and even short strips will effectively close a container. Tensile strength, tear resistance and adhesive characteristics must be as described in Chapter 4. One type of tape clip used for reinforcement is depicted below. See Chapter 4 for filament tape applications on containers.

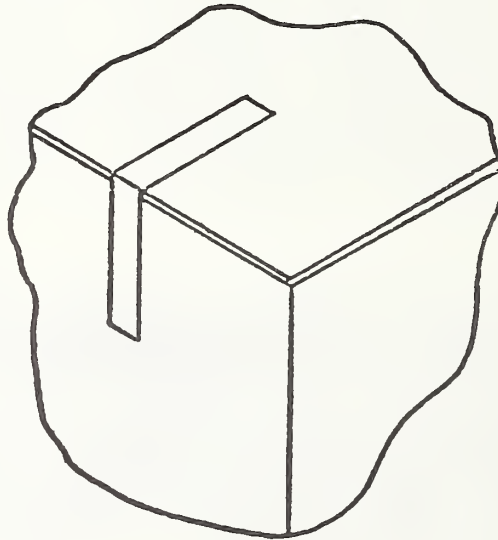

(NBS)

Typical pressure sensitive filament tape "L"-clip

- e Stitching: fastening by means of a short piece of wire formed from a continuous coil at the moment of use.

f Stapling: fastening by a piece of preformed metal wire dispensed from a magazine-fed machine.

The usual light-weight office stapler is unsuitable for closing parcels, because the staples are too small and too weak. In closing a parcel, the stitch or staple is first driven through the flaps of the container and the legs are then bent inward and upward against the bottom of the flap. The legs must be securely "clinched" so that there are no protruding sharp edges or points.



(Courtesy, Jiffy Manufacturing Co.)

Closing and stapling a cushioned bag.

- g Locking Tab. The flaps of a closure cut in such a way that two ends interlock with each other.
- h Cuffs. Extensions on the ends of mailing tubes that are tucked inside after the contents have been inserted.
- i Metal Clips. Typically used to secure lids, cans, or similar containers as shown below.



(Courtesy, Grief Brothers Inc.)

Fiber drum with metal slipcover and metal slip closure.

- j Plastic or Metal Banding. Typically used to reinforce the closures of heavy containers. Loose banding can be dangerous to employees, to Postal equipment, and to the person receiving your parcel. On specially designed containers, banding may be used as the primary means of closing. Because banding is often loosened by compression on the container; it should not under normal circumstances be relied upon as the only means of closure.

CHAPTER 3

FACTORS INFLUENCING PACKAGING

A. INTRODUCTION

Many factors must be considered when preparing a package for mailing. Packaging for Parcel Post depends not only on the particular item being mailed, but also on the things that could happen to the parcel as it travels through the Parcel Post system. This chapter is intended to make the mailer aware of the factors that should be taken into account when preparing packages for mailing.

These factors fall into three general groups:

- Characteristics of the Product--including such things as the value of the item to the mailer and the receiver; the size, structure, and shape of the product; and the ability of the product to withstand mechanical shock and vibration.
- Parcel Post Environmental Influences--including the temperature and relative humidity levels that can be expected in the mailstream; the kinds of handling the parcel may receive; and the kinds of forces and vibrations that can be expected.
- Other Frequently Neglected Factors--including whether an item can be mailed or can be mailed only under special conditions; cautions about certain items such as liquids, magnets, fabrics, and books; and need for extra care when preparing parcels of unusual sizes and weights.

All these factors and many others are discussed in this Chapter.

B. CHARACTERISTICS OF THE PRODUCT

Although most mailers are aware of some of the product characteristics which effect packaging, (such as shape, size and weight), there are other aspects which are also important. The most important point, however, is for the mailer to know these characteristics in selecting the right materials and ways of packaging.

B.1 PRODUCT "VALUE" AND PACKAGING/MAILING COSTS

The value of a parcel is usually considered by the mailer to be the cost of the item mailed plus, perhaps, the cost of the packaging and the mailing fees. In many cases, however, the true value cannot be determined or measured in dollars and cents alone. Since the value of the item being mailed must be compared with the mailing costs, it is very important to think about complete product value:

Value factors

- Replacement cost, in most cases, is the amount of money and time it would take to replace the item if it were lost or damaged. Some rare or one-of-a-kind items such as collector's items, family heirlooms, and art objects are not replaceable. Such items may have more "value" than their dollar and cents cost.
- The value of time, while not easily measured in money, can also be important to the mailer and the receiver. If a shipment is delayed because of an illegible address or damaged in the mail system because of poor packaging, each extra day the package spends on its journey may cost money. Parts lost in shipment or found to be damaged on arrival due to poor packaging or labelling have been known to stop assembly lines, throw repair shops off schedule, or cause other businesses to lose money.



(NBS)

Figure 3. Inadequately packaged parcels at a Parcel Post re-wrapping station. (Some of the contents of these parcels have been lost.)

- First impressions are made by the package. A parcel delivered to the addressee in good condition tells that the addressee's satisfaction and approval is valued enough by the mailer for the product to be carefully packaged and properly addressed. Products which have been damaged because of poor packaging or careless packaging may discourage the receiver from ordering any more products from the mailer. A poor appearing parcel, whether damaged or not, may cause the receiver to think that the quality of the product itself is poor.

The value of the product may be the most important factor when the mailer decides how much he is willing to spend in time, money, and effort to package his product. In other cases, such as when some or all of the packaging materials are going to be used again, the value of such reuse should be considered. In other cases, the costs of the packaging materials and the time and effort put into the packaging are compared to the value of the item being mailed. For the mailer, either too little or too much packaging is undesirable. This Handbook is intended to help the mailer find the right packaging materials and techniques.

Cost Factors

To compare product (and packaging) values with costs, the mailer needs to be aware of the cost factors listed below.

- Postage. Postage is determined by the "gross" weight of the parcel and the distance it travels in the mail. Gross weight is the weight of the goods being mailed ('net' weight) plus the weight of the packaging materials and container ("tare"). In some cases, the cost of mailing the container and packaging is greater than the value of the contents. The mailer should, therefore, try to select the lightest weight packaging that will do the job.
- Cost of Labor. For mailers who send large numbers of parcels, the wages of the people who package the products may be a big cost factor. Cheap materials may no longer be low in cost if they require extra time and effort to use. Total costs may be lowered by choosing somewhat more expensive packaging materials that are easier to use. Such large mailers should find out the best combination of packaging costs and labor costs by preparing a sample of parcels before buying a large stock of packaging materials.
- Cost of Packaging Materials. There are many different packaging materials and containers on the market and there can be considerable differences in their costs. Many different

packaging materials can give equivalent protection to the product, if used properly. By learning about packaging materials, the mailer may be able to choose lower cost packaging materials and still package his product properly.

There are some other points to consider when the sender is thinking of packaging costs:

- Buying large quantities of packaging materials at the same time may help reduce costs.
- The cost of storing and handling large quantities of packaging materials will depend on the kinds of materials bought (the amount of space they take up while being stored, whether they burn readily or catch fire easily, how easily they can be moved). Insurance rates may also be a factor.
- Some packaging materials and containers can be used more than once. In general, however, unless a container is specifically designed to be reused, it cannot be expected to stand more than one shipment without changing either the contents, the packaging materials or the method of packaging. Even when employing containers specifically designed for reuse, the mailer must be careful to allow for normal wear and tear and discard if puncturing, tearing, wetting, or general loss of strength occurs. Field surveys and laboratory tests show a much higher failure rate for reused containers which were not designed for reuse than for new containers.
- Use of packaging materials made from recycled material may help reduce costs.
- A mailer may also be able to reduce his packaging costs by recycling his own packaging materials when they are no longer useful for shipping.

This section has discussed product value as it may be related to overall packaging costs. Packaging costs also depend on other product characteristics which are discussed in the following sections.

B.2 DENSITY OF CONTENTS AND PARCEL

The density of a product (defined as the weight per unit volume) is important in packaging because the density of a product determines the force the product will exert against the sides of its own container. The shipping container must be able to withstand both the forces caused by the product within as well as those from other things outside the parcel.

A metal cube (made of lead, for example) is said to be of higher density than a box of cotton, because if each one weighs one pound (.453 kg), the lead will take up less space than the cotton. The higher density product, lead, exerts a greater force per unit area on each side of its container than the lower density product, cotton. A high density item, if properly packaged, may help support package sides; but if improperly packaged, it is more likely to damage the package from within than is a low density item. The low density item is less likely to cause package damage from within, but probably will not help support and/or reinforce the sides of the container.



(NBS)

Figure 4. Container broken by forces from its own contents.

High density products and low density products may require different packaging in order to take advantage of their "good" properties and to help make up for their "bad" properties. Both high density and low density products need internal packaging, but for different reasons. Internal packaging or cushioning may prevent the high density product from tearing open its own container walls. Low density products may need cushioning, supporting materials, or stronger containers to resist punctures or crushing from other parcels in the mailstream.

B.3 STRUCTURE AND SHAPE OF PARCEL AND CONTENTS

The structure and shape of a product have a much greater effect on its packaging than is generally realized. Products which are regular in shape and have good structural strength may be much easier to package than products which have irregular shapes or structural weaknesses. For items with regular shape and adequate structural strength, packaging may be as simple as using a container of the proper size. Irregularly shaped products may need extra cushioning and/or supporting materials to make the product fit shipping containers (which usually have regular shapes). In addition, over 90% of the containers in the Parcel Post mailstream are made of paper, paper composites, or paper-related items. Paper containers need internal support, either from the product itself or from additional packaging materials, to give good service in the mailstream. Products with structural weaknesses usually need extra supporting materials inside the container. (Materials and methods of cushioning are discussed in Chapter 4.)

Regardless of the shape and structure of the product, it is better if the packaged product (the parcel) is of regular shape. Parcels of regular shape have surfaces which are more likely to rest easily among other items when packages are stacked or when they bump into others on conveyor belts and in chutes. Regularly shaped parcels may also help to spread compressive and vibrational forces over larger areas and to reduce the possibility of damage to themselves. (See Section D of this chapter.)

B.4 FRAGILITY

Something that is fragile is usually thought of as being easily broken, damaged, or destroyed. "Fragility" is the general term used to talk about the ability of a parcel (the product and its packaging) to withstand the forces it meets in the mailstream. There are two important points for the mailer to keep in mind about fragility:

- (1) The mailer must think of the fragility of the parcel and not just the product. Packaging is a means of protecting the product. If the packaging is damaged it may no longer be able to do its job.

- (2) There are many ways in which a parcel can be damaged other than from dropping.
- Another package can be dropped on it. When this happens, the airtight parcel which receives the blow can burst. (This is the same physical principle as the trick of blowing up a paper bag, sealing off its top by twisting, and then hitting the bag causing it to "pop".)
 - A package may be crushed if it cannot support the weight of other packages piled on top of it. The contents may be damaged when the parcel is crushed or lost later as the package continues its journey.
 - Containers may be damaged by the movement of loose objects inside. If the outer wall of the package is torn or punctured by inside pressures, some of the contents may fall out, dirt and dust may get into the package, and the whole unit ends up in generally weakened condition.
 - Vehicles in (or on) which parcels are carried produce vibration. Such vibration, if sustained, may cause damage to the package or its contents if the rate of the vibration happens to match the natural frequencies of the product or the package. (Vibration is discussed further below.)

The exact cause of damage to a parcel is often difficult to pinpoint. Any one or all of the possibilities listed above may contribute. The careful mailer of parcels should consider all of those possibilities when preparing a package for mailing.



(NBS)

Figure 5. Properly packaged, "extremely fragile" merchandise is holding its own in the mailstream.

TESTING FOR FRAGILITY

The large mailer may do well to actually test the fragility of his parcels. There are two tests which can be used: (1) damage boundary tests and (2) tests for natural vibrating frequencies (both discussed below). Essentially, these two tests will tell the mailer how well his products and parcels can withstand various drops, falls, bumps, bounces, and vibrations. The mailer can then compare the test scores with the kinds of drops, vibrations, etc. found in the mailstream, and tell what sort of packaging is needed to give adequate protection for his products. This means that the mailer must be willing to damage a few of his own products to insure that his customers receive undamaged goods.

Fragility testing will usually require a series of such tests. The product may first be tested by itself. Then, after suitable packaging is selected, the packaged product will be tested. Sometimes several different package/product combinations will be tested before the "right" one is found.

Sections B.4.1 and B.4.2 discuss damage boundary tests and tests for natural vibrating frequencies.

B.4.1 Damage Boundary Tests

Damage boundary tests are used to determine how well a product or parcel can withstand drops, falls, and bounces. The important fact to remember is that damage boundaries for an item depend on the heights from which the object is dropped and the surfaces it hits. The distance an item falls determines its speed (velocity). The surface it hits, depending on its hardness or "give", determines how quickly the object loses its speed and how much it bounces. A mailer can find the damage boundary for any item by testing its resistance to changes in velocity and by testing its resistance to different levels of acceleration. Every object has a critical velocity change boundary and a critical acceleration boundary. If either of these is exceeded, the object will be damaged.

- Critical Velocity Change. In a drop situation, the greater the distance an item falls, the faster it moves (the higher its velocity). When it hits a surface, it stops, and its velocity changes to zero for an instant. The amount of velocity change in this situation is the difference between the speed at which the item was moving the instant before it hit and the speed it was moving at the instant it hit:

$$\text{Impact Velocity Change} = (\text{Velocity Before Impact}) - (\text{Velocity At Impact})$$

And since the velocity becomes zero for an instant when the object hits the surface;

$$\text{Impact Velocity Change} = (\text{Velocity Before Impact}) - 0$$

Therefore;

$$\text{Impact Velocity Change} = \text{Velocity Before Impact.}$$

All objects bounce when they hit a surface. To find the total velocity change, the initial velocity of the bounce must be added to the velocity change on impact. Therefore,

$$\text{Velocity Change} = \text{Velocity Before Impact} + \text{Bounce Velocity.}$$

The velocity of the bounce must be added to the impact velocity, because occasionally the velocity of the bounce is almost as large as the impact velocity. (The bounce velocity is usually 20-90% of the impact velocity.)

Using drop heights and surfaces generally found in the mail-stream the mailer can find what velocity change boundary is critical for his parcel. That is, velocity changes lower than the critical velocity change boundary will not cause damage to the merchandise, regardless of the levels of acceleration (described below). If the product is likely to undergo velocity changes that are equal to or greater than its critical velocity change, the mailer must be certain that the packaging keeps the product from reaching its critical acceleration.

- Critical Acceleration is the second factor in damage boundary testing. Acceleration is the rate of increase in velocity per unit time. Force caused by acceleration is expressed in "g" units.* (One "g" is the force caused by gravity, which is 386.4 inches per second per second.) Simply stated, one "g" is a force equal to the weight of the object. All objects at rest are subjected to a force equal to their own weight. If an object undergoes a force of 50 "g"s, it is subjected to a force equal to 50 times its own weight.

A strong, solid object in a corrugated fibreboard box which is dropped onto a concrete floor will receive a shock (peak acceleration) of 300-800 "g"s. If the same parcel hits another box containing soft material instead of the concrete floor, it will have

* Forces caused by acceleration are expressed in "newtons" in the metric system.

a peak acceleration of only about 50 "g"s. (It is important to note, however, that in these examples, the 300-800 "g" force would only last 2-3 thousandths of a second while the 50 "g" force would last 20-30 thousandths of a second. The duration of the force of acceleration is important because it affects the change in velocity of the object--the amount it will bounce.)

The critical acceleration boundary for an object is the greatest impact (peak acceleration) the item can withstand without damage.

Damage boundary, then, is a combination of critical velocity change and critical acceleration. Both of these factors can be determined by testing items to be mailed, using drop heights and surfaces found in the Parcel Post system. Figure 6 shows damage boundaries for a portable TV set. This figure shows, for example, that if the TV is likely to undergo a velocity change of more than 100 inches per second, it must be packaged so that its peak acceleration will be no greater than 75 "g"s. (A velocity change of 100 inches per second could be produced, for example, by a free fall as short as 9 inches with only a 20% bounce velocity).

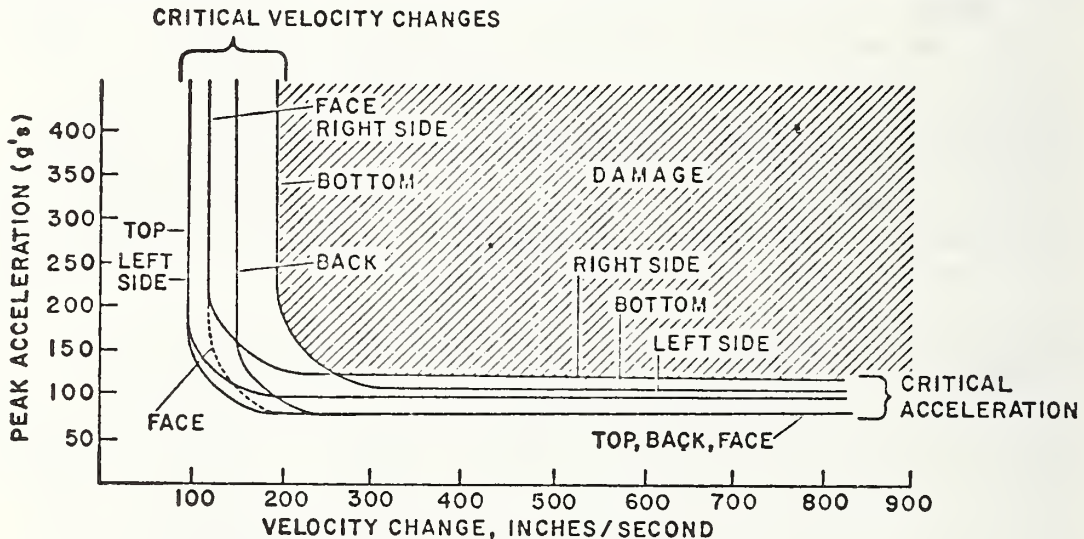

FIGURE - COMPOSITE DAMAGE BOUNDARIES FOR A
(Courtesy, Michigan State University School of Packaging)

Figure 6. Damage boundaries for the six sides of a portable television set.

There is one other important point to note about damage boundaries: A falling parcel may land in any position. Damage boundary tests should be done for several landing positions (such as each flat surface, corners, and edges) to be certain that any weak areas of the parcel or product are tested. Figure 6, above, shows damage boundaries for all six sides of a portable TV.

Damage boundaries are used to choose proper packaging materials and methods. Once the parcel is in the mail, the mailer cannot affect the heights from which it is dropped or the surfaces it hits. Only adequate packaging can insure a safe journey through the Parcel Post system. (Packaging materials are discussed in Chapter 4.)

B.4.2 Vibration

The second factor involved in testing fragility is vibration. All objects have natural frequencies of vibration. That is, for every object, there are frequencies at which the object or its parts vibrate naturally (resonate). If the natural frequencies of the merchandise (resonating frequencies) happen to be the same as the frequencies produced in the mailstream by conveyors, trucks, wagons, etc., serious damage can result. If the mailer knows the natural frequencies of vibration, he can design packages or use packaging materials to prevent such damage.

To find these frequencies, the object should be fastened to a vibrating table and the frequency gradually increased from about 1 hertz* to about 500 hertz. (See Table 2, page 69.) The frequencies at which the object or its parts move or shake violently are the natural vibrating frequencies.

If the product's natural vibrating frequencies are ones that will be found in the mailstream, the mailer can prevent damage in one of two ways:

- If only certain parts of the product will be affected by the frequencies in the mailstream, the mailer can use simple methods of blocking or fastening these parts to some other part of his product. This will usually either increase the natural frequencies of the parts to higher frequencies not found in the mailstream, or limit their movement to an acceptable range.
- If the product or the vibrating components cannot be blocked or fastened, the mailer must package his product in such a manner that the energy in the vibrations will be absorbed by the packaging materials. The vibration of the product will then be reduced.

B.4.3 Research in Fragility Testing

Research to find out the best way of testing the damage boundaries for parcels is now being carried out for the U.S. Postal Service. The tests use shock machines and vibrating tables to produce forces like those found in the mailstream. The tests developed in this program will be available for use by mailers to test new, and possibly lower cost, packaging materials or methods before actual use in mailing. These research results will be published in the near future. In spite of all sorts of laboratory testing, however, the final test must always be to send a sample of parcels through the mail and check the condition of container and contents after arrival at the destination.

* One "hertz" is equal to 1 cycle per second.

C. OTHER FREQUENTLY NEGLECTED FACTORS

This section discusses some common factors which are often neglected by the mailer when packaging items to be sent through the Parcel Post system. The most important point presented here is that the mailer must be aware of his responsibility for preparing "good" parcels. Proper packaging, in addition to protecting the mailer's product, prevents damage to other mail, postal equipment, or postal employees.

C.1 RESPONSIBILITY OF THE MAILER

The mailer is responsible for the proper packaging of the goods he or she sends through the Parcel Post system. While this may appear to be an obvious statement, its meaning must be explored a little further. The mailer must:

- Know or find out whether the item can be mailed. (See Mailability and Nonmailable Matter, below.)
- Be aware of the things that are likely to happen to the parcel as it makes its journey (temperatures, humidity levels, handling methods, transportation, time to reach its destination, etc.) and take those things into account when packaging. (Section D of this chapter discusses Parcel Post Environmental Influences.)
- Prepare a parcel that is capable of reaching its destination without damage:
 - to itself,
 - to other parcels in the mailstream,
 - to postal employees, or
 - to postal equipment.

Postal employees are, of course, available and willing to answer questions from Parcel Post customers, but the mailer must know which questions to ask. The mailer must be aware of his packaging responsibility.

The local postmaster or his representative can refuse to take a mailer's parcel if it is not properly packaged. If a parcel is accepted but causes problems later in the mailstream, it can be removed at any point and the mailer can be requested to pick it up there. Sometimes parcels with questionable packaging are accepted, but the Postal Service may still file a Packaging Improvement Report which advises the mailer on how the packaging may be improved.

In many cases, postmasters and customer service representatives will be able to answer a mailer's special questions. If a large mailer has any doubt about whether his parcels can get through the Parcel Post system in good condition, however, the best test is to mail a sample of parcels and check their condition on arrival at their destination. The mailer can arrange for such preshipment testing with the local postmaster or Customer Service Representative.

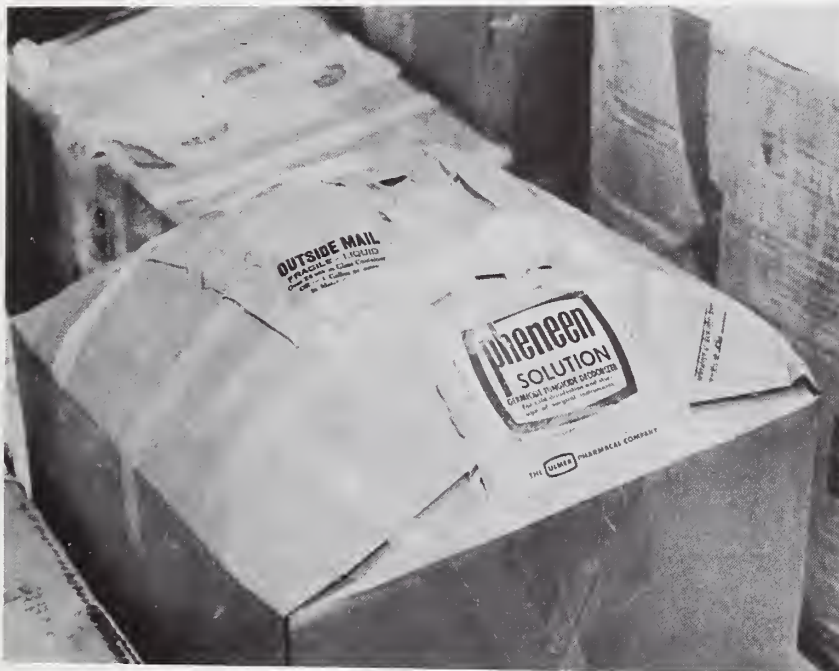

Figure 7. Inadequately packaged parcel being held for reclaiming by the mailer. (NBS)

The paragraphs below discuss some of the items often forgotten by the mailer. Every mailer needs to know about these in order to live up to his responsibility for proper packaging.

C.2 WHAT CAN AND CANNOT BE MAILED?

People who knowingly mail (or cause to be mailed) any matter which has been declared to be nonmailable by Federal, State, or local law, can be fined or imprisoned or both for such an act. It is the mailer's responsibility to conform to any laws that apply to items he mails. There are three general categories of mailability: Mailable matter, nonmailable matter, and matter which can only be mailed under special rules.

C.2.1 Mailable Matter (Domestic Service Only).

In general, anything can be mailed from one place to another within the United States:

- Unless it is prohibited from being mailed by law, regulation, or treaty; or
- Unless the parcel does not meet postal regulations for such reasons as unacceptable size or weight, insufficient postage, inadequate address and bad packaging.

C.2.2 Nonmailable Matter: General

Matter which is prohibited by law from being sent through the mails may be divided into two broad categories:

- (1) Harmful matter--(discussed below), and
- (2) Objectionable matter--Anything which may be considered objectionable by the receiver because it is threatening, libelous, defamatory, scurrilous, filthy, lewd, or primarily sexual in nature. Since objectionable matter is not usually a packaging problem, it will not be discussed further in this Handbook. Additional information can be obtained from the local postmaster.

C.2.3 Nonmailable Matter: Harmful Matter

Harmful matter may be roughly described as anything that may be dangerous or damaging to life, health, or property under normal conditions in the Parcel Post system. In general, things that can cause explosions, fire, caustic reactions, or oxidizing reactions; things that can spread or cause disease to human, animal, or plant life; and things that can decay rapidly and give off obnoxious odors are considered "harmful matter" under the law. If the mailer has any doubt as to whether his item is legally mailable, he should contact the local postmaster or Customer Service Representative.

Some examples of harmful and, therefore, nonmailable items are listed below. Some of these items are mailable under certain special rules discussed in the next section, but in general, these items are prohibited by law from being put into the mailstream:

- Perishables such as food, game, live animals, or other goods which may die, spoil, or rot in the amount of time it takes to reach the addressee.

- Explosives such as gun powder, firecrackers, ammunition or tear gas.
- Flammable liquids and some combustible liquids which can be ignited by spark, friction, heat, or spontaneous physical or chemical change. Lighter fluid, antifreeze solutions, some cleaning fluids, and paint thinners are in this category.
- Corrosive liquids (acids and alkalides) such as liquid drain cleaner or liquid boiler compound which, if they leak, can
 - damage living tissue;
 - damage property;
 - cause fire upon contact with commonly found matter; or
 - produce toxic, corrosive, or irritating gases.
- Flammable solids which can be ignited by friction, absorption of moisture, or spontaneous chemical changes. Such things as railway or highway flares and fuses, ammonium nitrate fertilizer, and "strike anywhere" matches are in this category.
- Flammable gases and some nonflammable compressed gases which are toxic or irritating. Liquid propane gas (LPG) and carbon dioxide (CO₂) cartridges are examples.
- Poisons or substances containing poison including
 - all poisonous animals, insects, and reptiles
 - all snakes
 - many fertilizers
 - some drugs, medicines, cosmetics.
- Controlled substances such as narcotics.
- Quarantined matter as defined by the U.S. Department of Agriculture.
- Infectious matter as defined by the U.S. Department of Health, Education and Welfare.
- Any device or machine which, on its own, could be dangerous to life, health, or property. Loaded guns or battery operated devices with the batteries in place are in this category.
- "Special legals" such as handguns, switch blade knives, and motor vehicle master keys.

Again, if the mailer has any doubt about whether his product is mailable or nonmailable, he should contact the local postmaster or Customer Service Representative. Some nonmailable items can be sent through the Parcel Post system if the mailer follows special rules.

C.2.4 Articles Mailable Under Special Rules

Some harmful items are allowed to be mailed if (1) the mailer follows special instructions which make the item safe in the mailstream, and (2) if the U.S. Postal Service authorizes that those special rules have been followed. The mailer, however, is responsible for following all rules, laws, or regulations that apply to the item being mailed.

There are several general ways that a harmful item may be made acceptable for the mails. There are many specific rules for nonmailables, but these rules fall into three general categories:

- Certain harmful items can only be mailed from and/or to certain specified people or organizations. For example, unloaded handguns can be mailed from licensed manufacturers and dealers to authorized officials such as law enforcement personnel, and vice versa. In a case such as this, the mailer must file a statement with the local postmaster at the time of the mailing, and the postmaster must give his consent in writing.
- Some harmful items may only be mailed if they are properly marked or labeled. The rule might specify; for example, that
 - The contents must be plainly identified on the outside of the parcel;
 - The full name and address of both the mailer and the addressee must be on the outside of the parcel; and
 - Any label which is required by law must also be on the outside of the parcel.
- There may be specific packaging requirements. The kind of packaging required depends on the nature of the harmful matter. In general, the rules on packaging have to do with such things as
 - The proper internal container for the harmful matter;
 - Limits placed on the volume or weight allowed for either the internal or outer container;
 - Limits placed on the kinds of items that can be mailed in any one container;
 - Specific requirements for internal packaging that will cushion, support, and/or absorb the contents; and
 - Specific requirements for the outer container.

Listed below are several nonmailable items which can sometimes be mailed under special rules. The mailer should always see his local postmaster before mailing such items. Some of the special mailing rules change frequently.

Animals (Alive or Dead)
Biological Products
Chemicals
Controlled Substances (Narcotics)
Compressed Gases & Containers
Disease Germs
Explosives
Firearms
Flammable Liquids
Flammable Solids
Furs/Hides/Skins/Pelts
Insects
Intoxicating Liquors
Liquids

Matter with Obnoxious Odors
Motor Vehicle Master Keys
Oxidizing Materials
Perishables
Plant Quarantines
Poisons
Poisonous Drugs and Medicines
Poultry
Powders
Radioactive Material
Reptiles
Safety Matches
Sharp Objects and Knives
Snakes
Scorpions



Figure 8. Honeybees and chicks (packaged according to special rules) in the mailstream.

(NBS)

C.3 MAILING NONFLAMMABLE LIQUIDS*

Liquids are among the products which can only be mailed if special rules are followed. Packaging for nonflammable liquids is treated separately here, because liquids are fairly common in the Parcel Post mailstream and because many mailers appear to be unaware of the need for special packaging when mailing liquids.

As was discussed in Section C.1, the mailer is responsible for packaging his product so that it can reach its destination without being damaged and without damaging other parcels, postal equipment, or postal employees. Because any liquid that spills or leaks in the mailstream can damage other mail and postal equipment, all liquids should be packaged as if they were harmful matter.

Certain kinds of finely ground or pulverized substances must also be packaged, in general, as though they were liquids. Any matter that can sift out or leak from a container or that can "run" if moistened should be treated as a liquid when it is being packaged. Many powders, flakes, crystals, granules, pastes, and salves fall into this category.

Below are the most important, and most often neglected, factors a mailer must take into account when preparing liquids and finely ground substances for shipment. (See Chapter 4 for methods and materials.)

- The INTERNAL CONTAINER which holds the liquid (product container):

- Capacity and Breakability of product containers. Breakable containers that hold more than one quart have an exceptionally high breakage rate in the Parcel Post system. There are packaging rules that must be followed for breakable containers for liquids, and these rules vary according to the size of the product container.

Nonbreakable product containers for holding liquids (such as steel pails, solid fiber drums, and plastic drums) can be mailed without external shipping containers if they meet capacity requirements and other packaging requirements.

- Air space. Proper amounts of air space must be left in liquid product containers to allow for the expansion and contraction of the liquids (or their vapors) as they experience temperature changes in the postal system. (See Section D for temperatures found in the mailstream). Product containers must never be completely filled with liquid.

* There are additional restrictions and packaging requirements for flammable, combustible, and corrosive liquids which are not discussed here. See the local postmaster for more information.

- Caps, Lids, and Tops. Tops used when mailing liquids must have some sort of positive lock or seal (such as solder, metal overseal, clips, wire, or pressure sensitive material with heat-shrink properties.) Friction tops such as cork stoppers and pry-up lids are not, by themselves, adequate for mailing.



Figure 9. Damaged parcel containing one-gallon can of chocolate syrup. The can had a pry-up lid without a positive mechanical lock. (NBS)

- INTERNAL PACKAGING for liquid product containers is the most common source of problems with parcels containing liquids.
 - Isolation of product containers. Breakable or easily opened product containers must be packaged so that they are isolated or separated from the walls of the shipping container and from any other product containers in the parcel. Proper isolation keeps forces and vibrations in the mailstream from being directly transmitted to liquid product containers, keeps product containers from moving and transmitting forces, and generally strengthens the parcel.
 - Containing and/or absorbing leaks and spills. Product containers for liquids must be packaged so that any leaks or spills that occur will not damage the shipping container or

leak out into the mailstream causing possible injuries to Postal employees, other mail and processing equipment. Either the inner walls of the shipping container must be treated to retain the liquid contents, or the product containers must be sealed in a material that will retain the liquid, or both. In addition, sufficient nonreactive, nonflammable absorbent material must be present to absorb the liquid if leaks or spills should occur.



(Courtesy, Dow Chemical Co.)

Figure 10. Liquid in glass containers being packaged. (Note the isolation of product containers and the absorbent packaging materials.)

- SHIPPING CONTAINERS for liquids are specified in postal regulations according to the capacity of the product container, the number of product containers, and the weight of the contents. Breakable product containers for liquids must be mailed in shipping containers with rigid construction (such as wood, corrugated fiberboard, metal, or plastic).
- LABELS are required for all parcels containing liquids. These special markings must generally describe the contents, such as "Liquids", "Glass", or "Liquids in Glass".

C.4 MAILING SOME "PROBLEM" PRODUCTS

Some very common products have been identified as 'problem' items in the Parcel Post system. That is, some products need extra care in packaging if they are to reach their destination without being damaged or causing damage. Four such items are discussed below.

- Magnetic Tapes should always be packaged in metal (ferrous) containers. Such tapes need to be shielded from any unusual magnetic fields that might exist in the mailstream. If magnetic tapes are not shielded, erasures and print-throughs can occur.
- Magnets should always be packaged in pairs, with their opposite poles in contact. That is, each pair of magnets should "stick" together by their own magnetic force.
- Fabrics present an unusual problem when they are mailed in any container that is not rigid. When a corrugated container filled with fabrics is struck by a heavier, denser parcel, the airtight sealed container of fabrics can "explode". Fabric containers should have vents or holes which let air escape from the container thus preventing such "explosions".

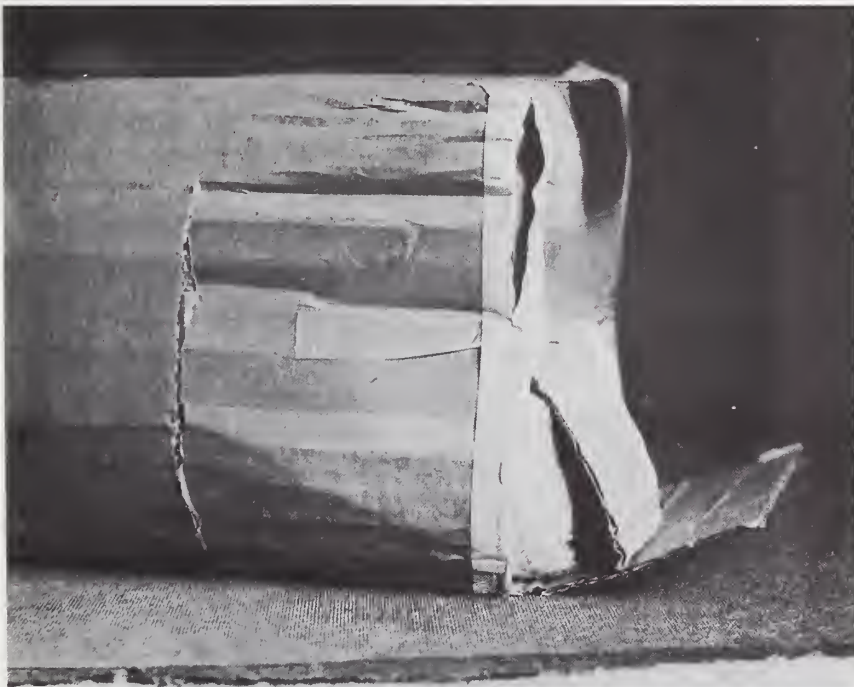

(NBS)

Figure 11. An exploded external container.

Air trapped inside exerted sufficient pressure to break open the external container.

- Books and Documents must always be securely tied or banded together before being placed in a container. When not bound internally, books and documents (which are very dense items) can damage or destroy their containers from within.



(NBS)

Figure 12. Damaged parcel containing documents NOT internally bound.



(NBS)

Figure 13. Damaged parcel containing books NOT internally bound.

- Unpackaged Products are sometimes accepted in the Parcel Post system. It is always better for products to be packaged so that they "ride" better in the mailstream, but some virtually unbreakable products such as trailer hitches, automobile mufflers, and tailpipes can be mailed without external containers. Articles with sharp edges, burrs, welds, or points, however, must still be packaged so that they do not injure Postal employees or damage other mail. Mailing unpackaged products is not recommended.

C.5 SIZE AND WEIGHT OF PARCEL

The size and weight of a parcel, and the relationship of the size to the weight (density; see Section B.2) affect the handling and processing of the parcel in the Parcel Post system.

Maximum Allowable Size and Weight

Parcels to be mailed in the Parcel Post system may not exceed certain limits:

- Parcels mailed between two first class post offices shall not exceed 84 inches in combined length and girth; nor shall the maximum weight be more than 40 pounds.
- Parcels mailed from or to an office other than first class, or to any rural star route shall not exceed 100 inches combined length and girth, nor weigh more than 70 pounds.
- For fiber or paperboard mailing tubes and similar long packages, the length must not be greater than 10 times the girth. Three-sixteenths of an inch minimum wall thickness of durable material is recommended.

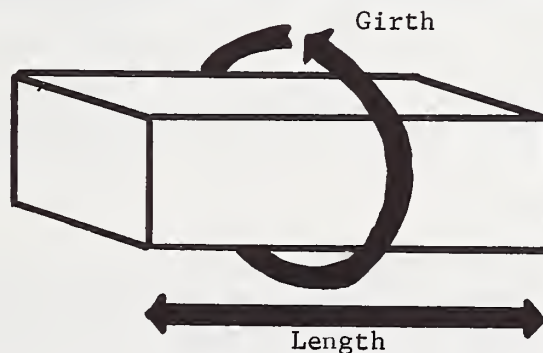

Large parcels (roughly, those greater than 24 inches in length) can sometimes cause problems even though they are within the allowable size limits. Such parcels usually cannot go through parcel sorting machines and other mechanized equipment. In addition, parcels longer than 24 inches tend to jam or "bridge" as they go around sharp turns in conveyor systems.

Parcels with very high, but allowable, length-to-girth ratios (roughly, those with lengths 5-to-10 times their girths) must be of very strong wall construction (3/16" or thicker) to avoid damage in the mailstream. The length and slenderness of such things as fishing rod containers and mailing tubes for blueprints make them susceptible to bending and breaking.

Large flat parcels are also susceptible to bending. If bending will damage the contents of such a parcel, extra internal packaging and/or a stronger shipping container may be required.



Figure 14. Large flat parcel entering the mailstream. Because of its size this parcel will be subjected to a great deal of stress in the mailstream.

(NBS)

Very Small Parcels

There are no minimum limits for sizes and weights of parcels. The mailer should be guided by "common sense", however, when mailing small objects. All parcels must be large enough for the mailer to be able to put legibly on one face:

- The return (mailer's) address
- The name and address of the receiver
- Proper postage markings

Small parcels often have addresses that are too small for easy reading, and they often lack proper internal packaging. When mailing a number of small objects to the same address, it is usually better to send them in one larger parcel (with proper internal packaging) than to mail them individually.

D. PARCEL POST ENVIRONMENTAL INFLUENCES

To package a parcel properly, the sender should have a general understanding of the environmental conditions a parcel can experience as it moves from sender to receiver through the mails.

D.1 GENERAL ENVIRONMENTAL INFLUENCES

The Parcel Post system is a U.S. Postal Service operation. The Postal Service operates about 35,000 separate post offices which range from small, one-man operations located in a corner of a country store to large multi-story buildings having a wide variety of processing equipment and employing thousands of postal workers.

Handling and processing differ considerably among post offices. One post office may handle and sort all parcels by hand; another may use mechanized equipment; and a third may use modern, semi-automated equipment. Each different way of handling and sorting may produce different environments.

In addition, post offices are connected by a complex transportation system which uses several different types of vehicles and many different transportation routes. Depending on its origin and destination points, a parcel can be carried on many different vehicles and be handled several times. In general, the farther a parcel must travel, the more handling it will receive.

There are some things in the Parcel Post environment which are the same for all postal facilities:

- One-Class Service. In general, once parcels are in the mail-stream, postal personnel and equipment do not distinguish among them or handle them differently.* Even though there are great differences among parcels in size, shape, density, container type, container material and contents, the most efficient method for handling, processing, and transporting large volumes of mixed parcels is one-class service.

As they are sorted, parcels are usually placed in sacks or hampers for the next stage of their journey. A parcel may be placed in a sack or hamper in any position (upside-down, on a corner and on end). Once inside a sack or hamper, a parcel loses its individual identity and all sacks or hampers are treated alike.

This "one-class" treatment is generally true for all handling, processing, and transporting within the Parcel Post system.



Figure 15. Display of parcels found in the Parcel Post system. (NBS)

- Responsibility for Parcels. The mailer is responsible for proper packaging, postage, and delivery to the post office. Once a parcel has been accepted into the Parcel Post system, either at the Parcel Post window or at the unloading dock, it becomes the

* Special Handling, an extra cost service, provides preferential handling where possible. Nonmachinable (see glossary) parcels which cannot be sent through mechanized equipment are usually taken out of the regular parcel mailstream at their first handling, but do not necessarily receive any special treatment.

responsibility of the U.S. Postal Service until it has been delivered to the addressee. (At the unloading dock, the mailer is responsible for unloading his own parcels and placing them on the dock in the presence of a receiving clerk.)

- Transportation in the Parcel Post system depends on three basic modes: Trucks, trains, and planes. A parcel may be carried in any one or all of these vehicles during its journey. Trucks, planes, and railroad cars are generally loaded and unloaded on a "first come" basis. That is, the mail that reaches the vehicle first is loaded first. Loose parcels may be placed among sacks of parcels or they may be stacked separately.



Figure 16. Truck being loaded for transit.
(Long parcels are loaded last.)

(NBS)

D.2 SHOCK/COMPRESSION/VIBRATION ENVIRONMENT

A typical handling and sorting system consists of such equipments as chutes, conveyor belts, slides, sack-shakeout areas, sorting machines, and loading and unloading areas. Parcels may undergo many changes in position as they go through the system. They are also bumping and being bumped by other parcels and the machinery. When they are stacked in hampers and vehicles, parcels experience compressive forces. The vehicles and other transporting machinery also produce vibrations.

- SHOCK refers to the bumps, drops, and bounces a parcel undergoes in the mails. (See Section B.4.1 for a discussion of velocity change and level of acceleration--Damage Boundaries.) In general, a parcel is likely to experience its most severe shocks during some part of handling or sorting rather than during transport.

Even though the Postal Service is continually improving its handling and processing system, parcels must still be expected to fall or be dropped as much as 2 feet during handling, sorting, loading and unloading. A single 2 foot drop onto a hard surface may produce a force of 200 "g"s (See Section B.4.1). After several such drops, the same parcel may experience forces up to 600 "g"s. To be safe, parcels should be packaged to withstand multiple drops of 2 feet without damage.

The shocks received by a parcel on trucks, planes, and trains are very small relative to those received in normal handling. The maximum force applied to a parcel in a 40 foot van which hits a rut in the road at a speed of 60 miles per hour would be about 25 "g"s. A parcel in a freight car receives a shock of only about 18 "g"s when a car is coupled at a speed of 9 miles per hour.

- COMPRESSION refers to the squeezing or pressing forces a parcel experiences when other parcels are placed on top of it or when other parcels press against it on conveyors or surge lines. Compressive forces on a parcel or sack are highly variable, depending on their position in a stack or on a conveyor.

Sacks tend to cushion and distribute compressive forces over a broad surface area. If, however, sacks are stacked 6 rows high (a common height in the Parcel Post system), inadequately packaged parcels in the bottom sack might be damaged by compression.

During handling and processing, parcels of very different sizes, weights, and densities may sometimes be intermixed. Regularly shaped parcels with proper internal packaging, and in proper shipping containers, however, are hardly ever damaged by compressive forces.

- VIBRATION in the mailstream is produced by such things as conveyors, mechanized sorting machines, trucks, planes, and trains. Some objects can be severely damaged if they are exposed to vibrations which are their natural vibrating (resonating) frequencies. (See Section B.4.2.) In general, special packaging is required when mailing objects which have natural vibrating frequencies between 1 and 500 hertz.

Table 2

Fundamental Frequencies Experienced by
Parcels in Transportation

Railroad	1-9, 50-100 Hz
Aircraft	
Piston	20-60 Hz
Jet	50-500 Hz
Truck	
Rough road	3-70 Hz
Smooth road	3-200 Hz



(Courtesy, Dow Chemical Co.)

Figure 17. Delicate instrument internally packaged to prevent damage from vibration in the Parcel Post environment.

D.3 TEMPERATURE ENVIRONMENT

The mailer must know how his product will react to possible temperatures in the mailstream. Products which can freeze or melt, expand or contract, crystallize or undergo chemical change, change in texture or color, rust, spoil, or decay at temperatures found in the normal Parcel Post environment, will require special packaging.

In the Parcel Post system, a parcel is usually exposed to the temperature environments of loading docks, postal facilities, and postal vehicles. Postal facilities, because they are normally heated and air-cooled, present no temperature problem. Temperature changes between loading docks and the inside of postal buildings can be large, but parcels are usually exposed to the temperatures of loading docks for very short times. In postal transport vehicles, however, parcels may be exposed to relatively extreme temperatures for relatively long periods of time. This is particularly true in the case of mail vans which are neither heated nor cooled, and some small charter mail aircraft.

Temperatures inside vans can range from -20°F to $+180^{\circ}\text{F}$, depending on the season and the geographic area. It is not uncommon to record temperatures of $140-160^{\circ}\text{F}$ inside vans in hot, sunny climates. A parcel may spend from 2 to 24 hours being transported in such an environment.

Appendix A presents a listing of high and low temperatures for selected cities in each of the fifty states. While these temperatures do not necessarily reflect temperatures at post office loading docks or inside vehicles, they can give the mailer a rough guide as to the temperatures his parcel will experience. The mailer must be aware that the Postal Service cannot assume responsibility for damage if the contents of a parcel have not been given reasonable protection from the effects of temperatures normally expected in the Parcel Post environment.

D.4 RELATIVE HUMIDITY ENVIRONMENT

Moisture in the air can affect packaged products and the strength of packaging materials. Some moisture conditions can, for example, cause some products to rust, corrode, mildew, or swell. Paper-related packaging materials (such as fiberboard, paperboard, and paper) have very different characteristics and protective qualities depending on the moisture environment and changes in that environment.

Relative humidity is a way of expressing moisture in the environment. Basically, relative humidity is the amount of moisture in a given amount of air relative to the amount of moisture that air can hold, at various temperature levels.

- If the amount of moisture in the air stays the same, as the temperature decreases, relative humidity increases.

- At high temperatures and high relative humidity, if the temperature drops quickly, the relative humidity will go up quickly. If the relative humidity reaches 100%, the air will not be able to hold all the moisture, and condensation or "sweating" will occur.

For example, suppose that parcels are loaded into a mail van in a place where the temperature is 80°F and the humidity 50%. The van is then tightly closed (so that air does not move freely between the van and the outside) to begin its journey. If the truck travels into an area with lower temperature, the relative humidity inside the van will increase. When the temperature inside the van reaches 60°F, the relative humidity will be 100% and condensation will form.

Paper and paper products are very susceptible to the effects of relative humidity because they absorb and release moisture readily. The fibers in paper products get very brittle when the relative humidity gets very low (about 20% and lower). These fibers get very pliable but weak when the relative humidity gets high (about 65% and higher). When relative humidity is low, paper containers can become brittle and break on impact. When relative humidity is high, those containers may collapse under impact or under the weight of their contents.

The mailer must use waterproof containers or waterproof internal packaging when mailing products that may be damaged by exposure to water or high relative humidity. To protect products which are susceptible to the effects of high relative humidity, the mailer can enclose the product and a moisture adsorbing material (desiccant) such as silica gel, in a sealed moisture-proof wrapping. When mailing parcels to, from, or through areas which may have extreme relative humidity levels (below 20% or above 65%), the mailer should consider using non-paper containers or paper containers that have been treated to resist the effects of relative humidity.

Table 3 presents summer relative humidity levels and temperature changes for selected cities in all fifty states. See Appendix A for average high and low temperatures for each month.

Table 3
Climate Conditions June Through September

		Relative Humidity*	Daily Range in Temperature**
Alabama	Montgomery	50	21
Alaska	Juneau	68	15
	Fairbanks	43	24
	Barrow	82	12
Arizona	Yuma	25	27
	Flagstaff	25	31
	Tucson	24	26
Arkansas	Little Rock	47	22
California	San Diego	52	12
	Eureka	70	11
	Sacramento	25	36
Colorado	Alamosa	28	35
	Denver	22	28
Connecticut	Harford	57	22
Delaware	Wilmington	55	20
Florida	Miami	61	15
	Daytona Beach	59	15
	Tallahassee	51	19
Georgia	Atlanta	50	19
	Savannah	54	20
Hawaii	Honolulu	60	12
Idaho	Idaho Falls	22	38
	Lewiston	18	32
Illinois	Chicago	56	20
	Springfield	53	21
Indiana	Evansville	49	22
	South Bend	55	22

* Highest daily values that can be expected 97.5% of the time during a normal summer.

**The difference between the average maximum and minimum temperatures during the warmest month.

Table 3 (Cont.)
Climate Conditions June Through September

		Relative Humidity*	Daily Range in Temperature**
Iowa	Burlington	53	22
	Sioux City	49	24
Kansas	Dodge City	32	25
	Goodland	26	31
Kentucky	Lexington	50	22
Louisiana	New Orleans	62	16
	Shreveport	50	20
Maine	Caribou	58	21
	Portland	57	22
Maryland	Baltimore	56	21
Massachusetts	Boston	51	16
Michigan	Alpena	57	27
	Detroit	54	20
	Grand Rapids	49	24
	Marquette	47	18
Minnesota	International Falls	51	26
	Minneapolis	52	22
Mississippi	Jackson	44	21
Missouri	St. Joseph	47	23
	Springfield	46	23
	St. Louis	47	21
Montana	Billings	25	31
	Glasgow	24	29
Nebraska	Omaha	49	22
Nevada	Elko	15	42
	Las Vegas	16	30
	Reno	15	45

* Highest daily values that can be expected 97.5% of the time during a normal summer.

**The difference between the average maximum and minimum temperatures during the warmest month.

Table 3 (Cont.)
Climate Conditions June Through September

		Relative Humidity*	Daily Range in Temperature**
New Hampshire	Concord	48	26
New Jersey	Trenton	55	19
New Mexico	Albuquerque	18	27
	Roswell	22	33
New York	Albany	51	23
	Buffalo	53	21
	New York	52	16
	La Guardia		
North Carolina	Asheville	51	21
	Wilmington	65	18
North Dakota	Bismarck	40	27
	Devils Lake	41	25
Ohio	Cleveland	52	22
	Columbus	57	24
Oklahoma	Oklahoma City	40	23
Oregon	Portland	39	23
Pennsylvania	Philadelphia	55	21
	Pittsburgh	54	21
	Scranton	54	19
Rhode Island	Providence	60	19
South Carolina	Charleston	56	18
	Spartanburg	46	20
South Dakota	Rapid City	31	28
	Sioux Falls	45	24
Tennessee	Nashville	47	21

* Highest daily values that can be expected 97.5% of the time during a normal summer.

**The difference between the average maximum and minimum temperatures during the warmest month.

Table 3 (Cont.)
 Climate Conditions June Through September

		Relative Humidity*	Daily Range in Temperature**
Texas	Amarillo	28	26
	Brownsville	59	18
	Ft. Worth	37	22
	San Antonio	40	19
Utah	Salt Lake City	20	32
Vermont	Burlington	57	23
Virginia	Norfolk	56	18
	Washington	50	18
Washington	Seattle Boeing	44	24
	Yakima	25	36
West Virginia	Huntington	49	22
Wisconsin	Green Bay	57	23
	Madison	54	22
Wyoming	Cheyenne	23	30
	Sheridan	21	32

* Highest daily values that can be expected 97.5% of the time during a normal summer.

**The difference between the average maximum and minimum temperatures during the warmest month.

D.5 FUTURE PARCEL POST ENVIRONMENT

The Postal Service is now undertaking a major program to improve the Parcel Post system. There are two primary aspects to this program: Bulk Mail Centers and "containerization".

- Bulk Mail Centers. The Postal Service is now building several very large parcel processing centers throughout the country. These Bulk Mail Centers will have very modern parcel handling and sorting equipment that has been specially designed to eliminate damage to adequately packaged parcels and to improve delivery time.
- "Containerization". Such equipment as sacks and hampers have always been used in the post office to combine mail so that handling and processing would be more efficient. As mailing patterns have changed, the volume of mail between major cities has steadily increased. Because of this, the Postal Service has been able to begin using a new way of combining mail. Essentially, large containers are used for parcels which are going to high volume destinations. Once placed in these large containers, the individual parcels are not usually handled again until they are unloaded for final sorting and delivery. Such "containerization" tends to reduce the effects of the environment on individual parcels because they receive less handling. Consult your local Customer Service Representative for palletization and containerization programs if you are a medium to large volume mailer.

CHAPTER 4

PACKAGING FUNDAMENTALS

Chapter 3 discussed factors that influence the packaging of products. The mailer is responsible for being aware of certain factors when preparing parcels for the Parcel Post system:

- Product characteristics such as value, size, weight, shape, density, and susceptibility to damage from jolts and vibrations;
- Special rules that must be followed for mailing some normally "nonmailable" items; and
- Parcel Post environmental influences such as expected temperatures, relative humidity, shocks, and vibrations in the mailstream.

This chapter presents a general catalog of packaging materials, describing the basic kinds of external shipping containers (Section A), internal packaging materials (Section B), and closures (Section C). Once the mailer "knows" his product and understands the postal environment, he can use this chapter to choose packaging materials which have the proper characteristics for his mailing needs. Section D discusses the selection, preparation, and application of address labels.

The common varieties of each packaging component (shipping container, internal packaging, or closure) are listed in this chapter. Following each title are listed packaging characteristics, construction, and general use information. (It should be noted that Chapter 2 presents a packaging Guidelines Table (Table 1, pages 6-14) which can be used to find general packaging requirements. Chapter 4 presents a detailed, technical discussion of the characteristics of the packaging materials listed in the Table.)

A. EXTERNAL CONTAINERS FOR SHIPPING PARCEL POST

The mailer can choose among many different kinds of containers for Parcel Post packaging. For purposes of this handbook, these "kinds" are broadly classified as rigid, semi-rigid, flexible, combination and miscellaneous. Within each of these groups, there is wide variety of types, styles, sizes, shapes, openings, and flute combinations. Performance characteristics are also numerous and include water-resistance, surface treatment, ability to cushion the contents and to resist puncture or crushing.

Each container has design limits (maximum stress points) which, if exceeded, may result in its damage or destruction. The design limit is affected by the manner in which the container is used, so the exact point of failure is not always the same. For many containers, the stress limit is printed on the outside, but for others it is not shown because the container manufacturer thinks that the nature of the contents can so influence container performance that stress limit figures would be misleading.

The design limits in this Handbook for shipping containers show the relationship of the "strength" of the shipping container to the density or weight of the contents. These "strength"-to-density relationships will provide a practical and useful key to most container selection. The mailer must, however, be sure that good packaging practices are observed and that unusually severe conditions are taken into consideration.

A.1 RIGID CONTAINERS: DRUMS, FIBER

(a) Construction: A straight-sided shipping container made of convolute (wrapped on itself) layers of fiberboard material, no one ply (layer) of which is less than .012 inches thick.

(b) Liner: Low density polyethylene is often used as an inner liner. The newer adhesives and treatments that increase the strength, barrier properties, and durability of fiberboard, permit an unlimited range of products from solids to liquids to be packaged and transported in fiber drums.

(c) Capacities: From 1/2 gallon to 10 gallons.

(d) Bottom: Usually a tightly secured bottom with full, removable metal, plastic, or fiberboard cover.

(e) Cover: Held on by locking type rims, pressure sensitive tapes, or metal clips.

(f) Uses: Dry products and those sensitive to gain or loss of moisture. Water vapor barrier material such as foil-film combinations can be built into side wall construction and into fiber bottoms and covers. If the covers are metal, this protection is achieved by lacquering. When a fiber drum is used for liquids in internal containers, other than glass or other breakable material, a plastic liner may be placed inside along with a coating of plastic or other inert material on the interior surface. Locking rims and gaskets should be employed to hold the metal cover fast when liquids are packaged. Such combinations make excellent, relatively inexpensive containers. Fiber drums may also be used for shipping rolled materials such as plastics, cellophane, and waxed paper.

(g) Custom Designs: Interior compartments and suspension supports can be designed for sending delicate items like electronic tubes, timing devices and some auto parts. The use of a drum within a drum, with insulating material between the two containers, gives strong shock and vibration protection of delicate items.

A.2 RIGID CONTAINERS: CANS, FIBER

(a) Construction and Features: Essentially similar to fiber drums (above) and may be laminated with other materials to form a "composite" fiber can (See A.3).

(b) Capacity: From 1/2 pint to 1 gallon.

(c) Closures: Methods of closure vary from one manufacturer to another.



(Courtesy, Grief Brothers Corp.)

Figure 18. Two methods of closing fiber cans.

A.3 RIGID CONTAINERS: COMPOSITE CANS AND TUBES

(a) Construction: Composite cans and tubes obtain their strength from the use of paper or paperboard of various grades, bonded in a number of layers or plies. Other materials, such as aluminum, steel foil, and plastics are used in combination with the paper or paperboard to obtain desired physical characteristics.

(b) Closures: Ends of the cans are usually seamed onto the bodies. Ordinarily, ends are made of metal, either steel or aluminum, although paper and plastic ends are sometimes employed. Cans usually are delivered to the customer with one end already seamed on. Contract filling companies may be employed to fill and close the cans.

(c) Types of Composite Tubes and Cans: One type of composite can may be delivered with a plain bottom and a single or double friction plug on the top. The plug ring is seamed onto the top by the can manufacturer and plugs are delivered separately. After filling, plugs can be inserted into the ring by the user without special equipment. Another type of composite can which may be conveniently used for Parcel Post mailings has a screw-on end actually threaded to the can body or to a metal ring which has been seamed onto the can body. This type can is used widely for mailing medical specimens as well as for a variety of other items. It requires no special closing or opening equipment.

The simplest type of composite tube is one with paper "cuffs" bonded to each end of the tube. After an item is inserted, the cuffs are folded inward to keep the contents in the tube during mailing. This type of tube is particularly useful for rolled sheets of paper, such as calendars, which tend to expand toward the inner surface of the tube after insertion.

Mailing tubes may also take a form similar to composite cans, using either metal ends seamed on, or one metal end with screw type closure. These closures, which completely cover the ends of the tubes, permit the mailing of a wide variety of items.

Perhaps the most versatile type of mailing tube is the telescopic, or three-piece, which usually is constructed with two metal ends seamed on, an opening in the center of the tube, and an inner tube glued to the inside of one part of the outer tube. The unglued portion of the outer tube slips off the inner tube in a "telescoping" manner. This type of tube is usually closed by applying a suitable tape around the joining sections of the outer tubes.

(d) Uses: Composite cans and tubes are widely used for mailing promotional advertising materials, sheet paper goods such as maps and calendars that should not be folded or creased, medical specimens, and water samples. (See page 25, Chapter 2, for illustration.)

A.4 RIGID CONTAINERS: CANS, METAL

(a) Construction: Metal cans of sheet steel or aluminum are the strongest, most convenient containers available for transportation and storage environments. They withstand heat, cold, and moisture and are virtually unbreakable. The thickness of the metal varies depending on size or volume of the can and its probable contents. The range of sizes is almost unlimited.

(b) Closures: The bottom is nearly always seamed on. Tops range from fully seamed-on to hinged, multiple friction, and plastic caps. Many cans are custom designed for special uses or for artistic appeal.

(c) Linings: A multiple of coatings or linings, often called "can enamels", have been developed to prevent interaction between sensitive or reactive products and the metal of the can.

(d) Shapes and Sizes: Almost limitless to meet varying requirements for items ranging from pills and baby powder to paints.

(e) Uses: Almost unlimited. (See page 24 for illustration.)

A.5 RIGID CONTAINERS: PAILS AND DRUMS, STEEL

(a) Construction: Single-walled containers cylindrically constructed of sheet steel, 29 gauge and heavier.

(b) Capacities: 1 to 10 gallons.

(c) Closures: Bottom usually seamed on; two types of heads (tops), the "tight head", which is a permanent top (seamed on) obtainable with a retractable spout of some kind, and the "open head" pail which is most commonly fitted with a cover held on by a series of lugs around the edge.

(d) Uses: Largely used for mailable chemicals, petroleum products, paints, varnishes, janitorial supplies, etc.

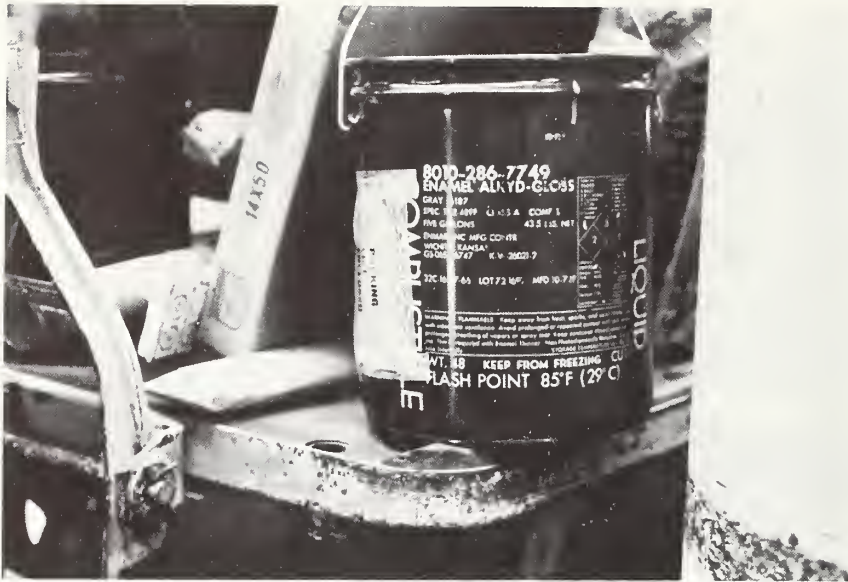

Figure 19. Five-gallon steel pail.

(NBS)

A.6 RIGID CONTAINERS: BOXES/CRATES/BASKETS, WOOD

(a) Construction, boxes: Wood boxes are completely closed structures. Strength comes from the thickness of the wood and the way in which the box is constructed. (See page 23 for illustration.)

(b) Construction, crates: Wirebound wood crates are partially open containers with each face having open slits or spaces between the boards. Ends are usually solid for greater strength. Wirebound boxes and crates offer a high strength-to-weight ratio. (See page 22 for illustration.)

(c) Construction, baskets: Made from veneer blanks or splints, hooped and banded together.

(d) Uses: Wood containers provide rugged, durable protection for many items. Openings for ventilation do not weaken wooden containers significantly.

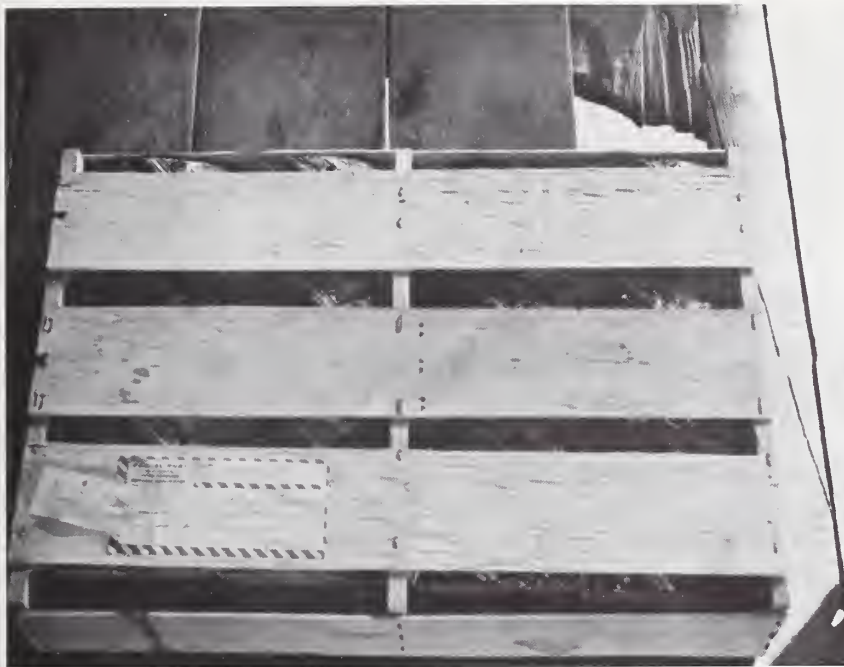

Figure 20. Wood crate, stapled and nailed. (NBS)

A.7 SEMI-RIGID CONTAINERS: BOXES, CORRUGATED FIBERBOARD

Corrugated containers have often been called the "workhorse" of the packaging field. Their use is so extensive that the rates of manufacture and shipment of new boxes have been regarded as an indicator of how the national economy is doing. Their usefulness is so extensive that it is difficult to think of items that cannot be packaged in corrugated boxes.

(a) Construction: By far the most common construction is single-wall corrugated fiberboard, in which a wavy or fluted sheet of corrugated material is sandwiched between, and glued to, two facings.

To increase strength and rigidity additional corrugated layers may be used. Three facings may be combined with two corrugated layers to form double-wall corrugated fiberboard. Triple-wall corrugated employs four facings glued to three corrugated layers. (See page 26 for illustration.)

(b) Strength: The weight and strength of the facings, the weight and strength of the corrugated layers, the height and number of flutes (waves) per foot, and the number of walls (single, double or triple) determine the strength and durability of the walls of any corrugated fiberboard box.

(c) Flutes: Four flute structures are available. A-flute has the greatest capacity to absorb shock because of the wider spacing of its flutes. B-flute provides maximum crush resistance because of the greater number of flutes per foot. C-flute to some extent combines the properties of both A and B. There is also an E-flute for use when very thin corrugated board is desired.

Table 4

NUMBERS AND HEIGHTS OF FLUTES IN CORRUGATED FIBERBOARD

<u>Number of Flutes per Linear Foot</u>	<u>Approximate Height (not including thickness of facings)</u>
A-flute 36±3	3/16 inch
B-flute 50±3	3/32 inch
C-flute 42±3	9/64 inch
E-flute 94±4	3/64 inch

(d) Joints: Another key factor in corrugated container construction is the "manufacturer's joint" which is the part of the box where the ends of the corrugated fiberboard sheet are joined together. The most commonly used methods of making the joint are stitching, gluing and taping.

(e) Sizes: The size of the box is determined by its inside dimensions of length, width and depth. The length is always the larger of the two measurements of the open face and the width is the smaller. The depth is the distance between the innermost surfaces of the box measured perpendicular to the length and width. RSC is a common abbreviation for "regular slotted container". It is the most commonly used style but corrugated containers can be "tailor made" to fit almost any need. (See pages 15-18 for illustrations.)

A.8 SEMI-RIGID CONTAINERS: BOXES, SOLID FIBERBOARD

(a) Construction: Solid fiberboard is made by gluing or laminating together two or more plies of paperboard to form a single sheet; there is no corrugated layer. Thicknesses usually range from 50 to 160 points, (0.050 to 0.160 inches). The manufacturer's joint of solid fiberboard boxes is stitched or glued.

(b) Uses: These containers have proven in both commercial and military usage to be tough and resistant to weathering. Use for products requiring support from the external container and protection from exterior environment.

A.9 SEMI-RIGID CONTAINERS: BOXES, FOLDING CARTONS

(a) Construction: Folding cartons are made from a paperboard that resists breaking and cracking even when folded as much as 180 degrees. Available in a wide variety of sizes and shapes, these boxes are either folded and delivered flat or glued and then collapsed by the maker for later set-up, filling, and closing at the place of use.

(b) Grades: The grades of paperboard used for folding cartons are ordered or designated by weight (in pounds per 1,000 square feet), in thickness (by thousands of an inch as measured by caliper), and by density (in pounds per caliper point). Thicknesses usually range from .010 to .046 inches.

Commercial grades are known by a variety of names: bending chipboard; bending newsboard; single, manila-lined board; bleached, manila-lined board; white, patent-coated board; clay-coated board; and, solid board. Selection of any particular grade of board depends upon the performance and appearance required for any particular use. Performance of the board is also influenced by its physical properties which are in turn determined by carton fabrication or forming.

(c) Choosing an Appropriate Carton: Strength requirements of folding cartons are influenced by the weight, contour or shape, and degree of support provided by the contents, as well as by the size of the carton and the rigidity of the closure.

(d) Limitation on Use: Only those articles which will not be damaged by distortion of the box should be packed in folding cartons. The manner in which an article is packaged determines to a great extent its condition on arrival at its destination.

(e) Closures: The type of closure used must fit the style of the box. Locking devices are available but must be carefully assembled. Telescoping boxes should normally be fastened by gummed or pressure-sensitive tape which sticks well to the surface of the box.

(f) Uses: Folding cartons are usually made on special order for specific products. Some of these items include: cards, cosmetics, and toiletries. Folding cartons are also used as internal containers for many products such as toys, hardware, sporting goods, and clothing.

A.10 SEMI-RIGID CONTAINERS: BOXES, SET-UP

(a) Construction: In their simplest form, set-up boxes are square-cornered, two-piece containers made of short-fiber, nonbending grades of paperboard and are reinforced at the vertical edges with stays. Stays are made of paper with a minimum basis weight of 80 lbs. Stays of muslin, metal or other material are also used. Some boxes are self-stayed or ended by using a flap from the box side. Although stays help strengthen a box, set-up rigidity is primarily derived from two basic elements: rigidity of the nonbending boxboard and the noncollapsible feature inherent in set-up box construction.

(b) Weaknesses: The two weakest structural elements of set-up boxes are the corner stays and the scorelines. Rupture of the corner stays or breaking of the creases occurs on some styles of boxes when they are subjected to severe stresses or loads. These weak areas can be strengthened by applying reinforcing tape at the corners or around the boxes.

(c) Shapes: The basic method used in forming these boxes permits a large variety of shapes and styles. They are usually designed with a base or bottom and a lid, with the two most common styles of set-up boxes being the full-telescope and those with trays or slides.

(d) Choosing a Set-Up Box: When the weight of the goods have been established, an appropriate grade of paperboard in terms of thickness and bursting strength can be selected from Table 5. The Table can be read as follows:

- Use as your starting point the weight of the goods to be packaged and find the correct row in Column 1, Weight of Contents.
- If the goods to be packaged will support the box from the inside, follow the weight line you chose across the Table to "Thickness". The figure in this column will tell you how thick a paperboard you should use on your package before any lining or coating is applied.
- Continue reading across the same line to the last column. This figure will tell you the basis weight for the thickness of paperboard selected.

Table 5 Relationship of Weight of Contents to Thickness and Basis Weight for Setup Paperboard Boxes

<u>Weight of Contents in Pounds</u>	<u>Thickness in Inches</u>	<u>Basis Weight per 1000 Square Feet in Pounds</u>
1/4 or less	0.026	90
over 1/4 to 1/2	0.028	96
over 1/2 to 3/4	0.030	103
over 3/4 to 1 1/2	0.032	111
over 1 1/2 to 3	0.035	120
over 3 to 5	0.038	131
over 5 to 7 1/2	0.043	144
over 7 1/2 to 10	0.048	160

For example, suppose your goods weigh four pounds. Four pounds is between 3 and 5 pounds, the sixth item down in the "Weight of Contents" column. If you follow line 6 across, you will find that you need a paperboard 0.038 inches thick for your container and that this board has a basis weight of 131 pounds, as shown in the last column. If you buy a box for shipping your goods, you will ask for paperboard with a basis weight of 131 pounds, of the size to house your product.

Set-up boxes made of bending boards should be used as external containers only when the contents will give internal support to the box. In the case of nonsupporting contents, the values given in Table 5 do not apply.

(e) Linings: Set-up boxes are available with a large variety of coatings, linings and treatments. They can be obtained plain, water or grease resistant, and in combination. Plain boxes are intended for use in packaging dry items which are free from water and grease. Water resistant boxes carry such items as starch, detergents, or metal parts subject to corrosion. Grease resistant boxes house items that are only lightly coated with oil or grease. When there is a possibility that large amounts of free oil or grease may accumulate, different packaging is required.

Water resistant often refers to the internal lining of the box and does not necessarily mean weather resistant. When boxes will be exposed to the weather, additional protection such as wrapping in weather-proof paper should be provided.

(f) Uses: Set-up boxes are particularly suitable for packages where rigidity is needed. The full telescope style is excellent for packaging self-supporting products and is used extensively for Parcel Post.

A.11 FLEXIBLE CONTAINERS: BAGS AND SACKS

(a) Construction: The bag is basically a sleeve or tube made from various kinds of flexible materials--paper, plastic, foil, textiles, or some combination of these. It may be plain or padded and it is often reinforced and provided with cushioning or stiffeners but is never completely rigid.

Unpadded or "Utility Shipping Bags" are of a flat, laminated design in which layers of one or more materials are pressed together and held by means of adhesive, solvent or heat treatment. (See Section A.12 for additional information about materials.) When unpadded bags are laminated with half-inch fiberglass mesh for added strength, they are called "reinforced shipping bags".

Padded shipping bags combine cushioning, water-resistance and temperature insulation in a single container. Several materials and types of construction are available--single-face corrugated paper, plastic foam, air cells, and macerated paper cushioning. The plastic versions provide waterproof cushioning but other varieties have absorbent inner liners which will soak up liquids when necessary, thereby preventing contamination of adjacent packages in the mailstream. (See pages 19-21 for illustrations.)

(b) Closures: Both padded and unpadded bags or sacks are usually closed by tape, stapling, stitching, gluing or heat sealing. Heat sealing is possible only where the manufacturer has provided thermoplastic mating surfaces. This type of sealing requires use of a proper heat seal machine and care in following the instructions with regard to temperature, pressure, and dwell time, if effective closures are to be made.

(c) Styles: Many styles are available in the open market.

(d) Uses: Padded bags and sacks may be used for shipping books, spare parts and a wide variety of other self supporting items when adequate padding is provided. They also provide excellent protection for fragile items within another shipping container.

Unpadded bags are widely used to protect small, nonfragile items which have fairly even shapes such as paperback books, pamphlets, soft goods and notions.

Multiple books or documents must be unitized by tying or banding in a group or in groups before packaging in any type of container.

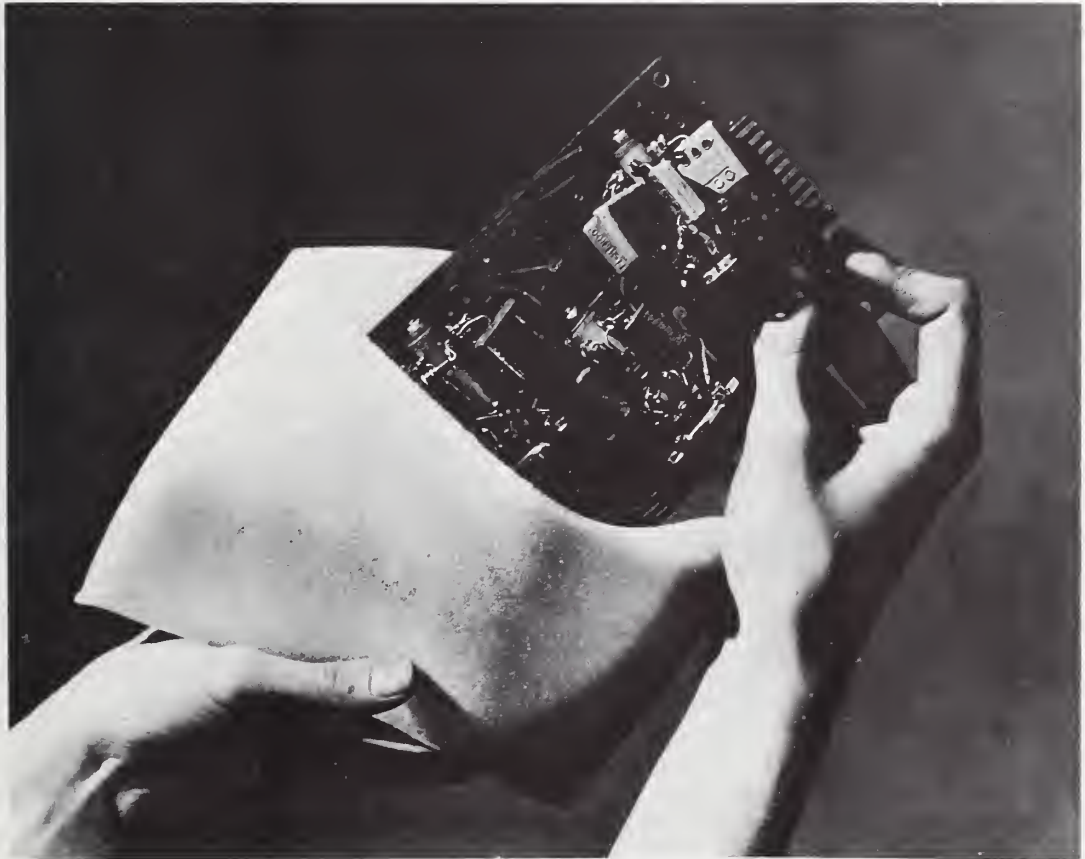

(Courtesy, Dow Chemical Corp.)

Figure 21. Polyethylene foam bag for internal packaging.

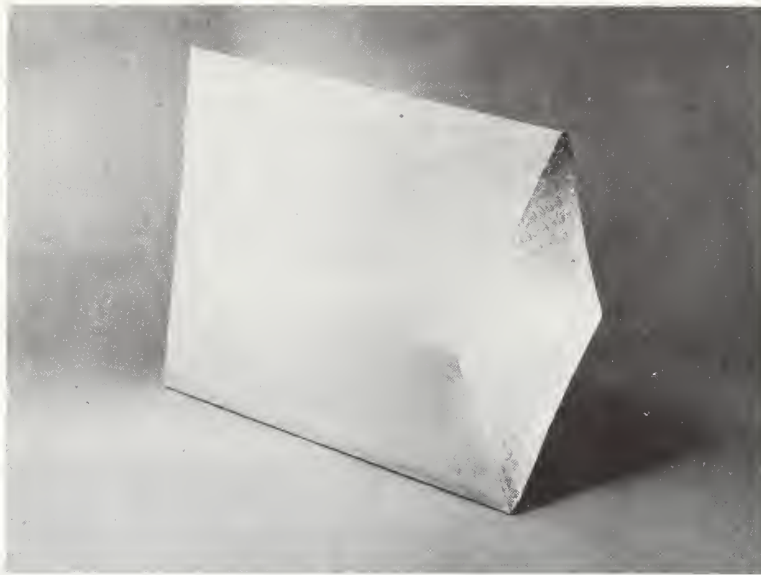

(Courtesy, Sealed Air Corp.)

Figure 22. Bag with bubbled-plastic cushioning.

A.12 FLEXIBLE CONTAINERS: HEAVY DUTY BAGS OR SACKS

(a) Construction: Bags and sacks which will carry bulky or heavy items safely through the mail are classified as heavy duty. Many kinds of materials are used in the construction of these containers such as: multiwall paper; paper and plastics; laminations of paper, film, and textiles; meshes; textiles; and all plastic. This type of external container is only suitable for items which do not require internal protection.

Combination paper and plastic bags usually have an inner, barrier layer (ply) which can be totally heat sealed before the outer bag top is closed. "Saran" is often used for coatings or inner plies when it is desirable to hold odor, grease or chemical vapor inside the package.

Meshes used either as complete bags or as inner reinforcement for other layers are made from yarns twisted from special kraft papers or plastics. When mesh is used alone it offers complete ventilation for soft goods.

The all-plastic bag is usually made of high density polyethylene. It is transparent and heat sealable. It resists weather and tearing.

Bags and sacks made completely from textiles usually employ burlap, cotton and synthetic fibers (mostly polypropylene). These containers are extremely strong and highly tear and snag resistant.

(b) Closures: See paragraph A.11 (b) above.

(c) Capacities: The capacity depends on the kind of material used, the size of the individual bag or sack, and Postal Service weight limitations.

(d) Uses: Heavy duty bags and sacks are used for shipping hardware and tools for the farm and garden which require no protection from the external containers.

A.13 FLEXIBLE CONTAINERS: ENVELOPES

(a) Construction: As special form of flexible packaging these envelopes are usually die-cut to shape, sealed on three sides, with the fourth side open with an extension flap. Materials for envelopes range from glassine to kraft and manila papers, heavyweight kraft-lined board, plastic films and various laminations.

(b) Closures: Envelopes may be permanently sealed by gummed flaps or by a variety of reusable closures including clasp and snap fasteners, string and button or latex strips.

(c) Uses: Very small items requiring no protection from the external containers are usually shipped in envelopes: watch parts, zippers, and small machine parts.

A.14 FLEXIBLE CONTAINERS: SHRINK WRAPS

(a) Construction: When a shrink film is heated, stored energy is released, pulling the film back toward its original unstretched condition. To use shrink film, an item is first wrapped loosely by hand or machine in the film and the tightening (shrinking) occurs when the package is passed through a heat tunnel or, in many cases, through a simple hot air stream. The shrink can be speeded or its reduction increased by raising the temperature and/or the velocity of air blown against the package.

Of the dozen or more types of film on the market, some will shrink at temperatures as low as 160°F, which permits the use of hot water as a tightening agent. Others require temperatures of up to 330°F for proper shrinking.

(b) Uses: The distinct advantage of shrink wraps is their contour fit around odd-shaped products. They secure multi-part products and prevent movement inside packages, thereby reducing scuffing or breaking. Shrink wraps also can be used as internal packaging to suspend (in a hammock type arrangement) items that must have shock protection during shipment. As with most plastic wraps, shrink films offer varying degrees of protection against water vapor and gas transmission. Shrink wraps are recommended as external containers only for products which are self-supporting and require minimal protection.

A.15 COMBINATION CONTAINERS

(a) Construction: As the name implies, the principle is a simple one--put together any two or more kinds of containers so the goods will have the best possible protection. The most frequently used combinations are to put one container inside for internal packaging and the other on the outside to take the brunt of shock and abrasion in shipping.

Combinations are not limited to putting standard containers together. Two or more materials may be combined into a single packaging web by means of adhesive, solvent or heat. Films, foils and paper can be laminated either in combinations or by employing several layers of the same kind of material. In either case the resultant product has greatly increased strength as well as other desirable qualities.

(b) Types: Many combinations are readily available: plastic liners within corrugated drums; shrink-wrapped articles within a corrugated or fiberboard box will give product stability inside a shock resistant container; one bag or envelop within a carton will give much greater protection than either alone. Extra protection can be produced by placing a layer of loose fill internal packaging material between the inner container and the outer container. The opportunities for combination are limitless.

A.16 MISCELLANEOUS CONTAINERS

(a) Rigid Plastic: Vials and sleeves of rigid plastic are frequently used to ship small items such as nuts, bolts, tools, and jewelry. They act as good moisture and gas barriers and provide rigidity for the protection of their contents.

Rigid plastic vials are, however, more often used as internal containers because sharp impacts crack them and high temperatures encourage them to melt. They are available in many shapes and sizes, with closure methods that fit the style used.

(b) Wraps and Overwraps: A wrap is simply a sheet of flexible material formed about some product or item. It should be distinguished from the overwrap which forms about or covers a primary package, such as an outside carton.

Wraps and overwraps as primary packaging often snag, tear; they give no shock (impact) protection. Unless the item to be mailed is rigid and strong in itself and has a shape around which a wrapping can be securely formed, the mailer should not rely on wraps for primary packaging.

B. INTERNAL PACKAGING

Proper selection and use of internal packaging materials will help packaged products to arrive at their destinations in perfect condition. Because there are many methods of internal packaging and many kinds of materials, however, choosing correct materials and using them properly is not a simple task. In general, internal packaging can either prevent damage to the item being mailed, or it can give additional strength and support to the external container, or both.

The mailer must know about three areas (in addition to the external container) if he is to choose proper internal packaging materials and use them correctly: Aspects of these three areas are listed below. They are discussed in more detail in Appendix B, page 162-171.

- Internal Packaging Functions: Cushioning, separation, retention, suspension, surface protection, blocking, bracing, absorption, adsorption, corrosion protection and contamination protection;
- Characteristics of the Item Being Mailed: Fragility, size, weight, shape, surface finish, and possible disassembly.
- Characteristics of Internal Packaging Materials: Compression set, resiliency, rate of recovery, damping, abrasion, corrosion, fungus resistance, temperature performance, dusting, and absorbency.

The table on the following two pages provides a summary of the performance characteristics of internal packaging components. The table is a brief summary and can be used as guide for reading the more detailed information in Sections B.1 through B.16.

Table 6

QUALITATIVE PERFORMANCE CHARACTERISTICS

INTERNAL PACKAGING COMPONENTS	Resilient	Compression Set	Resist Moisture	Absorb Impact	Dust-Free
Sealed Plastic Internal Container Film	no	N.A.	yes	N.A.	yes
Shrinkable Plastic Film	no	N.A.	yes	N.A.	yes
Polyethylene Film Cushioning	yes (high)	low	yes	good	yes
Polyethylene Foam	yes	low	yes	good	yes
Urethane Foam	yes	low	yes	good	yes
Polyurethane Foam	yes	low	yes	good	yes
Vermiculite	yes (low)	high	no	poor	no
Bound Fiber Cushioning	yes (high)	low	yes	good	no
Polyvinyl Chloride Foam	no	low	yes	N.A.	yes
Hair Felt	yes (med.)	med.	no	med.	no
Expanded Polystyrene	yes	med.	no	good	no
Cushioned Wrapping	yes (low)	med.	no	med.	no
Plastic Foam Sheeting (Polypropylene)	yes	low	yes	good	yes
Loose Fill					
- Shredded Paper	yes (low)	high	no	med.	no
- Excelsior	yes (med.)	high	no	med.	no
- Expanded Polystyrene	yes	low	yes	good	yes
- Coated Fibrous	yes (high)	low	yes	med.	no
Wadding (Absorbent)	yes	high	variable	variable	variable
Solid and Corrugated Fiberboard	yes (med.)	med.	variable	med.	no

Table 6 (cont.) QUALITATIVE PERFORMANCE CHARACTERISTICS

INTERNAL PACKAGING COMPONENTS	Non-Abra-sive	Non-Cor-rosive	Flexible	Damp-ing	Absorbs Liquid
Sealed Plastic Internal Container	yes	yes	yes	N.A.	no
Shrinkable Plastic Film	yes	yes	yes	N.A.	no
Polyethylene Cushioning	yes	yes	yes	yes	no
Polyethylene Foam	yes	yes	yes	yes	no
Urethane Foam	yes	yes	yes	yes	no
Polyurethane Foam	yes	yes	yes	yes	no
Vermiculite	no	no	no	yes	yes (good)
Bound Fiber Cushioning	no	variable	yes	yes	no
Polyvinyl Chloride Foam	yes	yes	no	yes	no
Hair Felt	variable	yes	yes	poor	yes (small)
Expanded Polystyrene	yes	yes	no	yes	no
Cushioned Wrapping	yes	variable	yes	poor	yes (small)
Plastic Foam Sheeting (Polypropylene)	yes	yes	yes	yes	no
Loose Fill					
- Shredded Paper	no	no	yes	yes	yes
- Excelsior	no	no	yes	yes	yes
- Expanded Polystyrene	yes	yes	yes	yes	no
- Coated Fibrous	no	yes	yes	yes	no
Wadding (Absorbent)	variable	variable	yes	variable	yes
Solid and Corrugated Fiberboard	no	variable	semi	poor	yes (small)

B.1 SEALED PLASTIC INTERNAL CONTAINERS

Plastic bags or liners are usually made of polyethylene, a light-weight, thermoplastic material which is resistant to many chemicals and moisture. Most plastic bags are heat-sealed. Any tears or holes in the plastic will both greatly reduce its desirable qualities and its strength.

Polyethylene film 2 to 4 mils thick may be used as an inside wrap to protect against moisture, dust and dirt. It provides almost no cushioning for parcel contents. In thicknesses of 4 mils or greater, it serves well as bag or liner for certain open-top cans, pails or drums and will effectively prevent most chemical and physical interactions between container and contents.

Drum liners are either round bottomed or square bottomed. The square or straight-bottomed style is less expensive than the round and is intended primarily for boxes and cartons although it is frequently used with drums.

With the "bag-in-box" construction, the carton manufacturer either supplies the plastic liner attached to the corrugated or paperboard container or sends it separately for insertion by the mailer. Liners for these boxes should be a minimum of 4 mils thick and capable of being sealed.

The usual closure for plastic bags is the tie-off, but these bags can also be sealed by sewing, heat-sealing or stapling as appropriate. When ties are used, they should be long enough to both twist and tie.



(Courtesy, 3 M Co.)

Figure 23. Closure of plastic internal container.

B.2 SHRINKABLE PLASTIC FILM (SKIN AND SHRINK PACKAGING)

Polyethylene is the type of plastic film most commonly used for skin and shrink packaging. It is a typical thermoplastic that, after the initial forming, may be softened and reformed. When the film is produced, controlled stretching causes internal stresses in the material. When the film is heated again, the stresses relax and the film shrinks, conforming tightly to whatever solid object may have been placed in its path. The film gains toughness in the shrinking process.

Shrinking is usually accomplished by directing a blast of air, heated to between 320°F and 450°F, over the film-encased product. By varying the exposure time and temperature of the hot air stream, different characteristics in packaging can be obtained. Special types of films are available which use hot water (160-180°F) for shrinking. Polyethylene film should be at least 3 to 4 mils thick if good holding is to be assured after shrinking. For extra heavy loads such as canned goods, film thickness of up to 15 mils is recommended.

Shrink film has many unique applications in the packaging field. It unitizes products by sealing them on boards which can then be packed as single units. Its transparency simplifies product identification and it protects against rain, dust and other contaminants. It conforms well to the contours of regular and irregularly shaped products, offering a versatility not otherwise available. New machines and films are making other applications possible almost daily. Shrink packaging materials are available in either pre-made bag or straight, roll-stock form.

B.3 POLYETHYLENE FILM CUSHIONING

Constructed from a composite of two or more sheets of plastic film, polyethylene cushioning traps air between the layers in open or closed cells. Surfaces of the material are heat-sealable. It can be easily disposed of, but its high durability make it a natural candidate for reuse.

Polyethylene film cushioning is intended for internal wrapping and packing only. It protects merchandise well from shock, vibration, concentrated forces, contamination and abrasion during handling. It is flexible, moisture protective, energy absorbing and light in weight. Highly resilient under dynamic conditions, closed cell material tends to lose its resiliency if stored for long periods because the plastic stretches to relieve its internal pressure. It softens between 210°F and 260°F and becomes vulnerable to certain gases and vapors when heated to 140°F and above. Open cell material gathers air as needed and occupies less storage space for that reason. Detergents and some other chemicals encourage cracking, if they are left in contact with this plastic for long periods.

Among the many uses for polyethylene cushioning are: bags, pads, wraps and fillers. The softness of the trapped air make it an ideal wrapping for delicate and fragile items.

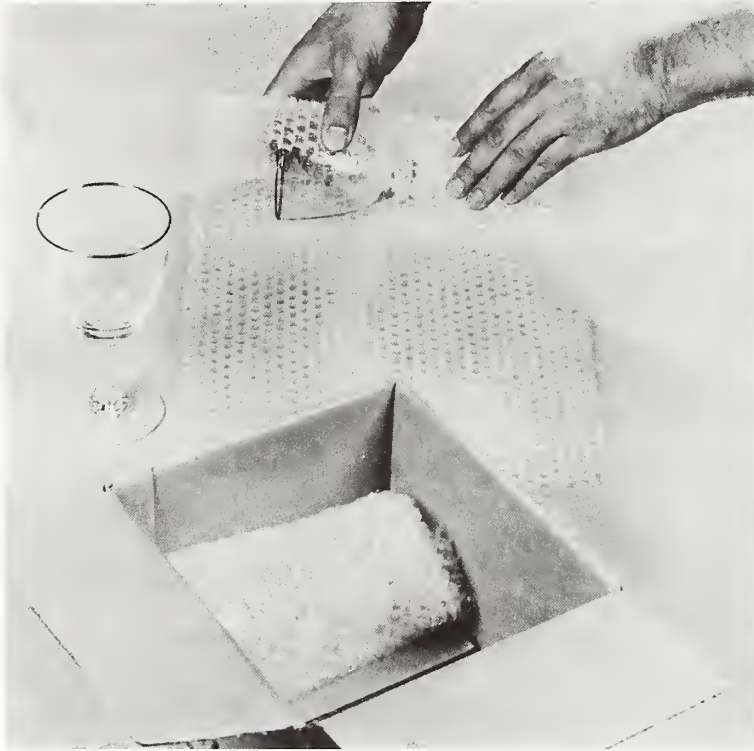

(Courtesy, Kimberly Clark Corp.)

Figure 24. Polyethylene film cushioning of a glass (open cell).

Polyethylene film cushioning has its limitations: It is not suitable for use in cushioning dense, heavy items. Under these conditions, the weight of the product tends to "pop" the bubbles on closed cell material, and flatten the open cell material.

B.4 POLYETHYLENE FOAM

Flexible, resilient and completely dust free, polyethylene foams come in many forms, shapes, densities and sizes. Expanded foam with a closed-cell structure which traps millions of tiny air bubbles, is an excellent material for cushioning and blocking. It defends the corners, edges and faces of merchandise from contact with the container walls and prevents products from sliding inside the container. Polyethylene foam has good recovery from compression as well as excellent tensile and tear strength. It can be easily sawed, sliced, or otherwise cut to create non-standard shapes for special applications. Figures 25-27 show examples of some custom fabrications.



(Courtesy, Dow Chemical Co.)

Figure 25. Corner and edge protectors of polyethylene foam.



(Courtesy, Dow Chemical Co.)

Figure 26. Use of polyethylene foam.

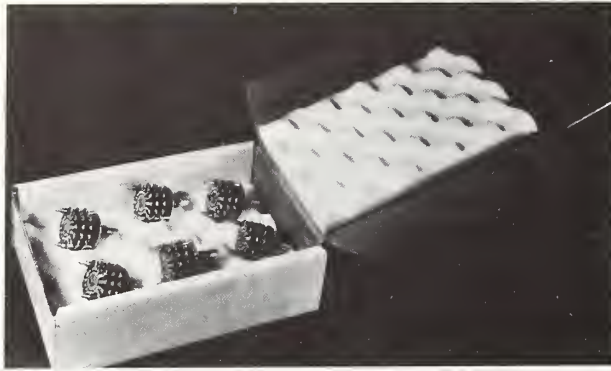

(Courtesy, Dow Chemical Co.)

Figure 27. Protection of electronic components with expanded polyethylene.

Small envelopes or bags, made from polyethylene foam are used in packaging small or delicate parts or mechanisms. These envelopes are smooth on both surfaces and the sleeve is formed by heat-sealing the edges on three sides. Polyethylene foam envelopes feature protection against shock and vibration.

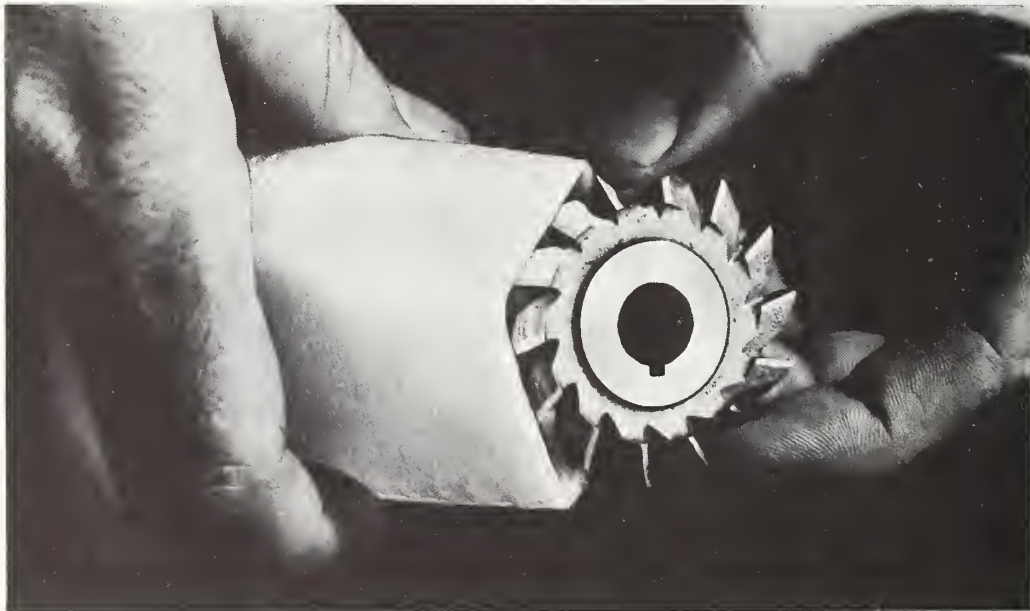

(Courtesy, Deitz and Assoc.)

Figure 28. Polyethylene foam envelope.

B.5 URETHANE FOAM

Urethane foam is produced by chemical reaction of certain compounds with polyesters. The by-product of this reaction is a cellular mass either rigid or sponge-like. Urethane foam comes in four basic forms:

- (1) molded internal packaging containers, usually contoured to fit the shape of the product;
- (2) large closed-celled slabs that can be cut or sliced into the desired thickness; and
- (3) various sandwich or laminated structures that combine a layer of foam with corrugated board or some other material.
- (4) Formed-in-place to encapsulate a product in its container.

While this material has several desirable properties such as resilience, thermal protection, and resistance to oxidation, oils, greases, and fungi, it may have some limitations. Some urethane foams by themselves do not absorb shock; others may adhere to the surfaces of items contacted unless the surface has been covered to prevent sticking.

If rigid urethane foam is chosen as the packaging material, a supplementing impact-absorbing, outer container may be necessary. A non-sticking film, such as a plastic bag or sheet, must surround the merchandise when urethane is formed or foamed-in-place.

B.6 POLYURETHANE FOAM

Polyurethane foams are chemically similar to those made from urethane. They are available in many densities and can be made to have almost any degree of stiffness depending on the strength of the gel during the blowing phase and the use during production. The foam can be made either strong and stiff with closed cells or soft and resilient with open cells.

The variations possible with polyurethane foams make them ideal for custom packaging of odd-shaped or delicate items. These foams lack a firm surface but the foaming process can be adjusted to give an internal packaging material of varying compression-set, resilience, or impact absorption.

One type of light-weight, cellular foam can literally be "foamed-in-place". Two components are mixed, one-to-one, and pressurized with nitrogen in a "foam gun". The liquid mixture is then ejected under pressure into a lined shipping carton where, by using simple molds or hand forming, the bottom of the box can be padded with foam which will take on

any desired shape. The item to be shipped is covered and then placed on the molded foam base and the blowing operation is repeated to fill the remainder of the open space in the box. One solution expands to a semi-rigid polyurethane mass 100 times its former volume in about 7 seconds, followed by a drying time of 15 seconds. The merchandise is thus suspended in a sort of foam cocoon. The resultant package is extremely light and excellently protective. Manufacturer instructions regarding ventilation during the foaming process should be followed carefully.



(Courtesy, Instapack Corp.)

Figure 29. Procedure for applying "foamed-in-place" polyurethane.



(Courtesy, Instapak Corp.)

Figure 30. Mold formed by polyurethane foam-in-place process.

B.7 VERMICULITE

Expanded vermiculite is widely used as a filler material for the internal packaging of liquids because it absorbs liquids very well but does not dissolve in water. As a mineral, it is classified as fireproof.

As packing, vermiculite has disadvantages: It collects dust and dirt and it does not normally absorb shock. Items packed in vermiculite must always be sealed first in some other container or packaging material to prevent the infiltration of dust into the merchandise. Additional packaging material must be used to protect against shock and vibration.

B.8 BOUND FIBER CUSHIONING MATERIALS

A variety of coarse natural hair, vegetable, or synthetic fibers may be bound with an elastic material to make a cushioning material. Sterilized cattle and horse hair, sisal, and cactus fibers are sprayed with latex to form an intricate mass of intertwined fibers to produce a range of soft to firm sheets or molded forms.

Rubberized fiber has high resilience and low compression-set and it does not disintegrate under rough treatment. It has minimal corrosive effects and its moisture content and absorption capabilities are both minimal. Rubberized fiber is best used for protecting items against vibration and shock where resilient, water-resistant cushions are required.

Packing with rubberized bound fiber cushioning prevents interior movement of goods by either two methods: If the product is irregularly shaped and small, it can be completely enveloped or sandwiched by folding a sheet of rubberized fiber around the item; if the product has a regular shape (square, rectangle, cylinder), the rubberized fiber can be cut into spacer pads to lend internal support to the package and to retard interior movement. Pads should be so positioned as to eliminate contact between the product and any of the six interior surfaces of the container. The padding should be from 1 to 2 inches thick and of a density which will lend proper support.

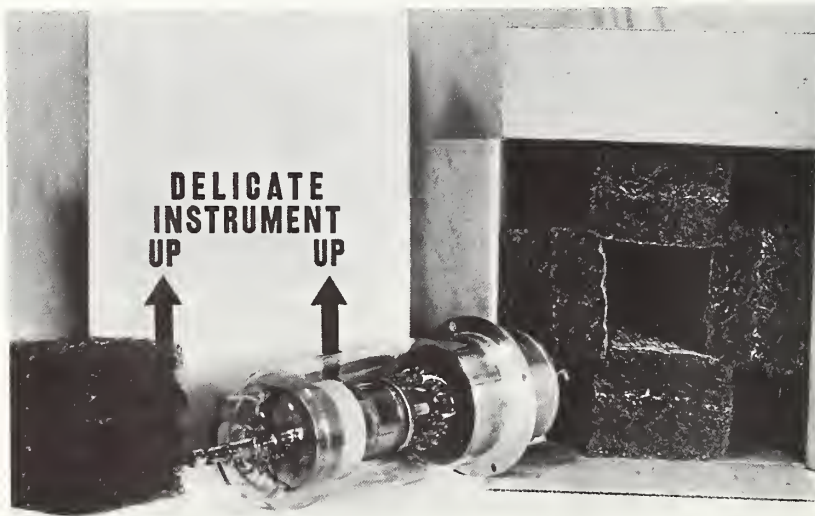

(Courtesy, Blocksom and Co.)

Figure 31. Use of six pads of rubberized hair for packaging a fragile item. (Note that the corners and edges of the container can be compressed without displacing the item.)

B.9 POLYVINYL CHLORIDE (PVC) FOAM

Another plasticized material with many excellent characteristics is polyvinyl chloride foam . It is often coated with a permanently bonded flexible material for adhesion resistance. In performance it is resilient, low in compression-set, non-dusting, non-corrosive, and fungus and fire-resistant. It has almost no moisture content of its own and absorbs virtually none from other sources. It may be purchased in either flat sheets or custom molded forms.

B.10 HAIR FELT

Cleaned and sterilized cattle hair can be felted into cushioning material for use as packing in shipping containers. Rolls of the felted material are manufactured in standard widths and in a range of thicknesses and densities. The material is average in resilience, low in compression-set, has poor damping qualities and tends to disintegrate slightly so that it is dusty during use. It retains moisture and, unless it is specially treated, will readily act as a host to fungus. It tends to become acidic if subjected to prolonged moisture. Use should be limited to pads which can be glued in place to cushion large items using a protective barrier between the pads and the surfaces of the product.

B.11 EXPANDED POLYSTYRENE

Expanded polystyrene retains its desirable characteristics including good temperature insulating properties and shock absorption properties. It comes in sheets which are uniform in both quality and texture, and can be cut into almost any desired shape. If the surface of the product is highly polished or finished, a soft protective sheet between the cushion and the product may be desirable.

It is especially suited for packaging where a high degree of energy absorption and temperature insulation are required (particularly at extremely low temperatures), and it does have good tensile strength. Since some liquid chemicals will cause it to dissolve, it is best used with dry products unless compatibility of the material with the specific liquid has been established.

Basically, expanded polystyrene is best used for support, suspension, or mounting blocks or molds. Padding on the corners of merchandise to fill the eight internal corners of shipping containers will reduce contact between product and carton surface.

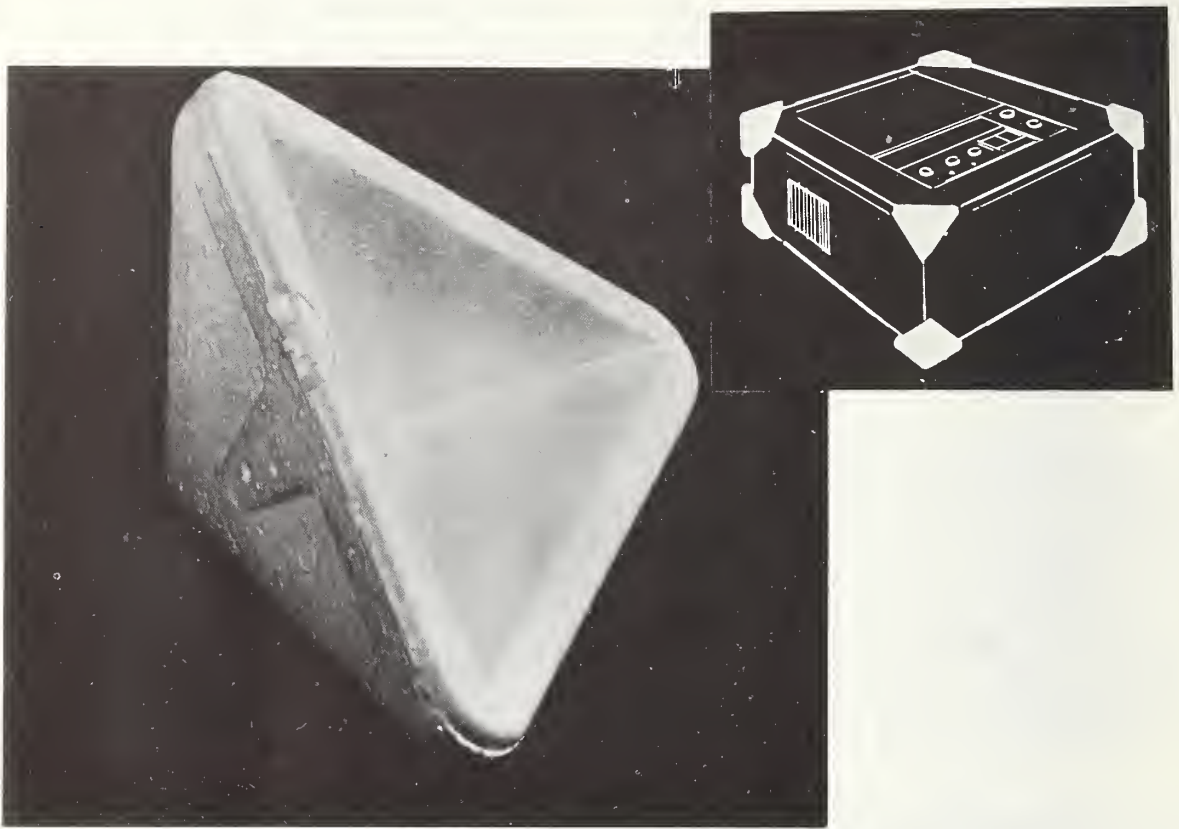

(Courtesy, Dow Chemical Co.)

Figure 32. Polystyrene corner pads.

B.12 CUSHIONED WRAPPING

A relatively inexpensive cushioned wrapping with many applications is made from one or more plies of paper pulp which has been corrugated, nodule indented, or simply formed into a solid molded sheet. These various forms may or may not have a backing sheet of unbleached paper. In its corrugated form, it is distinguishable from corrugated fiberboard in that it has paper backing on only one side.

As with many other types of packing materials discussed in this Chapter, cushioned wrapping can be used to immobilize irregularly shaped objects without much increase in bulk since its flexibility allows it to conform well. Although it gives only moderate protection to the items it surrounds, it is easy to apply and requires only a modest amount of room for storage since it comes in rolls and a wide variety of flat sheet stock. It readily absorbs moisture which may cause the wrapping to release corrosive chemicals and/or which may become subject to fungus growths. It is not fire-resistant unless it has been specially treated.

Cushioned wrapping provides some shock absorption, good protection for the surface of the product within the container and separation from other units within the same parcel. It has very low resilience. When cushioned wrapping is used in packaging, it should envelop an item completely and have the ends folded over to give additional protection.

Latex coated cushioned wrapping offers special convenience. The latex coating on a single-faced cushioning wrap is so designed that when the wrap overlaps, as at a seam, it will stick to itself. The packer has only to squeeze the material together to form a substantial seal on every side. The latex will stick only to itself, not to the goods enclosed.

The diagram in Figure 33 (next page) shows the steps in using cushioned wrapping. It should never be used as an external container when an item requires a strong external container.

B.13 PLASTIC FOAM SHEETING (POLYPROPYLENE)

Small, air-filled cells with thin, flexible walls make polypropylene one of the lightest plastics. The resilience of these air-filled cells make it well suited for shock protection.

As a plastic it has many practical advantages: It is light-weight and low-cost, it clings to fine surfaces without being abrasive, it has good elasticity and resistance to most chemicals, it is a reasonably good barrier against moisture and gases, and it offers good protection against dust and other contamination. It does become brittle when exposed to low temperatures but it can be blended with polyethylene or other substances to improve its resilience at lower temperatures.

The great flexibility of polypropylene renders it particularly effective as an internal wrapping medium. It can be folded and squeezed to protect sharp corners on the merchandise and crumpled to fill empty spaces inside the container.

The pictures in Figure 34 illustrate the wrapping of a glass vase in polypropylene sheeting. The shipping container is first lined with the plastic sheeting. The vase is then wrapped with the material and held with pressure-sensitive tape. In the final picture the wrapped vase is placed inside the lined box. Extra material is finally folded over to fill any remaining voids. Relative motion within the package is restricted to the minimal amount that may occur between the merchandise and the plastic sheeting.

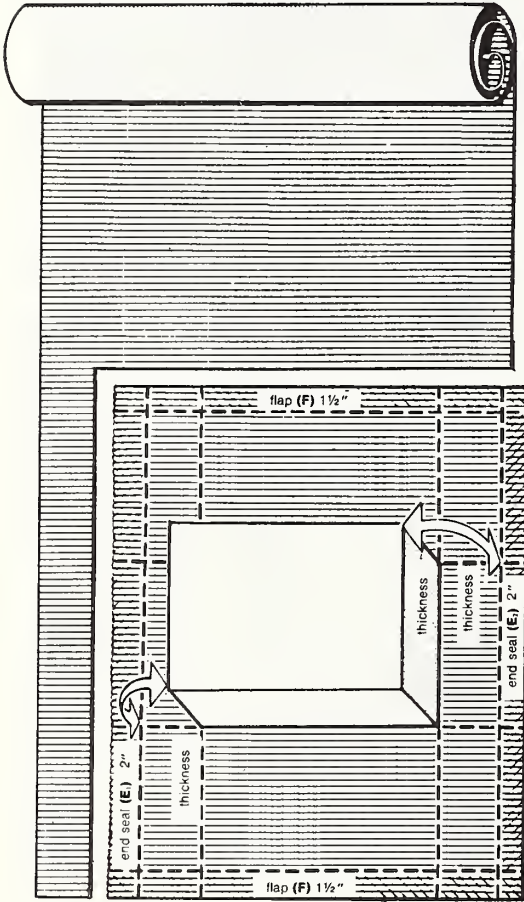

1. Measure

Unroll the wrap with the ribbed self-sealing side up. Position the object so that you can fold the material completely around the object. Allow an extra 1 1/2" at each end, to create a sealing flap (F). To measure for width, move the article toward one edge of your cut piece, allowing a margin that is equal to the thickness of the object; also add about 2" for the end seal (E). Measure the same way on the other end, again adding 2" for sealing. Mark all the cutting points carefully.

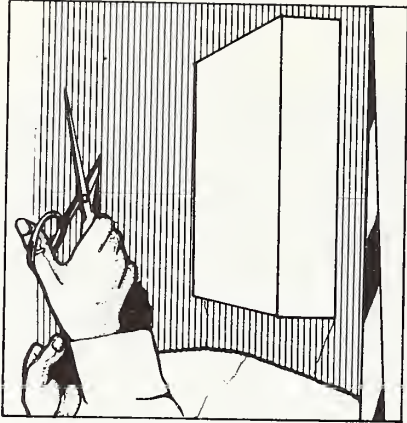

2. Cut



4. Seal

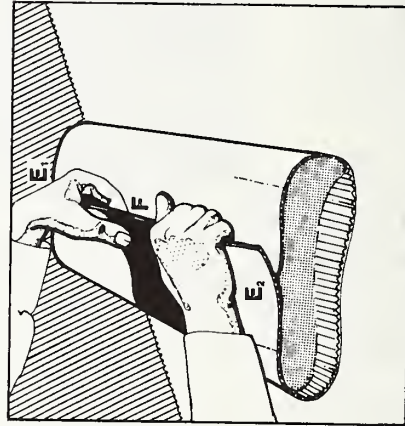

3. Wrap

(Courtesy, Marketplace International)

Figure 33. How to use self-sticking, single-faced, corrugated wrap.



(a) Container is lined with polypropylene foam sheets.



(b) Polypropylene is cut to fit and wrapped around vase.



(c) The wrapped vase is taped



(d) The wrapped and taped product is placed in the lined container.

(Courtesy, Du Pont Co.)

Figure 34. Wrapping a glass vase in polypropylene sheeting.

B.14 LOOSE FILL

This term is applied to any material that comes in shredded or small unit form that can be dropped into a shipping container to fill empty space. Loose fill is convenient and highly adaptable but it does not equal nor should it supplant custom packaging for delicate items.

Types of Loose Fill:

- (1) Shredded Paper. Many types of paper can be shredded in either long or short strands to make loose fill. Most of these papers have the same general characteristics unless they have been treated to serve particular purposes.

Waxed, shredded paper is one of those in the special treatment category. A cellulosic fiber material coated with a wax has high compression-set and low resilience, limited shock protection, and low moisture content. It has good temperature performance but low resistance to fungus and molds, tends to exude dust from partial disintegration under abrasion, and cannot be used against certain metal surfaces without an intervening neutral wrap. Shredded newspaper is mostly used to restrain items inside containers.

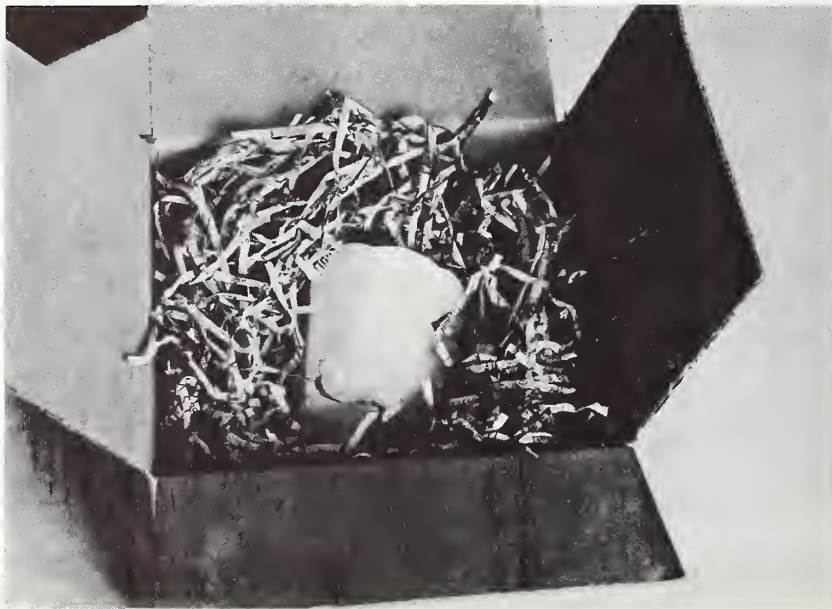

Figure 35. Shredded newspaper used as loose fill.

- (2) Excelsior. Shredded, straight-grained soft wood, free of mold, decay or pitch, is sold both in bulk and in pad form under the trade term of excelsior. Bulk excelsior is available in several grades from "wood wool" to coarse or shreds; pads may be obtained in various weights from light to extra heavy.

Excelsior has its own peculiar characteristics: high compression-set, medium resilience, and excellent vibration damping qualities. Moisture content and absorbency are high and the corrosive effects are considerable because of the presence of organic acids. Excelsior has poor fungus resistance, is highly flammable, and has poor performance at very low temperatures. It yields a significant amount of dust, and, if the moisture content gets too low, the material can disintegrate into fine particles. Excelsior is abrasive and should not be used against any surfaces which might be damaged by scratching.

Excelsior is best used as a cushioning layer between the walls of an inner and an outer container, with a water-proof cover over the inner container. The finer grades of excelsior are intended for cushioning light, fragile goods; coarser grades are best adapted to cushioning rugged items.

- (3) Expanded Polystyrene Loose Fill. Polystyrene plastics are first extruded and then expanded to form small, extremely light-weight, low-density units for use as loose fill. Strands, stars, saddles, rings, and other free-form shapes will fill empty space around the products in a shipping container with bulky but almost weightless packing. The plastic units are economical to use, particularly when a mailer has a broad line of products.

Polystyrene forms are water resistant, not subject to fungus growth, non-abrasive and dust-free. Many products packed in them do not need pre-wrapping. The forms can be fed into the shipping carton from an overhead, hopper-dispenser system for rapid package preparation.



(Courtesy, Dow Chemical Co.)

Figure 36. Polystyrene loose fill.

- (4) Coated Fibrous Glass. Glass fibers may be matted together, bonded or otherwise treated to produce loose fill cushioning. This material has high resilience, low compression-set, no corrosive effects, low moisture content and absorbency, fungus-resistance, and good performance at low temperatures. Only coated glass fibers should be used since uncoated material readily pierces human skin, broken bits become airborne and breathable, and it is abrasive to finishes.

Packing With Loose Fill:

Methods of packing with loose fill are much the same regardless of which of the fill materials described above is used. The following procedures should be observed:

- (1) Cover the entire bottom of the shipping container with a generous layer of loose fill;
- (2) If necessary, wrap merchandise in dust proof or abrasion-resistant paper or plastic (use a waterproof cover if excelsior is used);
- (3) Put the goods in the center of the carton, leaving some space between units if there is any danger of their damaging each other;
- (4) Drop loose fill between and on all sides of the merchandise units and over the top, allowing for 3 inches of fill between contents and any inner surface of the container;
- (5) Over-fill the container by 1/2 to 1 inch so that closing the top will make the pack firm and hold the goods in position.

See Figure 37 (next page) for illustration of the use of loose fill.

B.15 WADDING

Wadding is made of cellulosic material and certain plastics commercially produced for packing. Commercial wadding is normally supplied in roll, sheet, strip, or perforated form, but it may be modified in several ways.

- Backing. Papers, foils and film may be laminated to the wadding to add strength, improve taping, ease handling, lend dimensional stability or to provide a moisture barrier.
- Facing materials such as facial tissue or gauze may be applied to the wadding to add softness or strength.
- Impregnation. Scents, oils, fire-retardant or antibacterial chemicals, rust preventives and other similar materials may be used to impregnate wadding as they are appropriate.
- Compressed. Wadding is available in longitudinally compressed for at a five-to-one ratio and easily expands to its original form.
- Density. Wadding is available in different densities and resiliencies for various packaging needs.
- Neutrality. Cellulose wadding can be produced for the packaging of silver, for medical purposes, or it may be made chemically neutral.

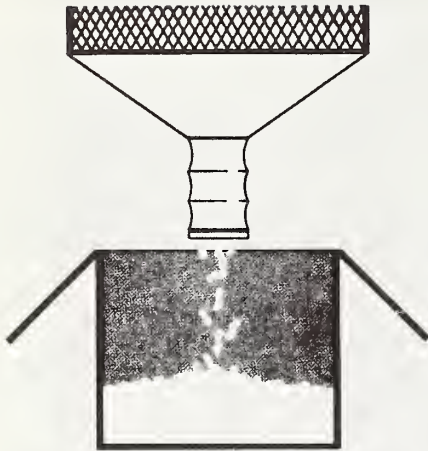

1. Dispense a layer of loose fill in the bottom of the box. If the application is critical, be sure the proper thickness for adequate protection is used.

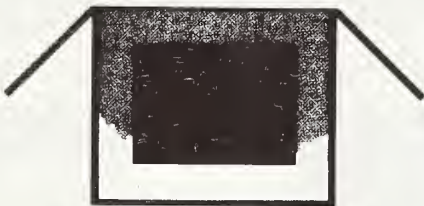

2. Place the item to be packaged on the bed of loose fill.



3. Fill side voids with additional loose fill.

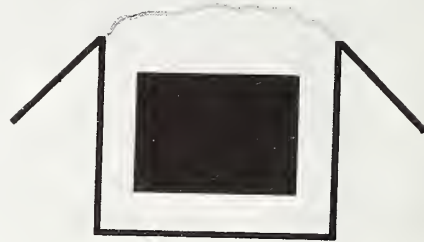

4. Fill the remainder of the carton or container to an excess.



5. Press down firmly to close. Cushioning material will interlock. Then seal the carton.

Figure 37. Packing with loose fill.

(Courtesy, Dow Chemical Co.)

- Embossing. Multiple plies of wadding may be embossed (have a design pressed in) to hold the plies into workable units.

Types of Wadding:

- Cellulosic Wadding is made of cotton and other natural fibers bonded, felted or otherwise pressed together. As cushioning material, cellulosic wadding has high compression set and is fairly resilient but some types exude dust in significant quantities. Merchandise adversely affected by dust should first be wrapped or sealed unless dust-controlled wadding is used.

Cellulosic wadding may be either water resistant or water absorbent. When it is absorbent, it will either keep a package moist or prevent leakage from a broken container inside the shipping container. Some types are capable of absorbing up to 16 times their weight in water. Water-resistant wadding is not waterproof, and it will absorb and retain a certain amount of moisture within its fibers.



(Courtesy, Dow Chemical Co.)

Figure 38. Cellulose wadding protecting the contents of a mailing tube.

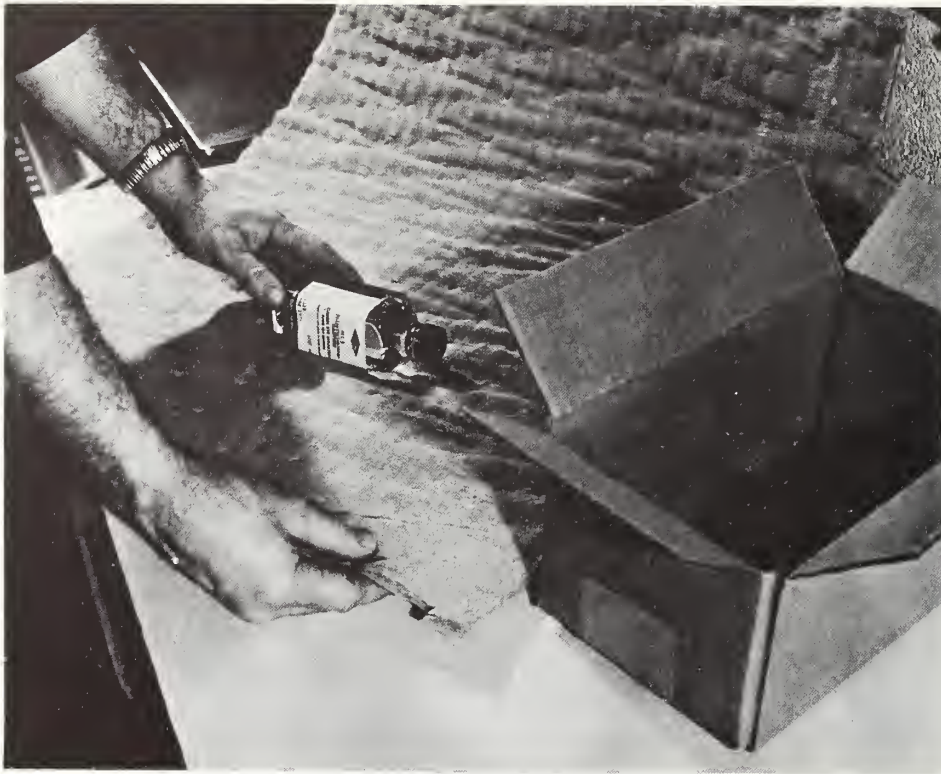

(Courtesy, Dow Chemical Co.)

Figure 39. Preparation for wrapping with cellulose wadding.

- Miscellaneous Wadding. Commercial mailers often use reclaimed recycled newspaper or kraft paper as wadding and may even purchase sheets or rolls of foam plastic or unsterilized cotton for packaging. Each of these materials has its special characteristics and limitations. In general, wadding pads must be thick enough to do cushioning job that is needed.

Wadded newspaper should not be crumpled too tightly or it will have no cushioning effect, nor too loosely or it will not retard movement within the box.



Figure 40. Use of crumpled newspaper as wadding. (NBS)

B.16 CORRUGATED AND SOLID FIBERBOARD

Both corrugated and solid fiberboard are widely used as impact absorbing materials. The corrugated variety is more common because it has greater cushioning value. Corrugated fiberboard also serves as one of the primary materials for blocking and bracing. The fiberboard chosen should be compatible with the load to be supported, as well as with the size and shape of the item. Those surfaces of the corrugated cell or tray which are perpendicular to the contacting surface of the merchandise are the load-bearing members. Brief descriptions are given below of several types of fiberboard interior packing material and their uses.

- Open-end Cells and Trays. Cells and trays should be held in shape with tape or adhesive. Open-end cells and trays are used for blocking or bracing deep recesses; bridging long projections; and giving clearance between the product and its container.

- Folded Pads. Folded pads of corrugated fiberboard will block greater loads than can be supported by cells or trays. The pads should be designed to fit against a flat surface (flat pads) or along an edge (edge pads) of the merchandise. Accordion-folded pads of corrugated fiberboard have greater resistance to collapse than open-end or columnar cells of this material because the load is spread over a larger area and the weight is distributed more evenly on the walls of the container. Increasing the number of pleats does not increase the load limit of the shipping carton. Wide or long items are better supported by several accordion-folded pads placed side by side than by one pad having extra-wide, folded pleats.
- Flat Pads. Flat pads of corrugated fiberboard will block very shallow projections and slight offsets on surfaces; fill the space between the ends of inner flaps of slotted fiberboard boxes; provide additional protection to contents at the top and bottom of boxes; and, separate items within a container. Flat pads can be slotted to form partitions or they may be die-cut or punched to fit items of irregular shape.
- Corrugated Liners. Corrugated liners will reinforce a container or take the place of one or more flat pads and are usually made of a continuous piece of fiberboard which supports the sides and ends of a box. Liners should be made of the same strength material as the box and should be as tall as the product being packed.
- Corner Pads. Corner pads cushion and protect the corners of square or rectangular goods. Specific sizes and kinds of pads are often designed to shield particular items.
- Corrugated Fiberboard Partitions. When multiple products are packaged in one external mailing container, partitions should be used inside to hold each product in its own individual, snug-fitted section made of material that is equal in strength to that of the exterior box.

C. CLOSURES

Closures are an important link in the chain of procedures necessary for packaging adequate parcels. Unless an appropriate closure is correctly applied, a container will be subject to damage in any shipping environment. This section will cover the basic means of closure and methods of application to various types of containers. Basic closures (adhesives, staples, stitches, tapes, ties, strapping/banding, and tops or closures for tubes and cans) are discussed in this section.

C.1 ADHESIVES

When a suitable adhesive is spread on one or both of two surfaces, it solidifies and bonds the two surfaces together when they are brought into contact. A suitable adhesive exists for sealing each type of material, whether it be fiberboard, paper, wood, or plastic. When adhesives are used for closure, the container is usually damaged upon opening so that it cannot be reused.

The mailer must consider two important factors when choosing adhesives for parcel closures: reaction to temperature and humidity changes; and compatibility with the materials on which they are to be used.

There are three general types of adhesives:

(1) Starch-Derived Adhesives (Paste)

Dextrins are the only starch-derived or vegetable adhesives which are used for shipping. These adhesives are water soluble, but if treated, will not dissolve in organic solvents. They are generally used for paper-to-paper bonding. To improve adhesion, setting speed, and economy, the dextrins are often compounded with borax, but these combinations tend to be stringy and to require stencils or transfer rollers for proper application.

(2) Protein-Derived Adhesives (Glue)

Protein-derived adhesives are soluble in water but insoluble in organic solvents. Dried films exhibit good strength and adhesion on "difficult" paper stocks such as waterproofed, waxed, plasticized, oiled, inked, and varnished papers. There are two primary protein-derived adhesives:

- Liquefied Animal Glues are fluid at room temperature. Their other properties vary widely depending on use. Iceproof gums, for example, are formulated to jell in cold water and hold labels on bottles. Other animal glues are intended for use as remoistening gum. Liquefied animal glues can be used for wood gluing or make-ready adhesives in manufacturing and closing of folding boxes.
- Casein. As an adhesive, casein ranks moderate to high in water resistance. Some types require ammonia or alcohol as a diluent but dried films are usually soluble in alkaline solutions and are very strong. Casein is generally used in case sealing.

(3) Synthetic Resin Adhesives (Cements or Thermoplastics)

There are four general types of synthetic resin adhesives with very different properties and uses:

- Emulsions are outstanding for their final adhesion; fast-setting qualities; and their resistance to humidity, grease, and mold. Highly water-resistant films may require solvents for removal but some types are water dispersible for easy cleaning. Emulsions are used in case and carton sealing, in folding box and paper bag seams, and in sealing.
- Latex Adhesives are usually used in foil-to-paper lamination, polyethylene bags, labels for inked and varnished surfaces, case-liner fabrication and sealing, water-resistant drum and container labeling, self-sealed bag and container closures, pressure-sensitive coatings for cards used on plastic containers, and for padding.
- Solvent Activators consist of solvent-plasticizer combinations that dissolve or fuse plastic film and make it adhere. Although some solvent activators are flammable, others can be used with heat sealing to improve bonding.
- Hot Melts must be heated until liquefied before use. Hot melts are used as heat-sealed coatings for board stocks in blister and skin packaging, and for case and carton sealing. They permit quick sealing of materials with resultant low permeability to water or solvents.

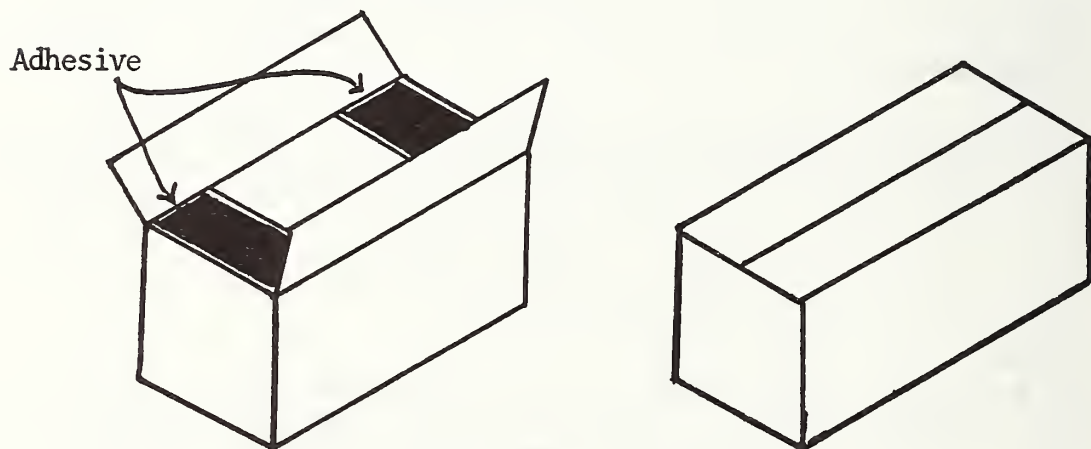

Figure 41. Proper adhesive application for a regular slotted container. Note that 75% of the surface area of contact is covered with adhesive, and that the inner flaps and scorelines are covered to within 1/4 inch of the edges with adhesive.

POINTS TO REMEMBER WHEN USING ADHESIVES

1. Make sure the adhesive is applied to prevent lifting of the edges in handling.
2. Allow sufficient drying time while maintaining enough contact pressure to form the proper bond.
3. Make sure the adhesive selected is recommended for the packaging material. Many containers are treated to repel water, grease, or both.
4. The adhesive should cover 50-75% of the overlapping area depending on the type of container.
5. Apply an adequate coating of the adhesive. A thick film is generally stronger than a very thin one.
6. Take special care with glossy surfaced shipping containers. Such surfaces sometimes cause problems in adhesion.
7. When using plastic containers, be sure the adhesive is appropriate to the type of plastic involved.

C.2 STAPLING AND STITCHING

Staples are preformed U-shaped, round, or flat wires that secure parts of a container together. They are usually applied with a "gun", hammer, or automatic machine. Staples are not seriously affected by environmental conditions such as moisture or temperature extremes. They can be used to close bags, sacks, envelopes and fiberboard containers. (Regular office-type staples should not be used to close a cushioned bag.) The mailer is encouraged to use heavy-duty staples and to place pressure-sensitive or gummed kraft tape over all staples for added protection to the closure, postal personnel, equipment, other parcels, and to the addressee. Staples come in various styles:



- (a) Conventional Size Staple. Has 1/2 inch crown (head) and is used with corrugated, chipboard, or paper container materials. Always clinched.



- (b) Wide Crown Staple. Applied with retractable clincher arms which penetrate carton flaps. It staples single, double, or tri-wall corrugated.

Figure 42. Two types of staples.

Stitching refers to the formation of a wire fastener similar to the staple from a continuous coil of wire. Like staples, it is not seriously affected by moisture or temperature extremes. Stitching may be used to close bags, sacks, envelopes, and fiberboard containers.

POINTS TO REMEMBER WHEN USING STAPLES OR STITCHES

1. Staples can be hazardous if they are improperly applied or loosen during handling. They can scrape or mar equipment, snag clothes, or injure employees. Staples should be covered with tape after clinching to prevent loosening and possible injury to personnel.



(NBS)

Figure 43. A potential hazard in the mailstream created by improper application of a staple.

2. To be effective, staples and stitches should pass completely through at least two thicknesses of container material, penetrating both inner and outer flaps.
3. Staples and stitches can only be used with containers which are strong enough to support them.
4. If package contents can be harmed by exposure to foreign matter such as dust or moisture, do not use staples or stitching unless a secondary closure such as tape is also applied to seal the openings.

When a regular slotted container is being closed, the outer bottom flaps can be fastened with stitches or staples. The stitches/staples should pass through all of the flaps to be fastened and should be clinched on the inside of the box, drawing the flaps firmly together. Stitches/staples should be evenly distributed over the areas where the outer flaps meet and overlie the inner flaps, and should be spaced not more than 2 1/2 inches apart along the edges of the outer flaps. If the gap between inner flaps is more than 5 inches, tape should be used over the meeting of the outer flaps. Stitches/staples should be placed not less than 1/2 inch, nor more than 1 inch from the lengthwise edge of the outer flaps, and not more than 1 1/4 inches from the end-edges or scores of the flaps.

Metal stitches or staples

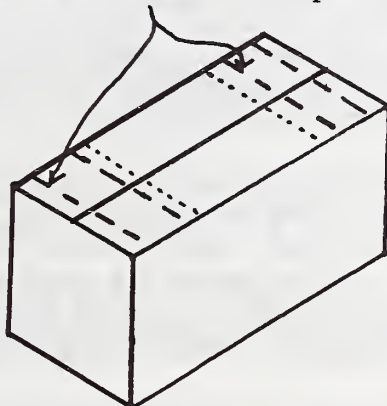

Figure 44. Stapling or stitching the bottom closure of a regular slotted container. (Dotted lines mark the hidden end-edges of the inner flaps.)

When the outer bottom flaps of an overlap flap container are closed by stitching/stapling and the inner flaps have more than a 3 inch gap, additional stitches or staples should be applied approximately every 2 1/2 inches, in a row parallel to and approximately 1/2 to 1 inch from the long edge of the visible outer flap, for the full length of the gap.

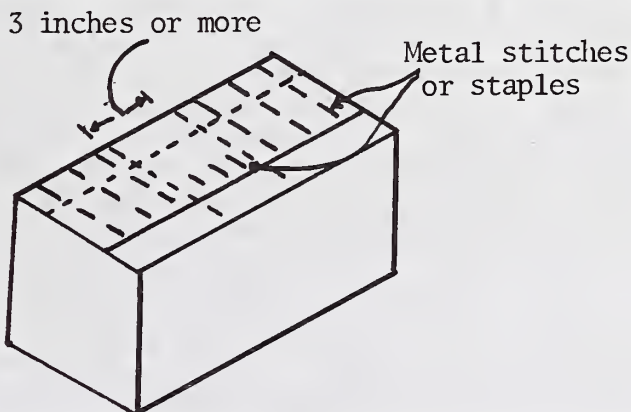

Figure 45. Stapling/Stitching the closure of an overlap flap container. (Dotted lines indicate the position and extension of both the inner flaps and the partially hidden outer flap.)

C.3 TAPES

Tape can be generally described as a bonding agent plus a backing material. The performance characteristics and recommended methods of applying tapes vary widely depending on the bonding agent and the composition of the backing. Performance characteristics can also change over a prolonged period of time in storage or in use.

Any tape can be generally characterized in terms of three factors:

- Bonding agent: Whether it is gummed or pressure-sensitive.
- Backing composition: Whether it is reinforced or nonreinforced.
- Backing material: Whether it is paper, plastic, or cloth in basic composition (reinforcing materials are usually different from the basic backing material).

The discussion of tapes in this section is organized around the two major bonding agents (gummed tapes in Section C.3.1, and pressure-sensitive tapes in Section C.3.2) and, within those discussions, commonly used backing compositions, backing materials, and applications are presented. Tapes can be used as closures, and as reinforcing or sealing agents. Section C.3.3 illustrates several applications of tapes.

C.3.1 Gummed Tapes

Gummed tapes always require a wetting agent for application. They are most often activated by water, but some require a solvent to be added to the water. When properly selected, moistened, and applied, gummed tapes can provide excellent protection. Backing materials for gummed tapes are either paper or cloth, and gummed tapes may be either reinforced or nonreinforced. These tapes come in rolls containing 300-800 feet of tape and come in widths ranging from 3/4 inch to 4 inches.

Gummed tapes require more careful storage than pressure-sensitive tapes. Rolls of gummed tape should be kept in their original containers and the containers should always be closed when the tape is stored. They should be kept at normal room temperature and at a relative humidity of between 25% and 60%. This means they should be kept away from heat sources such as radiators, and away from sources of moisture such as open windows. When storing gummed tapes, the mailer should plan his storage so that the oldest tapes are always used first.

To assure adequate sticking the mailer should follow certain guidelines when using dispensing equipment for gummed tapes. The water level in the dispenser should be high and the water should be clean. Ideally, soft water should be used. If the water has high mineral content, a water softening chemical should be added. The proper activator, if necessary, should be added to warm water. The dispenser should be checked to be sure that the tape contacts the rollers, and worn brushes should be replaced promptly. Always keep brushes, rollers, and water tank clean. They should all be checked daily and cleaned as soon as they become soiled or clogged with paper, dust, or adhesive.

POINTS TO REMEMBER WHEN APPLYING GUMMED TAPES

There are certain points to remember when applying gummed tapes regardless of whether they are paper or cloth and whether they are reinforced or nonreinforced:

1. Apply an adequate amount of wetting agent and spread it evenly on the tape.
2. When placing the wetted tape on the container, apply pressure along the whole surface of the tape to be sure it adheres securely. (Gummed tapes set quickly.)
3. The surface to which the tape is being applied must be clean. If the container has been used before, all old tapes or other materials must be removed so that the gummed tape will stick directly to the container.

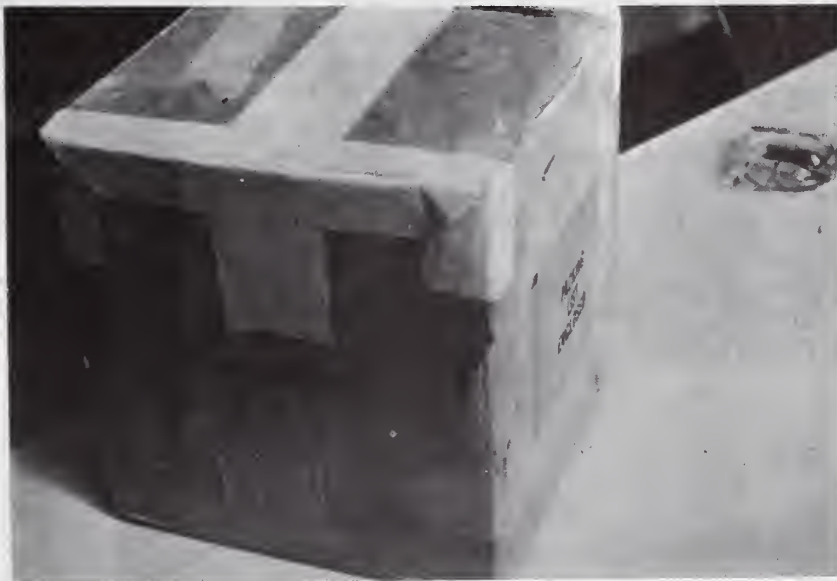
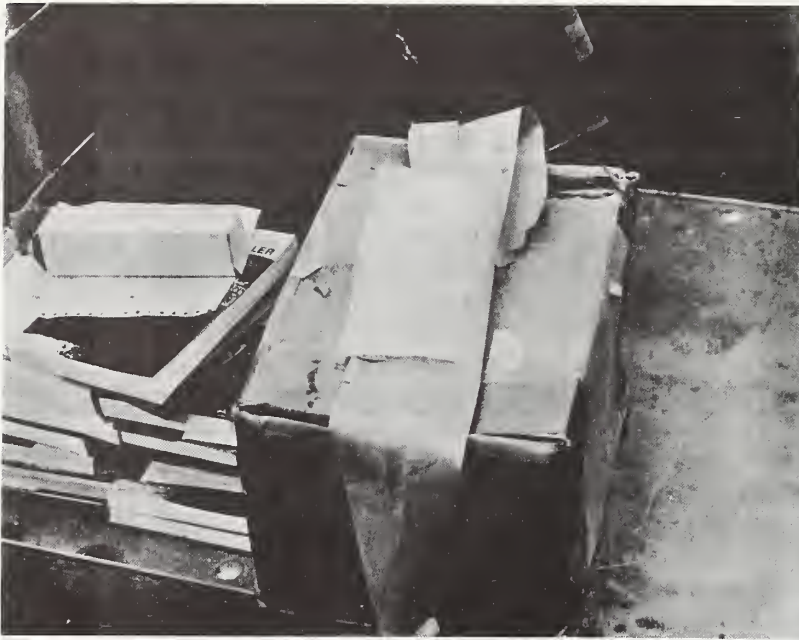

Figure 46. Taping a reused container.

(NBS)



(NBS)

Figure 47. Results of improperly wetting and applying tape.

(a) Gummed Tape: Nonreinforced (Paper)

Nonreinforced gummed tapes should be used only on light packages (under 20 pounds). The most commonly used nonreinforced gummed tape in use is paper backed, but some cloth tapes are also available. When used as primary closures for parcels in the Parcel Post system, nonreinforced gummed tapes should have a tensile strength of at least 55 pounds per inch, and an adhesion of at least 60 ounces per inch.

Nonreinforced gummed paper tapes are very commonly used in packaging parcels. The mailer must be sure, however, to use these tapes only on light packages. In addition, the proper tensile strength and width of tape must be used. Large parcels closed with nonreinforced paper tape, and parcels closed with improper strengths and widths of nonreinforced paper tape have a high damage rate in the Parcel Post system.

(b) Gummed Tape: Reinforced (Paper)

Reinforced gummed tape has a higher tensile strength than regular gummed tape and can be used to close most types and styles of containers. The reinforcement is provided by gluing glass, rayon, or sisal fibers between two layers of paper. (See page 37, Chapter 2, for illustration of three basic patterns of reinforcement.)

Heavy parcels (over 20 pounds) can be closed with reinforced gummed tape. It should have a tensile strength of 200 pounds per inch and an adhesion of 55 ounces per inch.

On a cost per inch basis, reinforced tape costs more than regular gummed tape, but because less tape is necessary per parcel, reinforced tape is more economical to use.

POINTS TO REMEMBER WHEN APPLYING REINFORCED GUMMED TAPES
<p>The same rules should be used as for gummed tapes in general:</p> <ol style="list-style-type: none">1. Apply adequate wetting agent and spread it evenly.2. Apply adequate pressure to be sure the tape sticks securely.3. Be sure the surface is clean and free from old tape. <p>In addition, for reinforced gummed tapes,</p> <ol style="list-style-type: none">4. Use tape with a tensile strength of 200 pounds per inch and an adhesion of 55 ounces per inch.5. Use tape at least 2 inches wide.6. After sealing the center seam with tape, lap the tape at least 3 inches over the adjoining faces as shown in Figure 50.

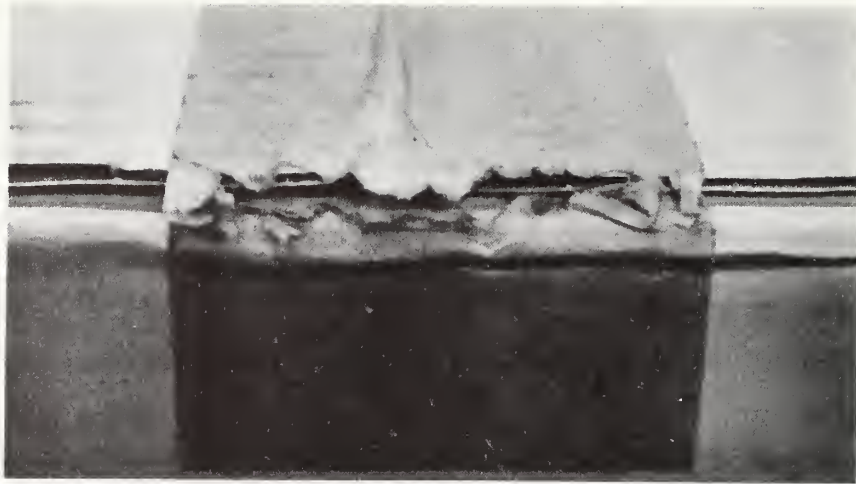

(NBS)

Figure 48. Ruptured nonreinforced gummed tape on a parcel where end closing strips were not applied.

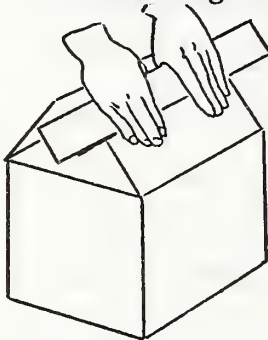

1. Apply first strip to far flap, then close flaps and seal center seam.

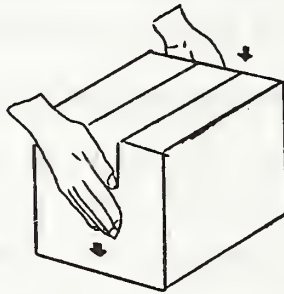

2. Press down overlap on ends (3 inch overlap on each end.)

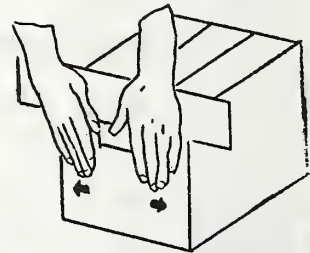

3. Seal edge seams with 3 inch overlap beyond corners.

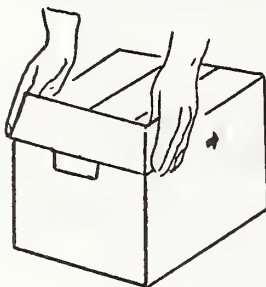

4. Bend around sides and pull tightly into position.

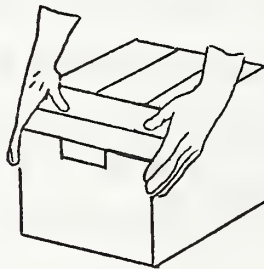

5. Fold corners over the top and press firmly, then fold and press top.

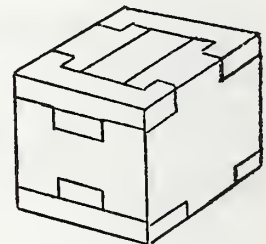

6. Repeat steps 3, 4, and 5 on the other end of the box.

(Courtesy, Gummed Industries Assn.)

Figure 49. Applying nonreinforced gummed paper tape and nonreinforced paper or cloth pressure-sensitive tape. All of these steps are required by Postal Service regulations for these tape closures.

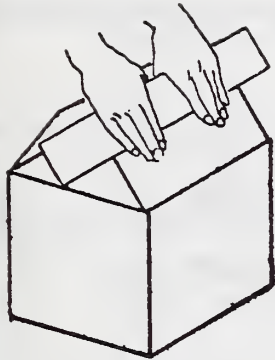

1. Apply one strip of tape, at least 2" wide, to far flap. Overlap 3" on each end.

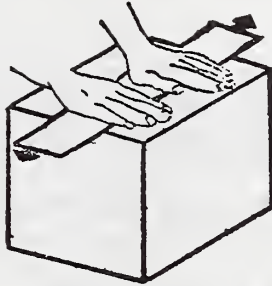

2. Close flaps and seal center seam.

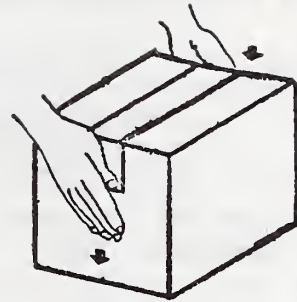

3. Fold down and press overlaps on each end.

(Courtesy, Gummed Industries Assn.)

Figure 50. Proper method of applying reinforced gummed tape, and nonreinforced pressure-sensitive polyester plastic tape.

C.3.2 Pressure-Sensitive Tapes

Pressure-sensitive tapes are versatile, dependable, economical, easy to use, and require no wetting agents or heat to activate the adhesive. The mailer must be careful to use pressure-sensitive tapes designed for packaging. Regular cellophane and masking tapes should not be used as primary closures.

At room temperature, pressure-sensitive tapes require very little pressure to make them adhere instantly to a variety of surfaces. Nearly all adhesives for pressure-sensitive tapes are a combination of some elastomer or rubber and a resin. The resin provides adhesive power and the elastomer furnishes internal strength. These tapes can be used both as the primary closure for shipping containers and as reinforcement for closures or critical areas of boxes.

Backing materials for pressure-sensitive tapes include: paper, polyester, polypropylene, unplasticized vinyl, and cloth. These tapes come in reinforced and nonreinforced forms.

(a) Pressure-Sensitive Tape: Nonreinforced Paper or Cloth

Nonreinforced pressure-sensitive tapes made of paper and cloth are suitable for closing light packages (under 20 pounds) and for sealing edges. When used as primary closure, they should be at least 2 inches wide and should have at least 60 pounds basis weight. Other

nonreinforced pressure-sensitive tapes such as cellophane, masking, and freezer tapes should never be used as primary closures.

POINTS TO REMEMBER WHEN APPLYING PAPER OR
CLOTH NONREINFORCED PRESSURE-SENSITIVE TAPES

1. Use as a primary closure only for parcels weighing 20 pounds or less.
2. Use only tape at least 2 inches wide.
3. Use only tape with at least 60 pounds basis weight.
4. Use on both the center seams and the edge seams of the parcel, and overlap at least 3 inches on the adjacent face of the parcel. See Figure 49 for illustration.

(b) Pressure-Sensitive Tape: Nonreinforced Plastic

Polyester backed plastic tapes can be used for parcels weighing up to the maximum acceptable by the Postal Service. Tapes having plastic backings made of unplasticized polyvinyl chloride (UPVC) and polypropylene should only be used for parcels weighing 20 pounds or less.

Pressure-sensitive nonreinforced polyester tapes should be applied to the center seams of parcels as shown in Figure 50.

(c) Pressure-Sensitive Tape: Reinforced Filament

These tapes consist of a plastic film (usually polyester) backing and continuous filaments of glass, rayon, or polyester embedded in an adhesive. Lengths of high performance filament tapes (tensile strength of 250 pounds per inch and minimum adhesion of 25 ounces per inch) are most efficiently used in short "L" clips or longer "C" clips for reinforcing scorelines and other critical areas of boxes. (See Figure 51 for an illustration of "L" and "C" clips.) These tapes can also be used for primary closures.

When one of the following problems exists, pressure-sensitive filament tapes can be used for reinforcement:

- o When cartons burst open at the closure, one or more strips of filament tape should be put across the flaps.
- o When cartons burst at the end of a side seam and the primary closure stays intact, the application of one or more 4-6 inch strips of filament tape at critical points will usually hold the broken area.
- o When other kinds of tapes do not adhere well to the surface of the container because of a dusty or dirty surface encircling bands of pressure-sensitive filament tape will give the needed protection.

The adhesive characteristics of all varieties of tape can be checked by sticking them to a clean piece of corrugated fiberboard or paper. Adhesion is adequate if some of the fibers on the surface of the paper stick to the tape when it is pulled off.

Pressure-sensitive filament tapes can be used as primary closures for a variety of box styles, bags, cartons, and tubes. Fiber drums with telescoping covers can be sealed by putting a strip of this tape over the joint, and multi-wall bags can be made sift-proof by covering the primary closure with this tape.

When used for primary closure and reinforcement of regular cartons, pressure-sensitive filament tapes should be applied as shown in figure 51.

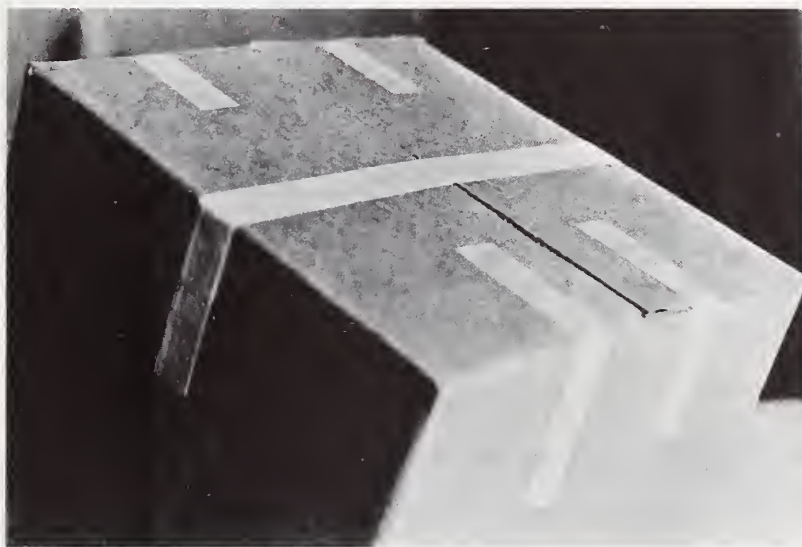

(NBS)

Figure 51. Pressure-sensitive filament tape used as carton closure and reinforcement.



(Courtesy, 3 M Co.)

Figure 52. Banding two parcels to form one parcel using pressure-sensitive filament tape.

C.3.3 Application of Gummed and Pressure-Sensitive Tapes

In this section, are pictures and descriptions of the proper application of various tape to close or reinforce some commonly used containers.

(1) Regular Slotted Container

Regular slotted containers should be closed with a relatively strong tape along the center seams. A pressure-sensitive plastic tape (must be at least 1.5 mil polyester if gross weight is over 20 pounds) should be two inches wide and extend at least three inches over the edge onto the box end panels as illustrated below. A reinforced gummed tape (must have tri-directional reinforcement if gross weight is over 20 pounds) should be three inches wide and extend at least three inches onto the box end panels.

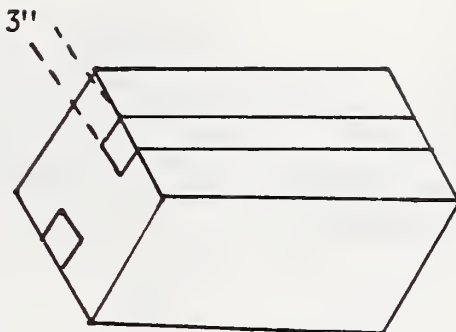

(NBS)

Figure 53. Application of gummed reinforced or pressure sensitive polyester on a regular slotted container.
(Polyester tape may be 2 inches wide.)

Gummed or pressure sensitive paper tapes should be applied in an "H" pattern on a regular slotted container, centered over the seam formed by the edges of the outer flaps and the end panels; tape strips should extend the full outside width of the box as shown in Figure 54. Gummed paper tape is not adequate for heavy packages.

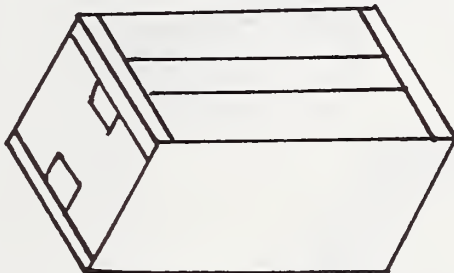

(NBS)

Figure 54. Application of gummed or pressure-sensitive tape on a regular slotted container.

For regular slotted containers longer than 24" which weigh over 30 pounds, the closure should be reinforced with a "C" clip of at least 1/2" filament tape, extending 3" or more down each side panel as shown in Figure 55. For boxes weighing over 40 pounds, "L" clips will be needed.

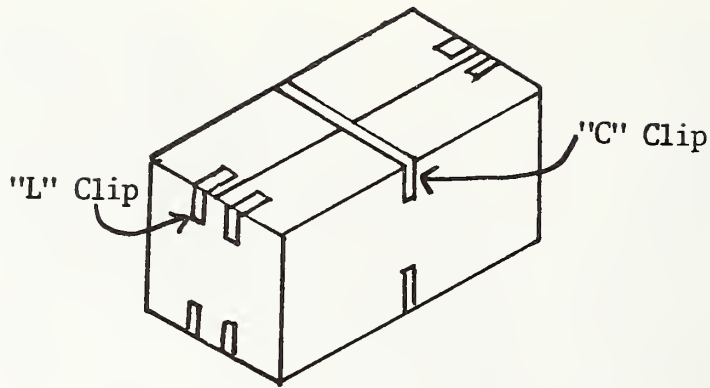

(NBS)

Figure 55. Application of filament tape "L" and "C" clips to close and reinforce a long and/or heavy box.

(2) One-Piece Folders

A one-piece folder carton should be closed along the open seams with two-inch wide pressure-sensitive or gummed paper tape or pressure-sensitive polyester tape as shown in Figure 56.

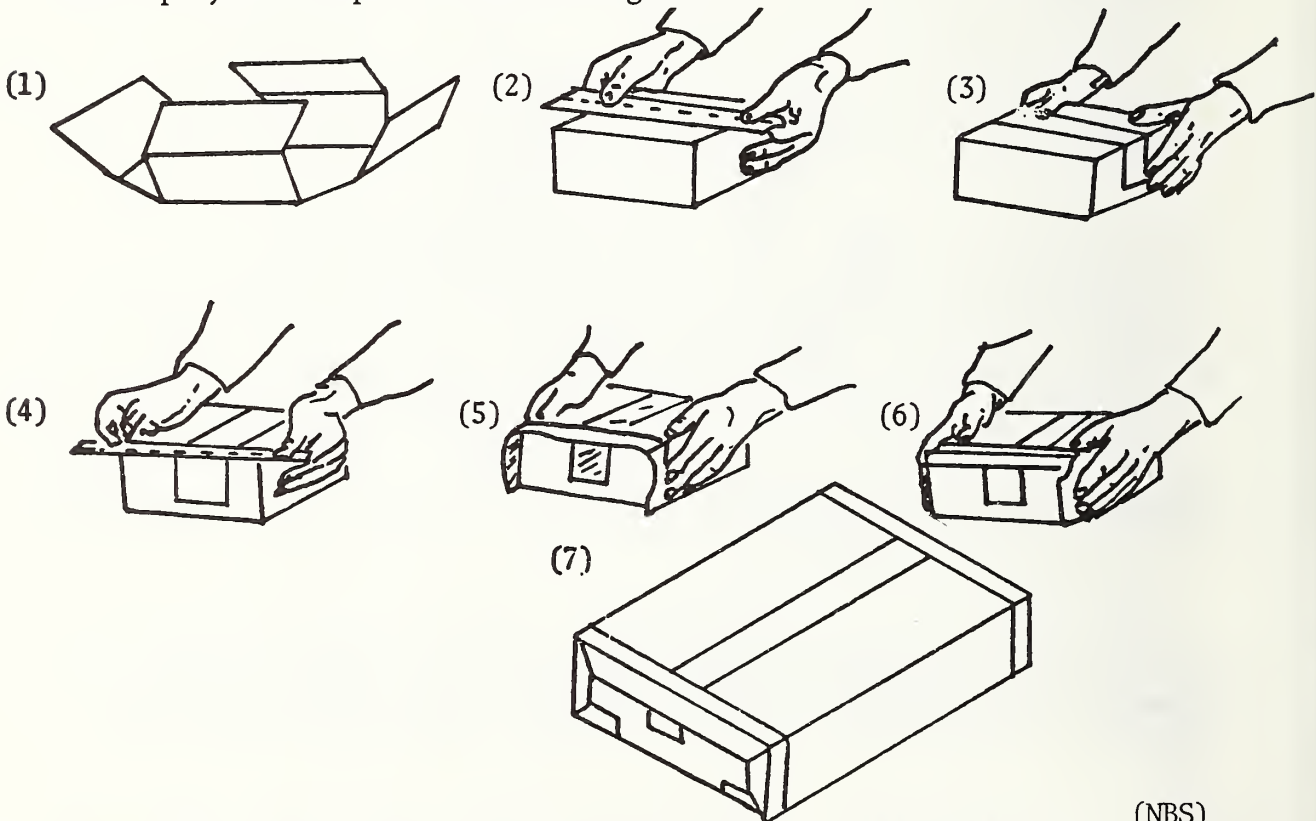

(NBS)

Figure 56. Application of pressure-sensitive or gummed paper tape, or pressure-sensitive polyester tape to a one-piece folder.

(3) Five-Panel Folders

Five-panel folders should be closed with either "L" clips of reinforced gummed or pressure sensitive filament tape, or with two inch wide paper or plastic tape. Reinforced gummed tape should be used in clips three inches wide by at least seven inches long (3.5 inch legs). Pressure sensitive filament tape should be used in clips a minimum of 1/2 inch wide by four inches long (two inch legs). Figure 57 illustrates the various applications.



Five Panel Folder

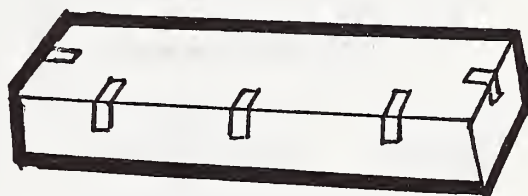

"L" clips of pressure-sensitive filament or reinforced gummed tape

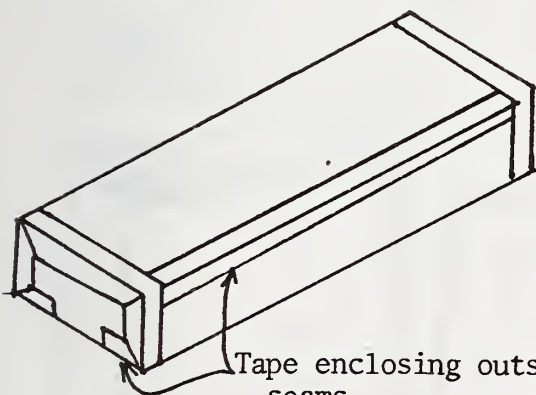

Paper or plastic tape



"C" clips of filament tape

(NBS)

Figure 57. Application of tape to a five-panel folder.

(4) Full Telescope Boxes

Full telescope boxes can be closed with "L" clips of pressure-sensitive filament tape or reinforced gummed tape as shown in Figure 58. Reinforced gummed tape should be used in clips three inches wide by seven inches long; pressure sensitive filament tape should be used in clips a minimum of 1/2 inch wide and four inches long.

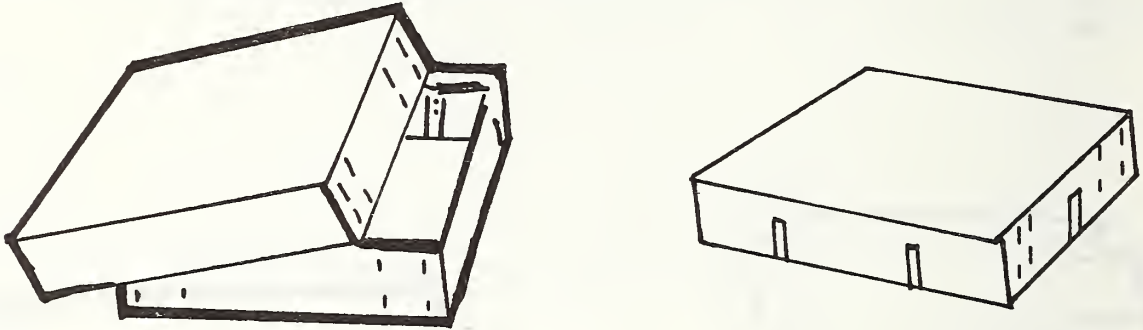

(NBS)

Figure 58. Full telescope box with "L" clip tape closure.

(5) Full Overlap Boxes

Full overlap boxes should be closed with "L" clips of pressure-sensitive filament tape or reinforced gummed tape as shown in Figure 59. Reinforced gummed tape should be used in clips three inches wide by seven inches long; pressure sensitive filament tape should be used in clips a minimum of 1/2 inch wide by four inches long. When the contents weigh up to 40 pounds, full overlap boxes can be closed with two-inch wide paper or plastic tape as shown in Figure 59.

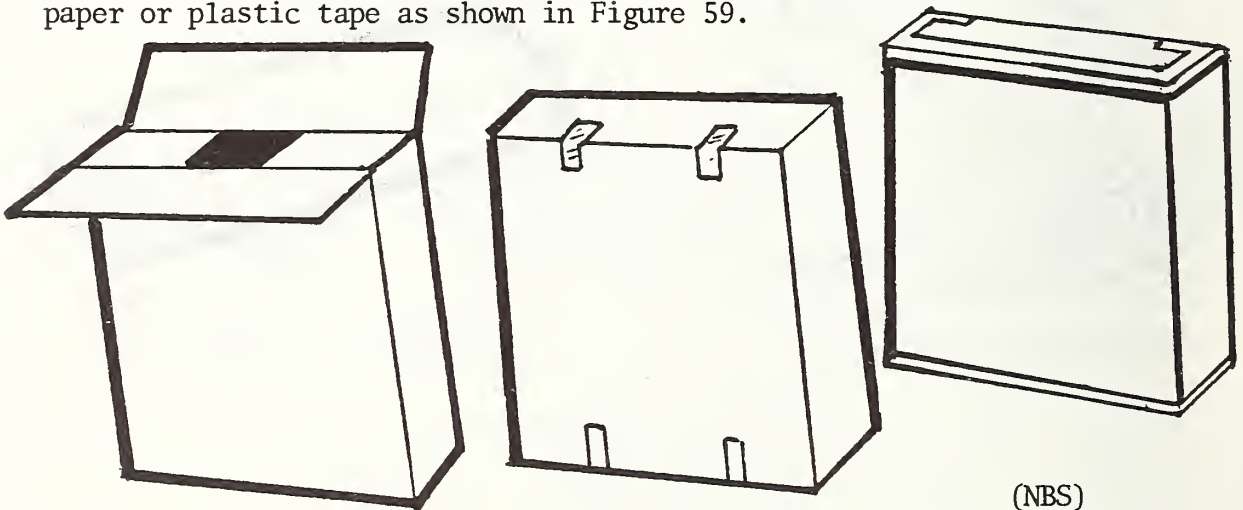

(NBS)

Figure 59. Full overlap box with pressure-sensitive or gummed paper tape closure.

(6) Paper-Wrapped Parcels

Close paper-overwrap with two-inch width paper or plastic tape as illustrated in Figure 60. When gross parcel weight is over 20 pounds, also apply complete bands of minimum 1/2 inch-wide filament tape in two directions around the container.

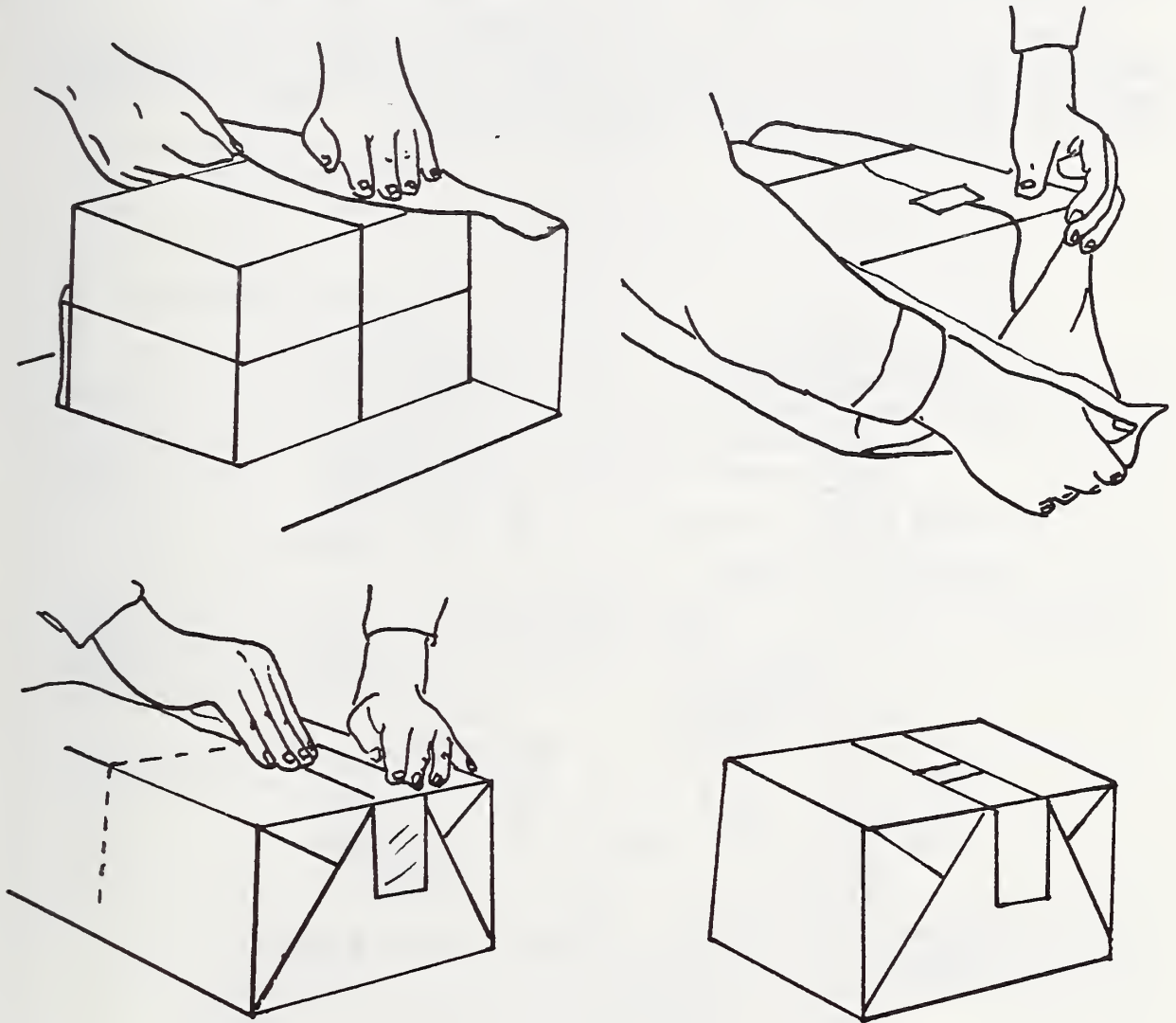

(NBS)

Figure 60. Application of tape to a paper-wrapped parcel.

C.4 TIES

Tying materials are available in many forms but the most common are twine, cord, and rope. Ties should not be used as the main closure since handling may cause knots to loosen or slip. Ties frequently stretch, slacken, fray, ravel, and break.

After a container has been securely closed with tape, staples, or adhesives, ties will enhance overall strength. The twine or cord employed should have a tensile strength of at least 20 pounds. Figure 61 illustrates the procedure for tying a parcel with twine.

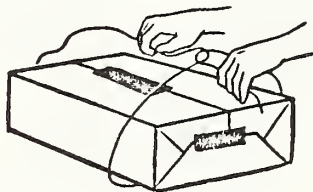

1. Loop twine around parcel as shown

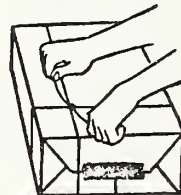

2. Tie a Knot

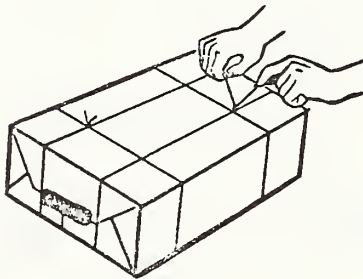

3. Repeat 1 and 2 as shown

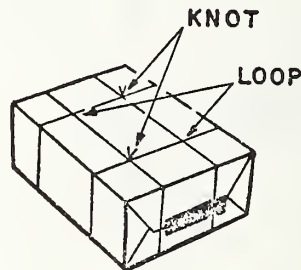

4. Completed parcel

(NBS)

Figure 61. Tying procedure.

POINTS TO REMEMBER WHEN USING TIES

1. Make primary closure with tape, staples, or adhesives.
2. Use strong twine, cord, or rope.
3. Tie as tightly as possible.
4. Make sure knots are secure.
5. Use enough turns around carton to give extra strength to the packaging.

C.5 STRAPPING OR BANDING

Strapping or banding can be used to reinforce crates and heavy cartons or to bundle several packages together, but they are not suitable as the primary means for closing a container. They often loosen during handling and processing. Steel and plastic, as described below, are two of the more common strapping or banding materials.

(a) Steel Straps

Straps of steel are dimensionally stable when normal tensions remain unchanged. The majority of containers found in the mailstream, however, are made from materials that can indent after steel strapping is applied. This causes loosening of the straps.

Steel strapping is available in a variety of widths and thicknesses. Steel has these characteristics:

- It is inexpensive in per-package cost.
- Long-term exposure to sunlight or moisture does not affect it.
- In heavy-duty form it will absorb large impact forces without breaking but it should be straddled with staples or filament tape to keep it in place under stressful conditions.
- Straps of wire or oval shape are more likely to damage container edges than flat steel.

Appropriate use of steel strapping is shown in Figure 62.



(NBS)

Figure 62. Appropriate use of steel strapping.

The size of strapping as a function of the gross weight of container and contents is given in Table 7. The numbers of lengthwise, girthwise and horizontal straps are based on the outside dimensions of the box. At least one girthwise strap should be applied to fiberboard boxes. Figure 63 illustrates the relationship between box dimensions and number of straps in pictorial form.

Table 7

STEEL STRAPPING SIZES (FLAT & ROUND)

Gross weight of container and contents	Size of flat steel strapping (in.)		Size of round steel strapping
	Nailless	Power Machine	
Pounds			Gage
Up to 35, incl-----	1/4 x 0.015 (in.) 5/16 x 0.012 3/8 x 0.010	1/4 x 0.015 (in.)	16
Over 35 to 70, incl---	3/8 x 0.015	3/8 x 0.015	15

LENGTH OF BOX DETERMINES THE NUMBER OF GIRTHWISE STRAPS

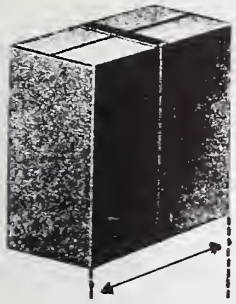

LESS THAN 20

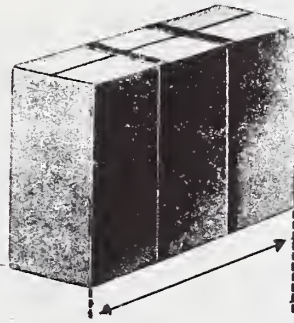

20 to 30

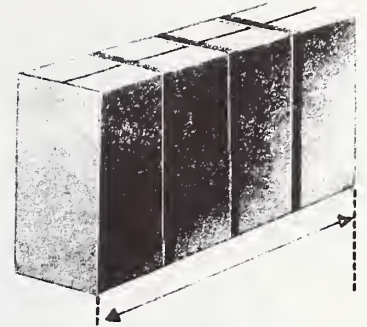

OVER 30 to 48

48 to 60—4 STRAPS
OVER 60—STRAP AS REQUIRED

WIDTH OF BOX DETERMINES THE NUMBER OF LENGTHWISE STRAPS

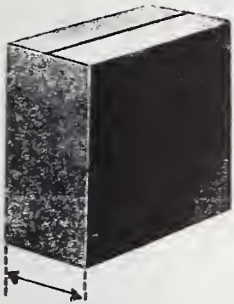

LESS THAN 9

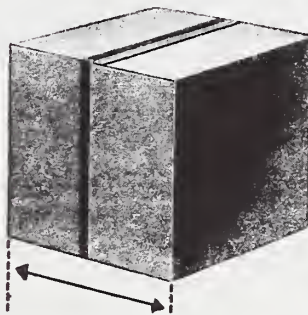

9 to 18

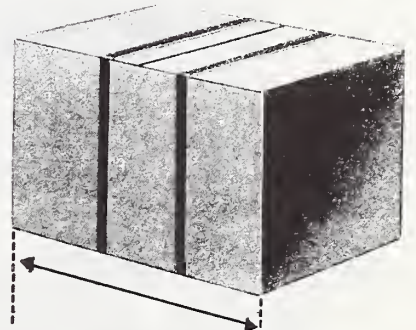

OVER 18 to 30

30 to 48—3 STRAPS
OVER 48—STRAP AS SPECIFIED

DEPTH OF BOX DETERMINES THE NUMBER OF HORIZONTAL STRAPS



LESS THAN 18

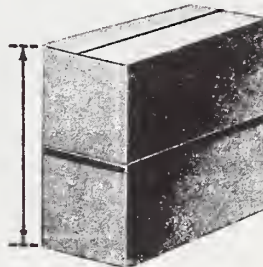

18 to 30

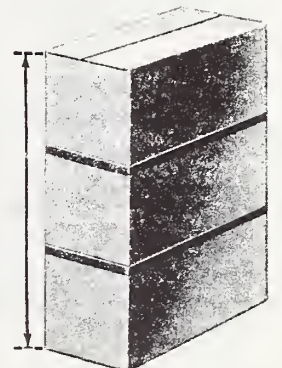

OVER 30 to 48

OVER 48—STRAP AS SPECIFIED

NOTE: ALL MEASUREMENTS SHOWN ARE IN INCHES.

See page 63 for parcel post size and weight limitations.

Figure 63. Relationships between box dimensions and number of straps.

(b) Plastic Straps

Plastic straps are usually made from nylon, polypropylene or rayon. These bandings are resilient under normal temperatures. High temperatures during summer, however, may cause expansion and loosening.

Plastic strapping is available in a variety of widths, thicknesses and tensile strengths. Several characteristics should be considered when selecting a particular material or size:

- Plastic straps tend to become loose on the parcel if kept under tension for extended periods of time or if the package settles or shrinks.
- Plastic strappings are not likely to cut into container edges but, if the package has hard, sharp edges, plastic straps may be sheared in mail processing.
- Plastic strapping, properly applied, is not considered to be hazardous to personnel, equipment, or other packages, and can be easily removed and disposed of at its final destination.

The straps must be positioned so that they will not interfere with address information or postage.

C.6 CLOSING COMPOSITE TUBES AND CANS

Composite fiber tubes and cans can be closed with screw tops, cuffs, slipcovers and telescoping end pieces.

On a screw top, as the name implies, threads on the cap match those on the body of the container. Cuffs are extensions of softer material on the ends of mailing tubes that are tucked tightly inside after contents such as calendars are inserted. (See Figure 64.)

Slipcover ends of either metal or plastic may be used to close one or both ends of a tube. With the telescoping tube, the bottom half is fitted with a smaller internal sleeve which protrudes some distance above the edge of the external container. In closing it for mailing, the top half of the tube is pushed down over the sleeve and the seam between the two outside sections is sealed with tape at least one inch wide. Either pressure-sensitive or gummed tape is appropriate for sealing but if water resistance is needed pressure-sensitive plastic tape should be employed.



Figure 64. Mailing tubes with cuff closures.

(NBS)

C.7 SECONDARY CLOSURE FOR GLASS CONTAINERS

Shock and vibration occasionally make the caps of glass containers work loose in transit. If a polyethylene or vinyl tape is stretched around the seam between container and cap, it will both hold the cap firmly in place, and discourage pilfering. (Shown in Figure 65.) Numerous patented methods are available for the secondary closure or sealing of such containers, including heat shrink plastics.



(NBS)

Figure 65. Use of tape as a secondary closure for glass containers.

D. ADDRESS CHARACTERISTICS

D.1 READABILITY

Postal employees who sort parcels attempt to read addresses and sort parcels at rates of up to 40 parcels per minute at a distance of 24" to 30". High speed sorting requires legible and visible address labeling by the mailer. Addresses should always be placed prominently on an unobscured part of the parcel. Special markings or advertisements should be as far away from the address as possible--ideally on a different face of the parcel. Readability or legibility depends primarily on size of print, spacing, and contrast.

(a) Size of Print

Normally, 60 to 90% of the parcels found in the mailstream are machine addressed (labels that are typed or printed). Size of print is a combination of letter height and letter width. For machine printed addresses, letter height should be between .10 - .20 inches, or 10 to 14 "point" type sizes. Regular newspaper type is 8 "point". Calculation of the appropriate letter width can be made using a letter width-to-height ratio of 3:5. The stroke width: letter height ratio should be from 1:6 to 1:8, where stroke width refers to the width of the ink print itself.

(b) Spacing

Extreme spacing, either between lines or between letters, numbers and words leads to slower reading. Use no extra spacing between the letters in a word or between the numbers in a group; put one space between words or sets of numbers and single spacing between lines. The result will be a compact block of reading material, one which will make for easy scanning and rapid identification.

(c) Contrast

The best contrast between printing and background, whether on a label, tag, or wrap, is provided by having black print on any of a range of tints of white ground. These color combinations maximize the brightness contrast needed for fast recognition.

(d) Other General Considerations in Readability

Although the use of all capitals in machine printing can increase word visibility, the speed with which the words can be read is reduced. Capitals (uppercase letters) should generally be used only for the first letter of proper nouns or names, with lower-case for those remaining.

Handwritten and hand-printed address labels present additional problems from a readability standpoint. When words are hand-printed, certain parts of certain letters should be emphasized. For instance "B" and "D" will be more legible if a little overhang (serif) is put at the top and bottom of the curved line. A well marked cross piece will aid in distinguishing "G" from "C". "Q" should have a definite strong oblique stroke on the "Tail" so it will not be confused with "O" and "C". Some of the more common misreadings resulting from typical hand printing involve: "f" and "t", "l" and "t", and "o" and "e". The numbers 9, 5, 2 should be carefully printed because they are often confused with 7, 8, and 3, respectively.

While the "finish" of the labeling paper has little significant effect on the speed of reading, high-gloss paper finishes should be avoided when possible because testing has shown these finishes to be more susceptible to damage than matte finishes. At certain angles, depending on illumination conditions, these finishes can reflect light into the eyes of the reader and reduce visibility. Thin semi-transparent stock paper should also be avoided.

Extraneous information including other labels, markings, and stampings, which concern handling or insurance, or are advertising messages hinder quick reading of addresses by leading the eye astray. Such information should be placed at least three (3) inches from the address block.

Indelible (preferably oil-based) ink is best for most types of labels and container materials as it resists abrasion, erasure and washing. Use of unclear, unprotected multi-copy carbon addresses is strongly discouraged because they always smear to some extent even under normal conditions; the printed characters are never "clean cut"; and they run if wetted. Furthermore, the paper on which these addresses often appear is usually low in tear resistance and not very durable.

Finally, the return address of the sender should be prominently located either on the address label itself (as far as possible from the address of the receiver) and must be on the same side of the package, ideally in the upper left-hand corner. Most critically, the mailer should be sure to include both ZIP CODES! Consult your local postmaster for other information or regulations concerning the addressing of packages for Parcel Post, including the special mail classifications discussed in Chapter 3.

D.2 ATTACHING THE ADDRESS LABEL

Properly attaching an address label to a package, involves: the properties of the label itself; the adhesive on the back of the label; labeling equipment; the surface of the parcel where the label will be placed; protection for the label and its surface; and compatibility between these factors to form what is often called a "labeling system". Successful applications depends to a large extent on an understanding of these factors. Figures 66 and 67 show the results of poor label application.



(NBS)

Figure 66. Inadequately applied address label.

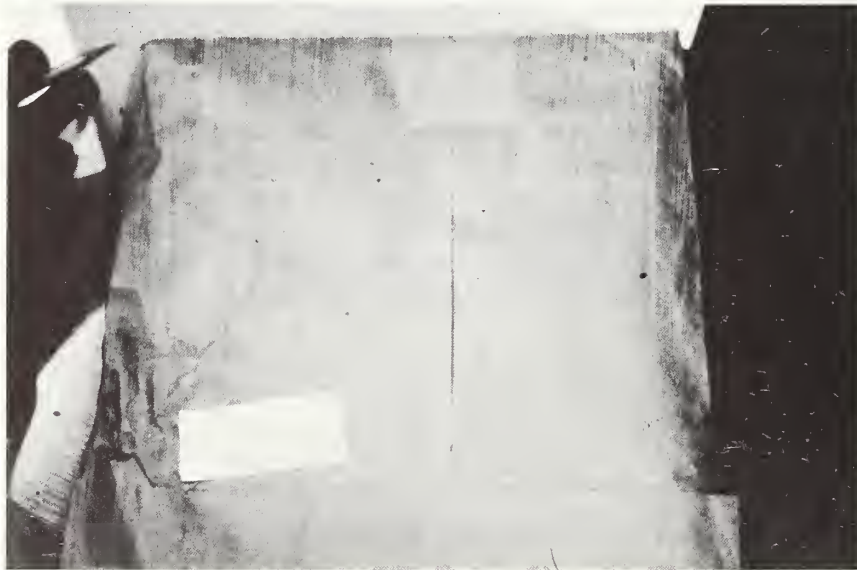

(NBS)

Figure 67. Parcel from which an inadequately applied address label has been lost.

(a) The Label Itself

Like most other packaging materials, labels are readily available in a wide variety of sizes, styles, imprints, surfaces for different kinds of writing or printing, and paper qualities. Some are gummed or pressure sensitive; others are plain and ungummed. Sometimes the physical shape of a package makes a tag the only practical means of labeling (some sacks and bundles or an irregular shaped package would make hunting for a label time-consuming).

Most labels are flat before application, but some tend to curl because of paper characteristics or adhesives which have a "pulling" effect on the paper, especially after aging. This doesn't mean that "curled" labels won't stick, but it does mean that greater care and observation of good application procedures is necessary. In addition, label surfaces should be checked to assure that the ink to be used in addressing is appropriate for the surface characteristics. Smearing or complete obliteration of the address may result if the ink or other marking is inappropriate for that particular surface. A check of the markings with a simple "once-over-lightly" rub test with both a dry and wet finger should reveal any incompatibilities.

(b) The Adhesive

Modern chemistry has produced a wide variety of materials for securing labels to surfaces. Good adhesion often depends not only on the label material itself but also on the manner with which it is applied. Among the most widely used products for this purpose are glues, liquid-activated and pressure-sensitive adhesives and thermally (heat) activated plastics.

- Ready Prepared Adhesives are excellent when fully and evenly spread on either the labels or receiving surfaces especially if the outer edges are well covered. Labels should then be pressed from the center outward to remove extra glue and assure full label contact. Not all glues offer sufficient "shear resistance" to withstand the continuing effects of postal handling so that glues and other adhesives should be selected which have been developed and recommended by the manufacturer for specific mailing application.
- Liquid-Activated Adhesives. These are used very commonly because of their simplicity and ease of application. They are found on the backs of gummed labels and tape and are usually activated with water although other liquids are sometimes recommended by the manufacturer. As in the case of glues, it is most important to assure that the adhesive is fully activated, especially at the edges; that labels are pressed firmly to the surface to assure that air and excess liquid are expelled; and that full contact is made with the surface of the parcel.

- Pressure-sensitive Adhesives. These are widely used on the backs of labels and often resemble the gummed label backing in appearance. In most cases, it is necessary to peel off a glossy backing sheet from the adhesive side or to remove one label at a time from a single sheet containing several. Once the "peelable" material is removed, the exposed adhesive is "pressure-sensitive". As the term implies, simply pressing the label onto a clean, non-greasy surface and elimination of the air beneath is all that is necessary. Laboratory tests have indicated that labels with pressure-sensitive adhesives have a tendency for corners and/or edges to "peel-back" if the adhesive is damaged by finger pressure or contaminations during application.
- Thermal (heat) Activated Plastics. These are used for label adherence as well as for "shrink wraps". When heat at a prescribed temperature is applied, the plastic material on the back of the label becomes sticky and serves as the adhesive between the label and the parcel surface. Both initial and continuing adherence are highly dependent on correct temperature, dwell-time and the pressure used in application.

(c) Tags

Shipping tags are often used for mailing items that are too large or too heavy to be properly packaged in a container. Such parcels have been previously described as "outsides" because they are not placed in a mail sack with other parcels. When the nature of the item to be mailed is such that it is accepted by the local post office and requires a shipping tag for proper identification of the mailer and the addressee, several simple rules should be followed:

- (1) Select a tag made from a durable material and with a reinforced hole.
- (2) Mark the tag with permanent ink or large type easily readable at a 30" distance. Do not use a lead pencil.
- (3) Secure the tag to the parcel with heavy-weight cord or wire. When using wire, twist the wire in a manner such that no open hoops are present and the ends do not create a hazard for postal employees, the address, or other parcels.
- (4) Do not use yarn, cloth, light-weight strings or rubber bands to secure the tag to the parcel.



(NBS)

Figure 68. Tag inadequately secured with yarn.

(d) Labeling Equipment

To provide for easy, economical and dependable labeling, a wide variety of labeling machines and devices are readily available. Perhaps the most common type of labeling machine is one which provides water to activate gummed labels. In using this kind of machine the water (or other liquid), rollers, and brushes should be kept clean at all times. When the device gets clogged there is danger of contamination, poor activation of the adhesive, or inadequate spreading of the liquid for complete coverage--three factors which contribute heavily to labeling failures. For situations where labels are used infrequently, a wide variety of small, inexpensive devices such as sprayers and urethane-tipped (sponge) moisteners are easily obtainable.

Machines with heating elements, temperature controls and speed regulators are needed to prepare thermoplastic labels for application. "Do-it-yourself" devices such as electric irons are not usually effective, even though initial tack and adhesion may be partially achieved.

(e) The Surface of the Package

The nature and condition of the package surface are critical factors in applying labels. Above all else, the surface must be free of dust, dirt and other contaminating substances. If the surface is not clean, poor adhesion will result and the label may come off.

Differences in the nature of parcel surfaces are almost limitless. Not only are there differences in the materials from which containers are made, but the surfaces of the various containers are often coated, painted or treated in some way. Some are glossy and smooth; others are dull and rough, with many variations between these extremes. Those which are absorbent tend to combine the adhesive with their own structure to create a good bond; those which are non-absorbent tend to bond on or near the surface and often reject the adhesive unless it is specifically designed to adhere to the particular surface material.

(f) Protection of the Label and the Label Surface

Under normal circumstances, the applied label requires no further protection. If there is evidence of lifting at the edges or corners, however, additional taping at each corner with small pieces of transparent label protection tape provides an important measure of added security. If inks other than "permanent" or "waterproof" are used for addressing, protection against smearing, smudging and rub-off can be obtained by using transparent, label protection tapes. Such tapes must be capable of retaining handwritten addresses made with commonly used writing instruments such as hand stamp, ball point pen and number 2 grade pencil. By extending the tape about one-half inch beyond the edges of the label, additional protection from lift-off is obtained.

Transparent plastic label protection tape with a pressure sensitive adhesive is also available. This label tape can be placed over the entire label for protection and is available in roll form. Use of this tape in roll form is shown in Figure 69.

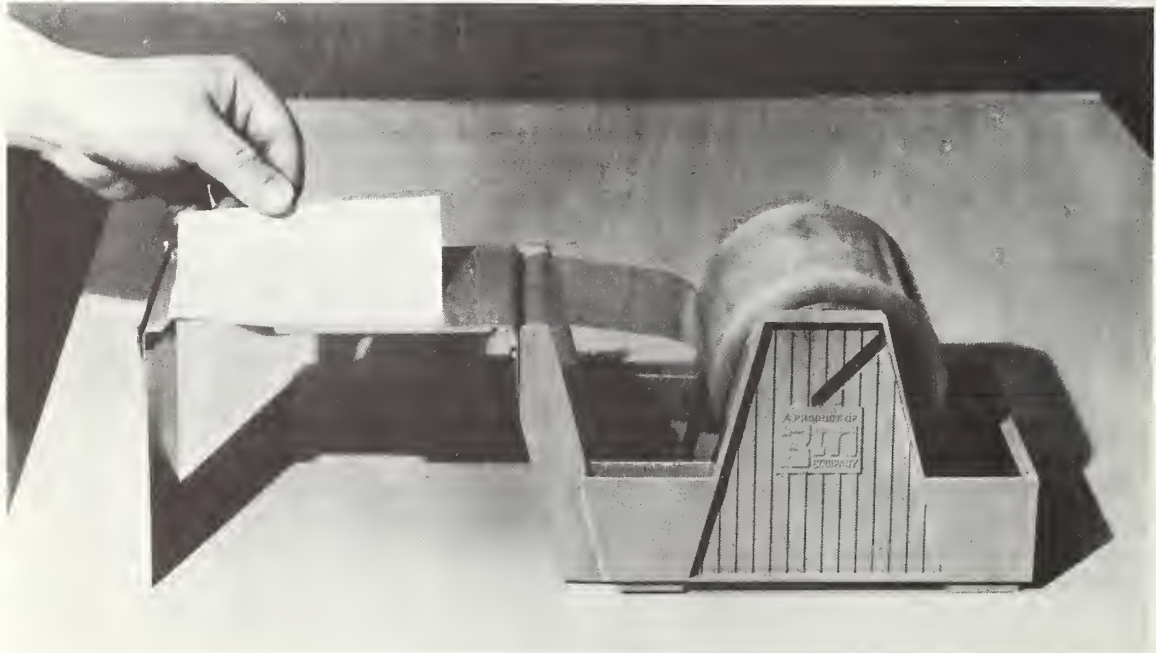

(Courtesy, 3 M Co.)

Figure 69. Use of transparent label tape.

(g) Compatibility

From what has been said above, it can be seen that "compatibility" is the real key to good label application or a successful labeling-addressing system. It's simply a matter of picking the right materials and using techniques that will cause all of the materials to work together. If the adhesive is right, the label will neither curl nor lift-off after application. If the surface is right, it will capture rather than reject the adhesive. If appropriate equipment is used, the label adhesive will be activated to do its proper job, and, if the overcoating or protection for the label is right, the ink--whatever its composition--will not run and smear.

Like the weakest link in a chain, one incompatibility in the application process can cause a label to lift-off with resultant loss of parcel identity. Occasionally some alert postal employee picks up the detached label and pastes it back on the right package but that is not something the mailer himself can control!

(h) Other Markings on Packages

Markings either identify the nature of the contents or specify the handling procedure desired by the mailer. Markings do not usually refer to the address label. Special markings should be used only when necessary, and only in compliance with Postal Service Guidelines on wording and positioning on the parcel.

Reused containers are acceptable to the Postal Service if previous markings have been removed or crossed out.

Place special markings on the Parcel:

1. Away from the address label area;
2. Away from the corners and edges of the parcel;
3. In large enough print to be read at two feet;
4. With special ink or protector tape cover to prevent streaking, smearing or abrasion from other parcels.

(i) The Inside Address

As a final bit of delivery insurance, put a card inside the parcel, containing the same address information for sender and receiver as on the outside. Should the wrapper be torn or the forwarding address be rendered illegible, the inside address can be used to forward the goods to their destination.

E. AVAILABILITY OF PACKAGING COMPONENTS

In general, the availability of packaging materials is somewhat more limited for the average person than for a medium to large business firm which mails many packages daily. Such firms usually have specialized packaging departments or, at the very least, a packaging section in a shipping department. Their packaging materials are generally bought in volume. Large volume parcel mailers should be aware of the many packaging industry trade associations or professional organizations which are able to help in locating packaging materials and can give expert advice on particular packaging problems. These associations include, but are not limited to:

Fibre Box Association
224 South Michigan Ave.
Chicago, Illinois 60604
(Other offices in New York, San Francisco, and Lakeland, Florida)

Packaging Institute, U.S.A.
342 Madison Ave.
New York, New York 10017

Gummed Industries Association
380 N. Broadwood
Jericho, New York 11753

Technical Association of the Pulp and Paper Industry
One Dunwoody Park
Atlanta, Georgia 30341

Pressure Sensitive Tape Council
1201 Waukegan Rd.
Glenview, Illinois 60025

Society of Packaging and Handling Engineers
14 East Jackson Blvd.
Chicago, Illinois 60604

Additional listings and information can be obtained from the "Modern Packaging Encyclopedia and Planning Guide" (Dec. 1973), published by McGraw-Hill, Inc.

Interested mailers can also keep up with the rapidly advancing state-of-the-art in packaging by subscribing to or obtaining copies of such trade journals as "Modern Packaging" and "Packaging Engineering." These magazines often contain advertisements which give information about where to buy packaging materials.

The occasional user of Parcel Post is generally more limited than the large mailer in choosing packaging materials. Places which sell packaging materials to the public (such as department stores, drug stores, specialty shops, and novelty shops) do not usually have the variety of materials or the specialized materials found in wholesale packaging companies which only sell in volume. Some boxes, internal packaging material, tapes, and other closures are available at some retail stores. Corrugated containers can often be obtained from supermarkets and other stores, but the mailer must package them carefully if they are going to be reused for mailing. For special packaging materials, the mailer can look in the classified section of the telephone directory under "Packaging Materials" and "Packaging Services".

The Postal Service sells some boxes, cushioning bags, tape, and internal packaging materials at many post offices. Some post offices will package goods for the mailer for a small fee.

The availability of packaging materials can vary from area to area and from time-to-time due to seasonal changes. Energy and pollution problems, in terms of waste disposal and recycling, will continue to have a significant impact on the availability of packaging components. Inflationary trends also have an effect on availability and cost.

For the reasons cited above, users of Parcel Post will have to compare packaging costs with the desired result--parcels which are delivered in good condition. These comparisons are often very difficult. Too much packaging may mean extra cost, effort, and time. Too little packaging results in parcel damage and loss of money, effort, and time. Proper packaging should produce an adequate package for the least cost and effort.

For those interested mailers Appendix C provides a listing of U.S. Government publications related to description, selection and use of packaging components discussed in this chapter. Section XV of Appendix C cites several test specifications and procedures adopted by the American Society for Testing and Materials (ASTM).

APPENDIX A

TEMPERATURE TABLE

The temperatures shown in the following pages represent the normal high and the normal low values for each of the twelve months. The values listed are not the highest and lowest temperatures on record, but represent the average of the high and low values, respectively, over a period of the past twenty to forty years. Appropriate adjustments have been made to remove the abnormalities introduced by unusually high and low temperatures on record.

TEMPERATURES

STATE & CITY	JAN.		FEB.		MAR.		APR.		MAY	
	Normal		Normal		Normal		Normal		Normal	
	High	Low	High	Low	High	Low	High	Low	High	Low
Alabama										
Montgomery	59.0	38.0	61.0	40.0	67.0	45.0	76.0	52.0	80.0	57.0
Alaska										
Juneau	30.1	20.0	32.1	21.4	36.5	24.3	45.4	30.5	53.6	37.6
Fairbanks	- .8	-21.4	9.5	-15.3	23.5	-5.7	42.1	16.6	59.1	35.1
Barrow	-9.4	-23.0	-12.2	-24.4	-8.1	-21.1	7.4	-7.0	23.5	13.3
Arizona										
Yuma	69.3	43.5	73.9	46.2	80.8	51.1	88.3	57.5	95.8	64.3
Flagstaff	41.4	15.1	43.6	17.5	49.5	21.6	58.6	28.0	67.8	34.0
Tucson	62.6	36.0	66.0	38.8	72.2	42.8	81.1	49.6	89.4	56.5
Arkansas										
Little Rock	50.6	30.5	54.6	34.1	62.7	40.9	73.5	51.2	81.5	59.5
California										
San Diego	64.6	46.4	65.4	47.9	66.7	50.2	68.2	53.8	69.9	57.0
Bishop	52.7	20.8	56.1	25.3	63.8	30.3	72.5	37.7	80.9	44.2
Eureka	53.6	41.1	54.2	42.1	54.5	42.8	55.7	45.1	57.9	48.1
Sacramento	53.4	40.3	58.7	43.2	64.6	45.8	71.3	49.3	77.9	53.4
Colorado										
Alamosa	35.6	-.8	41.0	5.9	49.0	15.2	58.9	24.7	68.1	33.4
Denver	43.1	16.8	45.6	19.3	50.9	24.8	60.5	34.3	69.5	43.8
Connecticut										
Hartford	35.6	17.6	37.0	18.5	44.9	26.4	58.7	36.7	70.8	46.8
Delaware										
Wilmington	41.3	25.5	42.4	25.2	50.5	32.0	62.5	41.6	73.4	52.0
Florida										
Miami	75.8	57.9	77.0	58.8	79.8	61.1	82.6	65.8	85.4	69.7
Daytona Beach	69.6	40.7	70.9	50.2	74.2	53.4	78.8	59.0	83.5	64.9
Tallahassee	65.1	42.7	67.0	44.2	72.2	49.0	79.0	55.9	86.4	63.3
Georgia										
Atlanta	54.0	35.5	56.5	36.5	62.9	40.9	72.1	49.9	80.5	58.6
Savannah	62.5	40.9	64.4	41.7	69.6	46.9	77.3	54.1	84.8	62.0
Hawaii										
Honolulu	79.1	65.8	78.8	66.0	79.2	66.4	80.2	68.1	81.8	70.0
Idaho										
Idaho Falls	26.5	.2	32.2	5.6	42.4	16.1	58.2	27.9	68.7	36.6
Lewiston	37.7	23.7	44.1	27.7	52.5	32.7	62.7	38.8	71.3	45.5
Illinois										
Chicago	33.2	18.9	35.3	20.4	44.0	28.6	58.6	39.6	70.5	49.7
Springfield	36.3	20.5	39.6	22.5	49.1	30.3	62.8	41.9	73.6	52.2
Indiana										
Evansville	42.7	25.6	45.7	27.4	54.3	34.2	66.6	44.8	76.4	54.1
South Bend	33.0	18.1	34.5	19.0	43.4	26.3	57.9	37.0	69.8	47.5
Iowa										
Burlington	32.7	16.1	36.5	19.1	46.9	27.6	61.4	40.2	72.5	51.1
Sioux City	28.9	8.5	32.7	12.6	43.5	23.7	60.9	36.8	72.9	48.8
Kansas										
Dodge City	42.4	19.7	46.6	23.3	54.3	29.3	66.1	41.1	75.5	51.9
Goodland	40.9	13.9	44.5	17.2	50.3	22.7	62.3	33.9	72.1	44.8
Kentucky										
Lexington	42.9	26.1	45.0	26.5	53.2	33.2	65.1	43.6	75.5	53.4
Louisiana										
New Orleans	64.4	43.8	66.7	45.5	71.2	49.6	77.7	56.1	84.4	63.4
Shreveport	56.7	38.3	59.7	40.9	66.5	46.6	75.4	55.2	83.1	63.1

TEMPERATURES

JUNE		JULY		AUG.		SEPT.		OCT.		NOV.		DEC.	
Normal High	Normal Low	Normal High	Normal Low	Normal High	Normal Low	Normal High	Normal Low	Normal High	Normal Low	Normal High	Normal Low	Normal High	Normal Low
90.0	69.0	92.0	72.0	92.0	71.0	88.0	66.0	79.0	55.0	66.0	42.0	59.0	38.0
60.8	43.7	62.7	47.8	61.5	46.6	55.2	42.5	46.5	36.7	39.2	29.4	32.7	24.0
71.1	45.6	71.7	47.5	65.3	43.2	53.9	33.3	35.4	17.0	13.4	-5.6	2.1	-17.5
37.5	28.7	44.9	33.3	42.7	33.1	33.8	27.2	21.4	11.8	5.3	-6.7	-5.0	-17.4
103.4	72.0	108.2	81.3	106.5	80.4	103.4	74.8	92.0	62.6	78.7	50.0	70.8	45.1
77.3	41.6	81.4	50.6	78.9	49.8	74.6	42.3	63.2	31.7	51.4	21.7	43.9	17.9
98.2	66.1	99.0	73.1	95.7	71.5	94.3	67.4	84.2	55.8	71.9	43.2	64.9	37.9
89.7	68.0	92.7	71.1	92.4	70.1	86.3	62.2	76.0	50.2	61.3	37.6	52.1	31.7
71.6	59.8	75.8	63.4	76.9	64.5	76.6	62.2	73.4	57.8	71.1	51.4	67.0	48.2
89.7	49.9	97.0	55.2	95.3	52.2	88.8	46.5	76.5	37.3	64.0	27.5	55.1	23.4
60.1	50.9	60.5	52.0	60.9	52.5	61.6	51.1	60.3	48.5	57.5	44.9	55.1	42.7
85.5	57.5	92.0	60.0	90.6	58.9	87.7	58.0	76.5	52.8	64.2	45.2	54.3	41.2
78.6	41.4	82.5	47.2	80.3	45.7	75.2	36.1	64.2	24.6	48.9	10.0	37.9	.4
81.0	53.0	87.4	59.4	85.8	58.2	78.0	49.0	66.6	38.2	52.7	25.6	46.2	20.0
79.1	56.0	83.4	60.9	81.0	59.3	73.2	51.3	63.8	40.7	50.7	31.7	38.4	20.5
81.8	61.0	86.2	65.8	84.2	64.3	77.9	57.3	67.3	45.9	55.1	35.7	43.5	26.7
88.0	73.5	88.8	74.7	89.7	74.9	88.0	74.6	84.7	70.9	80.2	64.6	77.1	59.1
86.9	69.9	88.2	72.0	88.3	73.1	86.2	72.2	81.2	65.6	74.4	56.1	70.1	50.4
90.5	69.9	90.5	72.0	90.3	71.8	87.2	68.9	80.6	58.6	71.1	47.3	55.4	42.8
87.3	66.3	88.4	69.2	88.3	68.4	83.1	63.1	73.6	51.7	62.0	40.1	53.3	34.8
90.2	69.1	91.2	71.4	90.8	71.2	85.9	67.4	78.1	56.3	69.1	45.5	62.6	40.2
83.8	72.0	84.6	73.0	84.9	73.8	85.2	73.2	84.2	72.1	82.0	69.7	79.2	67.9
76.9	42.7	89.0	49.2	84.4	46.3	75.5	36.7	61.6	26.6	41.9	14.2	31.3	6.3
77.8	51.8	89.8	57.8	87.8	55.5	78.3	48.7	63.6	40.3	47.6	31.9	41.5	28.3
81.0	60.4	85.6	65.7	84.2	64.6	76.6	56.2	65.0	45.7	47.9	32.1	36.0	22.3
83.4	62.5	87.6	66.4	85.8	64.5	79.3	55.9	68.1	45.3	50.6	32.0	39.2	23.8
86.0	63.6	89.3	67.2	88.0	65.6	81.9	57.2	71.2	46.0	55.1	34.4	44.6	27.5
79.9	58.0	84.5	62.6	82.9	61.1	74.3	53.2	63.8	42.9	47.0	31.2	35.7	21.7
82.7	61.5	87.6	65.6	85.2	63.9	77.3	54.6	66.6	44.1	48.8	29.9	36.5	20.3
82.5	59.3	88.5	64.2	85.9	62.2	77.2	51.8	65.9	40.1	46.7	24.5	34.5	14.4
86.8	61.9	92.8	67.5	91.7	66.6	82.9	57.6	71.1	45.5	55.1	30.4	45.8	23.6
84.3	55.0	91.8	61.3	89.7	59.7	81.2	49.7	68.6	37.5	52.1	23.9	43.5	17.3
84.5	62.6	88.2	66.5	86.7	65.2	80.8	57.8	69.2	46.9	54.0	35.3	44.1	27.6
89.6	69.5	90.6	71.6	90.7	72.0	87.2	68.3	80.3	59.5	70.3	48.6	65.3	44.5
90.6	70.5	93.2	73.2	93.8	72.7	88.5	67.0	79.2	55.3	65.8	44.5	59.1	40.0

TEMPERATURES

STATE & CITY	JAN.		FEB.		MAR.		APR.		MAY	
	Normal		Normal		Normal		Normal		Normal	
	High	Low	High	Low	High	Low	High	Low	High	Low
Maine										
Caribou	19.8	1.1	22.3	2.6	31.8	13.8	45.0	27.7	60.7	39.1
Portland	31.8	11.7	33.5	12.1	40.7	22.0	52.5	32.4	64.2	41.7
Maryland										
Baltimore	44.2	25.3	45.5	25.8	53.6	32.5	65.8	42.6	75.9	52.8
Massachusetts										
Boston	36.8	23.0	37.4	23.1	44.6	30.7	55.7	40.0	67.5	50.1
Michigan										
Alpena	28.9	12.4	29.8	10.3	37.1	17.3	51.9	29.3	65.5	38.7
Detroit	32.9	19.1	34.0	19.2	42.6	26.1	56.7	36.6	68.7	47.1
Grand Rapids	31.5	17.3	32.4	16.6	40.9	23.9	56.2	35.2	68.3	45.7
Marquette	25.7	13.2	26.6	12.8	33.4	20.0	46.6	31.9	58.8	40.9
Minnesota										
International Falls	14.2	-8.1	19.2	-5.0	30.9	7.9	48.5	26.3	63.3	38.1
Minneapolis	22.4	2.5	26.3	5.4	37.4	17.8	56.0	33.3	69.6	45.6
Mississippi										
Jackson	58.3	37.6	61.5	39.9	67.9	44.8	75.8	52.9	83.8	61.2
Missouri										
St. Joseph	37.2	17.1	41.4	20.7	51.0	29.7	64.9	42.3	75.1	53.0
Springfield	43.4	23.8	47.4	26.7	54.7	33.3	66.4	44.8	74.9	54.0
St. Louis	40.2	23.5	44.0	26.3	52.8	33.4	65.9	44.8	76.1	55.3
Montana										
Billings	33.2	13.1	36.0	15.3	43.4	23.0	57.4	33.6	68.1	43.4
Glasgow	19.6	-0.1	24.1	3.0	37.1	16.2	55.9	30.8	68.1	42.1
Nebraska										
Omaha	29.2	11.4	33.3	15.3	44.0	25.3	60.2	38.8	71.5	49.8
Valentine	33.3	6.7	36.2	9.7	43.7	18.9	59.1	32.3	70.8	43.3
Nevada										
Elko	35.1	10.0	40.4	15.6	48.6	22.2	60.1	28.5	69.2	34.8
Las Vegas	55.2	32.0	60.4	36.1	68.6	42.0	78.6	51.4	87.9	59.6
Reno	46.6	17.2	50.8	21.4	57.3	24.6	65.4	29.5	72.5	34.3
New Hampshire										
Concord	31.7	10.6	33.5	11.8	41.7	21.7	55.9	31.7	69.3	41.6
Mt. Washington Observatory	14.7	-2.2	13.9	-2.8	19.0	4.4	29.6	16.3	41.3	28.7
New Jersey										
Trenton	40.0	26.2	40.9	25.9	48.8	32.5	61.3	42.0	72.3	52.3
New Mexico										
Albuquerque	46.4	23.5	52.2	27.5	59.8	32.7	70.1	41.2	79.3	50.9
Roswell	54.1	18.6	59.4	21.7	67.8	28.1	76.9	38.0	84.7	48.2
New York										
Albany	31.0	14.4	32.5	14.8	41.9	24.0	56.7	35.7	69.5	46.3
Buffalo	29.8	17.2	30.0	16.2	37.6	23.4	51.9	34.0	64.5	44.1
New York	39.6	27.5	40.4	26.8	47.8	33.8	59.3	43.0	70.7	53.4
La Guardia										
North Carolina										
Asheville	49.0	30.4	50.7	30.5	56.9	35.5	67.6	44.4	76.2	52.5
Wilmington	58.4	37.3	59.4	37.9	65.1	43.2	73.6	51.4	81.0	60.0

TEMPERATURES

JUNE		JULY		AUG.		SEPT.		OCT.		NOV.		DEC.	
Normal High	Normal Low	Normal High	Normal Low	Normal High	Normal Low	Normal High	Normal Low	Normal High	Normal Low	Normal High	Normal Low	Normal High	Normal Low
69.3	48.6	75.1	53.9	73.4	51.8	64.1	43.5	52.0	34.0	36.8	23.5	23.5	7.5
73.1	51.1	79.5	56.7	78.4	55.2	70.2	47.2	59.8	37.4	47.6	28.6	35.3	16.3
83.5	61.4	87.2	66.4	85.0	65.0	78.6	57.6	68.4	45.6	56.5	34.4	45.7	25.9
76.3	59.2	81.9	65.4	80.0	63.3	73.4	57.1	62.7	47.2	51.9	37.8	40.1	26.5
75.6	48.6	80.4	53.4	78.5	52.5	69.4	45.6	58.9	36.6	43.5	27.7	31.9	17.3
78.9	57.8	83.7	62.1	81.8	61.0	74.1	53.5	62.8	43.1	46.9	31.8	35.5	22.2
78.6	56.2	83.6	60.1	82.1	58.9	73.4	50.9	61.9	40.4	45.8	30.5	34.5	21.4
69.6	50.6	75.7	57.6	74.0	57.5	65.7	49.7	55.4	40.6	39.3	28.2	29.3	18.9
72.2	47.5	78.4	52.8	75.2	51.0	64.4	41.3	52.9	31.8	31.4	16.2	19.0	-0.2
78.7	55.9	84.7	61.2	81.8	59.1	72.1	48.8	59.8	36.7	39.7	21.3	27.0	8.5
90.3	68.4	91.9	71.2	92.0	70.5	87.7	64.7	79.1	53.9	67.1	42.7	59.7	38.3
85.0	63.0	91.0	67.8	89.0	66.0	81.0	56.2	70.1	44.7	52.2	30.5	41.2	21.7
84.9	63.5	90.3	67.2	90.0	66.0	83.1	57.7	72.2	47.1	56.3	33.7	46.4	27.0
86.1	65.1	90.2	68.9	88.3	67.3	81.3	58.6	70.1	45.6	53.7	34.5	43.0	26.5
76.0	51.1	88.5	57.8	86.2	55.6	74.5	46.3	62.6	37.3	46.0	26.2	38.6	19.2
74.4	50.1	85.3	56.1	82.7	52.9	70.7	42.6	58.2	32.5	38.0	18.3	26.9	8.4
81.0	60.5	87.0	65.1	84.4	63.4	76.5	53.7	65.7	42.0	46.7	27.0	34.7	17.4
81.2	53.8	90.6	60.2	87.8	57.9	77.7	45.8	65.5	33.1	47.9	19.3	38.3	11.9
78.8	41.1	90.8	48.3	88.8	44.9	79.5	36.2	65.8	28.0	49.3	19.0	39.1	13.7
98.2	68.5	104.5	75.8	102.0	73.4	95.3	65.6	81.1	53.1	66.0	39.9	57.2	32.9
81.3	38.8	91.4	44.9	90.3	42.7	83.2	37.4	41.0	29.4	57.7	20.8	49.3	17.4
77.7	51.3	82.8	56.4	80.6	54.1	72.4	46.2	61.7	35.6	47.9	27.2	35.1	14.8
51.1	38.6	54.9	43.3	53.2	42.1	46.8	35.2	37.0	24.8	26.8	13.8	16.5	1.0
80.7	61.3	85.7	66.7	82.8	65.0	76.2	57.9	65.9	47.7	53.6	38.0	42.2	28.2
89.6	60.1	92.2	64.8	90.0	63.3	83.3	57.6	71.7	45.3	57.1	31.1	48.3	25.6
93.5	57.6	93.4	60.7	92.3	59.8	86.0	52.3	75.8	41.1	63.0	26.7	54.9	20.1
78.7	55.8	83.7	60.5	81.4	58.5	72.9	50.3	61.8	39.8	47.5	30.6	34.5	18.5
75.1	54.5	80.1	59.4	78.6	58.1	71.5	51.2	60.1	41.4	45.5	31.7	33.3	21.1
80.0	63.0	84.8	68.8	82.9	67.8	67.2	61.3	65.9	51.3	53.8	41.0	42.4	30.3
83.2	60.3	85.0	63.7	84.0	62.9	78.7	56.8	69.3	45.8	57.4	35.5	49.7	30.2
87.4	67.9	89.0	70.0	88.1	70.7	84.0	66.4	75.7	55.0	66.8	43.9	59.3	37.1

STATE & CITY		TEMPERATURES									
		JAN.		FEB.		MAR.		APR.		MAY	
		Normal High	Normal Low	Normal High	Normal Low	Normal High	Normal Low	Normal High	Normal Low	Normal High	Normal Low
North Dakota											
Bismarck		19.6	-1.9	23.3	1.7	35.1	15.3	54.9	31.1	68.2	42.6
Devils Lake		13.6	-4.4	17.9	-0.8	30.7	12.4	50.2	29.6	65.1	41.6
Ohio											
Cincinnati Abbe Observatory		41.3	26.1	43.4	26.7	52.0	33.3	64.4	43.9	74.9	53.5
Cleveland		34.8	20.3	35.6	20.6	44.1	26.7	57.5	35.7	68.7	46.3
Columbus		38.8	23.0	40.5	23.7	49.4	30.3	62.2	40.4	73.5	50.4
Oklahoma											
Oklahoma City		45.9	27.1	51.3	30.2	59.5	36.5	69.6	48.1	77.1	57.6
Oregon											
Burns		35.2	14.3	40.4	18.9	48.8	25.9	59.8	32.2	68.0	38.8
Portland		43.7	33.0	48.8	35.1	54.2	37.9	61.7	41.8	67.5	47.2
Pennsylvania											
Philadelphia		40.3	24.3	41.8	24.6	50.3	31.6	62.6	41.4	73.4	51.8
Pittsburgh		36.5	21.2	37.6	20.7	46.1	27.4	60.0	37.9	71.4	48.1
Scranton		32.6	20.7	34.1	20.4	42.7	27.7	56.4	38.4	68.4	48.7
Rhode Island											
Providence		37.3	21.0	38.3	21.1	45.3	28.6	56.6	37.7	67.7	47.2
South Carolina											
Charleston		61.2	39.3	62.5	40.4	68.0	45.4	75.9	52.7	82.9	60.8
Spartanburg		52.6	34.5	54.9	35.1	61.5	40.3	72.0	49.7	80.6	58.5
South Dakota											
Rapid City		34.1	9.8	35.9	12.3	42.5	19.7	56.7	32.3	67.8	43.6
Sioux Falls		25.1	5.2	29.1	9.0	39.4	20.8	57.0	34.7	70.1	46.5
Tennessee											
Nashville		48.8	30.9	51.4	32.5	59.4	38.7	70.8	48.4	79.8	57.4
Texas											
Amarillo		48.8	23.5	52.9	26.6	60.4	31.7	70.0	42.0	78.1	51.9
Brownsville		70.5	52.2	73.2	54.7	76.8	59.0	82.3	65.5	87.1	70.8
Ft. Worth		56.0	34.9	59.8	38.6	67.3	44.4	75.6	53.9	82.8	62.6
San Antonio		62.5	41.6	66.1	44.7	72.4	49.6	78.8	57.6	85.2	65.4
Utah											
Milford		37.1	12.1	47.2	17.2	52.4	24.5	63.6	31.8	73.3	39.6
Vermont											
Burlington		27.4	8.9	29.1	9.6	38.3	20.0	53.4	33.0	67.4	44.2
Virginia											
Norfolk		50.2	32.2	51.0	32.2	57.2	38.7	68.0	47.9	77.3	57.7
Washington		44.3	29.5	46.1	29.4	53.8	35.8	65.8	45.6	75.5	56.0
Washington											
Seattle Boeing		45.2	31.1	49.5	33.6	54.3	36.4	61.8	40.7	68.5	46.2
Stamper Pass		27.5	19.5	31.1	22.1	34.8	25.1	42.6	30.3	51.0	36.7
Yakima		36.5	18.5	44.7	23.2	55.3	28.7	65.8	35.2	74.1	42.8
West Virginia											
Huntington		46.8	28.3	48.6	28.5	56.5	34.4	69.2	44.1	78.6	53.0
Wisconsin											
Green Bay		25.1	7.5	26.9	8.3	36.0	19.4	52.4	32.9	65.3	43.2
Madison		27.9	8.1	30.2	9.8	40.0	19.2	56.0	32.8	68.4	43.8
Wyoming											
Cheyenne		38.2	13.6	40.4	15.2	44.1	19.7	54.5	28.6	64.1	38.6
Sheridan		34.0	8.6	36.4	11.1	42.9	19.1	56.3	30.6	66.8	40.4

TEMPERATURES

JUNE		JULY		AUG.		SEPT.		OCT.		NOV.		DEC.	
Normal High	Normal Low	Normal High	Normal Low	Normal High	Normal Low	Normal High	Normal Low	Normal High	Normal Low	Normal High	Normal Low	Normal High	Normal Low
76.5	52.4	85.7	58.7	83.7	55.8	72.6	44.7	59.4	33.0	38.6	18.1	26.9	6.6
73.7	51.3	82.0	57.4	79.7	54.7	68.5	44.2	55.2	33.3	33.7	16.8	20.9	3.7
83.8	63.0	87.5	66.3	86.4	64.9	80.3	57.6	68.9	46.8	53.2	36.0	42.6	27.9
78.1	56.2	81.8	60.2	80.2	58.5	73.5	51.3	62.6	41.0	48.0	30.8	36.9	21.9
82.9	59.6	86.6	62.9	85.0	61.4	78.6	54.2	66.8	43.5	51.6	32.8	40.6	24.4
86.4	66.5	91.8	70.2	92.5	70.0	84.7	61.9	73.9	50.8	58.8	37.0	49.2	30.4
75.0	44.6	86.8	52.1	84.7	49.6	76.6	40.9	64.2	32.5	48.3	23.9	39.1	19.0
71.8	52.2	78.6	55.7	77.9	55.2	73.7	50.7	63.2	45.1	51.7	38.4	46.5	36.1
81.6	60.4	85.9	65.2	83.7	63.5	77.2	56.2	66.5	44.9	54.0	34.5	42.3	25.5
79.9	56.9	83.3	60.9	81.9	59.6	75.5	52.8	63.7	42.4	49.5	32.0	38.1	23.2
76.4	47.9	80.6	62.2	77.8	60.2	70.4	52.5	59.7	42.3	46.2	32.9	34.8	22.9
76.1	56.3	81.4	62.7	80.0	60.9	73.1	53.3	63.4	42.9	52.2	33.8	40.4	23.5
88.2	68.1	89.2	71.0	88.8	70.5	84.9	66.2	77.2	55.1	67.9	43.9	61.3	38.6
88.2	66.9	89.2	69.2	87.9	68.2	82.4	62.7	73.1	51.6	61.6	40.6	52.7	34.3
77.0	52.8	87.7	59.9	86.0	58.0	75.6	47.6	63.1	36.8	47.0	23.2	38.7	15.7
79.4	56.8	86.0	62.5	83.3	60.3	73.5	50.0	61.9	38.6	42.5	22.7	30.3	11.9
88.4	66.3	90.7	69.6	89.9	68.4	84.5	61.1	73.7	49.3	59.1	37.9	50.3	32.4
89.0	61.9	92.2	66.0	91.0	65.0	83.4	57.2	72.7	46.2	59.1	31.8	51.2	26.3
90.7	74.7	92.5	75.5	92.8	75.3	89.8	72.6	85.1	66.6	77.0	58.2	72.2	53.5
91.6	71.3	95.9	74.9	96.2	74.6	89.3	67.5	79.4	56.4	66.1	43.5	58.2	37.2
91.6	72.2	94.0	73.9	94.2	73.4	88.5	68.7	81.5	59.6	70.4	48.5	65.4	42.0
83.9	46.9	92.1	55.5	90.1	54.3	81.3	44.9	67.1	34.2	51.3	20.9	41.4	15.0
77.1	54.2	81.9	59.0	79.6	56.8	70.6	49.1	58.6	38.6	44.4	29.1	31.2	14.8
84.9	66.3	87.9	69.6	86.2	68.8	80.9	64.3	70.9	53.1	61.0	41.8	51.8	33.1
83.4	64.9	87.0	69.3	85.0	67.9	78.6	60.7	68.3	49.6	56.5	38.9	45.6	30.5
73.1	51.2	78.4	54.9	77.1	54.0	71.5	49.4	62.3	42.9	52.4	35.9	47.3	33.5
56.7	41.0	65.4	47.0	64.5	46.7	59.8	44.0	48.1	36.6	35.7	27.1	30.9	23.0
80.0	48.8	88.9	53.1	86.5	50.6	78.8	43.8	65.6	35.4	48.1	26.7	39.7	23.3
85.9	61.9	88.4	66.0	87.6	64.6	82.3	57.5	71.3	46.0	57.5	35.8	47.7	29.5
75.4	53.5	81.0	58.0	79.0	56.8	70.3	48.6	58.6	38.1	41.2	26.1	29.1	13.8
78.0	54.2	83.2	59.0	81.2	57.7	72.6	49.4	62.1	38.7	44.3	24.6	31.8	13.4
75.5	47.5	84.2	53.8	81.8	52.6	73.2	43.0	61.7	33.2	47.2	22.2	41.6	16.4
75.4	45.6	87.1	55.5	85.6	53.4	74.1	43.4	62.3	33.2	46.1	20.6	38.5	14.0

APPENDIX B

INTERNAL PACKAGING FUNCTIONS AND SELECTION FACTORS

In order to choose proper internal packaging materials and use them correctly, the mailer must

- Know the characteristics of the external container (See Section A of Chapter 4);
- Know the characteristics of his product (discussed briefly below, and in detail in Chapter 3);
- Know the functions internal packaging can perform; and
- Know the characteristics of internal packaging materials themselves.

This Appendix discusses internal packaging functions, product characteristics, and internal packaging characteristics.

I. INTERNAL PACKAGING FUNCTIONS

- (a) Cushioning means protecting the contents of parcels by using internal packaging materials which absorb vibrations or the forces resulting from shocks. In cellular types of cushioning (shown in Figure B-1) the energy is damped or reduced as it compresses the air trapped in individual cells. With non-cellular materials; the energy is absorbed by the elastic and plastic properties of the material itself.

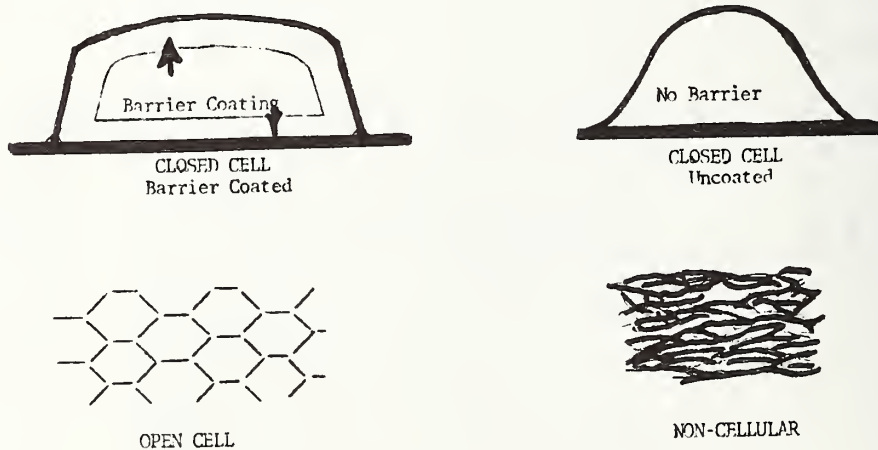

Figure B-1. Internal construction of cushioning materials.

(NBS)

When the mailer is choosing a cushioning material, he must first consider whether the material will evenly distribute the weight of the goods over the entire surface of the container. If improper cushioning is selected and the contents are very light in weight, shock may have the effect of bouncing the contents against the packing with no reduction in the force of the blow. Conversely, if the goods are too heavy, the contents may compress the cushioning to the point of bursting air cells, permanently flattening the cushioning medium, or penetrating to the container wall.

- (b) Separation. Separators, panels, or partitions made of corrugated fiberboard, molded pulp, foam slabs, vacuum-formed plastics, and other materials are used in packaging multiple items within a single container. The separation of the individual items provides protection from the undesirable effects of movement within the parcel. The parcel shown in Figure B-2 failed in the first stage of processing because there was no separation of the contents. Figure B-3 shows correctly designed separators, properly used.



Figure B-2. Canned food packaged without separators, hammered their way out of the parcel.

(NBS)

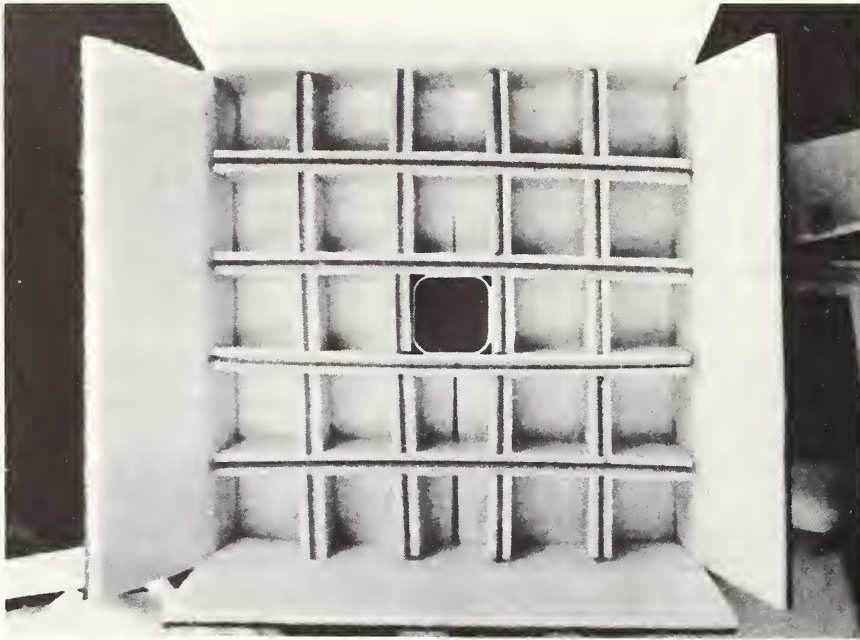

(Courtesy, Dow Chemical Co.)

Figure B-3. Internal separation using plastic materials.

- (c) Retention. Products should not be allowed to move about inside their container during the trip. The restraining of such movement by means of internal packaging materials is called retention.
- (d) Suspension. Some irregularly shaped or delicate items are difficult to cushion well enough for adequate protection. In such cases they may be suspended from one or more of the inner faces of a rigid or semi-rigid container by slings, cradles, or other means. The mailer must always consider the natural vibrating frequencies of the load in suspending the contents within the parcel. (Fragile items such as table lamps held in an envelope and suspended in a wire frame and placed diagonally in a corrugated box is a recommended method of shipment.)
- (e) Surface Protection. If the surface of a product is one aspect of its value (such as with furniture, art objects, jewelry, etc.), the surface should be protected from abrasion, staining or marring. A covering of noncorrosive paper or plastic will protect against contact with certain types of rough-textured cushioning materials, or internal bracing. For specialty items which require extra protection, kraft paper with a cohesive coating should be applied.

Surface protection devices are themselves subject to abrasive influences from cushioning materials, from the jostling of products in the same container, and from contact with container walls. Possible damage from these sources can be reduced by using cellulose wadding, kraft paper, tissue, newspaper, plastic foam, or fabrics.

- (f) Blocking and Bracing. Mechanical, rigid supports can be used between the goods and the container walls to prevent free movement. These supports, known as blocking or bracing, help to make irregularly shaped items fit into regularly shaped containers and keep projecting points from piercing the container walls. Braces should stand against the strongest parts of the external container and should be arranged so that they will distribute forces as equally as possible to several surfaces of the product and the container. Wood or wood products, plastics, and compressed paper products are the most frequently used blocking materials.
- (g) Absorption and Adsorption. In absorption, liquids are drawn into and tend to fill the spaces in porous material. Cushioning materials which have this quality are used in the packaging of liquids. If the internal container should break, the liquid will be absorbed by its own internal packaging rather than escaping from the container to possibly injure postal personnel and/or damage other parcels.

In adsorption, a thin layer of molecules (such as those found in gases, solutes, and liquids) adheres to the surfaces of solids or liquids with which they come in contact. Adsorbent materials also have the ability to condense or hold other substances to their own surfaces. Some cushioning materials are absorbent but not at all adsorbent.

- (h) Corrosion or Contamination Protection. If a product can be contaminated by dust or foreign particles during shipment, it should first be wrapped in kraft paper or plastic film. If properly sealed, this kind of wrapping will offer enough protection to keep dust out. The prevention of corrosion during shipping, however, usually involves keeping intact the protective coating commonly put on metal parts, or maintaining the integrity of vapor-inhibitors or desiccants near the product. Cellulose acetate or polyethylene-coated kraft papers, plastic films, and other specially treated papers may serve well to shield original protective coatings, but should be tested before use.

II. SELECTION FACTORS FOR INTERNAL PACKAGING MATERIALS

(a) Characteristics of the Item Being Mailed

- (1) Shock Resistance or Fragility. As discussed in detail in Chapter 3, the fragility of an item cannot be determined by looking at it. Either a few tests should be applied to a sample of the products, or someone with intimate knowledge of the product's characteristics should be consulted about its fragility. The possibility of the product's being subjected to vibration during transportation must not be ignored.
- (2) Size. A large item may need less cushioning than a smaller one of equal weight. The larger product will generally distribute the load and apply less weight per square inch to the walls of the container.
- (3) Weight. The weight of an item will determine to a large extent the thickness, quantity, and firmness of cushioning material needed. Heavier goods require more and firmer (denser) cushioning.
- (4) Shape. An item with regular contours will usually fit into a standard container with a minimum of cushioning. Irregularly shaped items, on the other hand, will require pads or cells or other cushioning to fill them out to more nearly regular contours. Small, light-weight items with irregular contours can often be simply wrapped in cushioning material and placed in a box or tube. Large items with sharp points or bulges may have to be blocked or braced to prevent concentrated loads on the sides of the container.
- (5) Surface Finish. Some cushioning materials are abrasive, others may induce a chemical reaction with the surfaces of the product. The mailer should take care in selecting his cushioning materials to make sure that the goods and packing are compatible under all circumstances, including changes in the moisture content of the atmosphere (relative humidity).
- (6) Possible Disassembly. Some very irregularly shaped items can be packaged much more simply if the product is taken apart or disassembled. If disassembly is possible, and the receiver can reassemble easily, the components can probably be cushioned more easily. It may even be possible to reduce the total size of the parcel.

(b) General Characteristics of Internal Packaging Materials

- (1) Compression Set is the difference between the original thickness of internal packaging material before it is compressed and its thickness after it has been released from a compressive load. In more formal terms, compression set is the amount of deformation that occurs in material over time from the application of an external force. Permanent compression set is undesirable in internal packaging materials because it allows free movement space to develop in the container.

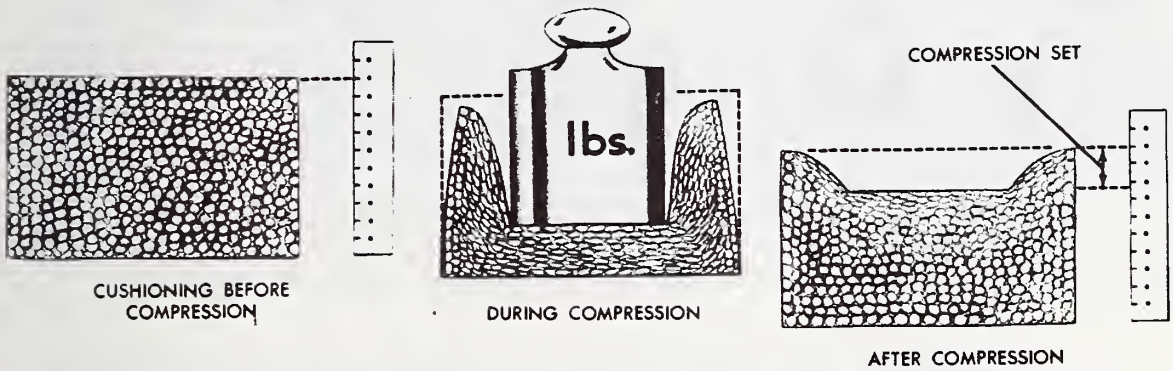

(U.S. Dept. of Defense)

Figure B-4. Characteristics of internal packaging: Compression Set.

- (2) Resiliency. The ability of a material to accept a series of shocks or compressive loads and return to its original shape and thickness is resiliency. Few materials are initially highly resilient, and repeated shocks and changes in temperature will reduce the ability of the material to return to its original thickness. Rubber, for example, is highly resilient under normal temperatures. In extreme cold, however, it becomes hard, and in extreme heat it becomes sticky and sluggish.



(U.S. Dept. of Defense)

Figure B-5. Characteristics of internal packaging: Resiliency.

- (3) Rate of Recovery. The rate of recovery is the time needed for an internal packaging material to return to its original shape after compression. With some materials the rate of recovery is very rapid and the product will bounce. In certain forms, rubber has this characteristic.

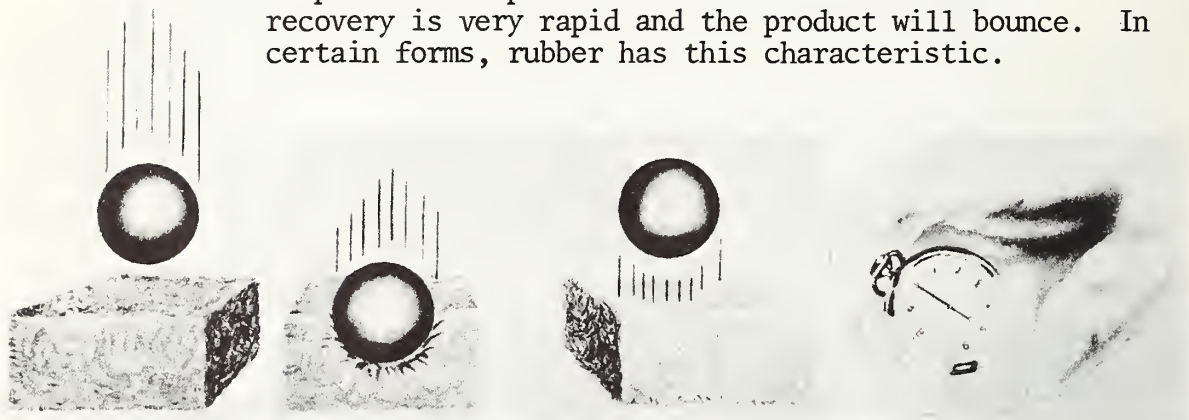

(U.S. Dept. of Defense)

Figure B-6. Characteristics of internal packaging: Rate of Recovery.

- (4) Damping. When a packaging material absorbs the energy from shocks or vibrations, the forces are said to be damped.
- (5) Abrasion is the process of wearing away or eroding a by rubbing or friction. Soft finishes on furniture, for example, and precision surfaces such as those found on optical instruments are subject to abrasion from some internal packaging materials.

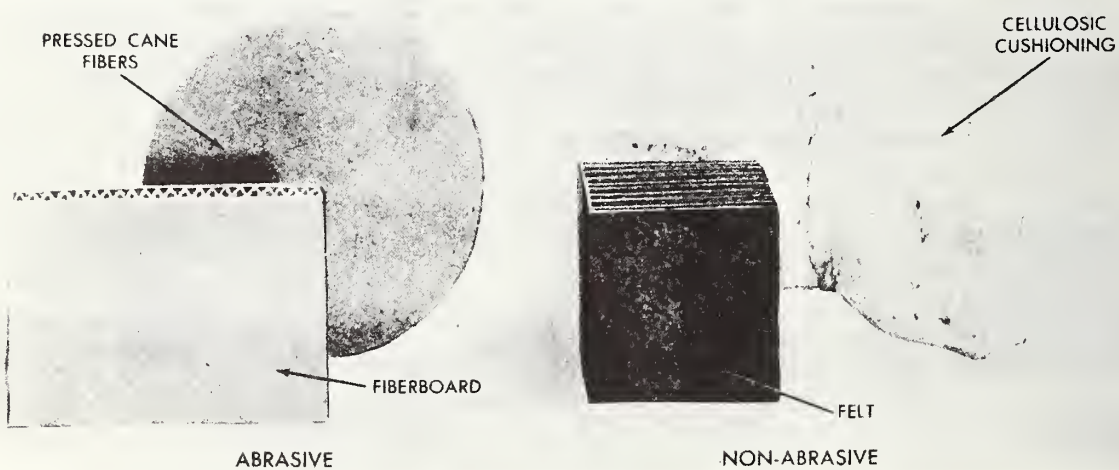

(U.S. Dept. of Defense)

Figure B-7. Characteristics of internal packaging: Abrasiveness.

- (6) Corrosion effects from some internal packaging materials are undesirable. The chemical compounds released by some types of packaging materials when they become moistened must be considered. A neutral wrap or liner will shield vulnerable surfaces if necessary.



(U.S. Dept. of Defense)

Figure B-8. Characteristics of internal packaging: Corrosion.

- (7) Fungus Resistance. Spores of mold, mildew, and other fungi are always present in the air about us. Some packing materials have been prepared so that they will inhibit the growth of fungi during shipment. Others can be readily treated by the mailer to make them fungus resistant. Treated surfaces, however, may have a corrosive effect on metals, so contact between such surfaces should be prevented.

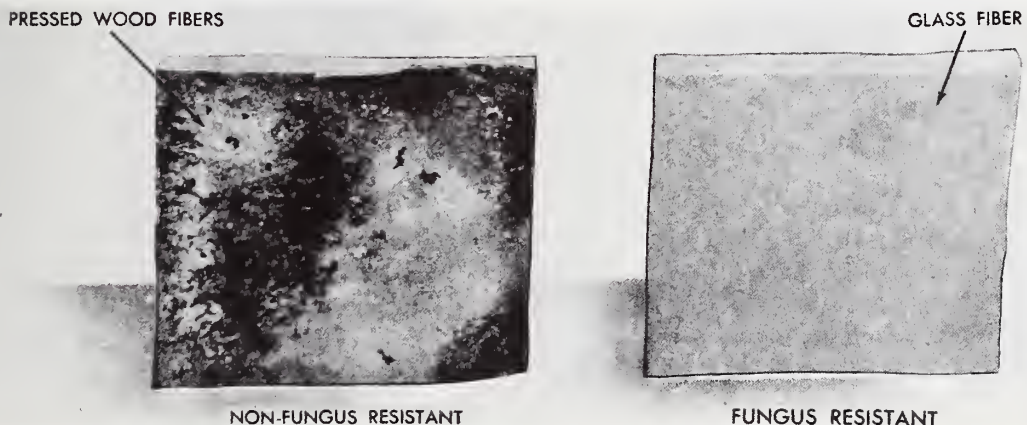

(U.S. Dept. of Defense)

Figure B-9. Characteristics of internal packaging: Fungus Resistance.

- (8) Temperature Performance. The performance of some packing materials is strongly affected by changes in temperature. Plastics, for example, harden at low temperatures and grow soft with heat. If merchandise is shipped to very cold climates or is transported in aircraft with unheated cargo space, packing materials that will remain soft and resilient at low temperatures should be chosen.

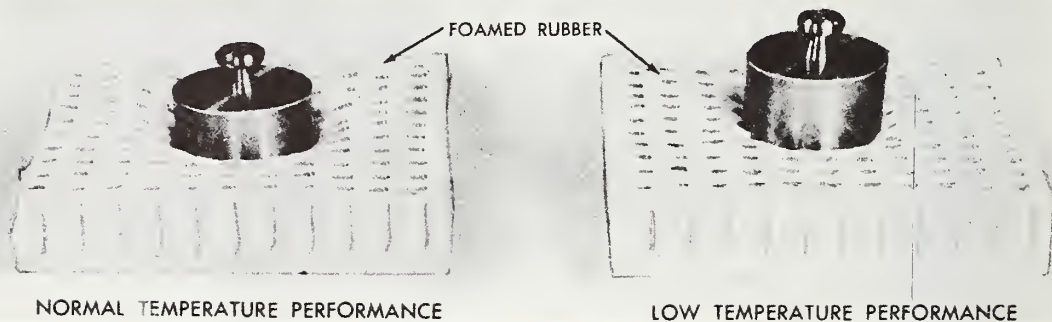

(U.S. Dept. of Defense)

Figure B-10. Characteristics of internal packaging: Temperature Performance.

- (9) Dusting. Dusty packaging materials can contaminate the contents of the parcel. If dust or foreign matter can damage the goods, then the mailer must either wrap the product with preventive material or use another internal packaging material.

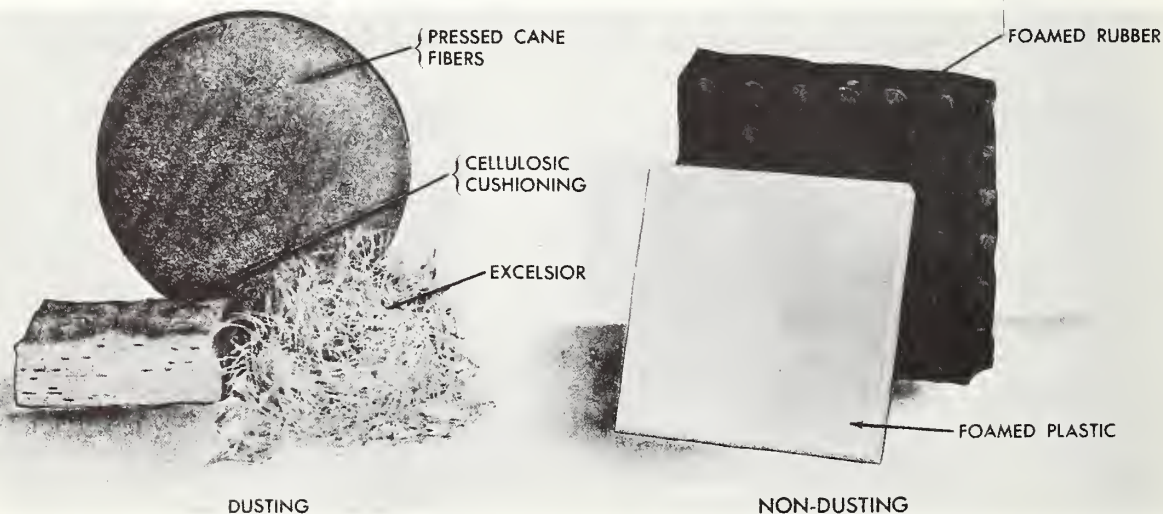

(U.S. Dept. of Defense)

Figure B-11. Characteristics of internal packaging: Dustiness.

- (10) Other Characteristics. Fire resistance or degree of flammability, possible chemical reactions between packing and product, tensile strength of packaging material, and environmental conditions such as high humidity should not be neglected in choosing internal packaging materials.

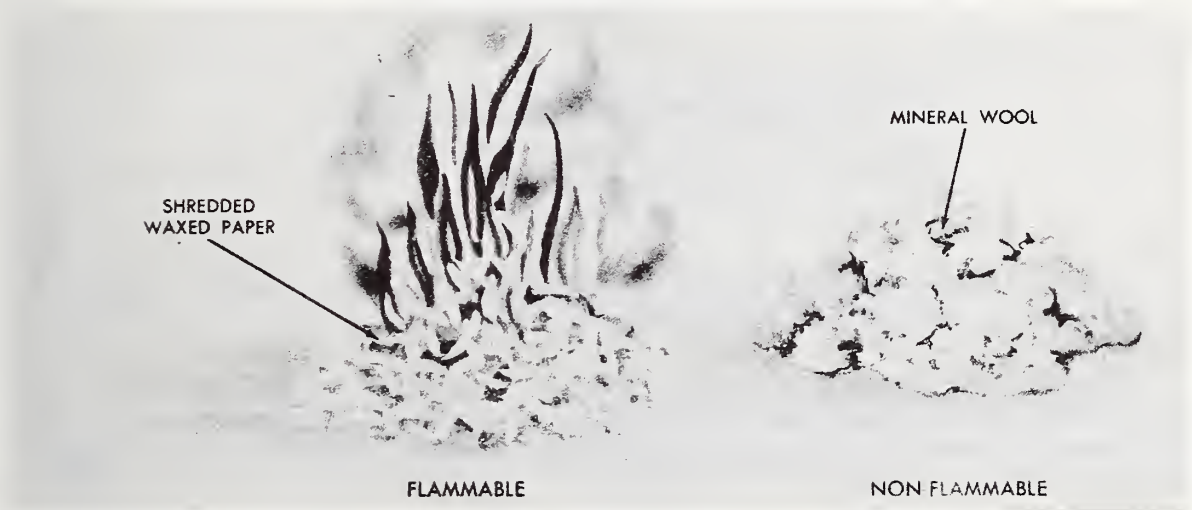

(U.S. Dept. of Defense)

Figure B-12. Characteristics of internal packaging: Flammability.

APPENDIX C

PACKAGING, PACKING AND MARKING

U.S. GOVERNMENT PUBLICATIONS RELATING TO PARCEL POST SHIPPING (FOR GUIDANCE ONLY)

The Government Specifications listed herein are considered useful for guidance in parcel post shipments.

Federal Specifications and Standards. Copies of Federal Specifications may be obtained upon application, accompanied by money order or coupon, or cash, to the nearest Business Service Center of the General Services Administration.

Military Specifications, Standards and Handbooks. Military publications of this kind may be requested from the Naval Publications and Forms Center, 5801 Tabor Ave., Philadelphia, PA 19120.

SECTION I

ADHESIVES, GLUES, AND CEMENTS

Federal

MMM-A-178	Adhesive, Paper Label, Water Resistant
MMM-A-179	Adhesive; Paper Label, Water Resistant, Water Emulsion Type
MMM-A-250	Adhesive, Water-Resistant (For Sealing Fibreboard Boxes)
MMM-A-260	Adhesive, Water-Resistant (For Sealing Waterproofed Paper)

SECTION II

BARRIER MATERIALS

Federal

L-P-378	Plastic Film, Polyethylene Thin Gauge
PPP-B-1055	Barrier Material, Waterproof Flexible

Military

MIL-B-121	Barrier Material Grease Proofed, Flexible (Waterproofed)
MIL-B-131	Barrier Material Water-Vaporproof Flexible, Heat-Sealable
MIL-A-148	Aluminum Foil
MIL-L-10547	Liners, Case, and Sheet Overwrap; Water-Vaporproof or Waterproof, Flexible
MIL-B-13239	Barrier Material, Waterproofed, Flexible All Temperatures
MIL-P-20293	Paper, Kraft, Asphalt Impregnated

SECTION II

BARRIER MATERIALS (CONTINUED)

Military

MIL-F-22019 Film Transparent, Flexible, Heat Sealable, Volatile, Corrosion Inhibitor Treated

MIL-F-22191 Film, Transparent, Flexible, Heat Sealable, For Packaging Application

MIL-B-81374 Barrier Material, Greaseproof, Waterproof, Flexible, High Strength

SECTION III

CONTAINERS, INTERIOR

Federal

PPP-B-15 Bags, and Envelopes Cellophane for Packaging

PPP-B-20 Bags, Cotton Mailing

PPP-B-566 Boxes, Folding, Paperboard

PPP-B-636 Boxes, Fibreboard

PPP-B-676 Boxes, Set-Up, Paperboard

PPP-C-55 Cans, Fibreboard and Paperboard, (With Paper and Metal Ends)

PPP-C-96 Cans, Metal, 28 Gage and Lighter

PPP-E-1533 Envelope, Packaging, Corrugated Fibreboard, Cushioned

PPP-S-30 Sacks, Shipping, Paper (Cushioned)

PPP-S-1927 Sack, Shipping, Paper Reinforced

PPP-S-001933 Sack, Shipping, Paper, (Utility)

Military

MIL-B-117 Bags and Sleeves, Interior Packaging

MIL-B-137 Bags and Sacks for Packaging and Packing of Subsistence Items

SECTION III

CONTAINERS, INTERIOR (CONTINUED)

Military

MIL-T-3955 Cans, Fibre, Spirally Wound
MIL-C-4470 Cans, Metal, Reusable, Rectangular
MIL-B-22020 Bags Transparent, Flexible, Sealable
Volatile Corrosion Inhibitor Treated

SECTION IV

CONTAINERS, EXTERIOR

Federal

PPP-B-20 Bags, Cotton Mailing
PPP-B-585 Box, Wood Wirebound
PPP-B-591 Box, Fibreboard, Wood-Cleated
PPP-B-636 Box, Fibreboard
PPP-C-186 Containers, Packaging and Packing for
Drugs, Chemicals and Pharmaceuticals
PPP-B-1163 Box, Corrugated, Fibreboard, High
Compression Strength, Weather Resistant,
Wax Resin Impregnated
PPP-C-1266 Container, Thermal, Shipping, For
Medical Material Requiring Controlled
Temperature Ranges
PPP-B-1364 Box, Corrugated Fibreboard, High Strength,
Weather Resistant, Double-Wall
PPP-S-30 Sacks, Shipping, Paper (Cushioned)
PPP-S-1927 Sack, Shipping, Paper, Reinforced
PPP-S-001933 Sack, Shipping, Paper (Utility)

Military

MIL-C-43369 Container Assembly, Sample and Specimen
Shipping, Box Type, For Meat and Dairy
Products Sample

SECTION V

CUSHIONING MATERIALS

Federal

PPP-C-795	Cushioning Material, Flexible, Cellular Plastic Film For Packaging Applications
PPP-C-843	Cushioning Material, Cellulosic
PPP-C-850	Cushioning Material, Polystyrene, Expanded, Resilient (For Packaging Uses)
PPP-E-911	Excelsior, Wood, Fabricated Pads and Bulk Form
PPP-C-1120	Cushioning Material, Uncompressed Bound Fibre For Packaging
PPP-C-1752	Cushioning Material, Packaging, Unicellular Polyethylene Foam, Flexible.
PPP-C-1797	Cushioning Material, Resilient, Low Density, Unicellular, Polypropylene Foam
PPP-C-1842	Cushioning Material, Plastic, Open Cell, (For Packaging Applications)
PPP-F-320	Fibreboard; Corrugated and Solid Sheet Stock (Container Grade) and Cut Shapes
PPP-P-115	Pads, Paper, Macerated
PPP-P-150	Paper, Shredded, Waxed
PPP-P-291	Paperboard, Wrapping, Cushioning
<u>Military</u>	
MIL-F-2312	Felt Hair or Wood
MIL-B-3106	Board; Composition, Water Resistant Solid (For Filler or Cushioning Pads)
MIL-R-5001	Rubber, Latex Foam Sponge
MIL-H-9884	Honeycomb, Material, Cushioning, Paper

SECTION V

CUSHIONING MATERIALS (CONTINUED)

Military

MIL-C-17435 Cushioning Material; Fibrous Glass

MIL-P-19644 Plastic Foam Molded Polystyrene
(Expanded Bead Type)

MIL-R-20092 Rubber Sheets and Molded Shapes Cellular,
Synthetic, Exploded Cell (Foamed Latex)

MIL-C-23734 Cushioning Material, Cellulosic, Treated,
Free Flow, Tubular

MIL-P-26514 Polyurethane Foam, Rigid or Elastic,
For Packaging

MIL-C-26861 Cushioning Material Resilient Type,
General

MIL-F-26862 Fibreboard, Solid, Noncorrosive, Fungi-
Resistant for Interior Blocking Appli-
cations

MIL-F-81334 Foam, Plastic, Flexible, Open Cell,
Polyester Type, Polyurethane

Military Handbook

MIL-HDBK-304 Packaging Cushioning Design

SECTION VI

DESICCANTS AND HUMIDITY INDICATORS

Military

MIL-D-3464 Desiccants (Activated) in Bags; For
Static Dehumidification and Packaging
(QPL 3464)

SECTION VI

DESICCANTS AND HUMIDITY INDICATORS (CONTINUED)

Military Standards

MS-20003	Indicator--Humidity, Card, Three Spot Impregnated Area
MS-26507	Indicator, Card, Desiccant Relative Humidity (8% ± 5%)

SECTION VII

ENVELOPES

Federal

PPP-E-540	Envelopes; Water Resistant, For Packing List and Shipping Documents
PPP-E-1533	Envelope, Packaging, Corrugated Fibre-board, Cushioned

Military

MIL-E-6060	Envelope, Packaging, Water Vaporproof, Flexible
------------	---

SECTION VIII

MARKING AND MARKING EQUIPMENT

Federal

H-B-621	Brush; Stencil
GG-S-747	Stencil-Cutting Machine, Hand Operated
TT-I-1795	Ink, Marking, Stencil, Opaque (Porous and Non-Porous Surfaces)
UU-L-49	Labels, Paper, Gummed
UU-T-81	Tags; Shipping and Stock

SECTION VIII

MARKING AND MARKING EQUIPMENT (CONTINUED)

Military

MIL-L-19896 Labels and Label Tape Pressure
Sensitive Adhesive, Paper, Water
Resistant

Military Standards

MIL-STD-129 Marking for Shipment and Storage

SECTION IX

PACKAGING AND PACKING METHODS

Federal

PPP-P-16 Packaging of Photographic Dry
Chemicals, General Specifications
for

PPP-C-29 Canned Subsistence Items, Packaging
and Packing of

PPP-P-40 Packaging and Packing of Hand Tools

PPP-P-50 Packaging and Packing of Thread
for Domestic and Overseas Shipment

PPP-C-300 Chemicals, Liquid, Packaging and
Packing of

PPP-C-301 Chemicals, Dry and Paste, Packaging
and Packing

PPP-H-1581 Hardware (Fasteners and Related Items)
Packaging and Packing For Shipment
and Storage

PPP-I-350 Individual Servings of Subsistence;
Packaging and Packing of

PPP-T-360 Time Measuring Instruments Packaging of

SECTION IX

PACKAGING AND PACKING METHODS (CONTINUED)

Federal

- PPP-G-460 Glass Containers, One Gallon Cap and Smaller, for Other Than Medicinal Products; Packaging and Packing of
- PPP-T-680 Tape, Pressure Sensitive Adhesive, Packaging and Packing of
- PPP-T-681 Tape, Gummed, Packaging and Packing of
- PPP-P-1148 Packaging and Packing of Typewriters
- PPP-T-1150 Tools and Tool Accessories for Power Driven, Metal and Woodworking, Machinery; Packaging and Packing of

Federal Standards

- FED-STD-75 Glossary of Packaging Terms
- FED-STD-101 Preservation, Packaging and Packing Materials, Test Procedures

Military

- MIL-V-3 Valves, Fittings and Flanges, Packaging of
- MIL-E-75 Electron Tube, Preparation for Delivery of
- MIL-P-116 Preservation; Methods of
- MIL-R-196 Repair Parts for Internal Combustion Engines Packaging of
- MIL-B-197 Bearings, Anti-Friction, Associated Parts and Subassemblies; Packaging of
- MIL-B-208 Battery, Storage, Lead Acid, Automotive and Navy Portable (Except Aircraft), Packaging and Packing of

SECTION IX

PACKAGING AND PACKING METHODS (CONTINUED)

Military

MIL-H-775	Hose, Rubber or Fabric (Including Tubing); and Fittings, Nozzles and Strainers Packaging of
MIL-P-1470	Packaging and Packing of Prepared (Ready to Eat) Premixed and Uncooked Breakfast cereals
MIL-C-3131	Cordage; Preparation for Delivery of
MIL-P-3816	Abrasives and Abrasive Products for Shipment and Storage, Packaging and Packing of
MIL-P-6063	Packaging of Batteries, Storage, Charged and Dry-Uncharged and Moist, General Specification for
MIL-P-10430	Welding Rods and Electrodes, Preparation for Delivery of
MIL-P-14527	Pole Line Hardware, Preparation for Delivery of
MIL-O-16898	Optical Elements; Packaging of
MIL-R-17207	Repair Parts for Time Measuring Instruments; Packaging of
MIL-E-17555	Electronic and Electrical Equipment and Associated Repair Parts, Preparation for Delivery of
MIL-S-19491	Semi-Conductor Device, Packaging of
MIL-C-39028	Capacitor, Packing of; General Specification for
MIL-R-39032	Resistor, Packaging of
MIL-W-43334	Webbing & Tape, Textile Packaging and Packing of

SECTION IX

PACKAGING AND PACKING METHODS (CONTINUED)

Military

MIL-L-43432 Leather, Packaging and Packing of

MIL-W-45562 Welding and Soldering Equipment Supplies
and Accessories Packaging of

MIL-B-55521 Batteries, Dry, Packaging and Packing of

MIL-C-55442 Cable Assemblies and Cord Assemblies,
Packaging of

MIL-M-55565 Microcircuits, Packaging of

Military Standard

MIL-STD-794 Parts and Equipment, Procedures for
Packaging and Packing of

MIL-STD-1186 Cushioning, Anchoring, Bracing, Blocking
and Waterproofing; with Appropriate Test
Methods Superseding

Military Standards

MS-27757 Pack, Instrument, with Star Design
Polyurethane Cushioning Insert

SECTION X

STRAPPING AND STRAPPING EQUIPMENT

Federal

QQ-S-781 Steel Strapping; Flat

QQ-S-790 Steel Strapping; Round, Bare and Zinc-Coated

PPP-S-760 Strapping, Nonmetallic (and Closure Seals)

PPP-T-97 Tape; Pressure-Sensitive Adhesive, Filament
Reinforced

SECTION X

STRAPPING AND STRAPPING EQUIPMENT (CONTINUED)

Military

MIL-S-17743 Stretcher, Steel Strapping, Hand
MIL-S-43180 Sealer, Steel Strapping, Hand, Non-Powered
MIL-S-43361 Stretching and Sealing Machine, Strapping
Hand

SECTION XI

TAPE

Federal

L-T-90 Tape, Pressure-Sensitive, Adhesive
(Cellophane and Cellulose Acetate)
L-T-100 Tape, Pressure-Sensitive Adhesive,
Polyester Film
PPP-T-42 Tape, Pressure-Sensitive Adhesive;
(General Packaging Application)
PPP-T-45 Tape, Gummed, Paper Reinforced
PPP-T-60 Tape, Pressure Sensitive Adhesive,
Waterproof, for Packaging (QPL 60)
PPP-T-76 Tape, Pressure Sensitive Adhesive,
Paper, Water Resistant
PPP-T-97 Tape; Pressure Sensitive Adhesive,
Filament Reinforced

Military

MIL-T-43036 Tape, Pressure Sensitive Adhesive,
Plastice Film, Filament Reinforced
(for Sealing Fibre Containers and Cans)

SECTION XII

WRAPS

Federal

UU-P-268 Paper; Kraft, Wrapping
PPP-B-1055 Barrier Material, Waterproof, Flexible
PPP-P-291 Paperboard, Wrapping, Cushioning

Military

MIL-P-130 Paper, Wrapping, Laminated and Creped
MIL-P-3420 Packaging Materials, Volatile Corrosion
Inhibitor Treated, Opaque
MIL-P-17667 Paper, Wrapping, Chemically Neutral
(Non-Corrosive)
MIL-B-13239 Barrier Material, Waterproofed, Flexible,
All Temperatures
MIL-P-20293 Paper, Kraft, Asphalt Impregnated

SECTION XIII

CLOSING, SEALING AND REINFORCING

Federal Standard

FED-STD-224A Closing, Sealing and Reinforcing of Fibre-
board Shipping Boxes, General Methods for

SECTION XIV

PACKAGING, GENERAL

Military

MIL-HDBK-304 Military Standardization Handbook Package
Cushioning Design
DSAM 4145.2 Vol. II Preservation Packaging, and Packing of Military
Supplies and Equipment

SECTION XV

TESTING

American Society for
Testing & Materials (ASTM)

D 775-61	Drop Test
D 999-68	Shaker Test
D 782-68	Revolving Drum Test

GLOSSARY

- Abrasion - The process of wearing, grinding, or rubbing away the surface of a product or package by friction.
- Absorbent material - Material capable of taking or soaking up liquids, such as blotting paper, paper towels, paper napkins, sponges, etc.
- Absorbent packing - The inclusion of absorbent material within a package to take up liquids resulting from leakage of the contents.
- Adhesion - The process of enabling two adjacent surfaces to be bonded together.
- Adhesive - A fluid material to be spread on one or both surfaces to be bonded together, turning into a solid or semi-solid material when bonding takes place.
- Adsorption - A concentration of a substance at a surface resulting from a thin layer of molecules, such as those found in gases, solutes and some liquids, that adheres to the surface of solids or liquids with which they come in contact.
- Basket, wooden - A container made of interwoven strips of wood crossed at right angles, commonly bound at the top.
- Blister, packs - A type of plastic packaging, permitting visual inspection.
- Blocking - The process of maintaining objects or items in a fixed position during transit by bracing them against each other or against the sides of the container with the use of such materials as blocks, wood strips, etc.
- Boxboard - A general term designating the types of paperboard used for making folding cartons.
- Box, corrugated and solid fiber - A three dimensional container, made either of solid fiberboard or of corrugated fiberboard.
- Boxes, crates - A rigid container constructed of slats of wood fastened together to protect the contents.
- Boxes, wood - A rigid container made of wood with closed faces found in several standard types.
- Bracing - The process of supporting units within a package to prevent damage through movement.
- Brick-laid - See Loading, Brick-wall, Method of
- Bursting strength - The force required to rupture a container specimen when it is tested under specified conditions with specified instrumentation. Bursting strength is largely determined by the tensile strength and extensibility of the paper or paperboard, and is commonly used as a measurement of the strength of paper or paperboard.
- Can, composite - A rigid container commonly constructed with the body of fiberboard and one or both ends of metal.
- Can, fiber - A rigid container constructed almost completely of lightweight fiber stock, which may be lined or treated with ends of paperboard, metal, or of other material; use primarily as an interior packaging container.
- Can, metal - A rigid container usually made of tin, steel, aluminum or combinations of the three.

Cartons, folding - A closed container made of bending grades of paperboard, cut and creased, in a variety of sizes and shapes. These cartons are usually folded and delivered in, or collapsed form by the manufacturer to be set up, filled and closed by the user.

Closure - A sealing or covering device affixed to or on a container for the purpose of retaining the contents and preventing contamination thereof.

Combustion, spontaneous - The outbreak of fire in combustible material (such as oily rags or damp hay) that occurs without the direct application of a flame or a spark, usually caused by slow oxidation processes under conditions that do not permit the dissipation of heat.

Compression set - The amount of deformation that occurs to a cushioning material over time by application of external forces which tend to depress the material; usually the difference between the original thickness of the material after the force has been removed.

Contamination - The process of soiling, staining, or otherwise harming a product by having foreign matter or materials come into contact with the product.

Corrosion - The process of wearing away a material usually by chemical action.

Corrugated - Having flutes, furrows, ridges, or grooves; forming a wavy surface with added rigidity.

Corrugated fiberboard (single face) - Material that has a single layer of corrugated medium glued to a single piece of facing paper.

Corrugated fiberboard (single wall) - Material formed by having one layer of corrugated medium glued between two pieces of facing material.

Corrugated fiberboard (double wall) - A material characterized by combining two, single-walls together in sandwich fashion except that only three pieces of facing material are needed.

Corrugated fiberboard (triple wall) - A material characterized by combining three, single-walls together in sandwich fashion except that only four pieces of facing materials are needed.

Creep - The slow change of dimension of an object from prolonged exposure to high temperature or stress.

Cushion factor - The dimensionless ratio of maximum stress that an item can withstand to the corresponding energy absorption per unit volume of cushioning material.

Cushioning - A means of protecting items from physical damage by placing about their outer surfaces materials that have been designed to absorb or distribute the shock or reactions caused by external forces.

Dampen - to diminish vibration or oscillation.

Damping, critical - The minimum viscous damping that will allow a displaced system to return to its initial position without oscillation.

Density - The weight per unit volume.

Displacement - A vector quantity describing the change of position of a body, point, or surface relative to a fixed reference point.

Drum, fiber - A rigid, cylindrical, shipping container with straight sides, made of paperboard; used as shipping container for dry powders, dry solids, and liquids.

Effective load bearing area - The projected area of the item in the direction of impact.

Elasticity - The force-displacement characteristic of a material.

Electricity, static - A stationary electrical charge on the surface of an object.

Five panel folder - A corrugated or solid fiberboard box creased and cut such that, when folded and assembled, several thicknesses of fiberboard are present at each end. This container provides considerable strength for long articles.

Flashpoint - The minimum temperature at which sufficient vapor, is released by a liquid or solid to form a flammable vapor-air mixture at atmospheric pressure.

Flute - A rib or corrugation on a surface; one of the wavy, curving forms of a corrugated material. Fluting can differ in size, thickness, and the number per foot.

Folders, (one, two, and three piece) - Containers made from either corrugated or solid fiberboard by folding either one, two, or three pieces of creased sheets.

Fragility - The ability of a product or package to withstand changes in velocity, impact and vibration.

Frequency - The reciprocal of the period of periodic oscillation.

Frequency, natural - The frequency of free oscillation of a system.

Full flap slotted container (FFSC) - Resembling a regular slotted container except that the outer flaps completely overlap instead of meeting at the center. Container made from either corrugated or solid fiberboard.

"G" factor - Impact force relative to normal acceleration due to gravity. Measurement for the shock resistance of an item; used by a packaging engineer when devising the proper cushioning in a package.

Harmful matter - Any article, device, composition, material, plant, insect, animal, etc., due to its own force, nature, or chemical or mechanical characteristics that could be dangerous or injurious to life, health, or property. Includes Hazardous Material, Quarantined Matter, Perishables, and Special Legals.

Hazardous material - Articles or substances due to its chemical or mechanical characteristics that could be dangerous or injurious to life, health, or property (see Harmful Matter).

Hysteresis - The lagging of one of two related forces or phenomena on account of some change taking place in the medium through which they act.

Immobilize - To reduce or eliminate movement of an item or product within a container.

Insulation - The process of preventing the transfer of electricity, heat, sound, etc.

Joint, manufacturer's - The seam of a corrugated or solid fiberboard box where the two edges of the box blank are joined by stitching, taping, or gluing by the box manufacturer.

Loading, brick-wall method - A method of loading packages into containers by which the packages are stacked neatly in a lengthwise and crosswise manner, with heavier packages toward the bottom of the container.

Mullen test - This test is widely used on paper packaging materials to determine the relative burst strength. A rubber diaphragm of about 1 sq. in. of surface area is forced against the sample specimen firmly held in metal clamps. The pounds required to cause paper, paperboard or other material to burst are recorded in pounds per square inch or "points".

Nesting - Cushioning of a series of similar items with intermediate layers of cushioning material.

Nonmailable matter - Matter, which is by law, postal regulation, or treaty stipulation, prohibited from being sent in the mail because its either "harmful" or "objectionable". (See Harmful Matter and Objectionable Matter.)

Objectionable matter - Any matter, thing, publication, advertisement, etc. considered objectionable by a receiver because it is scurrilous, defamatory, libelous, threatening, filthy, lewd, or primary sexual in nature.

Overlap slotted container (OSC) - Container resembling a regular slotted container except that the outer flaps overlap, usually about 2 inches. Container made either of corrugated or solid fiberboard.

Pad, corner - A three-sided cushion used at an interior corner of a shipping container to protect a regularly shaped item or internal container.

Pad, side - A cushion that is applied adjacent to the side of an item or internal container in a package. Side pads are usually appreciably smaller than the sides of the items or containers that they bear against.

pH - As applied to a cushioning material, a symbol commonly denoting the acidity or alkalinity of a material.

Pails, steel - A rigid, single-walled, cylindrical container of 1-15 gallons capacity, constructed of steel sheet, 29 gauge or heavier.

Pulse rise time - The interval of time required for the leading edge of a pulse to rise from some specified small fraction to some specified larger fraction of the maximum value. (Frequently, "rise time" is taken to include the time required to increase from 1/10 to 9/10 of the maximum value.)

Recovery ability - The ability of a cushioning material to regain its original dimensions following removal of a load causing deformation.

Regular slotted container, (RSC) - Container having outer flaps of the same length and meeting in the center; inner flaps do not meet unless length and width are the same. Container made from either of corrugated or solid fiberboard.

Reinforcing - The strengthening of containers and packages by the use of encircling bands girthwise, lengthwise and horizontally around a box or by the use of strips of tape over edges.

Resilience - The ability of an internal packaging material to withstand temporary deformation without permanent deformation or rupture.

Retention - The process of keeping a product in place and restraining or containing it from moving about within the container.

Rule 41 - Section of the Consolidated and Uniform Freight Classifications, governing bursting strength, maximum dimensions, maximum gross weight and other requirements of solid and corrugated fiberboard boxes and fiber drums for rail freight shipment of non-dangerous articles.

Separations - Internal packaging materials designed to maintain space between unit packs or multipart products being shipped within a parcel or container, e.g., corrugated fiberboard, molded pulp, foam slabs, vacuum formed plastic materials, etc.

Shock - A sudden, nonperiodic excitation of an object or system.

Shock pulse - A disturbance characterized by a rise and decay of acceleration from a constant value in a short period of time. Shock pulses are normally displayed graphically as curves of acceleration vs. time.

Strain - Deformation per unit length.

Stress - Force per unit area.

Suspension packing - Method of internally packaging the contents so that they "hang" free of one or more sides of the container.

Telescopic box (full) - A corrugated or solid fiberboard container consisting of two sections of equal height, one fitting over the other.

Tensile strength - The resistance of a material to longitudinal tension stress; the relative ability of paper or board to resist tearing apart under tension.

Transmissibility - The nondimensional ratio of the response amplitude of a system in steady-state forced vibration to the excitation amplitude. The ratio may involve accelerations, forces, displacements or velocities.

Tube, mailing composite - A cylindrical container spirally wound with solid fiberboard which may or may not have a closure on the ends.

Unitized load - A load of parcel in which all of the parcels are bound together in one or more units.

Velocity - A vector quantity describing the time rate of change of displacement of a body in relation to a fixed reference point.

Vermiculite - A highly water-absorbent internal packaging material usually used in packaging liquids.

Vibration - The oscillation of an element of a mechanical system about a suitable reference point.

Wadding - Fibrous masses or pads used as an internal cushioning material.

INDEX

- Addresses, 3, 144-151
 - contrast, 144
 - general considerations, 54, 56, 64, 65, 144, 145
 - label attachment, 146-148
 - print size, 144
 - spacing, 144
 - tags, 148
- Adhesives, 36, 119-121, 147, 148
 - application of, 119-121, 147, 148
 - casein, 119
 - glue, 147
 - liquefied glue, 119, 147
 - pressure-sensitive, 148
 - protein-derived, 119
 - starch-derived, 119
 - synthetic resin, 120
 - emulsions, 120
 - hot melts, 120
 - latex, 120
 - solvent activators, 120
 - thermoplastic, 148
- Aerosols, 7
- Animals (dead or alive), 10-12, 54, 57
- Articles, mailable under special rules, 55-60
- Automotive Parts, 7
- Availability, packaging components, 152, 153
 - professional organizations, 152
 - trade associations, 152
 - trade journals, 152
- Bags, 19-21, 25, 88-91, 96
 - cushioned paper, 20
 - padded shipping, 88, 89
 - plastic bags, 90, 91, 96
 - plastic bubble cushioning, 21, 90
 - polyethylene foam, 89
 - single-walled corrugated, 19
 - textile, 25
- Banding, 3, 40, 62, 139-142
 - metal, 40, 139-141
 - sizes, 140
 - plastic, 40 142
- Bookpack, 19
- Books, 7, 41, 62
- Box, cleated plywood, 23
- Box, wooden, 22, 82
- Cans, 24, 79-81, 96, 142
- Chemicals, 57
- Clips, metal, 40, 59, 78, 80
- Closures, 2, 3, 36-40, 59, 77, 118-143
- Combustibles, 8, 55, 57, 58
- Containers, 15-25, 58-60, 77-93
 - box with cover, 16
 - breakable, 58-60, 143
 - five panel folder, 18, 135
 - full overlap slotted, 16, 136
 - full telescope, 17, 85, 88, 136
 - liquids, 58-60
 - nonbreakable, 58
 - one, two, and three-piece folders, 18, 134
 - overlap slotted, 15, 123
 - partial telescope, 17, 85
 - regular slotted, 16, 84, 123, 132-134
- Containers, external, 2, 15-25, 56, 60, 68, 76, 77-93
 - combination, 77, 92
 - flexible, 77, 88-92
 - bags, 19-21, 25, 88-91, 96
 - envelopes, 91
 - heavy duty, 90, 91
 - shrink wraps, 91, 92, 97
 - miscellaneous, 77, 92, 93
 - overwraps, 93
 - rigid plastic, 92
 - wraps, 93
 - rigid, 60, 61, 77-82
 - baskets, wooden, 82
 - boxes, wooden, 22, 82
 - cans, composite, 80, 142
 - cans, fiber, 24, 79
 - cans, metal, 24, 81
 - crates, wooden, 22, 82
 - drums, fiber, 24, 78, 79
 - pails, steel, 81
 - tubes, composite, 25, 63, 80, 142, 143
 - semi-rigid, 77, 83-88
 - boxboard folding cartons, 85
 - boxes, corrugated fiberboard, 83-84
 - boxes, set-up, 86-88
 - boxes, solid fiberboard, 84

- Containers, internal, 56, 58, 96, 97
 breakable, 58-60
 liquids, 58-60
 nonbreakable, 58, 96, 97
- Corrugated fiberboard, 26, 60, 83, 106, 117-118
 double-wall, 26
 paper, 88
 single-wall, 26
 triple-wall, 26
- Cosmetics, 8
- Costs, 42-45
 labor, 43
 material, 43
 postage, 43
 storage, 44
- Crate, wooden, 82
- Cuffs, 40, 80, 142, 143
- Cushioning, 2, 46, 56, 68, 93-114, 162, 163
 hair, rubberized, 34, 94, 95, 104
 latex coated, non-corrugated, 30, 94, 95, 106, 107
 loose-fill, 31, 94, 95, 110-114
 excelsior, 94, 95, 111
 fiber-glass, 94, 95, 112
 polystyrene, 94, 95, 111
 shredded newspaper, 94, 95, 110
 plastic foam sheeting (polypropylene), 32, 94, 95, 107-109
 polyethylene, 33, 94, 95, 97-100
 polystyrene, expanded, 33, 94, 95, 105-106
 polyurethane, foamed, 33, 94, 95, 101-103
 sealed plastic, container, 35, 93-96
 single-faced, corrugated, 29, 94, 95, 105, 106
 urethane, 33, 94, 95, 101
 vermiculite, 33, 94, 95, 103
 wadding, 30, 31, 94, 95, 113-117
- Density, 45, 46, 63, 66, 68, 78, 113
- Drugs, 8, 55, 57
- Drums, 24, 58, 78, 79, 96
- Drying agents, 71
- Electrical Appliances, Large
 9
- Electrical Appliances, Small
 8
- Electrical Components
 9
- Fabrics, 41, 61
- Feeds, 9
- Fiberboard, 63, 70, 83, 84, 117, 118
 corner pads, 118
 corrugated liners, 118
 corrugated partitions, 118
 flat pads, 118
 folded pads, 118
 open-end cells and trays, 117
- Filmpacks, 21
- Firearms, 9, 55-57
- Flammability, 54, 57, 58, 60
- Flutes, type, 83, 84
- Food, 9, 54, 57
- Fragility, 3, 46-51, 166
 acceleration, 48-50, 68
 concepts, 46
 damage boundary, 48-51, 68
 impact "g" force, 49, 50, 68
 other aspects, 51
 testing for, 48-51
 velocity change, measurement, 48-50, 68
- Furniture, 10
- Furs, 10, 57
- Gaseous Substances,
 8, 55, 57
- Glassware, 10, 60
- Hair Felt, 105
- Hardware, 10
- Harmful matter, 54-56
- Heat Sealable, 89-92, 96, 97, 100
- Hides, 10, 57
- Humidity, relative, 41, 52, 57, 70-75

Infectious matter, 55, 57
 Insects, 57
 Internal Packaging, 2, 3, 26-35, 56,
 59, 64, 65, 68, 71, 77, 93-118,
 162-171
 abrasion, 94, 95, 97, 107,
 111, 168
 absorption, 56, 59, 60, 71, 94,
 95, 101, 103-106, 110, 111,
 115, 117, 165
 adsorption, 165
 blocking, 51, 117, 165
 bracing, 117, 165
 compression-set, 94, 95, 98, 101,
 104, 105, 110-112, 115, 167
 contamination protection, 97, 165
 corrosion, 55, 58, 70, 94, 95,
 104-106, 112, 165, 169
 cushioning, 46, 56, 162, 163
 damping, 94, 95, 111
 dusting, 94-96, 98, 103, 105,
 110, 111, 115, 170
 fungus, resistance, 101, 105,
 110-112, 169
 isolation, contents, 59
 leakage, 58-60
 liquids, 58-60
 moisture resistance, 94-96, 97,
 104-106, 115
 reinforcement and/or support,
 45, 46, 56
 resilience, 94, 95, 97, 98, 101,
 104-106, 110-112, 115
 retention, 59, 60, 164
 separation, 59, 163, 164
 shock resistance, 164-166
 suspension, 79, 105, 164
 temperature performance, 105,
 107, 110-112, 170
 waterproof, 59, 60, 71

 Jewelry, Costume, 101
 Joints, manufacturer, 84

 Knives and other cutting
 instruments, 55, 57

 Labeling, 3, 56, 60, 65, 77,
 146-151
 addresses, 3, 144-151
 contrast, 144
 general considerations, 54, 56,
 64, 65, 144, 145
 label attachment, 146-148
 legibility, 144
 print size, 144
 spacing, 144
 tags, 148
 Laboratory Equipment, 101
 Laboratory Samples, 101
 Length, parcel, 63, 64
 Lids, caps, and/or tops, 59
 Liner pads, corrugated, 27, 96
 Liquids, 11, 41, 57, 58-60
 Locking tabs, 40, 85

 Magnetic Tapes, 61
 Magnets, 41
 Mailability, 52-54, 56-58
 Manufacturer's Joint, 84
 Markings, 151
 Matches, 8, 57
 Medicines, 55, 57
 Musical Instruments, 12

 Nonmailable matter, 52-54, 56

 Objectionable matter, 54

 Packing forms, corrugated, 28
 Pads/Protectors, corners, 29
 Paper Items, documents, 7, 62,
 80, 85, 89
 Paperboard, 80, 85, 86
 Parcel Post system, 1-4
 acceptance, 57, 66, 67
 bulk mail centers, 76
 class of service, 66
 containerization, 76

- environmental influences, 65-76, 155-161
 - compression, 46, 67, 68
 - handling, 1, 41, 52, 65-68, 76
 - humidity, 41, 70-75
 - loading, 67, 68, 70, 71, 76
 - non-machines, 66
 - processing, 1, 65, 66, 68
 - shock, 41, 46, 67, 68, 166
 - temperature, 41, 52, 58, 70-75, 155-161, 170
 - transportation, 52, 65, 67, 70
 - vibration, 2, 41, 46-48, 51, 52, 59, 67-69
- Partitions, corrugated, 27, 118
- Pelts, 10, 57
- Plants, 12, 57
- Poisonous Substances, 55, 57
- Polyvinyl Chloride (PVC), 105
- Powders, 12, 57, 58
- Radioactive Materials, 12, 57
- Rate of recovery, 168
- Recordings, 12
- Recordpack, 22
- Replacement, Cost of, 42
- Resonance, 51
- Responsibility, mailer, 2-4, 6, 41, 52, 53, 56, 58, 64, 66, 67, 70
 - articles mailable under special rules, 55-60
 - harmful matter, 54-56
 - mailability, 52-54, 56-58
 - nonmailable matter, 52-54, 56
 - objectionable matter, 54
- Reuse, aspects of, 44
 - recyclable, 44
 - recycled, 44
 - reusable, 44
- Scientific Instruments, 13
- Seeds, 9
- Shrink Wrapping, 91, 92, 97, 143
- Size, parcel, 41, 54, 58, 63-66, 68, 166
 - product, 41, 58
- Soft goods, 13
- Specifications, Federal and Military, 172-185
- Spoilage, 54, 70
- Sporting Equipment, 13
- Stapling, 39
 - application of, 122, 123
 - sizes, 121
 - styles, 121
- Stitching, uses of, 38, 121-123
- Structure and shape, 3, 46, 66
 - contents, 3, 41, 46
 - flat parcels, 64
 - parcel, 3, 46
 - regularity of shape, 46, 68
- Tapes,
 - application of, 124-129
 - gummed tapes, 124-129
 - nonreinforced, 126
 - storage of, 124
 - pressure-sensitive, 129-131
 - nonreinforced, cloth, 129-130
 - paper, 129
 - plastic, 130
 - reinforced filament, 130-131
- Tape Clips,
 - "L" style, 38, 130, 133-136
 - "C" style, 130, 133-136
- Temperature, 41, 52, 58, 70-75
- Test methods, 48-51
 - damage boundary, 48-51, 68
 - drop test, 68
 - fragility testing, 48-51
 - revolving drum test,
 - pre-shipment testing, 48, 51, 53
- Ties, 3, 62, 96, 138, 139
 - application of, 138, 139
 - materials, 138
- Tobacco Products, 13
- Tools, 14
- Toys, 14
- Tubes, mailing, 25, 63, 80, 142-143
- Unitization, 89
- Unpackaged products, 63

Value, 41-45

Vibration, 2, 41, 46-48, 51, 59,
67-69

natural frequencies, 47, 48,
51, 68, 69

Weight, parcel, 41, 43, 54,
56, 63-65, 68

Weight, product, 45, 60

Wrapping, 94, 95, 98, 106-109,
116, 137

U.S. DEPT. OF COMM. BIBLIOGRAPHIC DATA SHEET	1. PUBLICATION OR REPORT NO. NBSIR 74-617	2. Gov't Accession No.	3. Recipient's Accession No.
4. TITLE AND SUBTITLE Packaging for Parcel Post		5. Publication Date November 1974	6. Performing Organization Code
7. AUTHOR(S) C. W. Hurley, L. G. Porter, J. J. Kramer, C.P. Goodman, M.L. Sirk		8. Performing Organ. Report No. NBSIR 74-617	
9. PERFORMING ORGANIZATION NAME AND ADDRESS NATIONAL BUREAU OF STANDARDS DEPARTMENT OF COMMERCE WASHINGTON, D.C. 20234		10. Project/Task/Work Unit No. 4314436	11. Contract/Grant No. 73-01268
12. Sponsoring Organization Name and Complete Address (Street, City, State, ZIP) Engineering Department U.S. Postal Service 475 L'Enfant Plaza West, S.W. Washington, D.C. 20260		13. Type of Report & Period Covered Final	14. Sponsoring Agency Code
15. SUPPLEMENTARY NOTES			
16. ABSTRACT (A 200-word or less factual summary of most significant information. If document includes a significant bibliography or literature survey, mention it here.) <p>The U.S. Postal Service has been implementing a program aimed at reducing damage to Parcel Post. One phase of this program concerns the relationship between packaging and parcel damage. This handbook describes the Parcel Post processing environment and presents specific packaging guidelines for frequent and large volume mailers of Parcel Post packages. Considerations involved in the packaging process are described. Types of containers; internal packaging materials; closing, sealing and reinforcing tapes; ties; banding and strapping are thoroughly covered. The handbook contains a Glossary of important parcel post and packaging terms and packaging references are also provided.</p>			
17. KEY WORDS (six to twelve entries; alphabetical order; capitalize only the first letter of the first key word unless a proper name; separated by semicolons) Damage reduction; packaging; Parcel Post			
18. AVAILABILITY <input type="checkbox"/> Unlimited <input checked="" type="checkbox"/> For Official Distribution. Do Not Release to NTIS <input type="checkbox"/> Order From Sup. of Doc., U.S. Government Printing Office Washington, D.C. 20402, SD Cat. No. C13 <input type="checkbox"/> Order From National Technical Information Service (NTIS) Springfield, Virginia 22151		19. SECURITY CLASS (THIS REPORT) UNCLASSIFIED	21. NO. OF PAGES 195
		20. SECURITY CLASS (THIS PAGE) UNCLASSIFIED	22. Price

DOCUMENT IMPROVEMENT PROPOSAL

Instructions: This sheet is to be filled out by either US Postal Service employees or mailers involved in the supervision of packaging or handling parcels or packaging materials procurement and/or packaging materials specifications.

Manufacturers/vendors who are prospective suppliers of packaging products are invited to submit constructive comments to the Postal Service and mail to the address indicated on the back of this form.

Comments submitted on this form do not constitute or imply authorization to waive any portion of the recommendations in this packaging handbook. Fold on lines on reverse side, staple the two open corners and mail to the address indicated. If there are additional papers, attach to this form and place both in an envelope and mail to the address shown on the back of this sheet.

Document Identification:
PACKAGING FOR PARCEL POST

Organization:
Address:

Telephone Number: Area Code

Submitted By:

Date:

1. Has this document created problems in interpretation?

A. Give page, paragraph and wording.

B. Recommendations to correct deficiencies or add information to make the packaging of parcel post more effective and an economical form of distribution.

F O L D

Return Address

PENALTY FOR PRIVATE
USE TO AVOID PAYMENT
OF POSTAGE, \$300



Mr. Norman E. Griffin
Program Manager, Packaging
US Postal Service
Engineering Department, Room 7940
475 L'Enfant Plaza
Washington, D.C. 20260

F O L D